

**Wisconsin
Administrative Code**

**Rules of
DEPARTMENT OF INDUSTRY,
LABOR AND
HUMAN RELATIONS**

1986-1987 EDITION

**BUILDING AND HEATING
VENTILATING AND AIR
CONDITIONING CODE**

Cite the rules in this Code as

▶ (for example)

s. ILHR 50.01, Wis. Adm. Code

**DEPARTMENT OF INDUSTRY, LABOR AND
HUMAN RELATIONS**

201 East Washington Avenue

Madison, Wisconsin 53702

608-266-3151

INTRODUCTION

Purpose and Structure

The Legislature, by s. 35.93 and ch. 227, Stats., directed the publication of the rules of administrative agencies having rule-making authority in a loose-leaf, continual revision system known as the Wisconsin Administrative Code. The Code is kept current by means of new and replacement pages. The pages are issued monthly, together with notices of hearings, notices of proposed rules, emergency rules, instructions for insertion of new material, and other information relating to administrative rules. This service is called the Wisconsin Administrative Register, and comes to the subscriber after the 10th and the 25th of each month. Code pages are issued to subscribers only with the end of the month Register. The editing and publishing of the Register and Code is done by the Revisor of Statutes Bureau, Suite 702, 30 W. Mifflin St., Madison, Wisconsin, 53703. (608-266-7275).

Availability

The complete code and the upkeep service are distributed to the county law libraries; to the libraries of the University of Wisconsin Law School and Marquette University Law School; to the State Historical Society; to the Legislative Reference Bureau and to the State Law Library, and to certain designated public libraries throughout the state.

The sale and distribution of the Register, Code and of its parts is handled by Department of Administration, Document Sales and Distribution, P.O. Box 7840, Madison, Wisconsin 53707. (608-266-3358)

Table of Contents

Each code with more than one chapter will have a table of chapters. After the title of each chapter will be the page numbers on which the chapter begins. Each chapter will have a table of sections. When a chapter has more than 10 sections and is over 10 pages in length the page number which that particular section begins on will be inserted after the title of the section.

History Notes

Each page of the code as it was originally filed and printed pursuant to the 1955 legislation, is dated "1-2-56". A rule which is revised or created subsequent to the original printing date is followed by a history note indicating the date and number of the Register in which it was published and the date on which the revision or creation of the rule became effective. The absence of a history note at the end of a section indicates that the rule has remained unchanged since the original printing in 1956. The date line at the bottom of the page indicates the month in which the page was released. Some common abbreviations used in the history notes are: cr. - created, am. - amend, r. - repeal, recr. - recreate, renum. - renumber, eff. - effective and emerg. - emergency.

In some instances an *entire* chapter has been repealed and recreated or renumbered subsequent to the original printing date. When this occurs a history note has been placed at the beginning of the chapter after the table of sections to contain this information. A separate history note appears after each section indicating the date when the revision became effective.

Index

The index for the complete Wisconsin Administrative Code will be found in the last volume. It will be recompiled, reprinted and distributed at least annually. Some codes have a separate index prepared by the agency involved. See the Building and Heating Code (chs. ILHR 50-64) for an example.

TABLE OF CONTENTS

<i>Chapter</i>	
ILHR 50	Administration and enforcement (p. 1)
ILHR 51	Definitions and standards (p. 19)
ILHR 52	General requirements (p. 103)
ILHR 53	Structural requirements (p. 139)
ILHR 54	Factories, office and mercantile buildings (p. 187)
ILHR 55	Theaters and assembly halls (p. 203)
ILHR 56	Schools and other places of instruction (p. 219)
ILHR 57	Residential occupancies (p. 229)
ILHR 58	Health care, detention and correctional facilities (p. 245)
ILHR 59	Hazardous occupancies (p. 277)
ILHR 60	Child day care facilities (p. 289)
ILHR 61	Community-based residential facilities (p. 299)
ILHR 62	Specialty occupancies (p. 311)
ILHR 63	Energy conservation (p. 337)
ILHR 64	Heating, ventilating and air conditioning (p. 355)
	Appendix A (p. 394)
	Appendix B (p. 448)
	Index (p. 458)

DEPT. OF INDUSTRY, LABOR & HUMAN RELATIONS

SUMMARY OF RULE CHANGES

Effective January 1, 1986

CHAPTER ILHR 50 — ADMINISTRATION and ENFORCEMENT

1. ILHR 50.02 — Cross reference error is corrected.
2. ILHR 50.02 Special Note #1 — Information regarding note and appendix material is added.
3. ILHR 50.03 (2) — This section no longer applies to alterations affecting natural lighting if the natural lighting is not required by code.
4. ILHR 50.04 (6) to (8) — Exemptions for buildings owned by the Federal Government, "bed and breakfast establishments" and certain, small CBRF are added.
5. ILHR 50.12 (4) (a) 1. (intro) — Grammatical correction made.
6. ILHR 50.20 — Language modified to reflect current terminology and cross reference format is corrected.

CHAPTER ILHR 51 — DEFINITIONS and STANDARDS

1. ILHR 51.01 — Definitions for the following terms have been added or amended: "Atrium", "Bed and Breakfast Establishment", "Direct Vent Sealed Combustion Chamber Appliance", "Interior Finish", "Penthouse", "Property Line", and "Rowhouse".
2. ILHR 51.02 (4) (c) 2.c. — Cross reference error corrected.
3. ILHR 51.02 (9) — Rules permitting imbedment of materials in fire resistive protection expanded and clarified.
4. ILHR 51.02 (11) (b) 3. — Rules regarding enclosure of stairways clarified.
5. ILHR 51.02 (13) (a) 1. — Rules regarding termination of fire division walls clarified.
6. ILHR 51.02 (13) (c) 2. — Rule limiting size of openings in fire division walls deleted.
7. ILHR 51.02 (14) (b) — Rule regarding size limitation of mezzanines lessened and clarified.
8. ILHR 51.02 (18) (b) — Application of rules regarding roof scuttles is clarified.
9. ILHR 51.03 (7) (f) — Setback rules for Type 7 construction are clarified.
10. ILHR 51.042 (7) — Rules for one-hour fire-resistive rated construction are clarified.
11. Table 51.044 — Table entries updated and expanded.
12. ILHR 51.06 (2) — Reference to adopted national standard updated.

WISCONSIN ADMINISTRATIVE CODE

13. ILHR 51.06 (3) (a) — Reference to adopted national standard updated.
14. ILHR 51.06 (4) (b) 3.b. — Reference to adopted national standard updated.
15. ILHR 51.06 (4) (c) 1. — Reference to adopted national standard updated.
16. ILHR 15.06 (4) (c) 3.b. — Reference to adopted national standard updated.
17. ILHR 51.06 (4) (e) 2. and 3. — Reference to adopted national standard updated.
18. ILHR 51.065 (1) (b) 1.a. and b. — Reference to adopted national standard updated.
19. ILHR 51.065 (2) (a) — Reference to adopted national standard updated.
20. Table 51.065-2 — Inconsistency with text of rule corrected.
21. ILHR 51.065 (6) (c) 2.a — Terminology corrected.
22. ILHR 51.065 (7) (a) 4.a — Reference to adopted national standard updated.
23. ILHR 51.065 (9) (a) 1. — Reference to adopted national standard updated.
24. ILHR 51.07 (6) (d) (intro) — Grammar and punctuation corrections.
25. ILHR 51.08 (2) (a) (intro) — Rule limiting size of opening in occupancy separation wall deleted.
26. ILHR 51.08 (2) (b) (intro) — Terminology corrected and rule limiting size of opening in occupancy separation wall deleted.
27. ILHR 51.14 (5) (a) — Cross reference error corrected.
28. ILHR 51.15 (3) (a) — Rule regarding height of exit hardware renumbered and made non-retroactive in application.
29. ILHR 51.15 (3) (e) 1. Rule permitting use of security bolts during non-occupied periods is reinstated.
30. ILHR 51.15 (3) (f) — See item number 28.
31. ILHR 51.15 (4) — Terminology corrected.
32. ILHR 51.151 — New rules regarding exit distribution inserted.
33. ILHR 51.16 (Title) — Rule expanded to include ramps.
34. ILHR 51.16 (1) — Rule expanded to include ramps.
35. ILHR 51.16 (2) — Rule expanded to include ramps.
36. ILHR 51.16 (3) (a) — Rule expanded to include ramps.
37. ILHR 51.16 (3) (b) — Rule expanded to include ramps.

DEPT. OF INDUSTRY, LABOR & HUMAN RELATIONS

38. ILHR 51.16 (3) (b) 2. — Stairway chair lifts now permitted on certain required exit stairs and lifts may infringe upon required exit width.
39. ILHR 51.16 (4) (Title) — Rule expanded to include ramps.
40. ILHR 51.16 (4) (f) — Rule expanded to include ramps.
41. ILHR 51.16 (4) (g) — Rule expanded to include ramps.
42. ILHR 51.16 (5) — Rule expanded to include ramps. Spaces beneath stairs and ramps may not be enclosed for any use.
43. ILHR 51.161 (1) (a) to (g) — Rule expanded to include ramps.
44. ILHR 51.161 (4) (b) — Rule renumbered and handrails on stairs in individual living units need not be provided with handrail extensions.
45. ILHR 51.24 (5) — Fire alarm testing reduced from weekly to monthly intervals.
46. ILHR 51.25 — Adopted ASTM Standards are updated.
47. ILHR 51.26 — Adopted ACI Standards are updated.
48. ILHR 51.27 (7) — Adopted NFPA Standards are updated.
49. ILHR 51.27 (6), (9), (10) and (15) — Adopted AWS, SJI, TPI and UL Standards are updated.
50. ILHR 51.27 (12) — Adoption of Federal HSS Standard for health care facility HVAC is updated to most recent edition.
51. ILHR 51.27 (13) — Adoption of ARI Standard for HVAC filters is deleted.

CHAPTER ILHR 52 — GENERAL REQUIREMENTS

1. ILHR 52.04 and Table 52.04 — Requirements for barrier free design have been expanded, amended or deleted to:
 - (A) Clarify curb ramp and accessible parking space location.
 - (B) Permit handrails to infringe upon required ramp width.
 - (C) Clarify and update handrail rules for interior and exterior ramps.
 - (D) Clarify rules regarding accessible seating spaces.
 - (E) Eliminate exception for church entrance remodeling.
 - (F) Reduce the required number of accessible units in hotels/motels not providing meeting or conference room facilities.
 - (G) Clarify water closet compartment rules.
 - (H) Clarify and expand grab bar rules.
 - (I) Reduce the height limitation for accessible water closets to 17" to 19" above the floor.
 - (J) Regulate the height of accessible wall hung urinals.
 - (K) Clarify rules for accessible public telephones.
 - (L) Establish comprehensive rules for atrium construction are added.

WISCONSIN ADMINISTRATIVE CODE

2. ILHR 52.07 — New comprehensive rules for atrium construction are added.

3. ILHR 52.60 (2) (b) Note 3 — Note cross referencing wall hung urinal rule with accessibility rule added.

4. ILHR 52.60 (2) (f) — Rule for floor drain in conjunction with wall hung urinals is deleted to be consistent with Plumbing Code.

5. ILHR 52.60 (3) (b) — Limitation of use of warm air hand dryers is repealed.

6. ILHR 52.60 (5) (a) — Rule regarding size of showers amended to be consistent with Plumbing Code.

CHAPTER ILHR 53 — STRUCTURAL REQUIREMENTS

1. ILHR 53.63 (10) — Rules for solid blocking in wood frame construction are clarified.

CHAPTER ILHR 54 — FACTORIES, OFFICES and MERCANTILE BUILDINGS

1. ILHR 54.01 (2) (b) 1. — Rules for partition construction in unlimited area buildings of type 3 or 4 construction are clarified.

2. ILHR 54.01 (2) (b) 2. — Rules for stair construction in unlimited area buildings of type 5 or 6 construction are clarified.

3. ILHR 54.01 (2) (b) 3. — Construction rules for unlimited area buildings of totally noncombustible construction and having totally noncombustible contents are clarified.

4. ILHR 54.01 (2) (c) and (d) — Rules are renumbered and amended to permit fully sprinklered 2 story buildings to Types 2, 3, 4, 5 or 6 construction to be of unlimited area provided the area of the second story does not exceed $\frac{1}{2}$ the area of the first story.

5. ILHR 54.11 (1) — Format and cross reference corrections are made.

6. Tables 54.-A and 54.12-B — Rules for determining the required number of lavatories are modified and based upon the required number of fixtures.

7. ILHR 54.12 (2) (a) 1. — Rules for determining the number of sanitary fixtures in small restaurants are relaxed.

8. ILHR 54.14 (1) — Direct vent sealed combustion equipment is permitted without a fire-resistive rated enclosure.

9. ILHR 54.22 (6) — rules for permitted openings in mini warehouse buildings are lessened.

10. ILHR 54.23 — Rules for freezer warehouse buildings are relocated to s. ILHR 54.01 (2) and cross references are corrected.

CHAPTER ILHR 55 — THEATERS and ASSEMBLY HALLS

1. ILHR 55.001 — Scope of chapter is created.

2. ILHR 55.01 — Definition section for the chapter is created.

DEPT. OF INDUSTRY, LABOR & HUMAN RELATIONS

3. ILHR 55.02 (2) (a) to (c) — Rules are renumbered and reworded for clarity in application.

4. ILHR 55.07 (1) — Rule format is corrected.

5. ILHR 55.09 (2) — Rooms under stairways in ch. ILHR 55 building are no longer permitted.

6. ILHR 55.09 (3) — Rules redundant with s. ILHR 51.16 are deleted. A maximum of 22 risers in any one stairway flight is now permitted.

7. ILHR 55.10 (4) — Rules for level platforms at exit doors are clarified.

8. ILHR 55.22 (3) — Size limitations for fire doors are deleted.

9. ILHR 55.29 (1) — Direct vent sealed combustion equipment is permitted without a fire-resistive rated enclosure.

10. Table 55.32 — Rules for determining the required number of lavatories are modified and based upon the required number of fixtures.

CHAPTER ILHR 56 — SCHOOLS and OTHER PLACES OF INSTRUCTION

1. ILHR 56.15 (1) (intro) — Direct vent sealed combustion equipment is permitted without a fire-resistive rated enclosure.

CHAPTER ILHR 57— RESIDENTIAL OCCUPANCIES

1. ILHR 57.001 (2) (i) — Exemption for “Bed and Breakfast Establishments” is added to scope of chapter.

2. ILHR 57.01 (2) — Less restrictive, performance oriented rules for living unit separations are added.

3. ILHR 57.02 (3) (a) 1. — Access roadway rules for buildings 3 stories or less in height are lessened.

4. ILHR 57.03 (1) — Rules for number of exits, exit access, and direction of travel from living units and congregate living facilities are clarified.

5. ILHR 57.07 (3) — Rules for changes of elevation within living units are modified based upon recent changes in the Uniform Dwelling Code.

6. ILHR 57.13 (1) (a) — Rules for windows in living units are clarified.

7. ILHR 57.14 (1) (c) 5. — Direct vent sealed combustion equipment is permitted without a fire-resistive rated enclosure.

8. ILHR 57.16 (1) (a) — Rules for expanded smoke detector protection in CBRF are added per 1983 Wisconsin Act 363.

9. ILHR 57.165 — Rules for expanded smoke detector protection in CBRF are added per 1983 Wisconsin Act 363.

10. ILHR 57.19 (1) — Rules for vertical occupancy separations between rowhouse units are relocated from the definition section.

WISCONSIN ADMINISTRATIVE CODE
CHAPTER ILHR 58 — HEALTH CARE, DETENTION
and CORRECTIONAL FACILITIES

HEALTH CARE FACILITIES

1. ILHR 58.01 (1) (intro) and (d) — Fully sprinklered buildings up to 3 stories in height of type 3 construction may now be used for health care facility purposes.
2. ILHR 58.02 (5) — Rules for exiting from mixed occupancy buildings are added.
3. ILHR 58.02 (2) (c) — Unenclosed non-required exit stairs and ramps connecting different levels within the same floor are permitted.
4. ILHR 58.07 — Language of rule clarified.
5. ILHR 58.11 (3) — Intent of rule clarified.
6. ILHR 58.13 (2) and (3) — rules renumbered and rule for permitted dead end corridors is added.
7. ILHR 58.15 — Exterior stairs or ramps used as required exits must be enclosed.
8. ILHR 58.22 — Rules for elevator lobby enclosures are clarified.
9. ILHR 58.29 — (1) (b) — Rules for automatic fire sprinkler protection in nursing homes are clarified.

DETENTION AND CORRECTIONAL FACILITIES

10. ILHR 58.44 (4) — Rules for exiting from a mixed occupancy building are added.
11. ILHR 58.50 (1) — Rules for exiting and permitting use of non-required convenience stairs are added or clarified.
12. ILHR 58.55 (6) — Rules for permitted dead end corridors are added.
13. ILHR 58.59 (2) — Rules regarding release of locks are amended to be consistent with NFPA Standard 101.
14. ILHR 58.69 (1) — Rules for guard tower construction are lessened.

CHAPTER ILHR 59 — HAZARDOUS OCCUPANCIES

1. ILHR 59.12 (4) — Rules for permitted openings in mini-garage buildings are lessened.
2. ILHR 59.13 (2) (d) — Rules for exit doors in garages are clarified.
3. ILHR 59.21 (intro) — Direct vent sealed combustion equipment is permitted without a fire-resistive rated enclosure.
4. ILHR 59.21 (3) — Rules for permitted use of suspended heating equipment are added.

CHAPTER ILHR 60 — CHILD DAY CARE FACILITIES*

1. ILHR 60.001 (5) — School age day care programs are now permitted in school buildings meeting the rules of ch. ILHR 56.

DEPT. OF INDUSTRY, LABOR & HUMAN RELATIONS

2. ILHR 60.15 (1) (b) and (e) — Age limitation of children for determining the number of needed sanitary fixtures is changed from 30 to 24 months to be consistent with DHSS Licensing rules.

3. ILHR 60.23 (3) — Rules permitting unenclosed stairways are lessened and clarified.

4. ILHR 60.31 (4) — Age limitation of children for determining travel distance to exits is changed from 30 to 24 months to be consistent with DH&SS Licensing Rules.

5. ILHR 60.25 (1) (intro) — Direct vent sealed combustion equipment is permitted without a fire-resistive rated enclosure.

6. ILHR 60.34 — Stair and shaft enclosure rules are modified and exceptions are added.

*Rule changes in Chapter ILHR 60 became effective 9/1/85.

CHAPTER ILHR 61 — COMMUNITY-BASED RESIDENTIAL FACILITIES

1. ILHR 61.14 — Expanded smoke detection rules per 1983 Wisconsin Act 363 are added.

2. ILHR 61.20 — The size of required fire extinguishers is reduced.

*Rule changes in Chapter ILHR 61 became effective on 9/1/85.

CHAPTER ILHR 62 — SPECIALTY OCCUPANCIES

OPEN PARKING STRUCTURES

1. ILHR 62.32 (1) — Direct vent sealed combustion equipment is permitted without a fire-resistive rated enclosure.

ASSEMBLY SEATING FACILITIES

2. ILHR 62.78 — Direct vent sealed combustion equipment is permitted without a fire-resistive rated enclosure.

PEDESTRIAN ACCESS STRUCTURES

3. Subchapter VII — New Rules for pedestrian access structures connecting buildings (including skywalks) are added.

CHAPTER ILHR 63 — ENERGY CONSERVATIVE

1. Table 63.11 — Application of door/window infiltration rules to residential buildings is clarified.

2. ILHR 63.11 (3) (c) 1. — Reference to adopted standard is updated.

3. ILHR 63.12 (1) (b) 1. — Application of door/window infiltration rules to residential buildings is clarified.

4. ILHR 63.40 — Rules regarding power factor correction for motors are deleted.

CHAPTER ILHR 64 — HEATING, VENTILATING AND AIR CONDITIONING

1. ILHR 64.05 Table 1 — Rules for laundry rooms and toilet rooms in conjunction with outdoor stadiums are added.

WISCONSIN ADMINISTRATIVE CODE

2. ILHR 64.21 — Format of rule modified.
3. Table 64.21 — Gas- and oil-fired infrared equipment divided into 2 classifications. Column for direct vent sealed combustion equipment added. Expanded use of closed combustion infrared equipment, unit heaters and suspended furnaces permitted. Guarding of equipment in lieu of suspending is no longer permitted.
4. ILHR 64.22 (1) — Cross reference corrected.
5. ILHR 64.22 (3) (intro) — Permitted use of suspended equipment in multi-tenant buildings is clarified.
6. ILHR 64.22 (3) (a) and (9) — Application of rule for heat exchanger corrosion protection is expanded.
7. ILHR 64.22 (4) — Rule regarding amount of ventilation needed for unvented heaters is clarified.
8. ILHR 64.22 (6) — Cross reference corrected.
9. ILHR 64.34 (1) and (3) (e) — Use of duct liners and combustible ducts in conjunction with metallic ducts is clarified.
10. ILHR 64.41 (4) (b) — Cross reference corrected.
11. ILHR 64.50 (1) (c) — Reference to adopted national standard inserted.
12. ILHR 64.50 (1) (g) 2. — Technical correction.
13. Table 64.50 — Misspelling corrected.
14. ILHR 64.51 (1) — Adoption of NFPA Standard 211 updated to current edition.
15. Tables 64.51-A, B, C, D — Reprinted tables from NFPA Standard 211 deleted.
16. ILHR 64.57 (2) to (4) — Adoption of Federal standard for health care facility HVAC systems is updated to current edition. Exceptions to old standard are deleted.
17. ILHR 64.62 — Rules for vehicle service buildings are clarified.
18. ILHR 64.65 (1) Note #5 — Note regarding permitted energy recovery systems is added.
19. ILHR 64.65 (2) — Combining of certain exhaust systems is now permitted.

APPENDIX A

1. A51.151 — Drawings and diagrams depicting acceptable exit distribution layouts are added.
2. A51.22 — Fire extinguisher information is updated per most recent edition of NFPA Standard 10.
3. A53.11 (4) (b) and (e) — Appendix material is renumbered to correspond to correct rule number.
4. A57.07 (3) — Reprint of s. ILHR 21.04 is updated to reflect recent rule changes.

DEPT. OF INDUSTRY, LABOR & HUMAN RELATIONS

5. A64.57 — Reprint of former Federal standard for health care facility HVAC design is deleted.

APPENDIX B

1. "FP" designations, references and text are updated to reflect new and amended rules.

Chapter ILHR 50

ADMINISTRATION AND ENFORCEMENT

Part I—Purpose and Scope	
ILHR 50.01 Purpose of code (p. 1)	ILHR 50.14 Permission to start construction (p. 12)
ILHR 50.02 Scope of chapters (p. 1)	ILHR 50.15 Evidence of plan approval (p. 12)
Part II—Application of Building Code	ILHR 50.16 Revocation of approval (p. 12)
ILHR 50.03 Application (p. 2)	ILHR 50.17 Expiration of plan approval and extension of plan approval (p. 12)
ILHR 50.04 Buildings exempt from code requirements (p. 3)	ILHR 50.175 Department limitation (p. 13)
ILHR 50.05 Existing buildings code (p. 3)	ILHR 50.18 Inspections (p. 13)
ILHR 50.06 Local regulations (p. 4)	ILHR 50.19 Approval of materials, equipment and devices (p. 13)
Part III—Design and Supervision	ILHR 50.20 Fees (p. 13)
ILHR 50.07 Design (p. 4)	Part V—First Class City and Certified Municipal Approvals
ILHR 50.08 Plans, specifications and calculations prepared outside Wisconsin (p. 5)	ILHR 50.21 Agent municipalities and counties (p. 14)
ILHR 50.09 Changes to plans and specifications (p. 5)	Part VI—Enforcement, Petition for Variance, Appeals and Penalties
ILHR 50.10 Supervision (p. 5)	ILHR 50.23 Enforcement (p. 16)
ILHR 50.11 Owner's responsibility (p. 6)	ILHR 50.24 Appeals (p. 16)
Part IV—Department Approval	ILHR 50.25 Petition for variance (p. 17)
ILHR 50.12 Plan examination and approval (p. 6)	ILHR 50.26 Penalties (p. 17)
ILHR 50.125 Wisconsin insignia (p. 11)	
ILHR 50.13 Footing and foundation approval (p. 12)	

Note: Chapter Ind 50 as it existed on December 31, 1976, was repealed and a new chapter Ind 50 was created effective January 1, 1977; chapter Ind 50 was renumbered to be chapter ILHR 50, effective January 1, 1984.

Part I—Purpose and Scope

ILHR 50.01 Purpose of code. The purpose of this code is to protect the health, safety and welfare of the public and employes by establishing minimum standards for the design, construction, structural strength, quality of materials, adequate egress facilities, sanitary facilities, natural lighting, heating and ventilating, energy conservation, and fire safety for all public buildings and places of employment.

Note 1: The purpose as stated can be traced to the terms used in the "safe place" statutes, ch. 101, Stats.

Note 2: This code is intended for the protection of the public and is not intended as a design manual, a textbook or a construction manual.

History: Cr. Register, December, 1976, No. 252, eff. 1-1-77.

ILHR 50.02 Scope of chapters. The provisions of chs. ILHR 50-64 apply to all public buildings and places of employment. The provisions of these chapters are not retroactive unless specifically stated in the administrative rule. Where different sections of these chapters specify different requirements, the most restrictive requirement shall govern, except as

specified in ss. ILHR 51.02 (11) (b) 4., 52.012, 52.013, 58.001 (2) (c), 62.93 and 64.57 (4).

Note: For a definition of "public building" and "place of employment," see ss. ILHR 51.01 (102b) and 51.01 (104a) or s. 101.01 (2), Stats.

History: Cr. Register, December, 1976, No. 252, eff. 1-1-77; am. Register, December, 1981, No. 312, eff. 1-1-82; am. Register, October, 1982, No. 322, eff. 11-1-82; am. Register, December, 1983, No. 336, eff. 1-1-84; am. Register, August, 1985, No. 356, eff. 1-1-86; emerg. am. eff. 9-6-86; am. Register, November, 1986, No. 371, eff. 12-1-86.

SPECIAL NOTE #1

AN ASTERISK (*) FOLLOWING THE SECTION OR SUBSECTION NUMBER INDICATES EXPLANATORY MATERIAL ON THAT PARAGRAPH MAY BE FOUND IN APPENDIX A. EXAMPLE: ILHR 51.01 (16)* — SEE A-51.01 (16) IN APPENDIX A. THE MATERIAL CONTAINED IN THIS APPENDIX AND THE NOTES FOUND IN THE CODE ARE NOT PART OF THE ENFORCEABLE RULES OF THIS CODE AND ARE PROVIDED FOR INFORMATION AND CLARIFICATION PURPOSES ONLY.

SPECIAL NOTE #2

THE OVERALL ENFORCEMENT RESPONSIBILITY FOR ALL OF THE PROVISIONS OF THIS CODE IS EQUALLY SHARED BY THE BUILDING INSPECTOR AND THE FIRE INSPECTOR. NORMALLY, THE BUILDING INSPECTOR HAS PRIMARY RESPONSIBILITY DURING CONSTRUCTION OF THE BUILDING WHILE THE FIRE INSPECTOR HAS PRIMARY RESPONSIBILITY AFTER THE BUILDING IS COMPLETED. THE ENFORCEMENT OF MANY OF THE PROVISIONS OF THE CODE IS THE PRIMARY RESPONSIBILITY OF THE FIRE INSPECTOR AND COMPLIANCE WITH THESE PROVISIONS SHOULD BE OF PRIMARY CONCERN WHILE CONDUCTING THE FIRE PREVENTION INSPECTIONS MANDATED BY SECTION 101.14, STATS. A GUIDELINE FOR THIS TOPIC HAS BEEN PREPARED. THE LETTERS "FP" MEANING FIRE PREVENTION AND APPEARING IN THE MARGIN ADJACENT TO A RULE INDICATES THE PRIMARY ENFORCEMENT RESPONSIBILITY FOR THE RULE IS THAT OF THE FIRE INSPECTOR. FURTHER EXPLANATORY MATERIAL FOR THE INDICATED RULES MAY BE FOUND IN APPENDIX B. EXAMPLE: SEE S. ILHR 51.20 AND APPENDIX B.

Part II—Application of Building Code

ILHR 50.03 Application. (1) **NEW BUILDINGS AND ADDITIONS.** The provisions of this code shall apply to all new buildings and structures, and also to additions to existing buildings and structures, except those indicated in s. ILHR 50.04.

(2) **ALTERATIONS TO BUILDINGS.** The provisions of this code shall apply to all remodeling or alterations in any building or structure which affect the structural strength, fire hazard, exits, required natural lighting or replacement of major equipment. These provisions do not apply to minor repairs necessary for the maintenance of any building or structure nor to buildings exempt, as listed in s. ILHR 50.04.

(3) **CHANGE OF USE.** (a) If the use of an existing building or structure is changed in accordance with the definition of s. ILHR 51.01 (87), and the requirements for the new use are more stringent than those for the previous use, the building or structure shall be made to comply with the requirements for the new use as provided in this code.

1. **Exception.** Unless the requirements for the new use are modified subject to the written approval by the department.

2. **Exception.** An existing building undergoing a change of use will not be required to comply with the provisions of s. ILHR 52.04—barrier-free environments, unless the building undergoes physical remodeling in accordance with the percentages established in s. ILHR 52.04 (6).

(b) If, upon inspection of an existing building or structure, it is found that its use has changed and that it does not comply with the requirements of the building code in effect at the time of change, it shall be made to comply with the code requirements in effect at the time of change in use.

History: Cr. Register, December, 1976, No. 252, eff. 1-1-77; am. (2), Register, August, 1985, No. 356 eff. 1-1-86.

ILHR 50.04 Buildings exempt from code requirements. This code does not apply to the following types of buildings:

(1) One- and 2-family dwellings and outbuildings in connection therewith such as barns and private garages.

(2) Buildings used exclusively for farming purposes.

Note: For a definition of "farming," see s. 102.04 (3), Stats.

(3) Buildings used primarily for housing livestock or for other agricultural purposes, located on research or laboratory farms of public universities or other state institutions.

(4) Temporary buildings, used exclusively for construction purposes, not exceeding 2 stories in height, and not used as living quarters.

(5) Buildings located on Indian reservation land held in trust by the United States.

(6) Buildings owned by the federal government. Buildings owned by other than the federal government and leased to the federal government are not exempt.

(7) Bed and breakfast establishments as defined in s. ILHR 51.01 (11a).

(8) Community-based residential facilities located in existing buildings and providing care, treatment and services to 3 to 8 unrelated adults.

History: Cr. Register, December, 1976, No. 252, eff. 1-1-77; am. (2) and cr. (6), Register, December, 1977, No. 264, eff. 1-1-78; cr. (6) to (8), Register, August, 1985, No. 356 eff. 1-1-86.

ILHR 50.05 Existing buildings code. Buildings and structures erected prior to the effective date of the first building code (October 9, 1914) shall comply with the general orders on existing buildings, chs. Ind 160-164,

issued by the department. Buildings and structures constructed after October 9, 1914, shall comply with the code in effect at the time.

History: Cr. Register, December, 1976, No. 252, eff. 1-1-77.

ILHR 50.06 Local regulations. (1) This code shall not limit the power of cities, villages and towns to make, or enforce, additional or more stringent regulations, provided the regulations do not conflict with this code, or with any other rule of the department, or law.

(2) Exception. Pursuant to s. 101.75 (2), Stats., all manufactured multi-family dwellings approved by the department shall be deemed to comply with the requirements of all building ordinances and regulations of any local government except those related to zoning and siting requirements including, but not limited to, building setback, side and rear yard requirements and property line requirements.

Note: This exception applies only to those building elements and building parts covered under the provisions of s. ILHR 50.125 Wisconsin Insignia. The exception does not apply to on-site constructed elements such as, but not limited to, footings, foundations, attached porches, steps, concrete floor slabs and on-site constructed mechanical systems.

History: Cr. Register, December, 1976, No. 252, eff. 1-1-77; cr. (1), Register, May, 1980, No. 293, eff. 6-1-80.

Part III—Design and Supervision

ILHR 50.07 Design. Every new building, or alteration to a building, shall be designed in compliance with this code.

(1) **BUILDINGS CONTAINING NOT MORE THAN 50,000 CUBIC FEET TOTAL VOLUME.** The plans and specifications for every new building, or alteration to a building, containing not more than 50,000 cubic feet total volume, or addition to a building in which the volume of the addition results in the entire building containing not more than 50,000 cubic feet total volume, may be prepared by a registered architect, engineer, designer, contractor or an authorized agent.

(2) **BUILDINGS CONTAINING MORE THAN 50,000 CUBIC FEET TOTAL VOLUME.** The plans and specifications for every new building, or alteration to a building, containing more than 50,000 cubic feet total volume, or addition to a building in which the volume of the addition results in the entire building containing more than 50,000 cubic feet total volume, shall be designed as follows:

(a) *Building or structural design.* The plans and specifications for the design of the building or structure shall be prepared, signed and sealed by a Wisconsin registered architect or engineer.

(b) *Heating, ventilating and air conditioning design.* The plans and specifications for the heating, ventilating and air conditioning system shall be prepared, signed and sealed by a Wisconsin registered architect, engineer or designer.

(c) *Energy conservation design.* The plans and specifications for energy conservation design shall be prepared, signed and sealed by a Wisconsin registered architect, engineer or designer.

Note 1: See s. ILHR 51.01 (139a) for definition of total volume.

Note 2: The above terms "registered architect, engineer or designer" mean registered architect, registered professional engineer or registered designer as defined by laws regulating the Register, December, 1985, No. 360

practice of engineering and architecture found in ch. 443, Stats. Registered designers are limited to the specific designations outlined in s. A-E 1.20. See s. A-E 1.04 for rules pertaining to signing, sealing and dating of plans prepared by registered architect, engineer or designer.

Note 3: According to s. 87.30, Stats., the construction or placement of every building, structure, fill or development placed or maintained within any flood plain is required to satisfy local or state regulations.

(3) **ANTENNAS AND SUPPORTING TOWERS EXCEEDING 200 FEET IN HEIGHT.** The plans and specifications for antennas and supporting towers exceeding 200 feet in height shall be prepared, signed and sealed by a Wisconsin registered architect or engineer.

History: Cr. Register, December, 1976, No. 252, eff. 1-1-77; am. (2) (a) and (b), cr. (2) (c), Register, December, 1978, No. 276, eff. 1-1-79; am. (1), Register, December, 1981, No. 312, eff. 1-1-82; cr. (3), Register, December, 1983, No. 336, eff. 1-1-84; am. (2) (c), Register, December, 1985, No. 360, eff. 1-1-86.

ILHR 50.08 Plans, specifications and calculations prepared outside Wisconsin. Plans, specifications and calculations for buildings and structures under s. ILHR 50.07 (2) and (3), may be prepared by an architect or engineer registered outside of the state of Wisconsin, provided the following conditions are satisfied:

(1) **SEAL.** The plans, specifications and calculations shall bear the signature and seal or stamp of the architect or engineer registered in a state other than Wisconsin.

(2) **CERTIFICATE.** A certificate, dated, signed and sealed by an architect or engineer registered in Wisconsin, shall be attached to the plans, specifications and calculations. The certificate shall indicate that the plans, specifications and calculations were prepared in a state other than Wisconsin by an architect or professional engineer registered in that state; describe the work performed by the Wisconsin registered architect or engineer; and include statements to the effect that the plans and specifications have been reviewed and comply with all applicable local and state buildings codes, and that the reviewing architect or engineer will be responsible for the supervision of construction in accordance with the requirements of s. ILHR 50.10.

History: Cr. Register, December, 1976, No. 252, eff. 1-1-77; am. (intro.), Register, December, 1983, No. 336, eff. 1-1-84.

ILHR 50.09 Changes to plans and specifications. No change in plans or specifications, which involve any provisions of this code, shall be made unless such change is signed, sealed and dated by the architect, engineer or designer who made the change, and approved by the department.

History: Cr. Register, December, 1976, No. 252, eff. 1-1-77.

ILHR 50.10 Supervision. All constructions or installations under s. ILHR 50.07 (2) and (3) shall be supervised by a Wisconsin registered architect or engineer, except that a Wisconsin registered designer may supervise the installation of heating, ventilating and air conditioning systems and illumination systems. The person responsible for supervision shall also be responsible for the construction and installation being in substantial compliance with the approved plans and specifications. Should the supervising architect, engineer, designer, or the department, be confronted with a nonconformance to the code during, or at the end of, construction, said parties, together with the designing architect, engineer or designer shall effect compliance or shall notify the department of the noncompliance.

(1) **DEFINITION.** Supervision of construction is a professional service, as distinguished from superintending of construction by a contractor, and means the performance, or the supervision thereof, of reasonable on-the-site observations to determine that the construction is in substantial compliance with the approved plans and specifications.

(2) **NAME OF SUPERVISING ARCHITECT, ENGINEER OR DESIGNER.** Prior to the start of construction, the owner of the building or structure, whose name must be a part of, or accompany, all plans submitted for approval, as required by s. ILHR 50.12 or an authorized agent, shall designate to the department, in writing, the name and registration number of the architect, engineer or designer retained to supervise construction of the building or structure.

(3) * **COMPLETION STATEMENT.** Upon completion of the construction, the supervising architect, engineer or designer shall file a written statement with the department certifying that, to the best of his or her knowledge and belief, construction has been performed in substantial compliance with the approved plans and specifications.

History: Cr. Register, December, 1976, No. 252, eff. 1-1-77; am. (intro.) and (2), Register, December, 1981, No. 312, eff. 1-1-82; am. (intro.), Register, December, 1983, No. 336, eff. 1-1-84.

ILHR 50.11 Owner's responsibility. No owner shall construct or alter any building or structure, or portion of a building or structure, or permit any building or structure to be constructed or altered except in compliance with the provisions of ss. ILHR 50.07, 50.08, 50.09, 50.10 and 50.12. Compliance with the provisions of this section does not relieve the owner from compliance with the administrative rules established in other related codes.

Note: For definition of owner, refer to s. 101.01 (2) (e), Stats.

History: Cr. Register, December, 1976, No. 252, eff. 1-1-77.

Part IV—Department Approval

ILHR 50.12 Plan examination and approval. (1) **TYPES OF BUILDINGS.** Plans and specifications for all buildings and structures in the following classifications shall be submitted to the department or its authorized representative, as provided in s. ILHR 50.21, for examination and approved before commencing work:

Note 1: See the scope of the occupancy chapters for examples of specific types of buildings covered in pars. (a) through (f).

Note 2: Section 101.12 (3) (h), Stats., prohibits local issuance of permits or licenses for construction or use of public buildings or places of employment until drawings and calculations have been examined and approved by the department.

(a) **Factories, office and mercantile buildings** (ch. ILHR 54).

1. Department examination and approval for factories, office and mercantile buildings containing less than 25,000 cubic feet total volume is waived; however, the buildings shall comply with the applicable requirements of this code.

(b) **Theaters and assembly halls** (ch. ILHR 55).

*See Appendix A for further explanatory material.

- (c) Schools and other places of instruction (ch. ILHR 56).
 - (d) Apartment buildings, hotels, motels and places of abode (ch. ILHR 57).
 - (e) Health care facilities and places of detention (ch. ILHR 58).
 - (f) Hazardous occupancies (ch. ILHR 59). Plan submission for hangars storing one airplane is not required.
 - (g) Day care facilities (ch. ILHR 60).
 - (h) Community-Based Residential Facilities (CBRF) (ch. ILHR 61).
 - (i) 1. a. Except as provided in subpar. b., department examination and approval is waived for television and radio transmitting and receiving antennas, outdoor theater screens, water tanks, display signs, observation towers, docks, piers, wharves, tents or inflatable structures used temporarily, and other similar structures; however, these structures and temporary tents shall comply with the applicable structural and other requirements of chs. ILHR 50-64.
 - b. 1. Plan examination and approval is required for the installation of roof mounted antenna structures exceeding 20 feet in height above the roof, unless the building is otherwise exempt or plan submittal is waived.
 - 2. Plan examination and approval is required for the installation of ground mounted antenna structures exceeding 200 feet in height.
 - 3. Plan examination and approval is required for the installation of ground mounted antenna structures exceeding 50 feet in height if the structure is located nearer to any street, public thoroughfare or property line than the height of the structure measured from its base of the structure nearest to the street, thoroughfare or property line to the topmost point.
- (2) TYPES OF PLAN APPROVAL. The following types of plans shall be submitted to the department or its authorized representative, as provided in s. ILHR 50.21, for examination and approval before construction is commenced:
- (a) General building plans.
 - (b) Structural plans.
 - (c) Heating and ventilating plans.
 - 1. The addition of air-cooling equipment to an approved heating system requires department approval of energy conservation provisions.
 - 2. The replacement of a major piece of heating or air conditioning equipment is subject to written approval by the department.
 - (d) Alteration plans for existing buildings, except for those alterations involving changes in interior finishes only.
 - (e) Revisions to previously examined plans.
 - (f) Exhaust system plans (government-owned buildings only).
 - (g) Spray booth plans (government-owned buildings only).
 - (h) Footing and foundation plans (see s. ILHR 50.13).

- (i) Assembly seating facility plans.
- (j) Fire escape plans.

(3) **PLANS AND SPECIFICATIONS.** At least 4 complete sets of plans, which are clear, legible and permanent copies, and one copy of specifications shall be submitted for examination and approval before commencing construction. The plans and specifications shall contain the following information:

Note: Also see sub. (5)(b) note.

(a) *General.* All plans shall contain the name of the owner and the address of the building. The name and seal of the architect(s), engineer(s) or person(s) who prepared the plans shall appear on the title sheet, in accordance with s. A-E 1.04 (4), Wis. Adm. Code — registration seals.

(b) *General building plans.* The general building plans shall include the following:

1. **Plot plan.** The location of the building with respect to property lines and/or lot lines and/or adjoining streets, alleys and any other buildings on the same lot or property shall be indicated on the plot plan. A small scale plot plan shall be submitted on a 8½" x 11" sheet for projects containing multiple buildings.

2. **Floor plans.** Floor plans shall be provided for each floor. The size and location of all rooms, doors, windows, firewalls, toilet facilities, structural features, exit passageways, exit lights, fire alarms, standpipes, stairs and other pertinent information shall be indicated. Schematic exit plans shall be provided for large buildings, indicating normal paths of egress.

3. **Elevations.** The elevations shall contain information on the exterior appearance of the building and indicate the location and size of doors, windows, roof shape, chimneys, exterior grade, footings and foundation walls, and include information about the exterior materials.

4. **Sections and details.** Sections and details shall include information to clarify the building design.

(c) *Heating, ventilating and air conditioning plans.* Heating, ventilating and air conditioning plans shall indicate the layout of the system, including location of equipment and size of all piping, ductwork, dampers (including fire dampers), chimneys, vents and controls. The quantity of outside air introduced to each zone, and the quantity of supply air and exhaust air for each room shall be listed on the plans. The type of equipment and capacity (including the input and output) shall be indicated on the plans or equipment schedules, unless indicated in the specifications.

(d) *Specialty plans.* Specialty plans for spray booths, special exhaust systems, assembly seating facilities, fire escapes and special structural systems shall include pertinent information with respect to the design and construction of the specialty.

(e) *Specifications.* The specifications shall be properly identified with the drawings and describe the quality of the materials and the workmanship.

(f) *Schedules.* Schedules shall be provided which contain information pertinent to doors, room finishes, equipment, and the use of all rooms and the number of occupants accommodated therein, unless this information is indicated on the plans.

Note 1: Original drawings are not considered a substitute for permanent prints.

Note 2: Duplicate information need not be submitted when heating, ventilating, air conditioning and building plans are submitted simultaneously.

Note 3: For pit depth and overhead clearance requirements applicable to design of elevator hoistways, see ch. Ind 4, Elevator Code.

Note 4: Plans for swimming pool installations are examined by the department of health and social services.

(4) **DATA REQUIRED.** All plans submitted for approval shall be accompanied by sufficient data and information for the department to judge if the design of the building, the capacity of the equipment, and the performance of the system will meet the requirements of this code. The following data shall be submitted:

(a) *Structural data.* Sample structural calculations, including assumed bearing value of soil, live loads and itemized dead loads, unit stresses for structural materials, typical calculations for slabs, beams, girders, columns and trusses shall be submitted. Typical wind and bracing calculations and diagrams including the manner in which shear transfer is made between resisting elements shall also be included. Complete structural calculations shall be furnished upon request of the department or other authorized approving official.

1. The building designer shall submit the following minimum information for structural components such as but not limited to wood trusses, precast concrete, laminated wood members, steel joists and steel girders when the component fabricator is specified as being responsible for the component design:

- a. Structural framing plan;
- b. Bearing support and connection details of the component to the structure;
- c. Design loads, including location and magnitude of: uniform superimposed dead and live loads; concentrated dead and live loads; nonuniform snow loads; wind and bracing loads for component system; and wind, bracing and gravity forces required to be developed at interfaces with other materials;
- d. Required fire rating;
- e. Outside configuration of components; and
- f. Permanent bracing system.

2. The building designer shall also submit the following information with the initial building plan submittal or the component plan submittal:

- a. A framing plan showing all members and labels and special installation (e.g., handling and erection) instructions and any required permanent bracing required which was the basis for the component design;

b. Information regarding the member design of the following structural components: Web configuration, stress diagram or tabulation of axial force in the members, member size, grade of lumber, fabricated splices and member bracing for wood trusses; Web configuration, stress diagram or tabulation of axial force in the members, member size, steel yield, fabricated splices and member bracing for steel joists and joist girders subjected to nonuniform loading; Specified concrete strengths, prestressing data including final effective forces and centroids, mild reinforcing including release and confinement steel, shear reinforcing, and stripping, transportation and erection handling points for precast concrete members; Species of wood, bending stress of wood, adhesive and member sizes for laminated wood members; and

c. Information pertaining to the design of connections within or between like components for the following structural components: Web and chord connection details and connector plate holding values for wood trusses; Web and chord connection details for steel joist and joist girders subjected to nonuniform loading; Bearing confinement steel, dapped end reinforcing, corbel reinforcing, bearing pads, and loose and embedded connection steel including welding and bolting requirements for precast concrete members; Member connection and bearing details for laminated wood members.

(b) *Energy conservation data.* Calculations and specifications shall be submitted in accordance with s. ILHR 63.01.

(c) *Heating and ventilating data.* A description of the construction for the walls, floors, ceilings and roof, and the transmission coefficients of the construction materials shall be furnished. The calculations shall include heat losses for the individual rooms (including transmission and infiltration and/or ventilation losses, whichever are greater) and a summary of the total building heat loss expressed in Btu/hour or watts.

Note: The department will accept as the basis for calculations and design data, the methods and standards recommended by the Mechanical Contractors' Association of America; the American Society of Heating, Refrigerating and Air Conditioning Engineers; and the Institute of Boiler and Radiator Manufacturers.

(d) *Additional data.* When requested, additional data pertaining to design, construction, materials and equipment shall be submitted to the department for approval.

(5) **APPLICATION FOR APPROVAL.** A plans approval application form shall be included with the plans submitted to the department for examination and approval. The department shall review and make a determination on an application for plan review within 15 business days of receipt of the application and all forms, fees, plans and documents required to complete the review.

Note: See Appendix A for an example of the plans approval application (form SB-118).

(a) *Conditional approval.* If, upon examination, the department determines that the plans and the application for approval substantially conform to the provisions of this code, a conditional approval, in writing, will be granted. All non-code-complying conditions stated in the conditional approval shall be corrected before or during construction. A conditional approval issued by the department shall not be construed as an assumption of any responsibility for the design or construction of the building.

(b) *Denial of approval.* If the department determines that the plans or the application do not substantially conform to the provisions of this code, the application for conditional approval will be denied, in writing.

Note: A letter will be sent to the designer and the owner of record with a statement relating to the examination of the plans and citing the conditions of approval or denial. The plans will be dated and stamped "conditionally approved" or "not approved," whichever applies. The department will retain one copy of the plans for all projects. The department will forward one copy of the plans for projects of less than 100,000 cubic feet and alterations of less than \$100,000 estimated cost to the state building inspector of record. The remaining plans will be returned to the person designated on the plans approval application.

History: Cr. Register, December, 1976, No. 252, eff. 1-1-77; am. (1) (g) 1, Register, December, 1977, No. 264, eff. 1-1-78; am. (4) (b), Register, May, 1978, No. 269, eff. 7-1-78; am. (1) (g) (intro.), Register, December, 1978, No. 276, eff. 1-1-79; am. (2) (e) 1., (3) (intro.) and (4) (b), cr. (2) (k), Register, January, 1980, No. 289, eff. 2-1-80; am. (1) (b) and (d), (2) (c) 2., (d) and (i), (3) (d), (4) (a), renum. (1) (e), (f) and (g) to be (1) (f), (g) and (i) and am. (1) (f) and (i) (intro.), cr. (1) (e) and (h), Register, December, 1981, No. 312, eff. 1-1-82; r. and recr. (1) (i), am. (4) (a) 2. intro., Register, December, 1983, No. 336, eff. 1-1-84; am. (5) (intro.), Register, January, 1985, No. 349, eff. 2-1-85; am. (1) (intro.) and (2) (intro.), Register, April, 1985, No. 352, eff. 5-1-85; am. (4) (a) L., Register, August, 1985, No. 356, eff. 1-1-86; r. (2) (k), Register, December, 1985, No. 360, eff. 1-1-86.

ILHR 50.125 Wisconsin insignia. A Wisconsin insignia shall be installed on a manufactured multi-family dwelling approved by the department and inspected at the manufacturing plant.

(1) **AFFIXING WISCONSIN INSIGNIA.** Each Wisconsin insignia shall be assigned and affixed to a specific manufactured multi-family dwelling in the manner approved by the department before it is shipped from the manufacturing plant. The serial number shall be located on the manufacturer's data plate.

(2) **MANUFACTURER'S RESPONSIBILITIES.** (a) *Insignia records.* The manufacturer shall keep permanent records regarding the handling of all Wisconsin insignias indicating the number of Wisconsin insignias which have been affixed to manufactured multi-family dwellings or manufactured building components (or groups of components); which Wisconsin insignias have been applied to which manufactured multi-family dwelling or building component; the disposition of any damaged or rejected Wisconsin insignias. The records shall be maintained by the manufacturer or by the independent inspection agency for at least 10 years. A copy of the records shall be sent to the department upon request.

(b) *Lost or damaged insignia.* 1. If Wisconsin insignias become lost or damaged, the department shall be notified immediately, in writing, by the manufacturer or dealer.

2. If Wisconsin insignias become damaged, the insignia shall be returned to the department with the appropriate fee to obtain a new insignia.

(3) **INSIGNIA SUSPENSION AND REVOCATION.** The department may suspend or revoke its approval if it determines that the standards for construction or the manufacture and installation of a manufactured multi-family dwelling do not meet this code or that such standards are not being enforced as required by this code.

(a) Upon suspension or revocation of the approval, no further insignias shall be attached to any manufactured multi-family dwelling with respect to which the approval was suspended or revoked.

(b) Upon suspension or revocation of the approval, all insignias allocated to the manufacturer shall be returned to the department no later than 30 days from the effective date.

History: Cr. Register, May, 1980, No. 293, eff. 6-1-80.

ILHR 50.13 Footing and foundation approval. Upon submission of the plans approval application form, at least 4 sets of footing and foundation plans, a plot plan, schematic floor plans locating exits, elevations, itemized structural loads, structural foundation calculations, and a fee, the department or its authorized representative, as provided in s. ILHR 50.21, may conditionally approve the footing and foundation plans to permit construction of the footings and foundations prior to the examination and approval of the complete plans. The department shall review and make a determination on an application for footing and foundation approval within 15 business days of receipt of the application and all forms, fees, plans and documents required to complete the review.

History: Cr. Register, December, 1976, No. 252, eff. 1-1-77; am. Register, May, 1980, No. 293, eff. 6-1-80; am. Register, January, 1985, No. 349, eff. 2-1-85; am. Register, April, 1985, No. 352, eff. 5-1-85.

ILHR 50.14 Permission to start construction. Upon submission of the plans approval application form, 4 complete sets of building plans and one copy of specifications, a written request by the owner to start construction, and a fee, the department or its authorized representative, as provided in s. ILHR 50.21, may issue a permission to start construction form for the footings and foundations. The holders of the permission form shall proceed at their own risk without assurance that a conditional approval for the building will be granted. The department shall review and make a determination on an application for permission to start construction within 3 business days of receipt of the application and all forms, fees, plans and documents required to complete the review.

Note 1: A permission to start construction form (form SB-198) is illustrated in the Appendix.

Note 2: Section 66.036, Stats., prohibits issuance of building permits by counties, cities, towns or villages for structures requiring connection to a private domestic sewerage treatment and disposal system unless the system satisfies all applicable requirements and all necessary permits for such system have been obtained.

History: Cr. Register, December, 1976, No. 252, eff. 1-1-77; am. Register, May, 1980, No. 293, eff. 6-1-80; am. Register, December, 1983, No. 336, eff. 1-1-84; am. Register, January, 1985, No. 349, eff. 2-1-85; am. Register, April, 1985, No. 352, eff. 5-1-85.

ILHR 50.15 Evidence of plan approval. The architect, engineer, designer, builder, manufacturer or owner shall keep at the building site one set of plans bearing the stamp of conditional approval and a copy of the specifications. The plans shall be open to inspection by an authorized representative of the department.

History: Cr. Register, December, 1976, No. 252, eff. 1-1-77; am. Register, May, 1980, No. 293, eff. 6-1-80.

ILHR 50.16 Revocation of approval. The department may revoke any approval, issued under the provisions of this code, for any false statements or misrepresentation of facts on which the approval was based.

History: Cr. Register, December, 1976, No. 252, eff. 1-1-77.

ILHR 50.17 Expiration of plan approval and extension of plan approval.
(1) **EXPIRATION OF PLAN APPROVAL.** Except as provided in sub. (2), plan Register, August, 1986, No. 368

approval by the department or its authorized representative shall expire 2 years after the date indicated on the approved plans if construction has not commenced within that 2 years or if, having once begun, construction ceases for a period of 2 years or more.

(2) **EXTENSION OF PLAN APPROVAL.** Upon request and payment of the fee under s. Ind 69.09 (7), plan approval shall be extended for one 2-year period provided that the approved plans are revised to comply with the code in effect at the time of the extension request and the request is submitted during the original approval period.

Note: According to s. 66.05 (1) (a), Stats., the local governmental body or building inspector may order the razing of buildings or structures, or portions thereof, where there has been a cessation of normal construction for more than 2 years.

History: Cr. Register, December, 1976, No. 252, eff. 1-1-77; r. and recr. Register, August, 1986, No. 368, eff. 9-1-86.

ILHR 50.175 Department limitation. A conditional approval of a plan by the department shall not be construed as an assumption of any design responsibility.

History: Cr. Register, August, 1986, No. 368, eff. 9-1-86.

ILHR 50.18* Inspections. (1) **ON-SITE.** Inspections shall be conducted by an authorized representative of the department to ascertain whether or not the construction or installations conform to the conditionally approved plans, the conditional approval letter, and the provisions of this code.

(2) **IN-PLANT.** Manufacturers of multi-family dwellings shall contract with the department or an independent inspection agency to conduct in-plant inspections to assure that the manufactured multi-family dwellings are in compliance with the plans approved by the department. All inspections shall be performed by a certified inspector or independent inspection agency.

Note: See Appendix A for an example of the inspection progress report (form SB-224B) and inspection report and orders (form SB-2).

History: Cr. Register, December, 1976, No. 252, eff. 1-1-77; am. Register, May, 1980, No. 293, eff. 6-1-80.

ILHR 50.19 Approval of materials, equipment and devices. All materials, equipment and devices not specifically mentioned in this code shall be permitted if approved in writing by the department. Sufficient data, tests and other evidence to prove that the material, equipment or device is equivalent to the standards required in this code shall be submitted. Upon receipt of a fee and a written request, the department may issue an approval number for the material, piece of equipment or device. The department shall review and make a determination on an application for material, equipment and device approval within 30 business days of receipt of all forms, fees, plans and documents required to complete the review.

History: Cr. Register, December, 1976, No. 252, eff. 1-1-77; am. Register, January, 1985, No. 349, eff. 2-1-85.

ILHR 50.20* Fees. Fees for petitions for variance, material approval, plan examination and approval, and for inspection of buildings, structures, and heating and ventilating shall be submitted as specified in s.

*See Appendix A for further explanatory material.

Ind 69.09. Fees shall be submitted at the time the application for approval is submitted. No plan examinations, approvals or inspections shall be made until the fees are received.

History: Cr. Register, December, 1976, No. 252, eff. 1-1-77; am. Register, August, 1985, No. 356, eff. 1-1-86.

Part V—First Class City and Certified Municipal Approvals

ILHR 50.21 Agent municipalities and counties. (1) **GENERAL.** This section shall establish the manner under which cities, villages, towns and counties may examine building plans and inspect buildings relative to s. 101.12 (3) (a), (b) and (g), Stats.

(2) **CONDITIONS OF PARTICIPATION.** Before assuming the responsibilities of examining building plans and providing inspection services cities, villages, towns and counties shall comply with all of the following conditions:

(a) Notify the department, in writing, at least 30 days prior to the date upon which the municipality or county intends to assume the responsibilities.

(b) Adopt by ordinance or regulation the responsibilities of plan examination and building inspection.

(c) Adopt by ordinance or regulation chs. ILHR 50 to 64 in its entirety.

(d) Submit to the department a certified copy of all ordinances or regulations assuming the plan examination and building inspection responsibilities and adopting chs. ILHR 50 to 64.

(e) Employ certified inspectors to perform the plan examination and building inspection functions.

(f) Forward to the department any information requested by the department relative to the examination of plans and the inspections of buildings.

(g) Notify the department, in writing, at least 30 days prior to the date upon which the municipality or county intends to relinquish the responsibilities.

(3) **JURISDICTION.** (a) *Departmental.* 1. Nothing in this section shall prevent the department from conducting its own investigations or inspections or issuing orders relative to the administration and enforcement of chs. ILHR 50 to 64.

2. The department shall administer and enforce chs. ILHR 50 to 64 in any municipality or county which has not assumed the responsibilities for plan examination and building inspections under sub. (2).

(b) *County.* 1. Ordinances enacted by a county under sub. (2) establishing county plan examination and building inspection functions shall apply to all municipalities within that county which have not assumed those functions pursuant to sub. (2).

2. Ordinances enacted by a county under sub. (2) establishing county plan examination and building inspection functions may not prevent or

prohibit any municipality within that county from assuming those functions pursuant to sub. (2) at any time.

(4) **CERTIFICATION OF INSPECTORS.** Inspectors employed by agent municipalities and counties to administer and enforce chs. ILHR 50 to 64 under sub. (2) shall be certified by the department in accordance with ch. ILHR 26 as certified commercial building inspectors.

(5) **PLAN EXAMINATION.** (a) *First class cities.* Drawings, specifications and calculations for all the types of buildings and structures specified in s. ILHR 50.12 (1), except state-owned buildings and structures, to be constructed within the limits of a first class city shall be submitted to that city, if that city has assumed the responsibilities of plan examination and building inspection in accordance with sub. (2).

(b) *Other municipalities and counties.* Drawings, specifications and calculations for all the types of buildings and structures specified in s. ILHR 50.12 (1), except state-owned buildings and structures, to be constructed within the municipal limits of a municipality other than a first class city or within a county shall be submitted to that municipality or county if the municipality or county has assumed the responsibilities of plan examination and building inspection in accordance with sub. (2) and if the plans are for:

1. New buildings or structures containing less than 50,000 cubic feet in total volume;
2. Additions to buildings or structures in which the volume of the addition results in the entire building or structure containing less than 50,000 cubic feet in total volume; or
3. Alterations to existing buildings or structures containing less than 100,000 cubic feet in total volume.

(c) *Plan submission procedures.* 1. A building permit application shall be included with the plan submitted to the municipality or county having jurisdiction for examination.

2. At least 2 sets of complete building plans and one copy of specifications shall be submitted to the municipality or county having jurisdiction for examination.

3. Building plans submitted to a municipality or county for examination shall include the information specified in s. ILHR 50.12 (3) and (4).

(d) *Plan approval.* 1. If the municipality or county having jurisdiction determines that the plans submitted substantially conform to the provisions of chs. ILHR 50 to 64 or other ordinances and regulations, an approval shall be issued as follows:

a. The plans shall be stamped "CONDITIONALLY APPROVED", signed and dated by a certified inspector.

b. One set of the conditionally approved plans shall be retained by the municipality or county and all other plans shall be returned to the submitter or their representative.

c. A notice of conditional approval shall be provided, in writing, to the submitter and the building owner stating all conditions of approval.

2. All non-code-complying and other conditions stated in the conditional approval notice shall be corrected or met before or during construction, and before occupancy of the building.

(e) *Denial of plan approval.* If the municipality or county determines that the plans submitted do not substantially conform to the provisions of chs. ILHR 50 to 64 or other legal ordinances and regulations, a denial for plan approval shall be issued as follows:

1. The plans shall be stamped "NOT APPROVED", signed and dated by a certified inspector.

2. One set of the not-approved plans shall be retained by the municipality or county and all other plans shall be returned to the submitter or their representative.

3. A notice of the not approved plans shall be provided in writing, to the submitter and the building owner stating the reasons for the denial.

(f) *Liability.* A conditional approval of a plan by a municipality or county may not be construed as an assumption of any responsibility on the part of the municipality, the certified inspector or the department for the design or construction of the building.

(6) **INSPECTION.** Inspections shall be conducted by an agent municipality or county to ascertain whether or not the construction or installation for buildings and structures conforms to the conditionally approved plans, the notice of conditional approval and chs. ILHR 50 to 64 as follows:

(a) All inspections, for the purpose of administration and enforcement of chs. ILHR 50 to 64, shall be performed by a certified inspector.

(b) A written report of each inspection shall be prepared. The report shall include the name of the certified inspector.

(c) A copy of each inspection report shall be furnished to the owner and plan submitter.

(d) A copy of each inspection report shall be permanently maintained in the municipal files or county files.

(e) The inspection report shall indicate all items of non-compliance noted during the inspection.

(f) If non-complying items are not corrected, orders to correct shall be issued in accordance with local ordinances.

(7) **FEES.** Municipalities and counties having jurisdiction of plan examination and building inspections may set by ordinance the fees for plan examination and building inspection services.

Note: See Appendix A for a list of the municipalities and counties providing plan examination and building inspections under this section.

History: Cr. Register, December, 1976, No. 252, eff. 1-1-77; r. and recr. Register, April, 1985, No. 352, eff. 5-1-85.

Part VI—Enforcement, Petition for Variance, Appeals, and Penalties

ILHR 50.23 Enforcement. The provisions of this code shall be enforced by the department, or by municipal officials or other local officials who are required by law to enforce the administrative rules of the department.

History: Cr. Register, December, 1976, No. 252, eff. 1-1-77.

ILHR 50.24 Appeals. Any person affected by any local order which is in conflict with a rule of the department may petition the department for a hearing on the grounds that the local order is unreasonable and in conflict with the rule of the department. The department shall review and make Register, August, 1985, No. 356

a determination on an appeal of a local ordinance within 60 business days of receipt of a verified petition submitted with all forms, fees, plans and documents required to complete the review.

Note: Section 101.01 (1) (g), Stats., defines "local order" as any ordinance, order, rule or determination of any common council, board of aldermen, board of trustees or the village board, of any village or city, or the board of health of any municipality, or an order or direction of any official of such municipality, upon any matter over which the department has jurisdiction.

History: Cr. Register, December, 1976, No. 252, eff. 1-1-77; am. Register, January, 1985, No. 349, eff. 2-1-85. **FP**

ILHR 50.25* Petition for variance. (1) **PROCEDURE.** The department shall consider and may grant a variance to an administrative rule upon receipt of a fee, a completed petition for variance form from the owner, and a position statement from the fire department having responsibility and an interest in the rule, provided an equivalency is established in the petition for variance which meets the intent of the rule being petitioned. The department may impose specific conditions in a petition for variance to promote the protection of the health, safety or welfare of the employes or the public. Violation of those conditions under which the petition is granted constitutes a violation of these rules.

(2) **PETITION PROCESSING TIME.** Except for priority petitions, the department shall review and make a determination on a petition for variance within 30 business days of receipt of all calculations, documents and fees required to complete the review. The department shall process priority petitions within 10 business days.

Note 1: See Appendix A for an example of the petition for variance (form SB-8) and the fire department position statement (form SB-8A).

Note 2: Section 101.02 (6), Stats., outlines the procedure for submitting petitions to the department and the department procedures for hearing petitions.

History: Cr. Register, December, 1976, No. 252, eff. 1-1-77; am. Register, December, 1978, No. 276, eff. 1-1-79; am. Register, May, 1980, No. 293, eff. 6-1-80; am. Register, October, 1984, No. 346, eff. 11-1-84; cr. (2), Register, January, 1985, No. 349, eff. 2-1-85.

ILHR 50.26 Penalties. Penalties for violations shall be assessed in accordance with s. 101.02, Stats.

Note 1: Section 101.02 (13) (a), Stats., indicates penalties will be assessed against any employer, employe, owner or other person who fails or refuses to perform any duty lawfully enjoined, within the time prescribed by the department, for which no penalty has been specifically provided, or who fails, neglects or refuses to comply with any lawful order made by the department, or any judgment or decree made by any court in connection with ss. 101.01 to 101.25. For each such violation, failure or refusal, such employe, owner or other person must forfeit and pay into the state treasury a sum not less than \$10 nor more than \$100 for each violation.

Note 2: Section 101.02 (12), Stats., indicates that every day during which any person, persons, corporation or any officer, agent or employe thereof, fails to observe and comply with an order of the department will constitute a separate and distinct violation of such order.

History: Cr. Register, December, 1976, No. 252, eff. 1-1-77.

*See Appendix A for further explanatory material.



Chapter ILHR 51

DEFINITIONS AND STANDARDS

ILHR 51.01	Definitions (p. 19)	ILHR 51.14	Safety glazing (p. 73)
ILHR 51.015	Scope (p. 35)	ILHR 51.15	Standard exit (p. 75)
ILHR 51.02	General requirements (p. 35)	ILHR 51.161	Exit distribution (p. 77)
ILHR 51.03	Classes of construction standards (p. 41)	ILHR 51.16	Stairways and ramps (p. 77)
ILHR 51.04	Scope (p. 49)	ILHR 51.161	Handrails (p. 79)
ILHR 51.042	General requirements (p. 49)	ILHR 51.162	Guardrails (p. 80)
ILHR 51.043	Approved rating methods (p. 50)	ILHR 51.164	Headroom (p. 81)
ILHR 51.044	Approved testing laboratories (p. 50)	ILHR 51.165	Stairway identification (p. 81)
ILHR 51.045	Typical examples of fire-resistant structural components (p. 51)	ILHR 51.166	Basement stairways (p. 81)
ILHR 51.046	Calculation method (p. 55)	ILHR 51.167	Exit access (p. 82)
ILHR 51.047	Fire-rated door assemblies in fire-rated construction (p. 55)	ILHR 51.17	Smokeproof stair tower (p. 82)
ILHR 51.048	Fire window and glass block assemblies in fire-rated construction (p. 56)	ILHR 51.18	Interior enclosed stairway (p. 82)
ILHR 51.049	Miscellaneous openings in fire-rated construction (p. 57)	ILHR 51.19	Horizontal exit (p. 83)
ILHR 51.05	Roof coverings (p. 58)	ILHR 51.20	Fire escapes (p. 84)
ILHR 51.06	Foam plastics (p. 58)	ILHR 51.21	Standpipe and hose systems (p. 87)
ILHR 51.065	Light-transmitting plastics (p. 62)	ILHR 51.22	Fire extinguishers (p. 90)
ILHR 51.07	Interior finishes (p. 69)	ILHR 51.23	Automatic sprinklers (p. 91)
ILHR 51.08	Occupancy separations (p. 72)	ILHR 51.24	Fire alarm systems (p. 92)
		ILHR 51.245	Smoke detectors (p. 94)
		ILHR 51.25	Adoption of ASTM standards (p. 94)
		ILHR 51.26	Adoption of ACI standards (p. 98)
		ILHR 51.27	Adoption of miscellaneous standards (p. 98)

Note: Chapter Ind 51 was renumbered to be chapter ILHR 51 effective January 1, 1984.

Note: The definitions of words and phrases not defined in this section should be taken from the current edition of Webster's New International Dictionary.

ILHR 51.01 Definitions. (1) "Accessory room" means any room or enclosed floor space used for eating, cooking, bathrooms, water closet compartments, laundries, pantries, foyers, hallways and other similar floor spaces. Rooms designated as recreation, study, den, family room, office and other similar floor spaces, in addition to habitable rooms, are not considered accessory rooms.

(1a) **AIR CONDITIONING.** The process of treating air to control simultaneously its temperature, humidity, cleanliness and distribution to meet the requirements of the conditioned space.

(2) **ALLEY.** Any legally established public thoroughfare less than 30 feet in width but not less than 10 feet in width whether designated by name or number.

(3) **APPROVED.** Approval granted by the department under the regulations stated in this code.

(3a) "Approved diversified tests" means fire tests which evaluate materials or construction assemblies representative of actual end use applications.

Note: Approved diversified tests may include, but are not limited to, ASTM E84 — Test for Surface Burning Characteristics of Building Materials, ASTM E119 — Fire Tests of Building

Construction and Materials, ASTM D1929 — Standard Test Method for the Ignition Properties of Plastics, FM 4880 — Factory Mutual Building Corner Fire Test, PICC 401 — Enclosed Room Corner Test and UL 1040 — Outline of Investigation of Insulated Wall Construction.

(4) **AREA (GROSS)**. The maximum horizontal projected area within the perimeter of the outside surface of walls or supports of the building or structure. Exterior cantilever open balconies are not included.

(5) **AREA (NET)**. The occupied or usable floor area in a building but not including space occupied by columns, walls, partitions, mechanical shafts or ducts.

(5a) **AREAWAY**. Exterior area whose grade is below the grade (at building) and having at least one side consisting of the exterior wall of a building.

(5b) **"ATRIUM"** means a floor opening or series of floor openings connecting 2 or more stories that is covered at the top of the series of openings and is used for purposes other than an enclosed stairway; elevator hoistway; or utility shaft used for plumbing, electrical, air conditioning or communication facilities.

(6) **ATTIC**. The space not used for human occupancy located between the ceiling of uppermost story and the roof.

(7) **AUTOMATIC**. Automatic as applied to a fire protective device, is one which functions without human intervention and is actuated as a result of the predetermined temperature rise, rate of rise of temperature, combustion products or smoke density such as an automatic sprinkler system, automatic fire door, automatic fire shutter, or automatic fire vent.

(7a) **"Automatic fire sprinkler system"**, for fire protection purposes, means an integrated system of underground and overhead piping designed in accordance with fire protection engineering standards. The system includes a suitable water supply, such as a gravity tank, fire pump, reservoir or pressure tank or connection beginning at the supply side of an approved gate valve located at or near the property line where the pipe or piping system provides water used exclusively for fire protection and related appurtenances and to standpipes connected to automatic sprinkler systems. The portion of the sprinkler system above ground is a network of specially sized or hydraulically designed piping installed in a building, structure or area, generally overhead, and to which sprinklers are connected in a systematic pattern. The system includes a controlling valve and a device for actuating an alarm when the system is in operation. The system is usually activated by heat from a fire and discharges water over the fire area.

(7b) **"Automatic fire suppression system"** means a mechanical system designed and equipped to detect a fire, actuate an alarm and suppress or control a fire using water, water spray, foam, carbon dioxide, halogenated agent or other approved suppression agent.

(8) **BALCONY (EXTERIOR)**. An elevated platform attached to a building and enclosed on one or more sides by railings.

(9) **BALCONY (INTERIOR)**. An open intermediate level or stepped floor. Also see "Stories, Number of."

(10) **BASEMENT.** A basement floor is that level below the first or ground floor level with its entire floor below exit discharge grade.

(11) **BEARING WALL.** See "Wall (bearing)."

(11a) "Bed and breakfast establishment", as defined in s. 50.50 (1), Stats., means any place of lodging that provides 4 or fewer rooms for rent, is the owner's personal residence and is occupied by the owner at the time of rental.

(12) **BUILDING.*** A structure for support, shelter or enclosure of persons or property.

(13) "Building or structure" means public building or place of employment.

(14) **BUTTRESS.** A structural projection which is an integral part of a wall, primarily to provide resistance to lateral forces.

(15) **CAVITY WALL.** See "Wall (cavity)."

(16) **CEILING PROTECTION.** The fire protection membrane suspended beneath the floor or ceiling construction which, when included with the construction, develops the fire-resistive rating for the overall assembly.

(16a) **CERTIFIED INSPECTOR.** Certified inspector means an individual certified by the department to administer and enforce this code.

(17) **CLOSING DEVICE (FIRE DOOR).** A closing device is one which will close the door and be adequate to latch or hold, or both, hinged or sliding door in a closed position.

(a) *Automatic.* An automatic closing device is one which functions without human intervention and is actuated as a result of the predetermined temperature rise, rate of rise of temperature, combustion products or smoke density.

(b) *Self-closing.* A self-closing device is one which will maintain the door in a closed position.

(18) **COMBUSTIBLE CONSTRUCTION.** An assembly such as a wall, floor or roof having components of combustible material.

(19) **COMBUSTIBLE MATERIAL.** All materials not classified as "noncombustible" are considered combustible. This property of a material does not relate to its ability to structurally perform under fire exposure. The degree of combustibility is not defined by standard fire test procedures.

(19a) "Commercial motor vehicle" means all motor vehicles other than passenger vehicles for not more than 9 passengers.

(19b) "Community-based residential facility" means any place where 3 or more unrelated adults reside in which care, treatment or services above the level of room and board but not including nursing care are provided to persons residing in the facility as a primary function of the facility. "Community-based facility" does not include a nursing home, except that the department of health and social services may designate a category or categories of intermediate care facilities which serve fewer than 20 residents and which otherwise meet the definition of this subsec-

*See Appendix A for further explanatory material.

tion to be licensed and regulated as community-based residential facilities. The reception and care or treatment of a person in a convent or facility owned or operated exclusively by and for members of a religious order shall not constitute the premises to be a "community-based residential facility."

(20) **CONCRETE.** See "Types of Concrete," s. ILHR 51.045 (1) (a).

(21) **CONSTRUCTION.** Includes all labor and materials used in the framing or assembling of component parts in the erection, installation, enlargement, alteration, repair, moving, conversion, razing, demolition or removal of any appliance, device, building, structure or equipment.

(22) **CORRIDOR.** An enclosed passageway in a building for public ingress and egress to and from dwelling units, rooms or other areas and leading to a lobby, foyer or exit discharge.

(22a) **CORRIDOR (REQUIRED EXIT).** A fire-rated enclosure beginning at the end point of maximum allowable exit distance and continuing to the exit discharge door.

Note: See line 20 of Table 51.03-A.

(23) **COURT.** A court is an open, exterior space providing required natural light or ventilation for the building or providing a pathway for public egress from a building exit to a public thoroughfare.

(24) **COURT (INNER).** An inner court is a court surrounded on all sides by walls.

(25) **COURT (INNER LOT LINE).** An inner lot line court is a court bounded on 3 sides by walls and on the remaining side by a lot line or property line.

(26) **COURT (OUTER).** An outer court is a court bounded on 3 sides with walls and on the remaining side by a street, alley or other open space not less than 15 feet wide.

(27) **COURT (OUTER LOT LINE).** A court with one side on a lot line or property line and opening to a street or open space not less than 15 feet wide.

(28) **CURTAIN WALL.** See "Wall (curtain)."

(29) **DEPARTMENT.** Means the department of industry, labor and human relations.

(29a) "Direct vent sealed combustion chamber appliance" means a gas-fired heating appliance which is constructed and installed so that all air for combustion is brought directly from the outside atmosphere to inside the combustion chamber and all flue gases are discharged directly to the outside atmosphere and that is capable of operating only when the integrity of the sealed combustion chamber is maintained.

(30) **DIVISION WALL.** See "Wall (division)."

(31) **DUCT.** Any pipe, flue, or tunnel used to convey air, gases and entrained materials. An underground duct is any part of a duct that is below the surface of the ground.

(32) **DUCT FURNACE.** See "Furnace (duct)."

(33) **ELEVATOR.** See ch. Ind 4.

(34) **EQUIPMENT.** Self-contained systems and apparatus attached to or built into the building and used for mechanical or electrical processing, comfort, safety, sanitation, communication or transportation within a building.

(35) **EXHAUST VENTILATING SYSTEM.** See "Ventilating System (exhaust)."

(36) **EXISTING.** A building, structure, or equipment completed or in the course of construction or use or occupied prior to the effective date of applicable rules of this code.

(36a) "Exit" means that portion of a means of egress which is separated from all other spaces of the building or structure by construction providing a protected way of travel to the exit discharge.

(36b) "Exit access" means that portion of a means of egress which leads to an entrance to an exit.

(36c) "Exit access door" means any door that leads to the exit access.

(37) **EXIT COURT.** See "Court (exit)."

(37a) "Exit discharge" means that portion of a means of egress between the termination of an exit and a street, alley, court or a public way.

(38) **EXIT DISCHARGE GRADE.** See "Grade (exit discharge)."

(38a) "Exit door" means a door that leads from that portion of a means of egress known as the exit access to the outside of a building or to a required exit, such as a stairway, smokeproof tower, ramp or horizontal exit.

(38b) "Exit passageway" means a horizontal means of exit travel that is protected from a fire in a manner similar to an enclosed interior exit stair.

(39) **EXIT (VERTICAL).** See "Vertical Exit."

(40) **EXTERIOR BALCONY.** See "Balcony (exterior)."

(41) **EXTERIOR WALL.** See "Wall (exterior)."

(41a) **FACTORY.** A factory is any premises wherein labor is used in manufacturing, making or altering or adapting articles for the purpose of trade or gain.

(42) **FAMILY.*** Means 2 or more individuals who are related to each other by blood, marriage, adoption or legal guardianship. For purposes of this code a group of not more than 4 persons not necessarily related by blood or marriage, living together in a single living unit will be considered equivalent to a single family.

(42a) **FARM OPERATION.** The farm operation is the planting and cultivating of the soil and growing of farm products substantially all of which have been planted or produced on the farm premises.

Note: The farm operation, according to s. 102.04 (3), Stats., includes: the management, conserving, improving and maintaining of the premises, tools, equipment, improvements and the

*See Appendix A for further explanatory material.

exchange of labor or services with other farmers; the processing, drying, packing, packaging, freezing, grading, storing, delivery to storage, carrying to market or to a carrier for transportation to market and distributing directly to the consumer; the clearing of such premises and the salvaging of timber and the management and use of wood lots thereon but does not include logging, lumbering and wood-cutting operations unless the operations are conducted as an accessory to other farm operations.

(42b) **FARM PREMISES.** The farm premises is defined to be the area which is planted and cultivated. The farm premises does not include greenhouses, structures or other areas unless used principally for the production of food or farm products.

(42c) **FARM PRODUCTS.** Farm products are defined as agricultural, horticultural and arboricultural crops. Animals considered within the definition of agricultural include livestock, bees, poultry, fur-bearing animals, and wildlife or aquatic life.

(42d) **FARMING.** Farming means the operation of a farm premises owned or rented by the operator.

(43) **FIRE DOOR.** A door so constructed as to give protection against the passage of fire.

(44) **FIRE DOOR ASSEMBLY.** The assembly of fire door and its accessories, including all hardware, frames, closing devices and their anchors, so constructed as to give protection against the passage of fire.

(45) **FIRE DOOR CLOSING DEVICE.** See "Closing Device (fire door)."

(46) **FIRE RESISTANCE AND FIRE-RESISTIVE MATERIAL.** Having the property to withstand fire or give protection from it. As applied to elements of building, it is characterized by the ability to confine a fire or to continue to perform a given structural function, or both.

(47) **FIRE-RESISTIVE CLASSIFICATION.** Fire-resistive classification is the time in hours during which a material or assembly continues to exhibit fire resistance under conditions of tests and performance as specified in ASTM E-119, ASTM E-152 and ASTM E-163.

(48) **FIRE-RESISTIVE PROTECTION.** An insulating material applied directly, attached to, or suspended from a structural assembly, to maintain the structural integrity of a member or system for the specified time rating.

(49) **FIRE-RESISTIVE PROTECTION, DIRECTLY APPLIED.** A coating material applied directly to the structural element for the purpose of fire protection.

(50) **FIRE-RESISTIVE RATING.** Refer to fire-resistive classification.

(51) **FIRE-RETARDANT ROOF COVERINGS.** Roof coverings shall be classified on the basis of protection provided against fire originating outside the building or structure on which they have been installed.

(a) Class A roof coverings are those which are effective against severe fire exposures (meeting the 3 methods for fire tests of class A roof coverings [ASTM Standard E-108]) and possess no flying brand hazard.

(b) Class B roof coverings are those which are effective against moderate fire exposures (meeting the 3 methods for fire tests of class B roof coverings [ASTM Standard E-108]) and possess no flying brand hazard.

(c) Class C roof coverings are those which are effective against light fire exposures (meeting the 3 methods for fire tests of class C roof coverings [ASTM Standard E-108]) and possess no flying brand hazard.

(52) **FIRE RETARDANT—TREATED WOOD.** Fire-retardant wood includes lumber or plywood that has been treated with a fire-retardant chemical to provide classifications (flame-spread [FSC] and fuel contributed [FCC]) of 25 or less by ASTM method E-84, shows no progressive combustion during 30 minutes of fire exposure by this method, and is so labeled. Fire-retardant wood for decorative and interior finish purposes provides reduced flame-spread classification (FSC) by ASTM method E-84 as specified by the code for materials used in the particular applications.

(53) **FIRE WINDOW ASSEMBLY.** A fire window includes glass, frame, hardware and anchors constructed and glazed to give protection against the passage of flame.

(54) **FIRST FLOOR.** The first floor is the primary floor used in determining the number of stories of a building.

(55) **FLAME-SPREAD CLASSIFICATION.** Flame-spread classification (FSC) is a comparative rating of the measure of flame-spread on a surface of a material or assembly as determined under conditions of tests and performance as specified in ASTM E-84.

(56) **FLAME-SPREAD RATING.** Refer to flame-spread classification.

(56a) **FLOOR.** The bottom or lower part of an enclosed space including any portions raised or depressed by not more than 3 feet from the designated principal level where the raised or depressed portion is treated architecturally as a part of the same principal level.

(57) **FLOOR AREA.** See "Area (net)."

(57a) **FLOOR LEVEL.** The upper surface of a floor treated architecturally as the designated principal floor at a given elevation.

(57b) "Foam plastic" means a manufactured organic material used as a building material, insulation or sound-absorbing material.

(58) **FOYER.** An enclosed space and passageway into which aisles, corridors, stairways, or elevators may exit and from which the public has access to exits.

(58a) "Freestanding freezer and cooler" means equipment with an aggregate floor area of less than 400 square feet used to provide a controlled environment at 50°F. or less for storing, displaying or merchandising of products. The freezers and coolers are installed in a building or structure for weather protection and do not rely upon the building or structure for lateral or vertical support, except for the floor load.

Note: Freezers and coolers which do not meet this definition are considered refrigerated facilities. See s. ILHR 51.06 (7) (a) for additional requirements.

(58b) "Freezer warehouse" means a building or structure designed and operated at a temperature of 32°F. or below and adapted to the reception and storage of goods, products and merchandise.

(59) **FRONT YARD.** See "Yard (front)."

(60) **FUEL CONTRIBUTED CLASSIFICATION.** Fuel contributed classification (FCC) is a comparative measure of the fuel contribution of a material or an assembly in the flame-spread test per ASTM E-84.

(61) **FURNACE.** A completely self-contained direct-fired, automatically controlled, vented appliance for heating air by transfer of heat of combustion through metal to the air and designed to supply heated air through ducts to spaces remote from the appliance location.

(62) **FURNACE (DUCT).** A suspended direct-fired heating appliance normally installed in air ducts. Air circulation is provided by a blower not furnished as part of the appliance.

(63) **GRADE (AT BUILDING).** Elevation of surface of paved or unpaved ground adjacent to wall of a building.

(64) **GRADE (EXIT DISCHARGE).** The elevation of finished exterior surface of paved or unpaved ground at any exit discharge doorsill.

(65) **GRAVITY EXHAUST VENTILATION.** See "Ventilation (gravity exhaust)."

(66) **GROSS AREA.** See "Area (gross)."

(67) **GROUND FLOOR.** A ground floor is that level of a building on a sloping or multilevel site which has its floor line at or not more than 3 feet above exit discharge grade for at least one-half of the required exit discharges.

(67a) **HABITABLE ROOM.*** Any room or enclosed floor space arranged for living and/or sleeping purposes.

(68) **HAZARDOUS PIPING.** See "Piping (hazardous)."

(68a) "Health care facility" means both hospital or nursing home.

(69) **HEATING SYSTEM.** Any combination of building construction, machinery, devices or equipment, so proportioned, arranged, installed, operated, and maintained as to produce and deliver in place the required amount and character of heating service.

(70) **HEIGHT (BUILDING).** Height of a building is measured from the average of the exit discharge grade elevation of all required first story exits to the top of a level roof or to a point $\frac{1}{2}$ of the distance between the intersection of the exterior wall surface (extended) with the roof surface, and the highest part of the roof but not to include penthouses.

Note: For exceptions to penthouses see definition "Stories, Number of."

(71) **HOLLOW BONDED WALL.** See "Wall (hollow bonded)."

(71a) "Hospital" means any building, structure, institution or place used for the maintenance and operation of facilities for the diagnosis, treatment of and medical or surgical care for 3 or more nonrelated individuals hereinafter designated patients, suffering from illness, disease, injury or disability, whether physical or mental, and including pregnancy and regularly making available at least clinical laboratory services, and diagnostic x-ray services and treatment facilities for surgery, or obstetrical care, or other definitive medical treatment.

*See Appendix A for further explanatory material.

(71b) "Housing for the elderly" means a residential occupancy building the construction of which is financed by state or federal agencies with occupancy limited to elderly people meeting specific age criteria as specified by the financing agency.

(71c) INDEPENDENT INSPECTION AGENCY. Independent inspection agency means any person, firm, association, partnership or corporation, other than a municipal corporation, certified by the department to perform certified inspections under this code.

(72) INNER COURT. See "Court (inner)."

(73) INNER LOT LINE COURT. See "Court (inner lot line)."

(74) INTAKE (OUTSIDE AIR). See "Outside Air Intake."

(75) INTERIOR BALCONY. See "Balcony (interior)."

(75a) "Interior finish" means the exposed interior surfaces of buildings, including, but not limited to fixed or movable walls and partitions, columns, ceilings, and floors.

(a) "Class A interior finish" includes any material classified at 25 or less on the flame spread test scale and 450 or less on the smoke test scale in accordance with ASTM E84 — Test of Surface Burning Characteristics of Building Materials.

(b) "Class B interior finish" includes any material classified at more than 25 but not more than 75 on the flame spread test scale and 450 or less on the smoke test scale in accordance with ASTM E84 — Test of Surface Burning Characteristics of Building Materials.

(c) "Class C interior finish" includes any material classified at more than 75 but not more than 200 on the flame spread test scale and 450 or less on the smoke test scale in accordance with ASTM E84 — Test of Surface Burning Characteristics of Building Materials.

(d) "Class I interior floor finish" includes any material with a minimum critical radiant flux of 0.45 watts per square centimeter as determined in accordance with ASTM E648 — Test for Critical Radiant Flux of Floor Covering Systems Using a Radiant Heat Energy Source.

(e) "Class II interior floor finish" includes and material with a minimum critical radiant flux of 0.22 watts per square centimeter as determined in accordance with ASTM E648 — Standard Method of Test for Critical Radiant Flux of Floor Covering Systems Using a Radiant Heat Energy Source.

(76) JACKETED STOVE. See "Stove (jacketed)."

(76a) LIVING UNIT. Any enclosed floor space consisting of one or more habitable rooms (with or without accessory rooms) used by a person or family.

(77) LOBBY. An enclosed space into which aisles, corridors, stairways, elevators or foyer exit and provides access to exits.

(78) LOT LINE. A legally established line dividing one lot, plot of land or parcel of land from an adjoining lot or plot of land or parcel of land.

(79) **MAJOR APPARATUS.** Central air-handling equipment supplying more than one occupancy or rooms and heat-producing equipment generating heat for the heating and ventilating system.

(79a) **MANUFACTURED MULTI-FAMILY DWELLING.** Manufactured multi-family dwelling means any structure or component which is intended for use as a multi-family dwelling and for which certification is sought by the manufacturer, and which is of open or closed construction, fabricated or assembled on-site or off-site in manufacturing facilities for installation, or assembly and installation at the building site. For purpose of this code, a manufactured multi-family dwelling means 3 or more living units attached together, or 2 or more living units and a business occupancy attached together.

(80) **MASONRY.** A construction composed of separate units such as brick, block, hollow tile, stone or approved similar units or a combination thereof, laid up or built unit by unit and bonded by approved manner.

(80a) "Means of egress" means a continuous and unobstructed way of exit travel from any point in a building or structure to a street, alley, court or a public way. A means of egress consists of the exit access, the exit and the exit discharge. A means of egress includes the vertical and horizontal ways of travel and includes intervening room space, doorways, hallways, corridors, passageways, balconies, ramps, stairs, enclosures, lobbies, horizontal exits and courts.

(81) **MECHANICAL VENTILATION.** See "Ventilation (mechanical)."

(82) **MEZZANINE OR MEZZANINE FLOOR.** An intermediate floor, either open or enclosed. Also see "Stories, Number of."

(82a) "Mini-warehouse" means an unoccupied compartmentalized warehouse building having one or more overhead doors serving each compartment.

(83) **NET AREA.** See "Area (net)."

(84) **NONBEARING WALL.** Refer to "Wall (exterior)" or "Partition."

(85) **NONCOMBUSTIBLE CONSTRUCTION.** An assembly such as a wall, floor or roof having components of noncombustible material.

(86) **NONCOMBUSTIBLE MATERIAL.** A noncombustible material is one which, in the form in which it is used, meets one of the requirements par. (a) or (b) listed below. Materials used adjacent to or in contact with heat-producing appliances, warm air ducts, plenums and chimneys shall be classified as noncombustible only on the basis of requirement par. (a). Noncombustible does not apply to the flame-spread characteristics of interior finish or trim materials. No material shall be classed as noncombustible building construction material which is subject to increase in combustibility or flame-spread classification (FSC) beyond the limits herein established through the effects of age, moisture or other atmospheric conditions.

Note: The federal trade commission does not consider ASTM E-84 as an accurate indicator of the performance of cellular plastics used in building construction under actual fire conditions, and that it is only valid as a measurement of the performance of such materials under specific, controlled test conditions. The 25 flame-spread rating is not intended to reflect hazards presented by such products under actual fire conditions. The federal trade commission considers that under actual fire conditions, such products, if allowed to remain exposed or

unprotected, will under some circumstances produce rapid flame spread, quick flashover, toxic or flammable gases, dense smoke and intense and immediate heat and may present a serious fire hazard.

(a) Materials which pass the test procedure of ASTM E-136 for defining noncombustibility of elementary materials when exposed to a furnace temperature of 1,382° F. for a minimum period of 5 minutes, and do not cause a temperature rise of the surface or interior thermocouples in excess of 54° F. above the furnace air temperature at the beginning of the test and which do not flame after an exposure of 30 seconds.

(b) Materials having a structural base of noncombustible material as defined in par. (a), with a surfacing not more than 1/8 inch thick which has a flame-spread classification (FSC) not greater than 50 when tested in accordance with the method of test for surface burning characteristics of building materials (ASTM E-84).

(86a) "Nursing home" means any building, structure, institution or place which provides 24-hour services including board and room to 3 or more unrelated residents who because of their mental or physical condition require nursing care or personal care in excess of 7 hours a week. The term "nursing home" wherever used in chs. ILHR 50-64, includes nursing and convalescent homes, skilled nursing facilities, infirmaries in homes for the aged, and intermediate care facilities of 15 beds or more.

(87) OCCUPANCY OR USE. The purpose for which a building, structure, equipment, materials, or premises, or part thereof, is used or intended to be used as regulated in this code.

(88) OCCUPIED. Refers to any room or enclosure used by one or more persons for other than incidental maintenance.

(89) OPEN SPACES. Front (setback), rear and side yards, exit courts, outer courts, and outer lot line courts on the same property with a building as regulated by this code.

(90) OUTDOOR OPENINGS. May be doors, windows or skylights located in outside walls or roof and can be opened to provide natural ventilation to the occupied space.

(91) OUTER COURT. See "Court (outer)."

(92) OUTER LOT LINE COURT. See "Court (outer lot line)."

(93) OUTLET (SUPPLY OPENING). An opening, the sole purpose of which is to deliver air into any space to provide heating, ventilating or air conditioning.

(93a) "Outpatient surgical facility" means a facility devoted to the performance of surgical procedures utilizing inhalation anesthetics without anticipation of the overnight stay of patients.

(94) OUTSIDE AIR. Air that is taken from outside the building and is free from contamination of any kind in proportions detrimental to the health or comfort of the persons exposed to it.

(95) OUTSIDE AIR INTAKE. Includes the ducts and outdoor openings through which outside air is admitted to a ventilating, air conditioning or heating system.

(96) PANEL WALL. See "Wall (panel)."

(97) **PARTITION.** A partition is an interior nonbearing vertical element serving to enclose or divide an area, room or space. Portable or demountable partitions requiring tools for installation or removal are considered partitions not furniture.

(98) **PARTY WALL.** See "Wall (party)."

(99) "Penthouse" means an enclosed or partially enclosed structure extending above the main roof of a building or structure and enclosing a stairway, tank, elevator, machinery, mechanical equipment or other apparatus and not used for human occupancy.

(100) **PIER.** An isolated column of masonry or concrete. A section of bearing wall not bonded on the sides into adjoining masonry shall be considered to be a pier when its horizontal dimension measured at right angles to the thickness does not exceed 4 times the thickness.

(101) **PILASTER.** A projection of masonry for the purpose of bearing concentrated loads, or to compensate for reduction of wall section by chases, openings or recesses, or for the purpose of stiffening the wall against lateral forces. (See also "Buttress.")

(102) **PIPING (HAZARDOUS).** Any service piping conveying oxygen, flammable liquids, flammable gases or toxic gases.

(102a) "Place of abode" means a residential building or part of a residential building used as follows:

(a) Occupied as a residence of 3 or more families living independently or occupied by 2 such families and used also for business purposes; or

(b) Occupied for sleeping of lodging purposes by 3 or more persons not members of the same family.

Note: Examples of places of abode include but are not limited to apartment buildings, garden apartments, row houses, town houses, condominiums, hotels, motels, rooming houses, dormitories, convents, monasteries, homes for the aged and certain community-based residential facilities.

(102b) **PLACE OF EMPLOYMENT.** The term "place of employment" includes every place, whether indoors or out or underground and the premises appurtenant thereto where either temporarily or permanently any industry, trade or business is carried on, or where any process or operation, directly or indirectly related to any industry, trade or business, is carried on, and where any person is, directly or indirectly, employed by another for direct or indirect gain or profit, but does not include any place where persons are employed in a) private domestic service which does not involve the use of mechanical power or b) farming.

(103) **PORCH.** An unenclosed exterior structure at or near grade attached or adjacent to the exterior wall or any building, and having a roof and floor. (See also "Terrace" and "Balcony.")

(104) "Property line" means the following:

(a) A legally established line dividing one lot, plot of land or parcel of land from an adjoining lot or plot of land or parcel of land; or

(b) A permanent, recorded easement, on file with the department, on adjoining property providing control over the property eased.

(104a) **PUBLIC BUILDING.** The term "public building" means and includes any structure, including exterior parts of such building, such as a porch, exterior platform or steps providing means of ingress or egress, used in whole or in part as a place of resort, assemblage, lodging, trade, traffic, occupancy, or use by the public or by 3 or more tenants.

(105) **PUBLIC THOROUGHFARE.** Any legally established street or alley as defined herein.

(105a) **REMODELING.** To remodel or alter, or both, means to change any building or structure which affects the structural strength, fire hazard, internal circulation, or exits of the existing building or structure. This definition does not apply to maintenance, reroofing, or alterations to the heating and ventilating or electrical systems.

(106) **REQUIRED.** A term for mandatory use under the provisions of this code.

(106a) **REQUIRED EXIT CORRIDOR.** See "Corridor (Required Exit)."

(107) **RESTRAINED SUPPORT.** A flexural member where the supports or the adjacent construction, or both, provides complete or partial restraint against rotation of the ends of the member or partial restraint against horizontal displacement, or both, when subject to a gravity load or temperature change, or both.

(108) **RETAINING WALL.** See "Wall (retaining)."

(109) **RETURN (OR EXHAUST OPENING).** Any opening, the sole purpose of which is to remove air from any space being heated, ventilated or air conditioned.

(110) **ROADWAY.** That portion of a public thoroughfare devoted to vehicular traffic, or that part included between curbs.

(111) **ROOF.** The structural cover of a building with a slope range bearing from horizontal to a maximum of 60° to the horizontal.

(112) **ROOF COVERING.** Refers to the covering applied over the roof construction for the purpose of weather or fire resistance.

(113) **ROOF COVERINGS (FIRE-RETARDANT).** See "Fire-Retardant Roof Coverings."

(114) **ROOM.** A space within a building completely enclosed with walls, partitions, floor and ceiling, except for openings for light, ventilation, ingress and egress.

(114a) "Rowhouse" means a place of abode not more than 3 stories in height, arranged to accommodate 3 or more attached, side by side or back to back living units.

(114b) **RURAL SCHOOL BUILDING.** A rural school building is a building used solely for instructional purposes, is located outside of the corporate limits of a city or village, is not more than one story in height and contains not more than 2 classrooms.

(115) **SETBACK.** * Refers to the open space between the property line or public thoroughfare and the nearest part of the building. Unenclosed ter-

*See Appendix A for further explanatory material.

aces, slabs, or stoops without roofs or walls may project into this open space or setback.

(116) **SHAFT.** A vertical opening in a building extending through one or more stories and/or roof, other than an inner court.

(117) **SHALL.** A term for mandatory use under the provisions of this code.

(118) **SIGNS.** A structure that is intended, designed, or used for advertising, display, identification, announcements, or related purposes; this includes signs, screens, billboards, and other advertising devices of any type.

(119) **SIMPLE SUPPORT.** A flexural member where the supports or the adjacent construction, or both, allows free rotation of the ends of the member and horizontal displacement when subject to a gravity load or a temperature change, or both.

(119a) "Sleeping area" means the area of residential buildings in which bedrooms or sleeping rooms are located. Bedrooms or sleeping rooms separated by other use areas such as kitchens or living rooms, but not bathrooms, are considered as separate sleeping areas. Each individual room or suite of rooms in hotels, motels, dormitories or congregate living facilities is considered a separate sleeping area.

(119b) "Smoke detector" means a device which detects particles or products of combustion other than heat.

(119c) "Solid-fuel equipment" means equipment burning solid rather than gas or liquid fuel.

Note: Typical solid fuels are coal and wood.

(120) "Space heater" means a fuel-fired vented, self-contained free-standing or wall recessed heating appliance.

(120a) "Spandrel" means that portion of wall filling the space between the top of a window in one story and the sill of the window in the story above.

(120b) **STEP.** Step is a unit consisting of one riser of not more than 7½ inches and one tread of not less than 9½ inches, alone or in a series.

(121) **STORIES, NUMBER OF.*** The number of stories of a multistory building includes all stories except the basement, ground floor, attic or interior balcony and mezzanine floor. (Also see ILHR 51.02 (14).)

(122) **STORY.** The space in a building between the surfaces of any floor and the floor next above or below, or roof next above, or any space not defined as basement, ground floor, mezzanine, balcony, penthouse or attic. (Also see "Stories, Number of.")

(124) "Street" means any legally established public thoroughfare or all-weather hard surface area 30 feet or more in width whether designated or not by name or number such as avenue, boulevard, circle, court, drive, lane, place, road or way. Streets must extend at least 50% of the length of the side of the building and must be accessible to fire fighting equipment.

*See Appendix A for further explanatory material.

(125) **STRUCTURE.** A structure is an assembly of materials forming a construction for occupancy or use meeting the definition of place of employment or public building.

Note: Structures include, among others, buildings, stadiums, tents, reviewing stands, observation towers, radio and television towers, water tanks, piers, wharves, shelters, canopies, and display signs.

(126) **SUPPORT (RESTRAINED).** See "Restrained Support."

(127) **SUPPORT (SIMPLE).** See "Simple Support."

(128) **TEMPERED AIR.** Air transferred from heated area of building.

(129) **TEMPERED OUTSIDE AIR.** Outside air heated before distribution.

(130) **TERRACE.** An unenclosed exterior structure at or near grade having a paved, floored, or planted platform area adjacent to an entrance or to the exterior walls for a building or structure and having no roof.

(130a) "Townhouse" means an apartment building where each living unit is served by an individual exterior exit within 3 feet of the exit discharge grade.

(131) **TREATED WOOD (FIRE-RETARDANT).** See "Fire Retardant-Treated Wood."

(132) **UNIT HEATER (HIGH STATIC PRESSURE TYPE).** A direct-fired suspended or floor standing, self-contained, automatically controlled and vented, heating appliance having an integral means for circulation of air against 0.2 inch or greater static pressure.

(133) **UNIT HEATER (LOW STATIC TYPE).** A direct-fired suspended, self-contained automatically controlled, vented heating appliance, having integral means for circulation of air by means of a propeller fan or fans.

(134) **VENEERED WALL.** See "Wall (veneered)."

(135) **VENTILATING SYSTEM (EXHAUST).** Any combination of building construction, machinery, devices or equipment, designed and operated to remove harmful gases, dusts, fumes or vitiated air, from the breathing zone of employes and frequenters.

(136) **VENTILATION.** The process of supplying or removing air by natural or mechanical means, to or from any space.

(137) **VENTILATION (GRAVITY EXHAUST).** A process of removing air by natural means, the effectiveness depending on atmospheric condition, such as difference in relative density, difference in temperature or wind motion.

(138) **VENTILATION (MECHANICAL).** The process of supplying or removing air by power-driven fans or blowers.

(139) **VERTICAL EXIT.** A means of egress used for ascension or descension between 2 or more floors, or other levels, and shall include approved exterior stairways, automatic (moving) stairways, fire escapes, ramps, stairways, and smokeproof stair towers.

(139a) **VOLUME (TOTAL).** The "total volume" (cube or cubage) of a building is the actual cubic space enclosed within the outer surfaces of the outside or enclosing walls and contained between the outer surfaces

of the roof and the underside of the lowest floor. The volume of structures without enclosing walls (canopies, roofed shelters and similar structures) will be computed by projecting imaginary vertical planes as the enclosing walls at the outer surface of the exterior supports or columns. For cantilevered structures with interior supports, the imaginary vertical planes will be projected at the farthest roof projection or overhang.

Note: The definition of total volume requires the cube of dormers, penthouses, vaults, pits, enclosed porches and other enclosed appendages to be included as a part of the cube of the building. It does not include the cube of courts or light shafts, open at the top, or the cube of outside steps, cornices, parapets, or open porches or loggias.

(140) WALL. A structural element which is vertical or within 30° of vertical, serving to enclose space, form a division, or support superimposed weight.

(141) WALL (BEARING). Any wall which supports a load in addition to its own weight.

(142) WALL (CAVITY). A wall built of masonry units or of plain concrete, or a combination of these materials, so arranged to provide an air space within the wall, and in which the facing and backing (inner and outer parts) of the wall are tied together with metal ties.

(143) WALL (CURTAIN). An exterior nonbearing wall.

(144) WALL (DIVISION). * (a) *Building division*. A wall used for separation between 2 buildings on the same property identical in construction to a party wall.

(b) *Fire division*. A wall extending from the lowest floor level to or through the roof to restrict the spread of fire.

(145) WALL (EXTERIOR). Any outer enclosing wall of a building or structure.

(146) WALL (FRAMING). Wall framing shall include columns, studs, beams, girders, lintels and girts.

(147) WALL (HOLLOW BONDED). Wall built of masonry units with or without any air space within the wall, and in which the facing and backing of the wall are bonded together with masonry units.

(148) WALL (NONBEARING EXTERIOR). Wall which supports no vertical load other than its own weight.

(148a) WALL (NONBEARING INTERIOR). See "Partition."

(149) WALL (PANEL). An exterior nonbearing wall in skeleton construction.

(150) WALL (PARAPET). That part of a wall entirely above the roof line.

(151) WALL (PARTY). * Walls used for separation between 2 buildings on the property line between adjoining properties.

(152) WALL (RETAINING). Wall used to resist laterally imposed pressures.

*See Appendix A for further explanatory material.

(153) **WALL (VENEERED).** Wall having facing which is attached to the backing but not so bonded as to exert common action under load.

(153a) **WAREHOUSE.** A warehouse is a place adapted to the reception and storage of goods and merchandise.

(154) **YARD (FRONT).** An open, unoccupied space unobstructed to the sky, extending across the full width of a lot, or plot of land between the street line and the base of a front building wall. Unenclosed terraces, slabs or stoops without roofs or walls may project into this open space.

History: Cr. Register, June, 1972, No. 198, eff. 1-1-73; renum. (1) to be (1a), r. and recr. (10), (54), (67) and (121), cr. (1), (5a), (22a), (56a), (57a), (67a), (76a), (106a) and (148a), Register, September, 1973, No. 213, eff. 10-1-73; cr. (102a), (104a) and (105a), Register, December, 1974, No. 228, eff. 1-1-75; cr. (7a), (41a), (139a) and (153a) and am. (125), Register, December, 1976, No. 252, eff. 1-1-77; cr. (42a), (42b), (42c), (42d), and (120a), am. (139a), Register, December, 1977, No. 264, eff. 1-1-78; am. (23) to (26), (97) and (139a), r. (86) (c), Register, December, 1978, No. 276, eff. 1-1-79; cr. (16a), (71a), (79a) and (114a), Register, May, 1980, No. 293, eff. 6-1-80; am. (1) and (124), r. (123), r. and recr. (120), renum. (102a) to be (102b), renum. (114a) to be (114b), cr. (19a), (36a), (36b), (36c), (37a), (38a), (38b), (71b), (75a), (80a), (82a), (102a), (114a), (119a), (119b), (119c) and (130a), Register, December, 1981, No. 312, eff. 1-1-82; renum. (71a) to be (71c), cr., (68a), (71a), (86a) and (93a), Register, February, 1982, No. 314, eff. 3-1-82; r. and recr. (7a), renum. (19a) to be (19b), cr. (7b) and (19a), Register, June, 1983, No. 330, eff. 7-1-83; renum. (120a) to be (120b), cr. (3a), (57b), (58a), (58b) and (120a), r. and recr. (13), am. (86) (a), (104) and (120), Register, December, 1983, No. 336, eff. 1-1-84; am. (7b), Register, February, 1984, No. 338, eff. 3-1-84; cr. (5b), (11a) and (29a), am. (75a) and (99), r. and recr. (104) and (114a), Register, August, 1985, No. 356, eff. 1-1-86; reprinted to correct error in (99), Register, May, 1988, No. 389.

Standards for Classes of Construction

ILHR 51.015 Scope. This section covers minimum standards for common types of building designs currently being constructed. This section does not specifically include classification for uncommon building designs such as shells, domes, space frames, inflatable and similar types of designs. The standards contained herein shall be used as a guide for such uncommon building designs to achieve the degree of safety intended by these standards.

History: Cr. Register, June, 1972, No. 198, eff. 1-1-73; renum. Register, September, 1973, No. 213, eff. 10-1-73.

ILHR 51.02 General requirements. (1) FIRE-RESISTIVE RATINGS. The fire-resistive ratings shown in "Classes of Construction" Table 51.03-A are to satisfy the structural integrity end point for the time specified. For heat transmission end point requirements see s. ILHR 51.042 (5).

(2) **SUBSTITUTE.** Substitution of a building element fire-resistive rating will be permitted in any class of construction providing it is equal to or better than the required fire-resistive rating as specified in Table 51.03-A.

(a) Construction requiring the use of noncombustible material shall not be replaced by combustible construction regardless of fire-resistive rating unless mentioned specifically under classes of construction standards.

(b) Noncombustible construction may be substituted for combustible construction provided the fire-resistive rating indicated in Table 51.03-A is equal to or better than that noted for combustible construction.

Note: See ILHR 64.41 (1) for requirements pertaining to combustible ceiling materials used in conjunction with air-handling plenums.

(c) Fire-retardant treated wood exposed to high humidity or accelerated weathering shall be pressure impregnated and so identified. Subsequent to treatment, lumber 2 inches or less in thickness shall be dried to a moisture content of 19% or less, and plywood to a moisture content of 15% or less.

Note: The department will accept fire-retardant treated lumber and plywood which meet the standards of the American Wood Preservers Association, "Fire-Retardant Treatment by Pressure Processes," and ASTM D 2898, "Standard Methods of Test for Durability of Fire-Retardant Treatment of Wood."

(3) **FLOOR FRAMING.** (a) All floor framing shall satisfy the requirements of Table 51.03-A, whether floor system is considered part of a story or not, unless more restrictive requirements are noted under the occupancy chapters of this code.

(4) **EXTERIOR WALL CONSTRUCTION.** (a) All exterior walls which are in contact with the soil shall be of masonry or concrete except that all-weather wood foundations are permitted if constructed in accordance with the provisions outlined in s. ILHR 53.64.

(b) Exposed exterior walls between the first floor structural system and grade shall be of masonry or concrete except as follows:

1. Walls may be constructed of material other than masonry or concrete providing the following conditions are satisfied:

a. The construction shall meet the requirements of Table 51.03-A for specified class of construction.

b. Any portion of exposed wall above grade and below the first floor structural system, when other than masonry or concrete, shall be counted as a story, and is also considered when determining height of wall.

Note: Buildings utilizing wood foundations in accordance with the provisions outlined in s. ILHR 53.64 will be limited to 3 levels (including 2-story and basement, 2-story and ground floor, or 3-story with treated wood frost wall and no crawl space or basement).

(c) 1. Except as provided in subd. 2., fenestration in-fill panels in the exterior walls of existing buildings of types 1, 2, 3, 5A and 5B construction meeting the percentage of openings requirements of Table 51.03-B shall be of noncombustible construction.

2. a. The studding and structural framework may be of fire retardant treated wood.

b. The interior finish of the in-fill panel may be of combustible materials providing the materials comply with the provisions of s. ILHR 51.07.

c. Foam plastic insulation complying with the provisions of s. ILHR 51.06 may be used in the construction of the in-fill panels provided the foam plastic is protected on both sides by an approved thermal barrier as specified in s. ILHR 51.06 (3).

3. In-fill panels located in exterior walls required to have a fire-resistive rating need not be constructed to provide the hourly rating provided the panels satisfy the requirements of this section.

4. The exterior finish of the in-fill panel shall comply with the requirements of Table 51.03-A for the class of construction of the building in which the panel is located except that the exterior finish of in-fill panels

located in buildings of types 5A or 5B construction need not be of masonry.

(5) **INTERIOR WALL CONSTRUCTION.** (a) Openings in partitions and interior bearing walls shall be protected if such walls serve as required building division, fire division or fire separation walls.

1. Openings shall be protected by approved fire door or fire window assemblies as specified in ss. ILHR 51.047 and 51.048, or fire damper or fire curtain door assemblies as specified in s. ILHR 64.42.

Note: Openings in walls other than those specified above need not be protected except to satisfy structural integrity end point for the time specified.

(7) **BUILDING LOCATIONS.** (a) When the distance between buildings located on the same property is less than 10 feet, the following shall apply:

1. Where the combined gross area for these buildings is less than that allowable for one building the exterior wall shall satisfy minimum requirements listed for class of construction in Table 51.03-A.

a. Buildings classified as wood frame under s. ILHR 51.03 (7) or (8) shall have exterior walls with a fire-resistive rating of not less than that required for these buildings when satisfying the 10 feet to 30 feet distance to property line shown in Table 51.03-A.

2. Where the combined gross area for these buildings is greater than that allowable for one building, one of the opposing walls shall be not less than a 4-hour fire-resistive rated fire division wall or building division wall, whichever applies. Where buildings are of different classes of construction, the lesser allowable gross area shall apply.

(8) **INTERIOR BALCONY OR MEZZANINE.** Interior balconies or mezzanine floors shall have fire-resistive ratings as required for the story in which it is located.

(9) **IMBEDDED MATERIAL.** (a) Except as provided in par. (b), pipes, wires, cables, ducts or other service equipment shall not be imbedded in the required fire-resistive protection of any structural member.

(b) 1. Pipes, wires, cables, ducts or other service equipment may be imbedded or installed as permitted in approved fire-rated assemblies.

2. Pipes, wires, cables, metallic ducts or other service equipment may be imbedded or installed in fire-resistive assemblies of 2 hour rating or less in buildings of Types No. 4 to 8 construction. The pipe, wire, cable, metallic duct or other service equipment shall be contained within the fire-resistive rated assembly.

(10) **EXPOSED EXTERIOR STRUCTURAL COLUMNS AND FRAMING.** The required fire-resistive hourly rating may be omitted on noncombustible columns and framing when the building does not exceed 2 stories and the fire separation to the center of a street, or to the property line or buildings on the same property, is greater than 30 feet.

(11) **PROTECTION OF VERTICAL OPENINGS.** (a) Except as specified in ss. ILHR 54.08, 55.09, 57.08 and in par. (b), stairways, elevator shafts and other vertical openings, which serve 2 or more floor levels, shall be enclosed with fire-resistive rated construction equal to or better than the hourly ratings specified in Table 51.03-A. Stairways serving as required

means of egress shall comply with the requirements specified in s. ILHR 51.18.

(b) *Exceptions.* Vertical openings need not be enclosed under the following conditions:

1. Serving and contained within individual living units;
2. Serving raised or depressed areas, open mezzanines or open balconies contained within a single story;
3. Serving 2 floor levels in buildings containing chs. ILHR 55 to 58 or 60 to 62 occupancies and the opening is not a required means of egress provided the opening is separated from any exit access corridor or exit stairway by fire-resistive rated construction having at least the hourly rating specified for fire-rated enclosures as specified in line 20 of Table 51.03-A; or
4. As permitted by chs. ILHR 54 through 62.

(c) Openings in required exit enclosures shall be limited to exit doors serving public passageways and corridors or serving floors occupied by a single tenant.

(12) **PARAPET WALLS.** (a) Parapet walls shall be provided on exterior walls closer than 10 feet to a property line or to other buildings on the same property except as exempted under subd. 4. Parapet walls shall satisfy the following requirements:

1. Parapets shall not be less than 2 feet in height;
2. The minimum thickness of masonry parapets shall be 8 inches;
3. Parapets shall have fire-resistive ratings as specified for exterior walls in Table 51.03-A; and
4. Parapets are not required on exterior walls which front streets and alleys or where exterior walls connect with roofs of noncombustible construction.

(b) All parapet walls shall be properly coped with noncombustible weatherproof material.

(13) **FIRE DIVISION WALLS.** (a) Fire division walls shall have not less than a 4-hour fire-resistive rating as specified in s. ILHR 51.04 and shall comply with one of the following conditions:

1. a. Except as provided in subpar. b, the fire division wall shall extend 3 feet above the roof. Where a difference in roof elevations occurs at the fire division, the parapet height shall be measured from the lower roof elevation.

b. Where a difference in roof elevations occurs at the fire division wall in buildings of Type No. 4 construction with combustible exterior walls, Type No. 7 or No. 8 construction, the fire division wall shall extend above the lower roof to the high roof elevation and shall be unpierced. In all cases, the fire division wall shall extend at least 3 feet above the lower roof elevation.

2. The wall shall connect and make tight contact with roof decks of at least 2-hour fire-resistive noncombustible construction on both sides of the wall; or

3. The wall shall connect and make tight contact with roofs of noncombustible construction on both sides of the walls, and the roofs shall be noncontinuous at the wall.

Note: Built-up roofs, including those having class A rating, are considered combustible and do not meet the requirements of this section.

(b) Structural members shall not continue through or over the fire wall.

(c) 1. All openings in fire division walls shall be protected by fire-resistive door assemblies as specified in s. ILHR 51.047.

2. The total area of all openings in any fire division wall in any one story shall not exceed 25% of the area of the wall in that story.

(14) DETERMINATION OF NUMBER OF STORIES.* For purposes of establishing the maximum allowable stories in the various classes of construction stated in s. ILHR 51.03, the number of stories shall be determined on the following basis:

(a) The first floor shall be determined first and this level shall satisfy the following conditions:

1. Is the lowest floor having one or more required exits for that floor and for any floor above or below; and

a. If condition stated in subd. 1. is not satisfied, the highest floor level shall be considered the first floor.

2. a. Except as provided in subpar. b., the elevation of the first floor and the sills of all required exit discharges from the first floor shall be at or not more than 3 feet above an exit discharge grade.

b. Existing buildings to be licensed as child day care centers or to be converted to sheltered facilities for battered women shall comply with the requirements specified in ss. ILHR 57.015 and 60.105.

(b) 1. Except as provided in subd. 2., an interior balcony or mezzanine floor which exceeds 25,000 square feet or $\frac{1}{2}$ of the net main area enclosed within exterior walls or fire division walls or both, whichever is least, shall be counted as a story. The area of the mezzanine may not be added to the main floor area to determine the maximum area of the mezzanine.

2. An open balcony or mezzanine within a single living unit or tenant space which exceeds $\frac{1}{2}$ of the net area enclosed within the walls of that living unit or tenant space shall be counted as a story.

(c) Penthouse with a total area that exceeds 50% of the total roof area shall be counted as a story.

(d) Construction according to sub. (4) (b) 1. b. shall also be counted as a story.

(e) Total number of stories shall include the first floor plus all stories above and those stories determined by pars. (b), (c) and (d).

*See Appendix A for further explanatory material.

1. Floor levels satisfying the definition of basement, ground floor, attic, interior balcony and mezzanine floor, unless otherwise stated, shall not be counted as a story.

(15) **DECORATIVE COMBUSTIBLE MATERIALS.** Decorative combustible materials may be applied to all required noncombustible exterior surfaces of "0" hourly rated construction or better, up to a limit of 10% of the surface area within any 100 lineal feet of the building.

(a) *Exception.* Fire-retardant treated wood may be applied to all required noncombustible exterior surfaces of "0" hourly rated construction without limit.

(18) **ACCESS TO ATTIC AND ROOF.** (a) *Attic.* Every attic compartment shall be provided with access from the floor level immediately below it. The access opening shall be at least 20 by 30 inches and shall be located above the stair landing or in an accessible location.

Note: A single access point to the attic from the floor level immediately below will be acceptable if all the attic compartments are interconnected with access openings of at least 20 by 30 inches.

(b) *Roof.* 1. Except as provided in subd. 2., all buildings more than 2 stories, or 25 feet in height, where the slope of the roof is less than 3 in 12, shall be provided with a means of access to the main roof from the floor level immediately below. The roof opening shall be at least 20 by 30 inches and shall be provided with a permanent ladder or stairway.

2. Roof access shall not be required in 3 story buildings without attic space.

(19) **ATTIC COMPARTMENTALIZATION.** (a) Except as provided in par. (b), attics of combustible construction shall be divided into areas not greater than 3,200 square feet by firestopping as specified in s. ILHR 53.63 (1) (d).

1. Compartmentalization shall extend into the eave and soffit areas to provide a complete separation between compartments.

2. Panels for access openings in compartment walls shall be equipped with self-closing devices and shall normally be kept closed.

(b) Attic compartmentalization need not be provided in buildings completely protected, including the attic space, by an automatic fire sprinkler system.

(20) **CLASS OF CONSTRUCTION SEPARATION.** (a) Except as provided in par. (b) and s. ILHR 62.93, portions of buildings of different classes of construction, as specified in s. ILHR 51.03, shall be separated by fire division walls as specified in s. ILHR 51.02 (13) or the building classification will be reduced to the lowest class of construction utilized.

(b) Portions of health care facilities of different classes of construction, as specified in s. ILHR 51.03, shall be separated by 2-hour rated fire-resistant construction as specified in ss. ILHR 51.04 to 51.049 or the building classification shall be reduced to the lowest class of construction utilized.

(21) **HEIGHT LIMITATIONS.** (a) Except as provided in par. (b), the height of buildings shall be limited as specified in the appropriate occu-

pancy chapter for the building and as specified in s. ILHR 51.03 and Table 51.03-A for the class of construction utilized.

(b) The height limitations specified in s. ILHR 51.03 may be increased by one story and 10 feet in height in buildings, other than buildings within the scope of chs. ILHR 58, 60 and 61, when the building is completely protected by an automatic fire sprinkler system and the system is supervised and monitored as specified in s. ILHR 51.23 (9).

Note: See chs. ILHR 54 to 61 for specific application of height increases. Tables 54.01-2, 57.02-3 and 59.12-2 already include the one story height increase.

(22) **FIRE RESISTIVE RATINGS.** (a) Except as provided in par. (b), the fire resistive ratings specified in chs. ILHR 50 to 64 may be reduced in rating by one hour to a minimum of one hour in all buildings which are completely protected by an automatic fire sprinkler system and the system is supervised and monitored as specified in s. ILHR 51.23 (9).

(b) The fire resistive rating may not be reduced for the following:

1. The fire-resistive ratings specified in ch. ILHR 58;
2. The fire-resistive ratings specified for stairway enclosures in buildings more than 3 stories in height;
3. The fire-resistive ratings for buildings more than 60 feet in height; and
4. The fire-resistive ratings for buildings where increases in building area or building height due to automatic fire sprinkler system protection have been utilized.

History: Cr. Register, June, 1972, No. 198, eff. 1-1-73; r. (9) and (10), renum. (3) to be (4), (4), (5), (6), (7), (8) to be (6), (7), (8), (9), (10), am. (2) (a) cr. (3), (5), (11), (12), (13) and (14), Register, September, 1973, No. 213, eff. 10-1-73; am. (14) (d), Register, February, 1974, No. 218, eff. 3-1-74; r. and recr. (12) (a); am. (13) (c), Register, May, 1974, No. 221, eff. 6-1-74; cr. (11) (c) and (15), Register, July, 1974, No. 223, eff. 8-1-74; cr. (16) and (17), Register, December, 1974, No. 228, eff. 1-1-75; am. (5) (a) 1 and (14) (e) 1, cr. (18), Register, December, 1975, No. 240, eff. 1-1-76; am. (16) (b), Register, July, 1976, No. 247, eff. 8-1-76; cr. (2) (c), Register, December, 1976, No. 252, eff. 1-1-77; am. (15) and cr. (19), Register, December, 1977, No. 264, eff. 1-1-78; r. (16) and (17), Register, May, 1978, No. 269, eff. 7-1-78; am. (4) (a), (18) and (19), cr. (15) (a) and (20), Register, December, 1978, No. 276, eff. 1-1-79; am. (11) (a) and (c) (intro.), (13) and (19), r. and recr. (6) (b), Register, January, 1980, No. 289, eff. 2-1-80; r. and recr. (11), am. (14) (a) 2, r. (14) (a) 3, Register, December, 1981, No. 312, eff. 1-1-82; reprinted to correct error in (14) (a) 2, Register, February, 1982, No. 314; am. (11) (a) and (19), Register, October, 1982, No. 322, eff. 11-1-82; cr. (4) (c) and (13) (c), r. (6), am. (11) (b) 3, (14) (a) 2, and (20), Register, December, 1983, No. 336, eff. 1-1-84; am. (4) (c) 2, c., (9), (11) (b) 3., (13) (c) 2., (14) (b) and (18) (b), r. and recr. (13) (a) 1., Register, August, 1985, No. 356, eff. 1-1-86; emerg. cr. (21) and (22), eff. 9-6-86; cr. (21) and (22); Register, November, 1986, No. 371, eff. 12-1-86.

ILHR 51.03 Classes of construction standards. (1) **FIRE RESISTIVE TYPE A (NO. 1).** (a) A building is of fire-resistive construction if all the walls, partitions, piers, columns, floors, ceilings, roof and stairs are built of noncombustible material, with a fire-resistive rating as specified in Table 51.03-A.

1. Concealed draft openings in columns, walls and partitions shall be firestopped with noncombustible material at each floor level.

(b) All buildings of this classification shall not be restricted in height.

(c) Stairs and stair platforms shall be constructed of noncombustible material.

(d) Doors and windows may be of wood except as otherwise specified in s. ILHR 51.02 (5), Table 51.03-B, ss. ILHR 51.17, 51.18, 51.19 and 51.20, or in the occupancy chapters of this code.

1. Doors leading into main public corridors other than rated exit corridors shall be noncombustible or 20-minute fire door assemblies, as specified in s. ILHR 51.047 or equivalent, unless otherwise specified above.

Note: Public corridors are intended to include principal corridors serving a floor and leading directly to building exits, but do not include communicating passageways within a given use area.

(e) Bays, oriels, and similar exterior projections from the walls shall be constructed of material with fire-resistive ratings as required for exterior walls.

(f) Mansards shall be constructed of noncombustible material or fire-retardant treated wood.

CLASSES OF CONSTRUCTION TABLE 51.03-A FIRE RESISTIVE RATINGS IN HOURS

BUILDING ELEMENT	NUMBER OF STORIES	MODIFYING CONDITIONS		FIRE RESISTIVE TYPE A	FIRE RESISTIVE TYPE B	TYPES OF CONSTRUCTION								APPLICABLE NOTES
		SEE NOTES f g	BLDG SETBACK DIS. TO P/L OR TO OTHER BLDG. ON SAME PROP.			BEARING OR NONBEARING	METAL FRAME PROTECTED	HEAVY TIMBER	EXTERIOR MASONRY, PROT.	EXTERIOR MASONRY, UNPROT.	METAL FRAME UNPROTECTED	WOOD FRAME PROTECTED	WOOD FRAME UNPROTECTED	
				NO. 1	NO. 2	NO. 3	NO. 4	NO. 5A	NO. 5B	NO. 6	NO. 7	NO. 8		
1. INTERIOR SUPPORTS (COLUMNS, PIERS, FRAME LEGS, POSTS)	Over 8 stories or more than 85 ft. in height			NC-4	NP	NP	NP	NP	NP	NP	NP	NP	a d	
2.	8 stories or 85 ft. in height or less			NC-3	NC-2	See s. ILHR 51.03 (3) NC-1	See s. ILHR 51.03 (4) H.T. or 1	See s. ILHR 51.03 (5) 1	See s. ILHR 51.03 (5) 0	See s. ILHR 51.03 (6) NC-0	See s. ILHR 51.03 (7) 1	See s. ILHR 51.03 (8) 0	a d	
3. FLOOR FRAMING (BEAMS, GIRDERS, JOISTS, SLABS, DECK)	More than 2 stories			NC-3	NC-2	See s. ILHR 51.03 (3) NC-1	See s. ILHR 51.03 (4) H.T. or 1	See s. ILHR 51.03 (5) 1	See s. ILHR 51.03 (5) 0	See s. ILHR 51.03 (6) NC-0	1	NP	a	
4.	2 stories or less			NC-2	NC-1	NC-1	See s. ILHR 51.03 (4) H.T. or 1 1 Story-HP or 0	1	0	See s. ILHR 51.03 (6) NC-0	1	0	a	
5. ROOF FRAMING (TRUSSES, BEAMS, GIRDERS, JOISTS, FRAME RAFTERS, PURLINS, DECK)	Over 8 stories or more than 85 ft. in height			NC-2	NP	NP	NP	NP	NP	NP	NP	NP	a	
6.	3 to 8 stories or 85 ft. in height or less			NC-2	NC-1-1/2	See s. ILHR 51.03 (3) NC-1	See s. ILHR 51.03 (4) H.T. or 1	See s. ILHR 51.03 (5) 1	See s. ILHR 51.03 (5) 0	See s. ILHR 51.03 (6) NC-0	1	NP	a	
7.	2 stories, or under 35 ft. in height			NC-1	NC-1	NC-1	See s. ILHR 51.03 (4) H.T. or 1	See s. ILHR 51.03 (5) 1	See s. ILHR 51.03 (5) 0	NC-0	See s. ILHR 51.03 (7) 1	0	a	
8.	1 story - roof framing more than 20 ft. above fl.			NC-0	See s. ILHR 51.03 (2) NC-0	NC-0	See s. ILHR 51.03 (4) H.T. or 1	0	0	0	0	0	a	
9.	1 story - roof framing 20 ft. or less above fl.			NC-1	NC-1	NC-1	See s. ILHR 51.03 (4) H.T. or 1	1	0	0	See s. ILHR 51.03 (7) 1	0	a	
10. ROOF COVERING				CLASS A	CLASS A	CLASS A	CLASS B	CLASS B	CLASS B	CLASS C	CLASS C	CLASS C	a	
11. EXTERIOR WALLS & COURT WALLS		Less than 10 ft.	Bearing	NC-4	NC-3	NC-2	NC-2	2	2	NC-2	See s. ILHR 51.03(7)(e) NP	See s. ILHR 51.03(8)(d) NP	a d e f k	
12.	3 stories	10 ft. to 30 ft. inclusive	Bearing	NC-3	NC-2	NC-3/4	1	2	1	NC-0	See s. ILHR 51.03(7)(f) NP	NP	a c d e	
	2 stories or less										1	0	f k	
13. (NOT INCLUDING INTERIOR FINISH ATTACHED TO INSIDE SURFACE OF WALL)		Over 30 ft.	Bearing	NC-2	NC-1	NC-0	1	2	1	NC-0	1	0	a c d e f k	
14.		Less than 10 ft.	Nonbearing	NC-2	NC-2	NC-1	NC-1	2	1	NC-1	See s. ILHR 51.03(7)(e) NP	See s. ILHR 51.03(8)(d) NP	a d e f k	
15.	3 stories	10 ft. to 30 ft. inclusive	Nonbearing	NC-1	NC-1	NC-0	1	2	1	NC-0	See s. ILHR 51.03(7)(f) NP	NP	a c d e	
	2 stories or less										1	0	f k	
16.		Over 30 ft.	Nonbearing	NC-0	NC-0	NC-0	3/4	1	0	NC-0	1	0	a c d e f h k	
17. INTERIOR WALLS BEARING				NC-3	NC-2	NC-1	1	1	1	NC-0	1	0	a j	
18. PARTITIONS				NC-0	NC-0	NC-0	0	0	0	0	0	0	a j	
19. REQUIRED EXIT CORRIDOR ENCL.	Over 3 stories			NC-2	NC-2	NC-2	2	2	1	1	1	1	a	
	3 stories or less													
20. FIRE ENCLOSURE (STAIRWAYS, ELEVATORS, VERTICAL SHAFTS)	Over 3 stories			NC-2	NC-2	NC-2	2	2	NP	NP	NP	NP	a f	
	3 stories or less			NC-2	NC-2	NC-1	1	1	1	1	1	1	a f	
21. PENTHOUSE WALLS				NC-0	NC-0	NC-0	0	NC-0 or 3/4	NC-0 or 3/4	0	0	0	a h	
22. PENTHOUSE ROOF				NC-0	NC-0	NC-0	0	0	0	0	0	0	a b	

KEY TO ABBREVIATIONS

NC - Noncombustible
NP - Not Permitted
H.T. - Heavy Timber
P/L - Property Line

- a - See occupancy sections of the code for other basic requirements and more restrictive limitations.
- b - Roof covering same as for main building.
- c - Walls of solid wood 4 inches in thickness are acceptable as equal to one hour fire-resistive rating.
- d - Fire-resistive requirements also apply for those bracing members required for gravity loading.
- e - Refer to Table 51.03-B for allowable areas for windows and other openings in exterior walls.
- f - For exceptions refer to s. ILHR 51.02.
- g - Setbacks and distances to P/L or other buildings on same property do not apply to P/L along streets.
- h - Approved fire-retardant treated wood will be accepted in lieu of 3/4-hour fire-resistive ratings.
- j - For openings in partitions and interior bearing walls, see s. ILHR 51.02.
- k - Hourly ratings specified as for fire exposure from the inside of the building only.

KEY EXAMPLE TO READING CHART

0 = 0 (No Hour Rating)
1 = Combustible or Noncombustible 1 Hour Rating
NC-0 = Noncombustible 0 Hour Rating

TABLE 51.03-B
 MAXIMUM TOTAL ALLOWABLE AREA OF WINDOWS OR OTHER WALL OPENINGS
 IN PERCENT OF TOTAL EXPOSED EXTERIOR WALL SURFACE

Setback from Property Line, or Other Walls on Same Property ¹	Class of Construction				
	1. Fire-Resistive "A" 2. Fire-Resistive "B" 3. Metal Frame Protected 4. Heavy Timber 5. Exterior Masonry	6. Metal Frame Unprotected	7. Wood Frame Protected	8. Wood Frame Unprotected	
	Bearing Wall	Nonbearing Wall			
Less than 5'	No Openings	No Openings	No Openings	Not Permitted	Not Permitted
5' to less than 10'	20% ² Fire window reqd. ³	30% ² Fire window reqd. ³	30% ¹	Not Permitted	Not Permitted
10' to less than 30'	30% ¹	40% ²	40% ²	40% ²	40% ²
30' or over	No Limit	No Limit	No Limit	No Limit	No Limit

¹Does not apply to property lines along streets.

²Tabulated percentage of openings shall be applied to each 100 lineal feet of wall. This tabulation will not allow wing walls or high parapets, etc. to be used to increase exposed wall areas and thereby increase allowable total area of openings. Where openings are permitted, such openings protected with approved automatic-closing, 3-hour fire door or shutter assemblies—No Limit.

³Fire windows shall be as required for moderate fire exposure—see ILHR 51.048.

1. The wall construction behind mansard shall extend to underside of roof deck and shall have a fire-resistive rating of not less than that specified for exterior walls in Table 51.03-A.

(g) Penthouses and other roof structures shall have enclosing walls of noncombustible construction and roof framing and coverings shall be equal to that specified in Table 51.03-A. Wood cooling towers are permitted.

(j) In required fire-resistive floor and roof assemblies one electric outlet box, not exceeding 16 square inches in area, may be installed in such ceilings in each 90 square feet of ceiling area. Recessed electric fixtures shall have protection boxes built above the fixture, constructed of approved fire-resistant material of rating equal to that of the ceiling, to cover the opening in case fixture is displaced. Duct openings in ceilings shall be protected by fire dampers.

(2) FIRE-RESISTIVE TYPE B (NO. 2). (a) A building is of fire-resistive construction if all the walls, partitions, piers, columns, floors, ceilings, roof and stairs are built of noncombustible material, with a fire-resistive rating as specified in Table 51.03-A.

(b) All buildings of this classification shall not exceed a height of 85 feet, in which height there shall be not more than 8 stories.

(c) Roofs. Where roof framing is greater than 20 feet above the floor, or highest level of any balcony, roof decks may be:

1. Matched or splined wood roof decking of not less than 2 inches in nominal thickness;

2. Solid lumber not less than 3 inches in nominal thickness, set on edge securely fastened together;

3. Approved 1½ inch thick plywood with exterior glue, tongue and groove with all end joints staggered and butting on centers of beams spaced not over 4 feet apart; or

4. Other forms of roof decks, if of noncombustible material.

(d) Stairs and stair platforms shall be constructed of noncombustible material.

(e) Doors and windows may be of wood except as otherwise specified in s. ILHR 51.02 (5), Table 51.03-B, ss. ILHR 51.17, 51.18, 51.19 and 51.20, or in the occupancy chapters of this code.

1. Doors leading into main public corridors other than rated exit corridors shall be noncombustible or 20-minute fire door assemblies, as specified in s. ILHR 51.047 or equivalent, unless otherwise specified above.

Note: Public corridors are intended to include principal corridors serving a floor and leading directly to building exits, but do not include communicating passageways within a given use area.

(f) Bays, oriels, and similar exterior projections from the walls shall be constructed of material with fire-resistive ratings as required for exterior walls.

(g) Mansards shall be constructed of noncombustible material or fire-retardant treated wood.

1. The wall construction behind mansard shall extend to underside of roof deck and shall have a fire-resistive rating of not less than that specified for exterior walls in Table 51.03-A.

(h) Penthouse and other roof structures shall have enclosing walls of noncombustible construction and roof framing and coverings shall be equal to that specified in Table 51.03-A. Wood cooling towers are permitted.

(3) **METAL FRAME—PROTECTED (NO. 3).** (a) A building is of metal frame protected construction if the structural parts and enclosing walls are of metal, or metal in combination with other noncombustible materials, with time resistance ratings as set forth in Table 51.03-A.

(b) All buildings of this classification shall not exceed a height of 75 feet, in which height there shall be not more than 4 stories.

(c) Stairs and stair platforms shall be constructed of noncombustible material.

(d) Bays, oriels and similar exterior projections from the walls shall be constructed of material with fire-resistive ratings as required for exterior walls.

(e) Mansards shall be constructed of noncombustible material or fire-retardant treated wood.

1. The wall construction behind mansard shall extend to underside of roof deck and shall have a fire-resistive rating of not less than that specified for exterior walls in Table 51.03-A.

(4) **HEAVY TIMBER (NO. 4).** (a) A building is of heavy timber construction if the structural frame consists of heavy timber or heavy timber in combination with metal, reinforced concrete or masonry, and all building elements are as set forth in Table 51.03-A unless otherwise exempted.

(b) All buildings of this classification shall not exceed a height of 75 feet, in which height there shall be not more than 4 stories.

(c) *Columns.* 1. Wood columns shall be not less than 8 inches, nominal, in any dimension when supporting floor loads and not less than 6 inches, nominal, in least dimension and not less than 8 inches, nominal, in other dimension when supporting roof loads only.

2. All wood columns in the structural frame shall be superimposed, end to end, one above the other, and joined by metal or wood connectors.

Note: See structural ch. ILHR 53 for design requirements.

(d) *Floor framing.* 1. Beams and girders of wood shall be not less than 6 inches, nominal, in any dimension and not less than 45 square inches in actual cross-sectional area.

2. Wood arches which support floor loads shall be not less than 8 inches, nominal, in any dimension.

3. Framed timber trusses supporting floor loads shall have members of not less than 8 inches, nominal, in any dimension.

4. Floor framing and structural framing of material other than wood shall have a fire-resistive protection of not less than one hour.

(e) *Roof framing.* 1. Beams and girders of wood shall be not less than 6 inches, nominal, in any dimension and not less than 45 square inches in actual cross-sectional area.

2. Wood arches, timber trusses, purlins and rafters for roof construction shall have members not less than 4 inches, nominal, in width and not less than 6 inches, nominal, in depth. Spaced members may be composed of 2 or more pieces not less than 3 inches, nominal, in thickness when blocked solidly throughout their intervening spaces or when such spaces are tightly closed by a continuous wood cover plate of not less than 2 inches, nominal, in thickness, secured to the underside of the members. Splice plates shall be not less than 3 inches, nominal, in thickness.

(f) *Floors.* 1. Wood floor construction shall be tongued and grooved, or splined lumber not less than 3 inches nominal thickness, or of solid lumber placed on edge and securely fastened together to make a floor not less than 4 inches, nominal, in thickness. A top layer of flooring of one inch nominal thickness shall be placed over all such floor construction.

(g) Stair construction may be of wood in buildings not exceeding 3 stories in height. In 4-story buildings, all stairs, platforms and stair construction shall be constructed of noncombustible material.

(h) *Roofs.* Roof decks shall be:

1. Matched or splined wood roof decking of not less than 2 inches in nominal thickness;

2. Solid lumber not less than 3 inches in nominal thickness, set on edge securely fastened together;

3. Approved 1½ inch thick plywood with exterior glue, tongue and groove with all end joints staggered and butting on centers of beams spaced not over 4 feet apart; or

4. Other forms of roof decks, if of noncombustible material.

(i) Bays, oriels, and similar exterior projections from the walls shall be constructed of material with fire-resistive ratings as required for exterior walls.

(5)* **EXTERIOR MASONRY, PROTECTED AND UNPROTECTED (NOS. 5A AND 5B).** (a) A building is of protected or unprotected exterior masonry construction if all exterior walls are constructed of masonry or reinforced concrete or of other materials in combination with a minimum 6 inch nominal masonry wall and all building elements are as set forth in Table 51.03-A unless otherwise exempted.

(b) All buildings of Type 5A classification shall not exceed a height of 50 feet, in which height there shall be not more than 4 stories and all buildings of Type 5B classification shall not exceed a height of 40 feet, in which height there shall be not more than 3 stories.

(c) The interior structural framing shall be metal, reinforced concrete, masonry or wood. Fire protection of metal or wood structural members shall be as specified in Table 51.03-A.

*See Appendix A for further explanatory material.

(d) In walls where fire protection is required, the bottom of lower flange of steel lintels supporting load-bearing masonry shall be protected for openings exceeding 12-foot spans.

(e) Floors, roofs, partitions and stairs may be of wood but no joist, rafter, stud or stringer shall be less than 2 inches in nominal thickness.

(f) Bays, oriels and similar exterior projections from the walls shall be constructed of material with fire-resistive ratings as required for exterior walls.

(g) A mansard shall be constructed entirely of noncombustible material or fire-retardant treated wood if it is subject to one of the following conditions:

1. If the mansard is closer than 20 feet to the adjoining property line or other building on the same property; or

2. If the vertical projected area of the mansard exceeds 30% of the area of the wall surface to which it is attached.

(h) The portion of exterior wall above the bearing points of the roof structural framing system and enclosing non-occupied space shall be considered part of the roof construction and shall comply with the requirements of Table 51.03-A for roof framing.

(6) METAL FRAME—UNPROTECTED (NO. 6). (a) A building is of metal frame unprotected construction if the enclosing walls are of unprotected metal or unprotected metal in combination with other noncombustible materials and all building elements are as set forth in Table 51.03-A unless otherwise exempted.

1. Heavy timber may be used for interior columns and floor framing.

2. Interior mezzanines and balconies within the first story may be constructed of one-hour fire-resistive construction.

(b) A pole building is considered type No. 6, metal frame unprotected construction, provided the following conditions are satisfied:

1. The poles supporting the roof only shall be at least 6 inches by 8 inches nominal in dimension. Poles supporting floors shall be 8 inches by 8 inches nominal in dimension. Poles may be built up from individual 2-inch nominal lumber if the pieces are bolted or glued and nailed together;

2. The girts shall be of noncombustible, fire-retardant treated wood or heavy timber construction;

3. The enclosing wall skin shall be of noncombustible materials. A non-structural 2" x 6" nominal wood skirt is permitted if it is in contact with the ground or foundation;

4. The roof cover shall have a class B rating or better; and

5. All other requirements of this section and Table 51.03-A are satisfied.

(c) All buildings of this classification shall not exceed a height of 50 feet, in which height there shall be not more than 3 stories.

(d) Stairs and stair platforms may be of wood with stringers not less than 2 inches in nominal thickness.

(e) Bays, oriels and similar exterior projections from the walls shall be constructed of material with fire-resistive ratings as required for exterior walls.

(7) **WOOD FRAME—PROTECTED (NO. 7).** (a) A building is of wood frame protected construction if the structural parts and enclosing walls are of protected wood, or protected wood in combination with other materials, with fire-resistive ratings at least equal to or better than those set forth in Table 51.03-A. Except as specified in s. ILHR 51.03 (5) (a), if such enclosing walls are veneered, encased or faced with stone, brick, tile, concrete, plaster or metal, the building is also termed a wood frame protected building.

(b) All buildings of this classification shall not exceed a height of 40 feet, in which height there shall be not more than 3 stories.

(c) Floors, roofs, partitions and stairs may be of wood but no joist, rafter, stud or stringer shall be less than 2 inches in nominal thickness.

(d) The structural members supporting the finished ceiling in the top-most story shall be protected on the underside by fire-resistive material acceptable in systems approved for one-hour fire-resistive ratings as covered in s. ILHR 51.04.

(e) Buildings of wood frame protected construction may be located less than 10 feet from a property line provided any wall closer than 10 feet from a property line is a 4-hour fire division wall, without openings, as specified in s. ILHR 51.02 (13).

(f) Buildings 3 stories in height of wood frame protected construction may be located less than 30 feet from a property line or other building on the same property provided any wall less than 30 feet from a property line or other building on the same property is a 4-hour fire division wall, without openings, as specified in s. ILHR 51.02 (13).

(g) Bays, oriels and similar exterior projections from the walls shall be constructed of material with fire-resistive ratings as required for exterior walls.

(8) **WOOD FRAME—UNPROTECTED (NO. 8).** (a) A building is of wood frame unprotected construction if the structural parts and enclosing walls are of unprotected wood, or unprotected wood in combination with other materials as set forth in Table 51.03-A. If such enclosing walls are veneered, encased or faced with stone, brick, tile, concrete, plaster or metal, the building is also termed a wood frame unprotected building.

(b) All buildings of this classification shall not exceed a height of 35 feet, in which height there shall be not more than 2 stories.

(c) Floors, roofs, partitions and stairs may be of wood but no joist, rafter, stud or stringer shall be less than 2 inches in nominal thickness.

(d) Buildings of wood frame unprotected construction may be located less than 10 feet from a property line provided any wall closer than 10 feet from a property line is a 4-hour fire division wall, without openings, as specified in s. ILHR 51.02 (13).

History: Cr. Register, June, 1972, No. 198, eff. 1-1-73; am. table A and (1) (d), renum. (1) (e) 1. to be (f), (1) (f) 1. a. to be (1) (f) 1., (1) (f) (g) (h) (i) to be (1) (g) (h) (i) (j), (2) (f) 1. to be (2) (g), (2) (g) 1. a. to be (2) (g) 1., (2) (g) (h) (i) to be (2) (h) (i) (j), (3) (d) 1. to be (e), (3) (e) 1. a. to (3) (e) 1., (7) (b) to be (c), (7) (c) to be (b), am. (2) (e), r. (4) (e) 3., r. and recr. (6) Register, August, 1985, No. 356

(a), cr. (7) (d), Register, September, 1973, No. 213, eff. 10-1-73; r. and recr. (6) (a), Register, May, 1974, No. 221, eff. 6-1-74; cr. (5) (a) 1. and 2.; am. table B and (5) (f) and r. and recr. (5) (g), Register, July, 1974, No. 223, eff. 8-1-74; am. (1) (d) 1. and (2) (e) 1., Register, December, 1974, No. 228, eff. 1-1-75; cr. (6) (a) 3, Register, December, 1977, No. 264, eff. 1-1-78; renun. (6) (b) to (d) to be (6) (c) to (e), cr. (6) (b), (7) (e) and (8) (d), am. (1) (f) (intro.), (h), (i), (2) (g) (intro.), (i), (j), (3) (e) (intro.), (4) (a), (5) (a) (intro.) and (8) (a), Register, December, 1978, No. 276, eff. 1-1-79; am. (1) (d) 1., (2) (e) 1., (5) (g) (intro.) and (6) (a) 3., cr. (5) (a) 3., Register, January, 1980, No. 289, eff. 2-1-80; am. (5), (7) (a), (b) and (e), (8) (d), cr. (9) (f), Register, December, 1981, No. 312, eff. 1-1-82; am. (5) (a) and (7) (f), Register, October, 1982, No. 322, eff. 11-1-82; am. table A, (3) (d) and (6) (e), r. (1) (h) and (i), (2) (i) and (j) and (6) (a) 13., cr. (4) (i) and (7) (g), r. and recr. (5) (h), Register, December, 1983, No. 336, eff. 1-1-84; am. (7) (f), Register, August, 1985, No. 356, eff. 1-1-86.

Fire-Resistive Standards for Materials of Construction

ILHR 51.04 Scope. This section shall include standards applicable to various types of fire-resistive construction. Requirements established herein are considered minimum safety standards and will not necessarily result in the most advantageous insurance rates.

History: Cr. Register, February, 1971, No. 182, eff. 7-1-71; r. eff. 8-1-71 and recr. eff. 1-1-72, Register, July, 1971, No. 187.

ILHR 51.042 General requirements. (1) Construction details and quality of material used for these systems must be those used by the testing laboratory for the test, and/or those dictated by good construction practice.

(2) (a) The minimum fire-resistive protection of a connection shall be equal to the maximum required for the members to which it is attached.

(3) For structural components with a fire-resistive rating obtained by test with restrained ends, the supporting structure shall be designed to provide for this restraint.

(4) (a) All products manufactured and tested according to ASTM standard methods prior to effective dates of standards specified in "Fire-Resistive Standards for Materials of Construction" shall be accepted unless the ASTM standard method used in the test is judged to be inadequate in comparison with the currently adopted standard method.

(5) The heat transmission requirements of ASTM E-119 (25b), with the exception of high hazard areas, penal and health care facilities and warehouses for combustible materials, may be reduced to one-half (1/2) of the hourly rating required by this code, but not less than one hour.

Note: For ASTM E-119 Standard adopted see s. ILHR 51.25 (49).

Note: See s. A 52.015 of Appendix A for additional information pertaining to high hazard occupancies.

(a) The fire-resistive rating for structural integrity required by this code shall be maintained where the heat transmission criteria has been reduced.

(6) The use of fire-resistive protection implies consent by owner to maintain material in a serviceable condition. Where this protection is concealed, provisions shall be made for periodic visual inspection of the structural insulating material at each story.

(7) In one-hour fire-resistive rated construction and in living unit separations as specified in s. ILHR 57.01(2), the ceiling may be omitted over unusable crawl space not more than 42 inches in height and the flooring may be omitted where unusable space occurs above.

(8) Structural elements which support building components or assemblies required to have a fire-resistive rating shall be protected to afford at least the same fire-resistive rating of the component or assembly supported.

History: Cr. Register, February, 1971, No. 182, eff. 7-1-71; r. eff. 8-1-71, and recr. eff. 1-1-72, Register, July, 1971, No. 187; cr. (7), Register, December, 1981, No. 312, eff. 1-1-82; cr. (8), Register, December, 1983, No. 336, eff. 1-1-84; am. (7), Register, August, 1985, No. 357, eff. 1-1-86.

ILHR 51.043 Approved rating methods. (1) Ratings of fire-resistive assemblies shall be determined by one of the following methods:

- (a) Test by approved testing laboratories (see s. ILHR 51.044).
- (b) Typical examples as listed in this code in lieu of approved test (see s. ILHR 51.045).
- (c) Approved method of calculation in lieu of approved test (see s. ILHR 51.046).

History: Cr. Register, February, 1971, No. 182, eff. 7-1-71; r. eff. 8-1-71, and recr. eff. 1-1-72, Register, July, 1971, No. 187.

ILHR 51.044 Approved testing laboratories. Fire rating tests conducted by recognized testing laboratories in accordance with the ASTM standards specified in Table 51.044 shall be accepted.

**TABLE 51.044
APPROVED TESTING LABORATORIES**

Name of Recognized Laboratories	ASTM STANDARD TESTS						
	E-84	E-108	E-119	E-136	E-152	E-163	E-648
Applied Research Lab. of Florida, Inc., Miami, FL	X	X	X	X	X	X	X
Commercial Testing Co. Inc., Dalton, GA	X	—	—	—	—	—	—
Factory Mutual Research, Norwood, MA	X	—	X	—	X	—	—
Forest Prod. Lab., Madison, WI*	—	—	X	—	X	—	—
Hardwood Plywood Mfgs. Assoc., Reston, VA	X	—	—	X	—	—	X
Nat'l. Bureau of St'd., Washington, DC	—	—	X	X	—	—	—
Ohio State Univ., Columbus, OH	—	—	X	X	X	X	—
Portland Cement Assoc., Skokie, IL	—	—	X	—	—	—	—
Product Fabrication Service, [PFS] Madison, WI	X	—	X	—	X	—	—
Southwest Research Inst., San Antonio, TX	X	—	—	—	—	—	—
Underwriters Lab., Inc., Northbrook, IL	X	X	X	X	X	X	X
Underwriters' Lab. of Canada, Scarborough, Ont., Canada	X	X	X	X	X	X	—
Univ. of Calif., Berkeley, CA	—	X	X	—	—	X	—
U.S. Testing Co., Hoboken, NJ	X	X	—	X	X	X	X
U.S. Testing Co., Los Angeles, CA	X	—	—	X	—	—	X
Warnock Hersey Intl.-Inc., Antioch, CA	X	—	X	—	X	X	—

* Reference based on research and development data. Facility is not available for conducting routine rating tests.

Note 1: See ss. ILHR 51.25 (47) to (50), (52) to (53) and (55) for test information and specific standards adopted.

Note 2: Other testing laboratories may be recognized as approved laboratories if accepted in writing by the department.

History: Cr. Register, February, 1971, No. 182, eff. 7-1-71; r. eff. 8-1-71, and recr. eff. 1-1-72, Register, July, 1971, No. 187; am. Register, December, 1977, No. 264, eff. 1-1-78; am. table, Register, December, 1978, No. 276, eff. 1-1-79; r. and recr., Register, December, 1981, No. 312, eff. 1-1-82; r. and recr. table, Register, December, 1983, No. #36, eff. 1-1-84; r. and recr. table, Register, August, 1985, No. 356 eff. 1-1-86.

ILHR 51.045 Typical examples of fire-resistive structural components.

(1) Basic design and construction for specified fire-resistive protection of structural components listed in table 2, including references (a) through (q), shall be acceptable.

Note: The following table is based on performance, interpretation of various test data or data from ASTM E-119 test (see table 2).

(a) Types of concrete. 1. Type I—normal weight concrete with limestone, calcareous gravel and air-cooled slag aggregate.

2. Type II—normal weight concrete with siliceous gravel, granite or quartz aggregate containing more than 40% quartz, chert or flint. Values given for type I apply except where values are tabulated for type II.

TYPICAL EXAMPLES OF FIRE RESISTIVE STRUCTURAL COMPONENTS, TABLE 2

TYPE OF CONSTRUCTION	ROW NO.	STRUCTURAL COMPONENTS	SKETCHES	INSULATING MATERIAL	DESCRIPTION	MINIMUM REQUIREMENTS												
						4 HR.			3 HR.			2 HR.			1 HR.			
						I	II	III	I	II	III	I	II	III	I	II	III	
CONCRETE CAST IN PLACE AND PRECAST MILD STEEL REINF.	1.	COLUMNS		CONCRETE TYPE I, II & III (a)(b)	REINF. COVER MIN. DIM. and AREA-SQ. IN.	2	2	2	2	2	2	1-1/2	1-1/2	1-1/2	1-1/2	1-1/2	1-1/2	
	2.	GIRDERS AND BEAMS		CONCRETE TYPE I, II & III (a)(b)(d)	REINF. COVER WIDTH (w)	2	2	2	1-1/2	1-1/2	1-1/2	1-1/2	1-1/2	1-1/2	1	1	1	
	3.	JOISTS & WAFFLES WITHOUT FILLERS OR PARTIAL FILLERS OF MASONRY OR CLAY TILE		CONCRETE TYPE I, II & III (a)(b)(c)(d)(e)(h)(n)	REINF. COVER WIDTH WEB (w) TH. TOP SLAB (t)	1	1	1	1	1	1	3/4	3/4	3/4	3/4	3/4	3/4	
	4.	SLABS OR JOISTS & WAFFLES WITH MASONRY OR CLAY TILE FILLER		CONCRETE TYPE I, II & III (a)(b)(c)(d)(e)(h)(n)	REINF. COVER TOP SLAB (t)	1	1	1	1	1	1	3/4	3/4	3/4	3/4	3/4	3/4	
	5.	WALLS AND PARTITIONS BEARING AND NONBEARING		CONCRETE TYPE I, II & III (a)(b)(c)	REINF. COVER THICKNESS (t)	1	1	1	1	1	1	3/4	3/4	3/4	3/4	3/4	3/4	
CONCRETE PRECAST & CAST IN PLACE POST-TENSIONED OR PRE-TENSIONED SIMPLE SPAN	6.	GIRDERS AND BEAMS		CONCRETE TYPE I, II & III (a)(b)(k)	AVE. COVER (w)	I & II 3-1/2	III 3	I & II 9-1/2	III 3	I & II 2-3/4	III 2-1/2	I & II 2	III 2	I & II 1-3/4	III 1-3/4	I & II 4	III 4	
	7.	JOISTS AND WAFFLES		CONCRETE TYPE I, II & III (a)(b)(c)(d)(e)(k)	AVE. COVER AVE. WEB TH. (w) SLAB TH. (t)	3-1/2 11	3 10	3 9-1/2	2-3/4 8	2-1/2 7	2 6-1/4	1-3/4 4	1-3/4 4	1-3/4 4	1-1/2 4	1-1/2 4		
	8.	SINGLE TEE		CONCRETE TYPE I, II & III (a)(b)(c)(d)(e)(k)	AVE. COVER AVE. WEB TH. (w) TOP THICK'S (t)	2-3/4 8	2-3/4 8	1-3/4 8	1-3/4 8	1-3/4 8	1-3/4 8	1-3/4 8	1-3/4 8	1-3/4 8	1-3/4 8	1-3/4 8		
	9.	MULTI-TEE UNITS		CONCRETE TYPE I, II & III (a)(b)(c)(d)(e)(k)	AVE. COVER AVE. WEB TH (w) TOP THICK'S (t)	2-3/4 8	2-3/4 8	1-3/4 8	1-3/4 8	1-3/4 8	1-3/4 8	1-3/4 8	1-3/4 8	1-3/4 8	1-3/4 8	1-3/4 8		
	10.	SOLID & CORDED SLABS		CONCRETE TYPE I, II & III (a)(b)(c)(d)(e)(h)(k)	t ₁ OR t ₂ AVE. COVER	6-3/4 2-1/2	7 2-1/4	5-1/2 2	5-3/4 2	6 1-3/4	4 1-3/4	4-3/4 1-3/4	5 1-1/2	3-3/4 1-1/2	3-1/4 1	3-1/2 1		
	MASONRY BEARING AND NON BEARING	11.	UNREINFORCED CONCRETE WALLS & PARTITIONS		CONCRETE TYPE I, II & III (a)(m)	WALL TH. (t)	6	6-1/2	5	5	5-1/2	4-1/2	4	4-1/2	4	3	3	3
		12.	HOLLOW MASONRY WALLS & PARTITIONS...BLOCK TILE, CORED BRICKS, CAVITY WALLS		COARSE AGGREGATE (q)(n)	EQUIV. THICK' (t)	4.7		4.0		3.2		2.1					
					EXPANDED SLAG	EQUIV. THICK' (t)	5.1		4.4		3.6		2.6					
					EXPANDED CLAY, SHALE OR SLATE	EQUIV. THICK' (t)	5.9		5.0		4.0		2.7					
	13.	SOLID MASONRY BRICK BLOCK...CLAY TILE WITH LESS THAN 25% VOIDS OR WITH THE CORES FILLED		MASONRY CLAY, SHALE, CONCRETE, SAND OR LIME (o)	WALL TH. (t)	10"		8"		6"		4"						
COMPONENTS WITH DIRECT APPLIED PROTECTION STEEL	14.	COLUMNS		CONCRETE TYPE I, II & III (a)(p)	THICKNESS OF PROTECTION	I 2	II 2-1/2	III 1-1/2	I 2	II 3-3/4	III 3-3/4	I 2-1/4	II 2-1/4	III 2-1/4	I 2-1/4	II 2-1/4	III 2-1/4	
	15.	GIRDERS...BEAMS...TRUSSES		CONCRETE TYPE I, II & III (a)(p)	THICKNESS OF PROTECTION	I 2	II 2-1/2	III 1-1/2	I 2	II 1-1/2	III 1	I 1-1/2	II 1-1/2	III 1	I 1	II 1	III 1	
	16.	COLUMNS...BEAMS...GIRDERS... TRUSSES...JOISTS & STEEL FLOOR UNITS		SPRAYED FIBER...CEMENTITIOUS MIXTURE...INTUMESCENT PAINTS		BY TESTS...OR LISTING BY APPROVED TESTING LABORATORY												

TYPICAL EXAMPLES OF FIRE RESISTIVE STRUCTURAL COMPONENTS, TABLE 1 (CONT'D.)

TYPE OF CONSTRUCTION	ROW NO.	STRUCTURAL COMPONENTS	SKETCHES	INSULATING MATERIAL	DESCRIPTION	MINIMUM REQUIREMENTS					
						1 HP.	3 HP.	2 HR.	1 HR.		
COMPONENTS WITH SUSPENDED OR ATTACHED PROTECTION	CONC.	17.	Concrete Joists or Waffle		a c 4 Concrete Type I, II or III 1/4" cover Vermiculite...gypsum...or perlite gypsum on metal lath	t _R Slab Thickness t _I Insulation Thickness	3"	3"			
		STEEL FRAMING	18.	Steel Columns		Type I & II Masonry of 1-1/2" air space	t Insulation Thickness	4" solid			
	19.		Steel Girders...Beams... Trusses...Joists, Columns Individually Protected		Sprayed Fibre...Cementitious Mixture...Lath & Plaster					By Tests . . . or Listing By Approved Testing Lab	
	20.		Steel Beams, Girders, Trusses & Joists...w/Ceiling Protection of Minimum 2-1/2" Th. Type I, II or III Concrete Slab a c 1		Sprayed Fibre...Cementitious Mixture...Lath & Plaster Acoustical Tile					By Tests . . . or Listing By Approved Testing Lab	
	21.		Steel Stud Partition Nonbearing, Min. 2-1/2" Stud		Gypsum...Perlite Plaster on Perforated Gyp. Lath Gypsum Wall Board q	t _P Plaster t _L Lath No. Layers Thick, Each			3/4"-3/8"	1/2"-3/8"	
	CONCRETE CONSTRUCTION	22.	Wood Joists Min. 2" x 10", Wood Floor Attached Ceiling q		Gypsum Wallbrd Below 2" x 10"s Max. 24" o/c 1/2" Plywood or 1" x 6" T & C Sub-Plg	t _J Wallbrd Thickness t _F Flooring					5/8" 5/8" Plywood or Nom. 1" x 3" T&C
		23.	Wood Joists Min. 2" x 10", Wood Floor Suspended Ceiling		Noncombustible Acoustical Tile Below 2" x 10"s 16" o/c 5/8" Plywood or Nom. 1" x 4" T&C Sub-Plg	t _I Insulation t _F Flooring					5/8" 1/2" Plyd or Nom. 1"x6" T&C
		24.	Wood Stud Partition Min. 2" x 4" Stud		Gypsum Wallboard q	No. Layers / Th. of Each			Two 5/8"	Two 3/8" or One 5/8"	
					Gypsum Perlite Plaster On 3/8" Gypsum Lath Gypsum & Sand Plaster on U.L. Listed Wire Lath Gypsum & Vermiculite Plaster on Metal Lath	t _P t _L t _C			1" plas. w/1" hex. mash	3/16" plaster 3/4" plaster 3/4" plaster	
	HEAVY TIMBER CONSTRUCTION TABLE										
HEAVY TIMBER SOLID OR LAMINATED	25.	Columns		Wood All Species	Floor...Width X Depth Min. Nom. Roof...Width X Depth Min. Nom.					8" x 8" 6" x 8"	
	26.	Girders & Beams		Wood All Species	Min. Width X Depth (Nom.)					6" x 10"	
	27.	Arch & Truss for Roof Only		Wood All Species	Min. Width X Depth Each Member						4" x 6"
	28.	Floor & Roof Deck		Wood All Species	Roof Floor						2" Nom. T&G or 3" Solid 3" Nom. T&G or 4" Solid

3. Type III—lightweight aggregate with expanded slag, shale or clay aggregate. Includes sanded—lightweight concretes not over 115 lbs. per cu. ft. oven-dried density.

(b) Cover on reinforcing steel is for sides and bottoms. Where tensile reinforcing elements have different cover, the tabulated cover is the average of the minimum values of the individual elements. The cover of an individual element shall not be less than ½ the tabulated value. Top cover to be a minimum of ¾ inch.

(c) For the heat transmission requirements of floor and roof construction, the thickness of the top slab may be reduced if noncombustible insulation is directly applied to either side of the slab and provided the U-factor is equaled or reduced.

(d) The thickness of top slab is in accordance with ASTM E-119 heat transmission requirements. For variations in thickness of top slab see s. ILHR 51.042 (5).

Note: For ASTM E-119 standard adopted see Ind 51.25 (49).

(e) Longitudinal joints between individual precast floor or roof units, or individual wall units shall be installed as tested or shall be grouted solid for the thickness required by the fire-resistive rating. Noncombustible insulation may be substituted for the grout if the U-factor is equaled or reduced providing the integrity of insulation remains as installed. The topping used in floor or roof units may be included.

(g) Equivalent thickness = $\frac{\text{Total volume minus volume of voids}}{\text{length times height}}$

(h) t_2 -equivalent thickness = $\frac{\text{Total conc. area minus area of void}}{\text{width}}$

(i) Clay, shale, concrete or sand lime—with less than 25% voids or with all spaces filled.

(j) 1½ inch space between column and masonry unit—no fill required.

(k) For restrained conditions, thickness of fire protection may be reduced if substantiated by test data or calculation method.

(l) Elements with this minimum size are recognized for heavy timber construction, acceptable for certain buildings in lieu of one hour noncombustible construction.

(m) Where combustible members are framed into a wall, the wall shall be of such thickness or be so constructed that the fire barrier between the member and the opposite face of the wall, or between adjacent members set in from opposite sides will be 93% of the equivalent thickness shown in Table 2.

(n) Cover thickness on reinforcing steel as indicated is based on continuity of system. For simple span conditions increase cover thickness by 50%.

(p) Wire mesh reinforced and with a minimum area of 0.015 inches square per foot of length or equivalent.

(q) 5/8 gypsum wallboard shall be type "X" or "C".

(r) The specified hourly rating may be increased by 2 hours if the cores are filled with loose, dry expanded slag, water repellent vermiculite or burned clay or shale.

History: Cr. Register, February, 1971, No. 182, eff. 7-1-71; r. eff. 8-1-71, and recr. eff. 1-1-72, Register, July, 1971, No. 187; am. (1) (f), Register, March, 1972, No. 195, eff. 4-1-72; am. (1) (intro.) and (q), Register, December, 1981, No. 312, eff. 1-1-82; r. and recr. table 2, line 12, r. (1) (f) cr. (1) (r), Register, December, 1983, No. 336, eff. 1-1-84.

ILHR 51.046 Calculation method. (1) The rational design of structural members for fire resistance shall be submitted to the department and shall be based on the type of span (simple or restrained), the magnitude of longitudinal restraint, accepted structural engineering principles and methods.

(a) Appropriate research data and design criteria to substantiate the method, interpreting between known information, shall accompany the above material and shall include:

1. Time—temperature relationship ASTM E-119.
2. The temperature—strength characteristics of the structural components.
3. The time—temperature characteristics of the insulating material, at temperature range designated by ASTM E-119.
4. The expansion characteristics of the materials comprising the member, at the temperature range designated by ASTM E-119.

Note: For ASTM E-119 standard adopted see s. ILHR 51.25 (49). 2. The department will accept published research data from Portland Cement Association, American Iron & Steel Institute, and American Institute of Steel Construction, Inc.

5. The safety factor of not less than 1.0 shall be maintained at the end of the time requirement for the full design live and dead load.

History: Cr. Register, February, 1971, No. 182, eff. 7-1-71; r. eff. 8-1-71, and recr. eff. 1-1-72, Register, July, 1971, No. 187.

ILHR 51.047 Fire-rated door assemblies in fire-rated construction. (1) **FIRE-RATED DOOR ASSEMBLIES.** Door openings, where permitted in fire-rated walls, shall be protected with fire-rated door assemblies as specified in Table 51.047. Fire-rated door assemblies shall be tested in accordance with ASTM E-152.

FP

TABLE 51.047

Fire-resistive Rating of Wall (in hours)	Minimum Fire-resistive Rating of Required Fire Door Assembly (in hours)
4-hour	3-hour
3-hour	3-hour
2-hour	1½-hour
1-hour	¾-hour
¾-hour	¾-hour
see occupancy chs. ILHR 54-62	½-hour (20 min.)

(a) *Exception.* Doors leading to fire escapes, except doors leading to Class A fire escapes in apartments and row houses, shall be at least ¾-hour fire-rated door assemblies.

(b) Where the occupancy chapters of this code permit, 20-minute fire-rated door assemblies, or equivalent, may be provided, without a closing device.

(2) LABELS. Fire-rated door assemblies shall be labeled with a permanent label, securely attached and located to permit visual inspection after installation. The label shall identify the time rating, testing laboratory, listing agency and manufacturer.

(a) Labeled fire-door assemblies shall not be modified without written acceptance from the testing laboratory.

(3) INSTALLATION OF FIRE-RATED DOORS. The fire-rated door assemblies shall be installed with frame, hinges, latches, closing devices and counterweights in accordance with methods and standards approved by the department. Adequate clearance shall be maintained to permit free operation of fire-rated doors.

Note 1: The department will accept recommended practices for installation covered in "Standard for Fire Doors and Windows," NFPA No. 80.

Note 2: See s. ILHR 51.15 for exit door requirements.

(4) SECURING DOOR FRAMES. Methods of securing door frames to adjacent construction shall be illustrated on the plans submitted to the department for review.

(5) DOOR CLEARANCES. The maximum swinging-door clearances to frame shall be $\frac{1}{8}$ inch on sides and top and $\frac{3}{4}$ inch at bottom between sill or floor.

FP (6) DOOR CLOSING DEVICES. All labeled fire-rated doors, where required, shall be equipped with an approved automatic or self-closing device as defined in s. ILHR 51.01 (17).

(a) All doors serving smokeproof towers or interior enclosed stairways shall be equipped with a self-closing device or an automatic closing device actuated by products of combustion other than heat.

(b) The requirements of sub. (6) (a) shall also be retroactive to existing buildings.

(c) Doors provided with a self-closing device shall remain in a closed position.

Note: The intent of this rule is to accept normal usage of the door, but not permit doors with this closing device to be blocked open at any time.

(d) Where a pilot weight is used, it shall be suspended from a chain or wire cable, and shall be installed in a protective housing.

Note: For specific types of closing devices permitted, please refer to the sections dealing with classes of construction and/or the occupancy chapters.

History: Cr. Register, February, 1971, No. 182, eff. 7-1-71; r. eff. 8-1-71 and recr. eff. 1-1-72, Register, July, 1971, No. 187; am. (1) (intro.), r. and recr. (1) (a) 1., Register, September, 1973, No. 213, eff. 10-1-73; cr. (1) (a) 1. e., Register, December, 1974, No. 228, eff. 1-1-75; r. and recr., Register, December, 1975, No. 240, eff. 1-1-76; r. and recr. (6), Register, December, 1976, No. 252, eff. 1-1-77; cr. (2) (a), Register, January, 1980, No. 289, eff. 2-1-80; am. (1), Register, December, 1981, No. 312, eff. 1-1-82; am. (6) (a), Register, December, 1983, No. 336, eff. 1-1-84.

ILHR 51.048 Fire window and glass block assemblies in fire-rated construction. (1) WINDOW OPENINGS. Window openings, where permitted in Register, August, 1985, No. 356

fire-rated walls, shall be protected with fire window or glass block assemblies rated as ¾-hour by an approved laboratory and tested in accordance with ASTM E-163 standard method [ILHR 51.25 (53)].

(2) **SIZE.** (a) *Fire window assemblies.* The size of the wired glass and frame assembly shall not exceed the size tested. Windows combined in multiple assemblies shall be separated by approved nonbearing metal mullions.

Note: Fire windows have been classified for either moderate or light fire exposure. For moderate fire exposure, the individual glass size is limited to 720 square inches. (Size limitation either 48 inches maximum width or 54 inches maximum height.) For light fire exposure, the individual glass size is limited to 1,296 square inches. (Size limitations either 54 inches maximum width or 54 inches maximum height.) Please refer to sections for classes of construction and/or occupancy chapters for fire window classifications.

(b) *Glass block assemblies.* Openings for glass block assemblies shall not exceed 120 square feet in area. The width or height of the opening shall not exceed 12 feet.

Note: Openings for glass block assemblies are classified for light fire exposure.

(3) **MATERIALS AND INSTALLATION.** (a) *Frames.* Approved metal frames shall be securely fastened to the construction and be capable of resisting all wind stresses and other stresses to which they are likely to be subjected.

(b) *Wired glass.* The wired glass shall be labeled wired glass, ¼-inch thick, and shall be well bedded in approved glazing compound. All exposed joints between the metal shall be struck and pointed. The clearance between the edges of the glass and metal framing shall not exceed ¼ inch.

(c) *Glass block.* Glass block assemblies shall be installed according to the details of the tested assembly.

Note: The department will accept recommended practices for installation covered in "Standard for Fire Doors and Windows," NFPA No. 80.

(4) **LABELS.** Fire window assemblies shall be labeled with a permanent label, securely attached and located to permit visual inspection after installation. The label shall identify the time rating, testing laboratory, listing agency and manufacturer. Glass block shall be listed by an approved laboratory.

History: Cr. Register, December, 1975, No. 240, eff. 1-1-76.

ILHR 51.049 Miscellaneous openings in fire-rated construction. (1) **SERVICE OPENINGS.** Openings around ducts, pipes, conduit or other service installations penetrating required fire-resistive rated floor, wall and roof assemblies shall be filled solidly with material of fire-resistive rating equal to the required rating of assembly penetrated.

(2) **FIRE DAMPERS.** Duct openings in required fire-resistive rated floor and wall assemblies shall be protected as specified under s. ILHR 64.42.

(3) **PLASTIC PLUMBING AND ELECTRICAL SYSTEM COMPONENTS.** Penetration of required fire-resistive rated floor, wall, ceiling and roof assemblies by plastic plumbing and electrical system components shall be in accordance with one of the following:

(a) A device or system tested and listed by an approved testing laboratory;

(b) For plastic plumbing pipes, substitute a steel or cast iron pipe where it penetrates the fire-rated assembly and extend it for a distance of at least 10 inches beyond both faces of the assembly;

(c) Provide a 10-gauge steel sleeve one inch larger in diameter than the plastic plumbing pipe or electrical wiring and extending 10 inches beyond both faces of the assembly. The annular space between the plastic component and protective sleeve shall be packed with an inorganic filler; or

(d) Wrap the plastic component for a distance of at least 3 feet from both faces of the fire-rated assembly with at least one inch of inorganic insulating material. The inorganic insulation material shall be mechanically attached to the plastic component.

History: Cr. Register, December, 1975, No. 240, eff. 1-1-76; cr. (3), Register, January, 1980, No. 289, eff. 2-1-80; am. (3) (intro.), Register, December, 1981, No. 312, eff. 1-1-82.

ILHR 51.05 Roof coverings. Roof coverings of class A, B, C or unclassified shall be provided as specified under "Classes of Construction" or under the specific occupancy requirements.

Note: Brick, concrete, tile, slate, ferrous and cupreous metals and their alloys will be accepted as "Class A" roof coverings.

History: Cr. Register, February, 1971, No. 182, eff. 7-1-71; r. eff. 8-1-71, and recr. eff. 1-1-72, Register, July, 1971, No. 187; renum. from 51.048 to be 51.050, Register, December, 1975, No. 240, eff. 1-1-76.

ILHR 51.06 Foam plastics. (1) **SCOPE.** The requirements of this section shall apply to the use of foam plastics in building construction.

(2) **FLAME SPREAD AND SMOKE DEVELOPED CRITERIA.** Except as otherwise provided, all foam plastic and foam plastic cores in manufactured assemblies used in building construction, shall have a flame spread rating of not more than 75 and a smoke developed rating of not more than 450 when tested in the maximum thickness intended for use in accordance with ASTM E84.

FP (3) **THERMAL BARRIER.** (a) Except as provided in subs. (4) to (7), foam plastics shall be separated from the interior of a building by an approved thermal barrier of ½ inch gypsum wallboard or equivalent thermal barrier material which will limit the average temperature rise of its unexposed surface to not more than 250°F. after 15 minutes of fire exposure as specified in the ASTM E119 standard time temperature curve or the equivalent using the Small Scale Horizontal Exposure Furnace, with samples for the test having a minimum length and width of 3 feet by 3 feet.

(b) The thermal barrier shall be installed in such a manner that it will remain in place for at least 15 minutes based upon approved diversified tests.

(4) **EXTERIOR APPLICATIONS.** The following requirements shall apply to all exterior uses of foam plastics unless specifically approved as specified in sub. (7):

(a) *Masonry or concrete components.* Foam plastics may be used without the thermal barrier specified in sub. (3) regardless of the class of construction, when the foam plastic is protected by a minimum of one inch thickness of masonry or concrete in a wall or floor system;

(b) *Noncombustible hourly rated and combustible hourly rated construction.* Foam plastics may be used within the cavity or as an element of a noncombustible hourly rated or combustible hourly rated system or assembly provided:

1. The system or assembly meets the requirements of a s. ILHR 51.04 for time-rated construction;

2. a. Except as provided in subpar. b., a thermal barrier as specified in sub. (3) is provided;

b. The thermal barrier may be omitted for exterior walls provided that the foam plastic insulation does not exceed 4 inches in thickness, has a flame spread rating of 25 or less, and is covered by a thickness of not less than 0.032 inch aluminum or corrosion-resistant sheet steel having a base metal thickness of 0.016 inches and the wall height does not exceed 50 feet and the entire building or that portion of the building closed by the walls is protected with an automatic fire sprinkler system; and

3. a. Except as provided in subpar. b., the exterior side of the assembly or system is covered with a cladding material meeting the requirements for noncombustible construction, and the wall assembly shall not propagate flame over the surface or through the core when subjected to a full scale test with the assembly in its end use condition or when subjected to an approved diversified test;

b. The exterior coating, facing or cladding material for walls may be of other than noncombustible material provided that the foam plastic core, coating, facing and cladding, each when tested individually shall have a flame spread of 25 or less and a smoke developed rating of 450 or less when tested in accordance with ASTM E84; facing, coating, cladding and core material shall be fastened to each other to prohibit failure in bond as a result of temperature which may be experienced in a building fire, or from winds or other conditions; and the wall assembly shall not propagate flame over the surface or through the core when subjected to a full scale test with the assembly in its end use condition or when subjected to an approved diversified test.

(c) *Noncombustible 0-hour (NC-0) rated construction.* Foam plastics may be used within the cavity or as an element of noncombustible 0-hour (NC-0) rated construction provided the following conditions are satisfied:

1. The foam plastic core material has a flame spread of 25 or less and a smoke developed rating of 450 or less when tested in accordance with ASTM E 84;

2. a. Except as provided in subpar. b., a thermal barrier as specified in sub. (3) is provided;

b. The thermal barrier may be omitted for exterior walls provided that the foam plastic insulation does not exceed 4 inches in thickness, and is covered by a thickness of not less than 0.032 inch aluminum or corrosion-resistant sheet steel having a base metal thickness of 0.016 inches and the wall height does not exceed 50 feet and the entire building or that portion of the building enclosed by the walls is protected with an automatic fire sprinkler system; and

3. a. The exterior side of the assembly or system is covered with a cladding material meeting the requirements for noncombustible construction as specified in s. ILHR 51.01 (86);

b. The exterior coating, facing or cladding material for walls may be of other than noncombustible material provided that the coating, facing and cladding, shall have a flame spread of 25 or less and a smoke developed rating of 450 or less when tested in accordance with ASTM E 84;

c. The facing, coating, cladding and core material shall be fastened to each other to prohibit failure in bond as a result of temperature which may be experienced in a building fire, or from winds or other conditions; and

d. The wall assembly shall not propagate flame over the surface or through the core when subjected to a full scale test with the assembly in its end use condition or when subjected to an approved diversified test.

Note: Light-transmitting plastic veneer or combustible veneer materials conforming to the requirements of this paragraph need not meet the height and area limitations for light-transmitting plastics (see s. ILHR 51.065).

(d) *Combustible nonrated construction.* Foam plastic insulation may be used within the cavity or as an element of combustible nonrated construction (0) provided the following conditions are satisfied:

1. The distance to a property line or other building on the same property meets the requirements of Table 51.03-A;

2. Thermal barriers as specified in sub. (3) are provided; and

3. The exterior side of the assembly or system is covered with a cladding material meeting the requirements for combustible construction as specified in Table 51.03-A.

(e) *Roofing.* Foam plastic may be used as part of a class A, B or C or unclassified roof covering as specified in s. ILHR 51.05. The foam plastic:

1. Shall not be limited as to smoke development rating;

2. Shall not be limited as to flame spread rating if it is a component of a factory-made composite insulation or assembly and the roof system complies with the calorimeter requirements of FM 4450, Approval Standard for Class I Insulated Steel Roof Decks, or UL 1256, Outline of Investigation for Roof Deck Construction;

3. May be installed without a protective thermal barrier if the foam plastic has a flame spread rating of 75 or less when tested at the maximum thickness intended for use and the roof system complies with the calorimeter requirements of FM 4450, Approval Standard for Class I Insulated Steel Roof Decks, or UL 1256, Outline of Investigation for Roof Deck Construction; and

4. May be installed without a protective thermal barrier if the foam plastic has a flame spread rating of 75 or less when tested at the maximum thickness intended for use and the foam plastic is separated from the building interior by a minimum of one inch thickness of masonry or concrete or a minimum of ½ inch thickness plywood bonded with exterior glue and properly edge supported, or equivalent.

(5) OTHER APPLICATIONS. (a) *Interior construction.* Foam plastic may be used as an element of or attached to interior construction components, including walls, partitions, floor/ceiling assemblies and similar components that divide interior spaces within the building, as follows:

1. Within the cavity or as an element of a noncombustible hourly rated or combustible hourly rated system or assembly provided the system or assembly meets the requirements of s. ILHR 51.04 for time-rated construction for at least one hour with a fire exposure on both sides of the system or assembly; or

2. Within the cavity or as an element of noncombustible 0-hour (NC-0) rated construction or combustible nonrated construction (0) provided the foam plastic is protected on both sides by a thermal barrier as specified in sub. (3).

(b) *Attics and crawl spaces.* 1. Attics may be insulated with unprotected foam plastic provided the ceiling between the attic and the occupied space is covered by ½ inch gypsum wallboard or equivalent and the attic space is not used for storage or air handling purposes.

2. Crawl space walls may be insulated with unprotected foam plastic provided the floor between the crawl space and the occupied space consists of at least ¾ inch tongue and groove plywood sheathing or equivalent, and the crawl space is not used for storage or air handling purposes.

3. Foam plastic shall be protected by a thermal barrier as specified in sub. (4) when the foam plastic is installed in an attic or crawl space and the area is used for storage or air handling purposes.

(c) *Doors and shutters.* 1. a. Except as provided in subpar. b., where doors and shutters are permitted without a fire-resistive rating, foam plastic having a flame spread rating of 75 or less may be used as a core material when the facing is metal having a minimum thickness of 0.032 inch aluminum or sheet steel having a minimum thickness of 0.0160 inch.

b. Foam plastic core sectional overhead doors covered by at least ¾ inch thick hardboard may be used wherever nonrated combustible doors are permitted.

2. A thermal barrier is not required for doors and shutters meeting the requirements specified in subd. 1.

(d) *Siding backer board.* Foam plastic not more than ½ inch thick may be used as siding backer board provided it is separated from the interior of the building by not less than 2 inches of mineral fiber insulation or equivalent in lieu of the thermal barrier or when applied as insulation when residing over existing wall construction.

(e) *Decorative trim.* Foam plastic used as decorative trim shall conform with the provisions of s. ILHR 51.07.

(f) *Protection from ultraviolet light.* Foam plastic insulation installed on the exterior of buildings above grade shall be permanently covered or protected to prevent degradation caused by exposure to ultraviolet light.

(6) SPECIFIC APPLICATIONS. (a) *Refrigerated facilities.* 1. Except as provided in subd. 2., foam plastic installed and meeting the requirements of sub. (2) when tested in a thickness of 4 inches may be used in thicknesses up to 10 inches in cold storage rooms, refrigerated food processing rooms,

ice plants and similar areas. The foam plastic for refrigerated rooms within a building shall be protected on both sides by a thermal barrier as specified in sub. (3).

2. Except as provided in subd. 3., foam plastic insulation may be used without the thermal barrier when the foam plastic has a flame spread rating of 25 or less when tested as specified in subd. 1., is covered by not less than 0.032 inch of aluminum or corrosion-resistant steel having a base metal thickness not less than 0.016 inch at any point and is protected by an automatic fire sprinkler system. When a cooler or freezer module is located within a building, both the cooler or freezer module and that part of the building in which the module is located shall be protected by an automatic fire sprinkler system.

3. a. Foam plastics may be used in a thickness up to 4 inches in free-standing coolers or freezers having an aggregate floor area less than 400 square feet without a thermal barrier and without an automatic fire sprinkler system; or

b. Freezer warehouses may be constructed without automatic fire sprinkler system protection provided the freezer warehouse is equipped with a complete approved smoke detection system throughout and the system is connected to a constantly attended station; the freezer warehouse is separated from all other use areas of the building (i.e., offices, loading docks, nonrefrigerated storage, mechanical rooms) by at least 2-hour fire-resistive rated construction; the freezer warehouse is located to provide at least a 30 foot separation to any property line or other building on the same property; and the foam plastic material complies with the provisions of sub. (7).

Note: See s. ILHR 52.015 for additional rules pertaining to automatic fire sprinkler systems.

(b) *Bulk vegetable storage.* Buildings used exclusively for the bulk storage of vegetables shall have the foam plastic insulation protected on the occupied side by $\frac{3}{8}$ inch exterior grade plywood, or equivalent.

(7) **SPECIFIC MATERIALS APPROVAL.** Foam plastic not meeting the requirements of this section may be approved by the department for specific application based on the submittal and written acceptance of data from approved diversified tests.

Note: See s. ILHR 50.19 for additional information pertaining to product approval.

History: Cr. Register, May, 1979, No. 281, eff. 6-1-79; cr. (3) (b) 8. a., Register, May, 1980, No. 293, eff. 6-1-80; cr. (3) (b) 11., Register, December, 1981, No. 312, eff. 1-1-82; r. and recr. Register, December, 1983, No. 336, eff. 1-1-84; am. (2), (3) (a), (4) (b) 3.b., (4) (c) 1. and 3.b. and (4) (e) 2. and 3., Register, August, 1985, No. 356, eff. 1-1-86.

ILHR 51.065 Light-transmitting plastics. (1) **SCOPE.** (a) The requirements of this section shall apply to the quality and methods of application of plastics for use as light-transmitting materials in buildings and structures. When used as interior finish, plastic materials shall meet the requirements of s. ILHR 51.07.

(b) 1. Approved light-transmitting plastic shall meet one of the following combustibility classifications:

a. CC 1 — Plastic materials which have a burning extent of one inch per minute or less when tested in nominal .060 inch thickness or in the thickness intended for use by ASTM D 635, Test for Flammability of Self-Supporting Plastics; or

Register, August, 1985, No. 356

b. CC 2 — Plastic materials which have a burning rate of 2.5 inches per minute or less when tested in nominal .060 inch thickness or in the thickness intended for use by ASTM D 635, Test for Flammability of Self-Supporting Plastics.

2. Light-transmitting plastic materials may be of any class as defined by this section. Before any light-transmitting plastic material may be approved for use, the manufacturer shall file with the department technical data which relates to the proposed use of the material. The data shall include the pertinent physical, mechanical and thermal properties, such as but not limited to weather resistance, expansion coefficient and combustibility characteristics. The department shall determine the adequacy of the data. Where the department determines that the material is satisfactory for the intended use, approval of the material shall be granted subject to the limitations specified in this section.

Note: See s. ILHR 50.19 for additional information.

3. The department shall review and make a determination on an application for approval of light-transmitting plastic material within 30 business days of receipt of all technical data required to complete the review.

(c) All light-transmitting plastic materials approved for use under this section or s. ILHR 50.19 shall be identified by the trade formula, number or name.

(2) DEFINITIONS. For the purpose of this section, the following definitions shall apply.

(a) "Approved light-transmitting plastic" means a single layer or multi-layer composite consisting of thermoplastic, thermosetting or reinforced plastic material which has a self-ignition temperature 650° F. or greater when tested in accordance with Standard Method of Test for Ignition Properties of Plastics, ASTM D 1929, a smoke density rating no greater than 450 when tested in accordance with Standard Method of Test for Surface Burning Characteristics of Building Materials, ASTM E 84 in the way intended for use, or a smoke density rating no greater than 75 when tested in the thickness intended for use by Standard Method for Measuring the Density of Smoke from the Burning or Decomposition of Plastics, ASTM D 2843. Multi-layer composite material shall comply as a composite in the configuration intended for use.

(b) "Glass fiber reinforced plastic" means plastic reinforced with glass fiber having not less than 20% of glass fibers by weight.

(c) "Interior secondary glazing system" means construction consisting of a glazed panel of approved light-transmitting plastic positioned on the interior side of a primary window set in an exterior wall which is designed primarily to control energy losses through exterior windows or glazed panels and is not intended for use as primary or exterior windows.

(d) "Light diffusing system" means a suspended construction consisting in whole or in part of lenses, panels, grids or baffles suspended below independently mounted electrical lighting sources.

(e) "Plastic glazing" means single glazing plastic materials which are glazed or set in a frame or sash and not held by mechanical fasteners which pass through the glazing material.

(f) "Plastic roof panels" means single glazing plastic materials which are fastened to structural members or to structural panels or sheathing and which are used as light-transmitting media in the plane of the roof.

(g) "Plastic wall panels" means single glazing plastic materials which are fastened to structural members or to structural panels or sheathing and which are used as light-transmitting media in exterior walls.

(h) "Thermoplastic material" means a plastic material which is capable of being repeatedly softened by increase of temperature and hardened by decrease of temperature.

(i) "Thermosetting material" means a plastic material which is capable of being changed into a substantially non-reformable product when cured.

(3) **GLAZING OF UNPROTECTED OPENINGS.** (a) *General.* Doors, sash and openings which are not required to be protected with fire window or glass block assemblies may be glazed with approved light-transmitting plastic in the following occupancies:

Note: See Table 51.03-B for additional requirements pertaining to windows and wall openings.

1. Schools and Other Places of Instruction under ch. ILHR 56;
2. Residential Occupancies under ch. ILHR 57; and
3. All other occupancies under chs. ILHR 54, 55, 58, 59, 60, 61 and 62, subject to the following requirements:

a. Except as provided in par. (b), the area of such light-transmitting plastic glazing may not exceed 25% of the wall face of the story in which it is installed;

b. Except as provided in par. (b) 2., the area of a pane of light-transmitting plastic glazing installed above the first story shall not exceed 16 square feet where the vertical dimension of a pane may not exceed 4 feet and there shall be a spandrel constructed of materials meeting the requirements for exterior walls of s. ILHR 51.03 and Table 51.03-A for the class of construction utilized between stories measuring a minimum of 3 feet in the vertical dimension;

c. Except as provided in par. (b) 2., approved light-transmitting plastics shall not be installed more than 75 feet above grade level;

d. Combinations of light-transmitting plastic glazing and light-transmitting plastic wall panels shall be subject to the area, height and percentage limitations and separation requirements applicable to the class of plastics as specified in sub. (4).

(b) *Exceptions.* 1. Approved light-transmitting plastic glazing may be installed in areas up to 50% of the wall area of each story in structures less than 75 feet in height which are provided on each floor above the first floor with fire canopies projecting at least 3 feet from the surface of the wall and extending at least 3 feet horizontally beyond the edge of the opening above, or equivalent. The size and dimension requirements specified in par. (a) 3. b. shall not apply.

2. Where an approved automatic fire sprinkler system is provided, the permissible area of light-transmitting plastic glazing permitted by par.

(a) 3. a. may be increased to a maximum of 50 percent of the wall face of the story in which the glazing is installed and shall be exempt from the requirements specified in par. (a) 3. b. and c.

(4) EXTERIOR WALL PANELS. (a) *General*. Subject to requirements specified in par. (b), approved light-transmitting plastics may be used as wall panels in exterior walls not requiring a fire-resistive rating in all occupancies except the following:

1. Theaters and Assembly Halls under ch. ILHR 55;
2. Health Care, Correctional and Detention Facilities under ch. ILHR 58; and
3. All high hazard occupancies.

(b) *Area and separation limitations*. 1. Except as provided in par. (c), area limitation and separation requirements of exterior light-transmitting plastic wall panels shall be as specified in Table 51.065-1.

2. Vertical spandrel wall separation constructed of materials meeting the requirements for exterior walls of s. ILHR 51.03 and Table 51.03-A for the class of construction utilized between stories shall be:

- a. Three feet for CC 1 plastic wall panels; or
- b. Four feet for CC 2 plastic wall panels.

TABLE 51.065-1
AREA LIMITATION AND SEPARATION
REQUIREMENTS FOR LIGHT-TRANSMITTING PLASTIC WALL PANELS *

Set-Back Distance to Property Line or Other Walls on Same Property	Class of Plastic	Maximum % Area of Exterior Walls in Plastic Panels	Maximum Single Area (Square Feet)	Minimum Separation of Panels (Feet)	
				Vertical	Horizontal
5 feet or less	—	NP	NP	—	—
5 feet or more but less than 10 feet	CC 1	10	50	8	4
	CC 2	NP	NP		
10 feet or more but less than 30 feet	CC 1	25	90	6	4
	CC 2	15	70		
Over 30 feet	CC 1	50	Not limited	3	0
	CC 2	25			

N.P. means not permitted

* The requirements of this Table do not apply to greenhouses. See ch. ILHR 62, subch. VI.

(c) *Exceptions*. 1. In structures which are provided on any floor above the first with continuous horizontal projections extending at least 36 inches from the surface of the wall in which light-transmitting plastic wall panels are installed, there need be no vertical separation at that floor except that provided by the vertical thickness of the projection.

2. Where an approved automatic fire sprinkler system is provided in the building, the maximum percent area of light-transmitting plastic panels in the exterior wall and the maximum square feet of single area given in Table 51.065-1 may be increased 100% but in no case may the area of light-transmitting plastic wall panels exceed 50% of the wall area.

(5) **ROOF PANELS.** (a) *General.* Except in chs. ILHR 55 and 58 occupancies and high hazard occupancies, approved light-transmitting plastic roof panels may be installed as follows, subject to the requirements specified in par. (b):

1. In roofs of buildings protected by an approved automatic fire sprinkler system;

2. Where the roof is not required to have a fire resistance rating; or

3. Where the light-transmitting plastic roof panels meet the requirements for roof coverings of the appropriate class of construction.

Note: See s. A62.015 for additional information regarding high hazard occupancies.

(b) *Limitations.* Except as provided in par. (c), the use of light-transmitting plastic roof panels shall be limited as follows:

1. Individual light-transmitting plastic roof panels or units shall be separated from each other by a distance of not less than 4 feet measured in a horizontal plane.

2. Where exterior wall openings are required to be protected, no light-transmitting plastic roof panels or units may be installed within 8 feet of such exterior wall.

3. Light-transmitting plastic roof panels or units shall be limited in area and the aggregate area of panels shall be limited by a percentage of the floor area of the room or space sheltered in accordance with Table 51.065-2.

TABLE 51.065-2 *

AREA LIMITATIONS FOR
LIGHT-TRANSMITTING PLASTIC ROOF PANELS AND SKYLIGHTS

Class of Plastic	Maximum Area Individual Unit or Panel (sq. ft.)	Maximum Aggregate Area (% of Floor Area)
CC 1	300	33%
CC 2	100	25

* The requirements of this table do not apply to greenhouses. See ch. ILHR 62, subch. VI.

(c) *Exceptions.* 1. One-story buildings not more than 16 feet in height and not exceeding 1200 square feet in area and not closer than 10 feet to another building are exempt from the limitations specified in par. (b).

2. Low-hazard use areas such as swimming pool shelters and similar structures, are exempt from the area limitations specified in par. (b) provided they do not exceed 5,000 square feet in projected floor area and are not closer than 10 feet to the property line or adjacent buildings.

Note: See s. A52.015 for additional information regarding low hazard occupancies.

(6) **SKYLIGHTS.** (a) *General.* Subject to the requirements of par. (b), skylight assemblies may be glazed with approved light-transmitting plastic in all but high hazard occupancies.

Note: See s. A52.015 for additional information regarding high hazard occupancies.

(b) *Limitations.* Except as provided in par. (c), the use of skylights with approved light-transmitting plastic glazing shall be limited as follows:

1. The light-transmitting plastic shall be mounted at least 4 inches above the plane of the roof on a curb construction consistent with that required for the class of construction of the building;

2. Dome-shaped skylights shall rise above the mounting flange a minimum distance equal to 10% of the maximum span of the dome but not less than 5 inches;

3. The edges of the light-transmitting plastic skylights or dome shall be protected by metal or noncombustible material;

4. Each skylight unit of CC 1 material may have a maximum of 300 square feet within the curb and each skylight unit of CC 2 material may have a maximum of 100 square feet within the curb;

5. The aggregate area of skylights may not exceed 33 $\frac{1}{3}$ % when CC 1 materials are used, and 25% when CC 2 materials are used, of the floor area of the room or space sheltered by the roof in which they are installed;

6. Skylights shall be separated from each other by a distance of not less than 4 feet measured in a horizontal plane; and

7. Where exterior wall openings are required to be fire protected, no skylight may be installed within 6 feet of such exterior wall.

8. Combinations of light-transmitting plastic roof panels and skylights shall be subject to the area and percentage limitations and separation requirements as specified in sub. (5) (b).

(c) *Exceptions.* 1. The requirements of par. (b) shall not apply, if:

a. The building on which the skylights of approved light-transmitting plastic glazing are located is not more than one story in height, is located not less than 30 feet from a property line and any other building on the property, and the room or space sheltered by the skylight is not a means of egress, a ch. ILHR 58 occupancy, or a high hazard occupancy; or

b. The approved light-transmitting plastic material meets the roof cover requirements for the appropriate class of construction.

2. Except in chs. ILHR 55 and 58 occupancies and high hazard occupancies, the requirements specified in par. (b) 4. to 6. shall not apply to skylights with approved light-transmitting plastic glazing provided:

a. The skylight serves as a fire venting system approved by a petition for variance as specified in s. ILHR 50.25; or

b. The skylight is used in a building equipped with an approved automatic fire sprinkler system.

(7) LIGHT-DIFFUSING SYSTEMS. (a) *Light diffusers.* 1. Unless protected with an approved automatic fire sprinkler system, plastic light-diffusing systems may not be installed in:

a. Theaters and assembly halls under ch. ILHR 55;

b. Health care, correctional and detention facilities under ch. ILHR 58; and

c. High hazard occupancies.

Note: See s. A52.015 for additional information regarding high hazard occupancies.

2. Plastic light-diffuser panels shall be supported directly or indirectly from ceiling or roof construction by use of noncombustible hangers.

3. No plastic light-diffusing system may be installed in areas required to be equipped with automatic sprinklers unless appropriate tests by a recognized laboratory have shown that such system does not prevent effective operation of the sprinklers or unless sprinklers are located both above and below the light-diffusing system to give effective sprinkler protection.

4. Approved plastic materials for light-diffusing systems shall comply with s. ILHR 51.07 unless the plastic panels comply with the following:

a. Fall from their mounting at an ambient temperature of at least 200° F. below the self-ignition temperature of the plastic material as measured by ASTM D 1929;

b. Remain in place at an ambient room temperature of 175° F. for a period of not less than 15 minutes; and

c. The maximum length of any single plastic panel does not exceed 10 feet and the maximum area of any single light diffuser does not exceed 30 square feet.

(b) *Electrical lighting fixtures.* Plastic light-transmitting panels and light-diffuser panels installed in approved electrical lighting fixtures shall comply with the requirements specified in par. (a) 4. a. to c.

(8) **EXTERIOR VENEER.** Approved light-transmitting plastic material may be installed as an exterior veneer for any building, provided:

(a) The plastic veneer may not be attached to any exterior wall to a height greater than 35 feet above grade;

(b) Sections of plastic veneer may not exceed 200 square feet in area; and

(c) Sections of plastic veneer shall be separated by a minimum of 4 feet vertically.

(9) **INTERIOR SECONDARY GLAZING SYSTEMS.** (a) Light-transmitting plastic materials used in interior secondary glazing systems shall comply with the requirements of s. ILHR 51.07 unless the approved plastic used in the interior secondary glazing system meets the following requirements:

1. The approved plastic used as the glazing falls from its mounting either with or without its frame or sash at an ambient temperature of at least 200° F. below the self-ignition temperature of the plastic material as measured by ASTM D 1929;

2. Interior secondary glazing system is not installed over windows required for egress unless approved tests have shown that the system does not interfere with egress from the window; and

3. The maximum length of any single plastic panel does not exceed 10 feet and the maximum area of any single panel does not exceed 30 square feet.

History: Cr. Register, December, 1983, No. 336, eff. 1-1-84; cr. (1) (b) 3., Register, January, 1985, No. 349, eff. 2-1-85; am. (1) (b) 1. a. and b., (2) (a), Table 2, (6) (c) 2. a., (7) (a) 4.a. and (9) (a) 1. Register, August, 1985, No. 356, eff. 1-1-86.

ILHR 51.07 Interior finishes. (1) SCOPE. The requirements of this section apply to the interior finishes or surfaces of a building.

Note #1: See s. ILHR 51.06 for the restrictions of foam plastics.

Note #2: Toxicity of the products of combustion is *not* included as a basis in determining the smoke developed criteria of this section. The smoke developed criteria is based solely upon the obscuration of light.

(2) **APPLICATION TO MATERIALS.** (a) Except as provided in par. (b), the classification of interior finish materials as specified in this section shall include the basic material used by itself or in combination with other materials.

(b) Subsequently applied paint or wall covering not exceeding 1/28 inch in thickness and classified 450 or less on the smoke test scale are exempt from the provisions of par. (a).

(3) **TRIM AND INCIDENTAL FINISH.** (a) Interior finish not in excess of 10% of the aggregate wall and ceiling areas of any room or space may be Class C materials in occupancies where interior finish of Class A or Class B is required.

(b) In addition to the other requirements of this section, foam plastic used as interior trim and incidental finish shall also comply with the following:

1. The minimum density is 20 pounds per cubic foot;
2. The maximum thickness of the trim is ½ inch and the maximum width is 4 inches;
3. The trim constitutes no more than 10% of the area of any wall or ceiling; and
4. The flame-spread rating does not exceed 75 when tested in accordance with ASTM E-84 and the smoke developed rating is not limited.

(4) **EXPOSED CONSTRUCTION.** (a) This section does not require the installation of interior finish, but where construction or fire protection materials are exposed in rooms or spaces used for the occupancies specified, the hazard from rate of flame spread of the exposed materials shall be not greater than that of the interior finish permitted for such occupancy or use.

(b) Exposed portions of structural members of Type No. 4-Heavy Timber Construction shall not be subject to the interior finish requirements of this section.

(5) **USE OF INTERIOR FINISHES.** Interior finish material shall be used in accordance with requirements specified in Table 51.07.

TABLE 51.07

MINIMUM INTERIOR FINISH REQUIREMENTS

Occupancy	Required Exit Enclosures ¹		Exit Access ^{1,2}		Rooms or Enclosed Spaces ^{1,2}	
	Walls & Ceilings ⁴	Floor ⁵	Walls & Ceilings ⁴	Floor ⁵	Walls & Ceilings ⁴	Floor ^{3,5}
Ch. ILHR 54 Occupancies Other than Storage and Warehouses	A	II	A or B	II	A, B or C	DOC FF-1 ⁶
Ch. ILHR 54 Storage and Warehouse Occupancies	A or B	DOC FF-1 ⁶	A or B	DOC FF-1 ⁶	A, B or C	DOC FF-1 ⁶
Ch. ILHR 55 Places of Assembly	A	I	A	II	A or B ⁷	DOC FF-1 ⁶
Ch. ILHR 56 Places of Instruction	A	I	A or B	II	A, B or C	DOC FF-1 ⁶
Ch. ILHR 57 Residential Occupancies	A	II	A or B	II	A, B or C	DOC FF-1 ⁶
Ch. ILHR 58 Health Care and Places of Detention	SEE CHAPTER ILHR 58 FOR SPECIFIC REQUIREMENTS					
Ch. ILHR 59 Hazardous Occupancies	A	DOC FF-1 ⁶	A or B	DOC FF-1 ⁶	A, B or C	DOC FF-1 ⁶
Ch. ILHR 60 Day Care Centers (20 Children or Less)	A or B	DOC FF-1 ⁶	A or B	DOC FF-1 ⁶	A, B or C	DOC FF-1 ⁶
Ch. ILHR 60 Day Care Centers (More than 20 Children)	A	II	A or B	II	A, B or C	DOC FF-1 ⁶
Ch. ILHR 62 Specialty Occupancies	A, B or C	DOC FF-1 ⁶	A, B or C	DOC FF-1 ⁶	A, B or C	DOC FF-1 ⁶

Notes to Table 51.07

¹ Exposed portions of structural members of Type No. 4-Heavy Timber Construction are not subject to the requirements of this table.

² Where a complete automatic sprinkler system is installed, materials with an interior finish of Class B or C may be used in places where Class A or B materials, respectively, are required and floor finish materials with an interior finish of Class II or materials complying with the DOC FF-1-70 "pill test" may be used in places where Class I or II materials, respectively, are required.

³ Requirements for rooms or enclosed spaces are based upon the spaces being separated from exit access corridors and exits by partitions extending from the floor to the ceiling. Where the room or enclosed space is not separated from the exit access corridor, the room or space is considered part of the exit access or the exit.

⁴ Materials having napped, tufted, looped or similar surfaces, such as carpet, when applied on walls or ceilings shall meet the requirements for Class A interior finish.

⁵ Wood, vinyl, linoleum, terrazzo, resilient and other approved finished floors or floor covering materials are exempt from the provisions of this table.

⁶ All carpet manufactured for sale in the U.S. is required by federal regulations to comply with the DOC FF-1-70 "pill test" (16 CFR Para 1630). If a material other than carpet is used, the material should be shown to be resistant to flame propagation as a material which passes the DOC FF-1-70 test (minimum critical radiant flux of 0.04 watts/cm²).

⁷ Class C interior finish materials may be used in places of assembly with a capacity of 400 persons or less.

(6) APPLICATION OF INTERIOR FINISH. (a) *Attachment*. Interior finish materials shall be applied or otherwise fastened in such a manner that they will not readily become detached when subjected to room temperature of 200° F. or less for 30 minutes, or otherwise become loose through changes in the setting medium from the effects of time or conditions or occupancy.

(b) *Application to structural elements*. 1. Interior finish materials applied to walls, ceilings or structural elements of a building or structure which are required to be of fire-resistive rated or noncombustible construction shall be applied directly against the exposed surface of such structural elements or to furring strips attached to such surfaces.

2. Where furring strips are used, all concealed spaces shall be firestopped into areas not greater than 10 square feet in area or 8 feet in any dimension.

(c) *Furred construction*. Where walls, ceilings or other structural elements are required to be of fire-resistive rated or noncombustible construction, and the interior finish is set out or dropped distances greater than 1½ inches from the surface of the elements, only material of which both faces qualify as Class A shall be used, unless the finish material is protected on both sides by an approved automatic fire suppression system or is attached to a noncombustible backing as specified in par. (e) or to furring strips applied directly to such backing as specified in par. (b).

(d) *Class B and C finish materials*. Interior finish materials, other than Class A materials, which are less than ¼ inch in thickness shall be applied directly against a noncombustible backing or a backing of fire-retardant treated wood unless the tests under which the material has been classified were made with the materials suspended from the noncombustible backing.

(e) *Backing material*. 1. Backing for interior finish materials shall be a continuous surface with permanently tight joints, equal in area to the

area of the finish, and extending completely behind such finish in all directions.

2. Backing shall be of noncombustible or fire retardant treated wood materials.

3. When the backing does not constitute an integral part of the structural elements or system, it shall be attached directly to the structural elements or to furring strips as specified in par. (b) or may be suspended from the structural members at any distance provided concealed spaces are firestopped as specified in s. ILHR 53.63 (1).

Note: See s. ILHR 51.01 (75a) for further explanatory information.
 Class A Interior Finish — flame spread 0-25, smoke developed 0-450.
 Class B Interior Finish — flame spread 26-75, smoke developed 0-450.
 Class C Interior Finish — flame spread 76-200, smoke developed 0-450.
 Class I Interior Floor Finish — critical radiant flux — .45 watts/cm².
 Class II Interior Floor Finish — critical radiant flux — .22 watts/cm².

History: Cr. Register, December, 1981, No. 312, eff. 1-1-82; am. table, Register, October, 1982, No. 322, eff. 11-1-82; renum. (3) to be (3) (a), cr. (3) (b) and (6), Register, December, 1983, No. 336, eff. 1-1-84; am. (6) (d) (intro.), Register, August, 1985, No. 356, eff. 1-1-86.

ILHR 51.08 Occupancy separations. (1) When a building is used for more than one occupancy purpose, each part of the building comprising a distinct occupancy division shall be separated from any other occupancy division as provided for under the occupancy requirements of this code.

(2) Occupancy separations shall be classified as absolute, special and ordinary and shall apply to both horizontal and vertical separations.

(a) An absolute occupancy separation shall consist of walls or floors or both of not less than 4-hour fire-resistive construction as specified in ss. ILHR 51.04 to 51.049. All openings in walls forming such a separation shall be protected by self-closing fire-resistive door assemblies as specified in s. ILHR 51.047. The total width of all openings in any such separating wall in any one story shall not exceed 25% of the length of the wall in that story. Floor openings shall be protected by 4-hour rated shaft enclosures or fire curtain doors as specified in s. ILHR 64.42.

1. All openings in floors forming an absolute occupancy separation shall be protected by vertical enclosures extending above and below such openings.

2. The walls of such vertical enclosures shall be of not less than 3-hour fire-resistive construction as specified in ss. ILHR 51.04 to 51.049, and all openings shall be protected by self-closing fire-resistive door assemblies as specified in s. ILHR 51.047.

(b) A special occupancy separation shall consist of walls or floors, or both, of not less than 3-hour fire-resistive construction as specified in ss. ILHR 51.04 to 51.049. All openings in walls forming the separation shall be protected by automatic closing or self-closing fire-resistive door assemblies as specified in s. ILHR 51.047. The total width of all openings in any such separating wall in any one story shall not exceed 25% of the length of the wall in that story. Floor openings shall be protected by 3-hour rated shaft enclosures or fire curtain doors as specified in s. ILHR 64.42.

1. All openings in floors forming a special occupancy separation shall be protected by vertical enclosures extending above and below such openings.

2. The walls of such vertical enclosures shall be of not less than 2-hour fire-resistive construction as specified in ss. ILHR 51.04 to 51.049, and all openings shall be protected by self-closing fire-resistive door assemblies as specified in s. ILHR 51.047.

(c) An ordinary occupancy shall have walls or floors, or both, of not less than 1-hour fire-resistive construction as specified in ss. ILHR 51.04 to 51.049. All openings in such separations shall be protected by self-closing fire-resistive door assemblies as specified in s. ILHR 51.047.

History: 1-2-56; r. and recr. (2) (c), Register, October, 1967, No. 142, eff. 11-1-67; am. (2) (a), (b) and (c), Register, February, 1971, No. 182, eff. 7-1-71; r. and recr. (2) (a), (b) and (c) eff. 8-1-71 and expiring 1-1-72 and cr. (2) (a), (b) and (c) eff. 1-1-72, Register, July, 1971, No. 187; am. (2) (b) 1., Register, December, 1978, No. 276, eff. 1-1-79; r. and recr. (2), Register, December, 1981, No. 312, eff. 1-1-82; am. (2) (a) and (b) (intro.), Register, October, 1982, No. 322, eff. 11-1-82; am. (2) (a) (intro.) and (b) (intro.), Register, August, 1985, No. 356 eff. 1-1-86.

ILHR 51.14 Safety glazing. (1) **SCOPE.** This section applies to fixed or **FP** operating glazed flat panels adjacent to doors; fire window assemblies; display cases within 7 feet of the floor in schools; mirrors; framed, glazed pictures or similar decorative objects; skylights; sloped glazing and any other glazing materials used in hazardous impact areas which are not included within the scope of the federal consumer product safety commission (CPSC) standard for architectural glazing materials, 16 CFR, para. 1201.

Note: The CPSC standard for architectural glazing materials pre-empts state and local regulations for framed or unframed interior or exterior glazed doors, exterior doors with glazed lights, sliding doors and the adjacent glazed fixed or operating panel, storm doors, shower doors, walk-in mirror closet doors and tub enclosures.

(2) **APPLICATION.** All glazing material used in hazardous impact locations shall be safety glazing material. All replacements of glazing material in hazardous impact locations made after November 30, 1976, shall be safety glazing, except that the replacement of glazing shall be as specified in sub. (3).

(a) **Location.** Hazardous impact locations shall include all glazed elements such as framed or unframed interior or exterior glass doors, the first fixed or operating flat panel within 2 feet of nearest vertical edge of an entrance or exit door, exterior doors with glass lights, or any other glazed elements which may be mistaken for a means of egress or ingress to a room or building. Other hazardous impact locations shall include sliding doors and the adjacent glazed fixed or operating panel, storm doors, shower doors, tub enclosures and display cases within 7 feet of the floor in schools except as follows:

1. A fixed or operating flat panel immediately adjacent to an entrance or exit door is exempt from the requirements of this paragraph if the lower horizontal edge of the panel is 2 feet or more above the floor; or

2. Any mirror, framed glazed picture or similar decorative object which is attached to a door or wall in a hazardous impact location and which does not in whole or in part conceal any opening in such door or wall is exempt from the requirements of this paragraph.

(b) *Material.* Safety glazing shall include any glazing material including but not limited to tempered glass, laminated glass, wired glass, safety plastic, or safety insulating units which meet the test requirements of the American National Standards Institute (ANSI) standard Z97.1-1975, and which are constructed, treated or combined with other materials so as to minimize the likelihood of cutting and piercing injuries resulting from human impact with the glazing material.

(c) *Labeling.* Safety glazing material shall be labeled with a permanent label by such means as etching, sand blasting, firing of ceramic material, or hot die stamping. The label shall be legible and visible after installation. Labels identifying safety glazing materials may be omitted provided that a notarized affidavit or invoice is submitted to the department or owner upon request certifying the installation of safety glazing material. The label or affidavit shall identify the seller, manufacturer, fabricator, or installer, the nominal thickness and type of safety glazing material, and the fact that the material meets the test requirements of the American National Standards Institute (ANSI) standards Z97.1-1975.

(3) **GUARDING OF GLAZING.** All interior and exterior glazed panels, subject to human impact not in a hazardous impact location, shall be guarded or provided with safety glazing, except that glazed panels with a sill height of 2 feet or more, or glazed panels less than 12 inches in width, are not required to be safety glazed or guarded.

(a) Guarding shall consist of a horizontal bar, rail, mullion, grille or screen at least 1-½ inches wide and located within 3 feet 6 inches to 4 feet 6 inches above the floor. The guard assembly shall be capable of withstanding a lateral force of 100 pounds applied at any point and installed to avoid contact with the glazing when the force is applied.

(b) Safety glazing materials shall be as specified in sub. (2) (b).

(c) For replacement of glazing in buildings contracted for or existing prior to November 30, 1976, the installation of a horizontal bar, rail, mullion, grille or screen as a protective device may be provided in lieu of safety glazing material in hazardous impact locations where safety glazing would be impractical because of the size of the light required.

(4) **INTERIOR DOORS WITH GLASS LIGHTS.** (a) All interior doors with glass lights greater than 8 inches in the least dimension shall be provided with safety glazing material.

(b) All interior doors with glass lights less than 8 inches in the least dimension shall be provided with ¼-inch glazing material.

(c) Safety glazing materials shall be as specified in sub. (2) (b).

(5) **SKYLIGHTS AND SLOPED GLAZING.** (a) *Skylights.* All glazing in skylights shall be safety glazing material and shall comply with the requirements specified in s. ILHR 51.065 (5) or (6).

(b) *Sloped glazing.* All glazing installed more than 15° with the vertical shall be safety glazing material. This paragraph does not apply to greenhouses.

(6) **FIRE WINDOW ASSEMBLIES.** All glazing in fire window assemblies shall be designed and installed as specified in s. ILHR 51.048.

(7) **STRUCTURAL REQUIREMENT.** Glazing material shall be designed and installed to safely withstand the loads specified in ch. ILHR 53.

Note: Section 101.125, Stats., requires safety glazing in all hazardous locations.

History: Cr. Register, December, 1981, No. 312, eff. 1-1-82; am. (5) (a), Register, August, 1985, No. 356, eff. 1-1-86.

ILHR 51.15 Standard exit. (1) Every door which serves as a required exit from a public passageway, stairway or building shall be a standard exit door unless exempted by the occupancy requirements of this code.

Note: See ss. ILHR 54.06, 55.10, 56.08, 57.06, 58.04, 58.49, 59.14, 60.12, 61.12, 62.26, 62.47 and 62.75 for requirements regarding required exits.

(2) Every standard exit door shall swing outward or toward the natural means of egress. It shall be level with the floor, and shall be so hung that, when open, it will not block any part of the required width of any other doorway, passageway, stairway or fire escape. No revolving door, overhead door or sliding door shall be considered as a standard exit. **FP**

(3) (a) A standard exit door shall have such fastenings or hardware that it can be opened from the inside by pushing against a single bar or plate or turning a single knob or handle. The latch or other approved fastening device on the door shall be of an obvious method in its release. Except as provided in pars. (b) to (d), the installation of hardware requiring use of a key for opening an exit door from the inside is prohibited. The requirements of this subsection, except par. (f) shall apply to all buildings in existence and to any building built after the effective date of this subsection.

(b) Exit and exit access doors serving individual living units may be provided with hardware requiring the use of a key for opening from the inside.

(c) Upon written request to the department by the owner, key-locking, or securing, of exits may be approved in fire-resistive buildings, or parts of fire-resistive buildings, which are used as jails, prisons, mental institutions, asylums, nursing homes with senile patients, and similar type occupancies.

Note #1: The owners request should include the following considerations: accessibility of keys to the fire department and staff personnel for the locked areas; electrical devices which release the locks; and 24-hour supervision of the locked areas by personnel who carry keys for the locked areas while on duty. Electrical devices which release the locks upon power failure or upon activation of the fire alarm or sprinkler system or the product of combustion detectors should be considered for securing of exits in nursing homes.

Note #2: Written approval to lock exits must also be obtained from the department of health and social services in accordance with the rules of that department.

(d) 1. One door serving as an exit from any building housing any office or wholesale or retail store may be equipped with hardware which requires use of a key to open it from the inside provided one of the following conditions is satisfied: **FP**

a. The door has a window which has a minimum clear opening of not less than 24 inches, and 6 square feet in area with the bottom of the window opening not more than 4 feet above the inside floor level;

b. A glazed sidelight satisfying the dimensional and location requirements for the windows specified in par. (a) is located adjacent to the door; or

c. A window satisfying the dimensional and location requirements for the window specified in par. (a) is located within five feet of the door.

2. Approved safety glazing shall be used in all installations but the glazing may not be bullet-resistant or break-resistant.

3. The door may not be used as an exit serving any required exit stairway enclosure.

4. The door shall not be key-locked during periods of occupancy by the public or employees. A readily visible, permanent sign shall be placed on or adjacent to the door on the egress side stating, "THIS DOOR SHALL NOT BE KEY-LOCKED WHEN THE BUILDING IS OCCUPIED". The sign shall be in letters at least one inch in height on a contrasting background.

5. The use of keyed hardware as specified in this section may be revoked by the department or its authorized deputy upon one violation of any of the conditions specified in subs. 1. to 4.

(e) 1. Except as provided in subd 2., the door shall not be barred, bolted or chained at any time.

2. When authorized persons, such as employees, frequenters, patrons and other such occupants are not present, the exit door may be secured by the use of a single bar or bolt. A sign or label shall be posted on the door near the single bar or bolt. The sign or label shall bear the following: "This bolt or bar shall be kept open during periods of occupancy."

Note: The intent of subd. 2. is to prohibit padlocks or use of a key to open a door or lock at any time. The bar and bolt exception is to give security against intruders from the outside while protecting persons in the building from being trapped.

(f) 1. Except as provided in subd. 2., the latch or other approved fastening device shall be located on the exit door so that the device is not less than 32 inches or more than 54 inches above the floor level.

2. The latch or approved fastening device on solid tempered glass doors may be located on the door at the floor line.

FP (4) A standard exit door shall not be less than 6 feet 4 inches high by 3 feet 0 inches wide, except where especially provided under occupancy classifications and in s. ILHR 51.20. Where double doors are provided with or without mullions, the width of each single door may be reduced to 2 feet 6 inches, except double doors utilized to provide accessibility in accordance with s. ILHR 52.04 shall have the width of at least one single door increased to 2 feet 8 inches.

(5) All exit doors, unless otherwise exempted by the occupancy requirements of this code, shall be plainly marked by a red illuminated translucent exit sign bearing the word EXIT or OUT in plain letters not less than 5 inches in height and in such other places as may be necessary to direct the occupants to exit doorways.

(6)* **REQUIRED AGGREGATE WIDTH.** (a) The required aggregate width of exits from a level shall be determined by using the full occupant load of that level, plus the percentage effects of the occupant loads of adjacent levels (above and below) which exit through it as follows:

*See Appendix A for further explanatory material.

1. 50% of the occupant load of each first-adjacent level; and
2. 25% of the occupant load of each second-adjacent level.

(b) The width shall be based upon the following ratios:

1. Types No. 1 through No. 4 construction unsprinklered, 40 inches per 100 persons;
2. Types No. 5 through No. 8 construction unsprinklered, 50 inches per 100 persons;
3. Types No. 1 through No. 4 construction sprinklered, 30 inches per 100 persons; or
4. Types No. 5 through No. 8 construction sprinklered, 40 inches per 100 persons.

Note: The determination of exit width for health care facilities is specified in s. ILHR 58.12 (2) and (3) and takes precedence over this section.

(c) The required aggregate width of exits from assembly seating facilities shall comply with the requirements of s. ILHR 62.75 (4).

History: 1-2-56; am. Register, December, 1962, No. 84, eff. 1-1-63; am. (5) and cr. (7), Register, November, 1963, No. 95, eff. 12-1-63; r. and recr., Register, October, 1967, No. 142, eff. 11-1-67; am. (7) (j), Register, May, 1968, No. 149, eff. 6-1-68; r. and recr. (7), Register, December, 1970, No. 180, eff. 1-1-71; r. and recr. (3), Register, February, 1971, No. 182, eff. 3-1-71; am. (7) (a) 1., Register, September, 1973, No. 213, eff. 10-1-73; r. (7), r. and recr. (6), Register, December, 1974, No. 228, eff. 1-1-75; emerg. cr. (3) (b) 1., eff. 6-20-75; cr. (3) (a) 1. and (3) (b) 1., Register, November, 1975, No. 239, eff. 12-1-75; am. (4), Register, December, 1977, No. 264, eff. 1-1-78; am. (2) and (3) (b) 1., Register, December, 1978, No. 276, eff. 1-1-79; am. (4), Register, January, 1980, No. 289, eff. 2-1-80; am. (2), r. and recr. (3) (a), (intro.), cr. (6) (c), Register, December, 1981, No. 312, eff. 1-1-82; cr. (3) (c), Register, December, 1983, No. 336, eff. 1-1-84; r. and recr. (3), Register, January, 1985, No. 349, eff. 2-1-85; am. (3) (a) and (4), cr. (3) (e) and (f), Register, August, 1985, No. 356, eff. 1-1-86.

ILHR 51.151 Exit distribution. All spaces which can accommodate more than 25 persons shall be provided with a minimum of 2 exits, 2 exit access doors or a combination of both which are located to provide the best possible egress from the room or suite. If exit access doors are used, the exit access corridors shall lead to 2 or more separate exits.

Note 1: See Appendix A for further explanatory material.

Note 2: See occupancy chs. ILHR 54 to 62 for acceptable types of exits and exit accesses and exceptions.

History: Cr. Register, August, 1985, No. 356, eff. 1-1-86.

ILHR 51.16 Stairways and ramps (1) DEFINITIONS. (a) "Stairway" means one or more flights of steps, and the necessary platforms or landings connecting them, to form a continuous passage from one elevation to another, including exterior porches, platforms and steps.

(b) "Ramp" means a sloping floor or walk and necessary platforms or landings connecting them to form a continuous passage from one elevation to another.

(2) **REQUIRED AGGREGATE WIDTH.** (a) The required aggregate width of stairway or ramp exits from any level shall be as specified in s. ILHR 51.15 (6).

(b) In no case shall the minimum width of an exit stair or ramp be less than that specified in sub. (3).

(c) Under no circumstances shall stairways or ramps decrease in width in the line of travel toward the exit.

(3) **MINIMUM WIDTH.** (a) Except as provided in par. (b), every required exit stairway or ramp under chs. ILHR 54 to 62 shall be not less than 3 feet 8 inches wide, except as provided in the occupancy chapters, of which not more than 4 inches on each side may be occupied by a handrail. The clear dimension between handrails, or stringers, shall not be less than 3 feet 0 inches.

(b) 1. Nonrequired stairways or ramps need not conform to the width requirements specified in chs. ILHR 50 to 64.

2. Stairway chair lifts, but not platform lifts, for the physically disabled may be installed on the right side as one mounts the stairs on required exit stairways of buildings constructed prior to May 14, 1974.

a. A clear stair width of 24 inches measured from the lift, in its open position, to the nearer edge of the opposite handrail and a clear dimension of 3 feet between the lift mounting track or traveling means and the handrail shall be provided.

b. The lift shall be designed and installed to maintain the code required exit passageway or stair width when the lift is in the parked or stored position.

c. Lifts may not encroach more than 24 inches into the net width determined by s. ILHR 51.15 (6), when in the operating configuration.

(4) **RISERS, TREADS AND RAMP SLOPES.** Risers and treads shall be designed and provided in accordance with the following:

(a) All stairways and steps shall have a rise of not more than 7¼ inches and a tread not less than 9½ inches, measured from tread to tread and from riser to riser. Treads and risers shall be uniform in any one flight. Winders shall not be used;

Note #1: The department recommends that steps be proportioned so the sum of 2 risers and a tread, exclusive of its nosing or projection, should be not less than 24 inches or more than 25 inches.

Note #2: The department may accept nonstandard exit stairways serving unoccupied areas, such as equipment mezzanines or platforms, and similar areas, if approved in writing.

Note #3: Round or smooth nosings are recommended as they are not difficult to negotiate for individuals with restrictions in the knee, ankle or hip, or with artificial legs or long leg braces.

(b) The edges of all treads and the edges of all stairway landings shall be finished with a nonslippery surface not less than 3 inches in width;

(c) Where an exit door leads to an outside platform or sidewalk, the level of the platform or sidewalk shall not be more than 7¼ inches below the doorsill;

(d) Every stairway flight shall have at least 3 risers (unless additional safety is provided which meets the approval of the department); and

(e) There shall be no more than 22 risers in any one flight.

(f) 1. Ramp slopes of required exit ramps may not exceed 1:8.

2. Ramp slopes of all ramps not included under subd. 1. may not exceed 1:6.

Note: See s. ILHR 52.04 (7) for ramp requirements for barrier free design.

(g) Ramps and landings shall be finished with a slip-resistant surface.

(5) STAIRWAY AND RAMP LANDINGS AND PLATFORMS. (a) 1. Except as provided in subd. 2., if a door is provided at the head or foot or both of a stairway or ramp, a landing or platform shall be placed between the door and the stairway or ramp regardless of the direction of swing of the door.

2. Platforms may be omitted for ramps 6 foot or less in length.

(b) Every landing or platform shall be at least as wide as the stairway or ramp, measured at right angles to the direction of travel. Every landing or platform must have a length of at least 3 feet, measured in the direction of travel.

(c) Spaces beneath stairs and ramps may not be enclosed for any use. FP

(6) CURVED STAIRS. Interior or exterior curved stairs used as required exits shall meet all the requirements for stairways. Curved stairs shall have a radius of at least 25 feet at the interior edge of the tread.

(7) SPIRAL STAIRS. Spiral stairways may be permitted as specifically allowed by the occupancy chapters of this code. Such spiral stairs shall provide a clear walking area measuring at least 22 inches from the outer edge of the supporting column to the inner edge of the handrail and shall have treads at least 7 inches in width at a point one foot from the narrow end of the tread, and a uniform riser height of not more than 8 inches.

History: 1-2-56; am. (2); (2) (a); (2) (b); Register, June, 1956, No. 6, eff. 7-1-56; r. and recr. Register, September, 1959, No. 45, eff. 10-1-59; r. (4) (b), renum. (c) to be (b), and cr. (5), Register, February, 1971, No. 182, eff. 3-1-71; am. (2) (a), Register, September, 1973, No. 213, eff. 10-1-73; r. and recr. Register, December, 1974, No. 228, eff. 1-1-75; am. (4) (a) and cr. (10), Register, December, 1977, No. 264, eff. 1-1-78; cr. (7) (a), Register, December, 1978, No. 276, eff. 1-1-79; r. (5) to (7), renum. (8) to (10) to be (5) to (7) and am. (7), Register, January, 1980, No. 289, eff. 2-1-80; r. and recr. (1), am. (2), (3) (a) and (5), renum. (3) (b) to be (3) (b) 1. and am., cr. (3) (b) 2., (4) (f) and (g), Register, August, 1985, No. 356, eff. 1-1-86.

ILHR 51.161 Handrails. (1) WHERE REQUIRED. Handrails shall be provided in all of the following conditions unless otherwise specified in the occupancy chapters of this code. FP

(a) On the left side, as one mounts the stairs or ramp, on all interior stairways of more than 3 risers and on all ramps overcoming a change in elevation of more than 24 inches.

(b) On the open side of any stairway with more than 3 risers and on the open side of any ramp overcoming a change in elevation of more than 24 inches.

(c) On both sides of interior stairways or ramps 5 feet or more in width.

(d) To divide interior stairways or ramps more than 8 feet wide into widths at least 3 feet 8 inches but less than 8 feet.

(e) On both sides of exterior stairways with more than 3 risers and on both sides of exterior ramps overcoming a change of elevation of more than 24 inches, either of which are an integral part of the building.

(f) To divide exterior stairways or ramps, either of which are an integral part of the building and more than 25 feet wide into approximately equal widths not less than 3 feet 8 inches but not greater than 25 feet.

(g) The requirements specified in pars. (a) to (f) do not apply to ramps having a slope less than 1:20.

Note: See s. ILHR 52.04 (7) (c) for handrail requirements for ramps used to provide barrier free access.

(h) On fire escapes as specified in s. ILHR 51.20 (8).

(2) **LOADING.** All handrails shall be designed and constructed to withstand a load of 200 pounds applied in any direction at any point.

(3) **HEIGHT.** Handrails, except those serving fire escapes, shall be not less than 30 inches nor more than 34 inches above the nosing of the treads on stairways or above the surface of ramps.

Note: See s. ILHR 51.20 (8) for handrail requirements for fire escapes.

(4) **CONTINUITY AND EXTENSIONS.** (a) Except as provided in par. (b), handrails shall be continuous for the full length of the stairway or ramp and one handrail shall extend at least 12 inches beyond the top and bottom riser or ramp end and shall not constitute a projecting hazard.

(b) 1. Handrails not required for barrier-free design construction on assembly seating facilities need not comply with the 12 inch extension requirement.

2. Handrails on stairs located within individual living units need not comply with the requirements of par. (a).

(5) **CLEARANCE.** Handrails shall provide a clearance of at least 1½ inches between the handrail and the wall to which it is fastened.

(6) **OPENINGS BELOW TOP RAIL.** (a) Handrails protecting the open sides of stairways and ramps subject to use by children shall have intermediate rails or an ornamental pattern designed to prevent the passage of an object with a diameter larger than 9 inches.

(b) Handrails protecting the open sides of stairways and ramps not subject to use by children (i.e., waste water treatment plants, foundries, tanneries and other industrial occupancies) shall be provided with an intermediate rail at mid height or equivalent.

History: Cr. Register, January, 1980, No. 289, eff. 2-1-80; am. (4), Register, December, 1981, No. 312, eff. 1-1-82; am. (1) (a) to (g), renum. (4) (b) to be (4) (b) 1., cr. (4) (b) 2., Register, August, 1985, No. 356, eff. 1-1-86.

FP ILHR 51.162 Guardrails. (1) **WHERE REQUIRED.** Guardrails shall be provided in all of the following conditions unless otherwise specified in the occupancy chapters of this code:

(a) On the open side of elevated platforms, landings, walks, balconies and mezzanines which are more than 24 inches in height;

(b) On assembly seating facilities as specified in s. ILHR 62.77;

(c) On open parking structures as specified in s. ILHR 62.28 and as indicated in sub. (5); and

(d) On openings through floors and roofs.

Register, August, 1985, No. 356

(2) **EXEMPT LOCATIONS.** Guardrails need not be provided on the loading side of loading docks.

(3) **LOADING.** (a) Except as provided in par. (b), all guardrails shall be designed and constructed to withstand a load of at least 200 pounds applied in any direction at any point.

(b) All guardrails on assembly seating facilities shall be designed and constructed to withstand a vertical and horizontal load of 50 pounds per linear foot. Loads need not be applied simultaneously.

(4) **HEIGHT.** Guardrails shall not be less than 3 feet 6 inches in height.

(a) *Exception.* Guardrails within individual living units may be 36 inches in height.

(b) *Exception.* Guardrails on a balcony immediately in front of the first row of fixed seating and which are not at the end of an aisle may be 30 inches in height.

(5) **OPENINGS BELOW TOP RAIL.** (a) Guardrails in areas subject to use by children shall have intermediate rails or an ornamental pattern designed to prevent the passage of an object with a diameter larger than 9 inches.

(b) Guardrails in areas not subject to use by children shall be provided with an intermediate rail at mid height or equivalent.

History: Cr. Register, January, 1980, No. 289, eff. 2-1-80; am. (1) (b), (3) and (4) (b), Register, December, 1981, No. 312, eff. 1-1-82.

ILHR 51.164 Headroom. (1) **GENERAL.** Except as provided in sub. (2), every means of egress shall be provided with a headroom clearance of not less than 6 feet 8 inches. In stairways, the clearance shall be 7 feet 0 inches established by measuring vertically from the edge of the tread nosing to the ceiling or soffit above the tread nosing.

(2) **EXCEPTION.** The headroom clearance for public stairways in apartments and townhouses may be reduced to not less than 6 feet 8 inches.

Note: See s. ILHR 57.07 (3) for requirements pertaining to stairways within individual living units.

History: Cr. Register, January, 1980, No. 289, eff. 2-1-80; am. Register, December, 1983, No. 336, eff. 1-1-84.

ILHR 51.165 Stairway identification. All stairways serving 4 or more stories shall have each floor level or story identified on the stair side as to its name or number with a permanent sign having letters or characters at least 2 inches in height. **FP**

History: Cr. Register, December, 1981, No. 312, eff. 1-1-82.

ILHR 51.166 Stairway discharge. Where a stairway from the level below the exit discharge and a stairway from an upper floor terminate at the same exit discharge level, an approved barrier shall be provided to prevent persons from continuing down one or more full floor levels below the exit discharge level unless the exit discharge level has a vision panel to the outside or is otherwise made readily apparent. **FP**

History: Cr. Register, December, 1981, No. 312, eff. 1-1-82; am. Register, October, 1982, No. 322, eff. 11-1-82.

FP ILHR 51.167 Exiting through areas of hazard. (1) **GENERAL.** Except as provided in subs. (2) and (3), exit access shall be so arranged that it will not be necessary to travel through any area of hazard in order to reach the exit.

Note: See ss. ILHR 54.14, 55.29, 56.15, 57.14, 58.24, 58.62, 59.21, 60.25, 60.37, 62.32 for additional requirements.

(2) **GARAGES.** (a) Occupancies within the scope of ch. ILHR 54 may exit through storage garages.

(b) Occupancies within the scope of ch. ILHR 54 may not exit through repair garages.

(c) Occupancies within the scope of chs. ILHR 55-62 may not exit through a storage or repair garage.

(3) **KITCHENS.** (a) Exiting through a kitchen within an individual living unit is permitted.

(b) Exiting through kitchens equipped with residential-type appliances in areas such as but not limited to employe lounges, activity rooms and similar areas is permitted provided the kitchen is not used for commercial purposes.

(c) Exiting through kitchens of restaurants and similar commercial operations or kitchens equipped with commercial-type appliances is prohibited.

History: Cr. Register, December, 1981, No. 312, eff. 1-1-82; am. Register, October, 1982, No. 322, eff. 11-1-82.

ILHR 51.17 Smokeproof stair tower. (1) A smokeproof stair tower shall be an enclosed stairway which is entirely cut off from the building and which is reached by means of open balconies or platforms. The stairways, landings, platforms and balconies shall be of noncombustible material throughout. The enclosing walls shall be of not less than 4-hour fire-resistive construction, and the floors and ceilings of not less than 2-hour fire-resistive construction as specified in s. ILHR 51.04.

(2) The doors leading from the buildings to the balconies and from the balconies to the stairways shall be fire-resistive doors, and all openings within 10 feet of any building shall be protected with fire-resistive windows for moderate fire exposure, or fire-resistive doors as specified in s. ILHR 51.047.

(3) Each balcony shall be open on at least one side, with a railing not less than 3'6" high on all open sides.

History: 1-2-56; am. Register, December, 1962, No. 84, eff. 1-1-63; am. (1) and (2), Register, February, 1971, No. 182, eff. 7-1-71; r. and recr. (1) and (2) eff. 8-1-71 and exp. 1-1-72, and cr. (1) and (2) eff. 1-1-72, Register, July, 1971, No. 187; am. (2), Register, June, 1972, No. 198, eff. 7-1-72.

ILHR 51.18 Interior enclosed stairway. (1) **GENERAL.** An interior enclosed stairway shall be separated from other areas of the building by fire-resistive rated construction as specified in ss. ILHR 51.04 to 51.049 with the hourly ratings as specified in Table 51.03-A.

(2) **EXTENT OF ENCLOSURE.** (a) The enclosure shall include at each floor level a portion of the floor which will be at least as wide as the stairway.

Register, August, 1985, No. 356

(b) The enclosure shall provide uninterrupted passage from the uppermost floor to an outside door without leaving the enclosure.

(c) The enclosure shall also include any passageway, if provided, on the floor of exit discharge leading from the stairway to the exit discharge, so as to afford uninterrupted passage from the uppermost floor to the exit discharge, without leaving the enclosure.

(3) **OPENINGS IN THE ENCLOSURE.** Openings in the stairway enclosure shall be limited to exit doors serving public passageways or corridors or serving floors occupied by a single tenant.

Note: See ch. Ind 4 for additional requirements pertaining to the location of elevator equipment room access doors.

(4) **PROTECTION OF OPENINGS.** (a) All openings for doors shall be protected by fire-rated door assemblies as specified in s. ILHR 51.047.

(b) If windows are provided in the enclosure, the window openings shall be protected by fixed fire-rated window assemblies as specified in s. ILHR 51.048, except in outside walls.

History: 1-2-56; am. (1) and (3), Register, February, 1971, No. 182, eff. 7-1-71; r. and recr. (1) and (3), eff. 8-1-71 and exp. 1-1-72, and cr. (1) and (3), eff. 1-1-72, Register, July, 1971, No. 187; r. and recr. (1), Register, June, 1972, No. 198, eff. 1-1-73; am. (3), Register, December, 1975, No. 240, eff. 1-1-76; am. (2), Register, January, 1980, No. 289, eff. 2-1-80; r. and recr., Register, December, 1981, No. 312, eff. 1-1-82.

ILHR 51.19 Horizontal exit. (1) **GENERAL.** A horizontal exit shall consist of one or more openings through an occupancy separation; a 2-hour fire-rated separation wall extending from the basement or lowest floor to the underside of the roof deck or of one or more bridges or balconies connecting 2 buildings or parts of buildings entirely separated by occupancy separations as described in s. ILHR 51.08.

(2) **PROTECTION OF OPENINGS.** Openings used in connection with horizontal exits shall be protected by fire-resistive doors as specified in s. ILHR 51.047.

(a) Doors serving as required exits shall be standard exit doors and shall swing in the direction of exit travel. Where a horizontal exit serves spaces on both sides of the wall, there shall be adjacent doorways equipped with doors which swing in opposite directions.

1. *Exceptions.* a. The swing of the exit door may comply with the exceptions permitted in the occupancy chapters of this code.

(b) Approved illuminated exit signs shall be provided to indicate the horizontal exit.

(c) Such doors shall be kept unlocked, unobstructed, provided with a self-closing device and normally be kept closed.

1. *Exception.* Doors protecting openings used in connection with horizontal exits may be left opened if equipped with an automatic closing device actuated by smoke density or products of combustion other than heat.

Note: The department will accept detectors installed in accordance with the Standard on Automatic Fire Detectors, NFPA No. 72-E [ILHR 51.27 (7a)].

(3) **RAMP SLOPE.** Where there is a difference of elevation between connected areas, the difference shall be overcome by a ramp with a slope of not more than one foot in 8.

(4) **PROJECTION OF ADJACENT OPENINGS.** All doors and windows within 10 feet of any balcony or bridge shall be fire-resistive doors or fire-resistive windows as specified in ss. ILHR 51.047 and 51.048.

History: 1-2-56; am. (2) and (4), Register, February, 1971, No. 182, eff. 7-1-71; r. and recr. (2) and (4) eff. 8-1-71 and exp. 1-1-72, and cr. (2) and (4) eff. 1-1-72, Register, July, 1971, No. 187; am. (4) Register, June, 1972, No. 198, eff. 7-1-72; am. (4), Register, December, 1975, No. 240, eff. 1-1-76; r. and recr. Register, December, 1978, No. 276, eff. 1-1-79; am. (1) and (3), r. (2) (a) 1. a., renum. (2) (a) 1. b. to (2) (a) 1. a., Register, January, 1980, No. 289, eff. 2-1-80.

FP ILHR 51.20 Fire escapes. (1) **LOCATION.** Every fire escape shall be so located as to lead directly to a street, alley, or open court connected with a street.

(a) Every fire escape shall be placed against a blank wall if possible. If such a location is not possible then every wall opening which is less than 6 feet distant horizontally from any tread or platform of the fire escape shall be protected by a fire-resistive window for moderate fire exposure or by a fire-resistive door as specified in ss. ILHR 51.047 and 51.048.

(2) **EXITS TO FIRE ESCAPES.** Every fire escape shall be accessible from a public passageway or shall be directly accessible from each occupied room. Exits to fire escapes shall be standard exit doors as specified in s. ILHR 51.15, except that doors to "A" fire escapes may be not less than 2 feet 6 inches wide.

(3) **DESIGN AND FABRICATION.** Each part of every fire escape (except counterweights for balanced stairways) shall be designed and constructed to carry a live load of 100 pounds per square foot of horizontal area over the entire fire escape. Each part of every fire escape shall be designed and constructed in accordance with the requirements of s. ILHR 53.50, except that the unit stresses therein specified shall be reduced by one-fourth. The minimum sections and sizes specified below shall be increased whenever necessary so that under full load the allowable unit stresses will not be exceeded.

(a) No other material than wrought iron, soft steel or medium steel shall be used for any part of a fire escape, except for weights, separators and ornaments. No bar material less than ¼ inch thick shall be used in the construction of any fire escape, except for separators, ornaments, structural shapes over 3 inches and rigidly built up treads and platforms of approved design. In the fabrication of a fire escape, all connections or joints shall be made by riveting, bolting or welding in an approved manner. All bolts or rivets, except for ornamental work, shall be not less than ¾ inch in diameter.

(4) **PLATFORMS.** Each platform on an "A" fire escape shall be at least 28 inches wide; each platform on a "B" fire escape shall be at least 3 feet 4 inches wide. Such widths shall be the clear distance between stringers, measuring at the narrowest point. Each platform shall extend at least 4 inches beyond the jambs of exit opening. The above minimum widths and lengths shall be increased, wherever necessary, so that no exit door or window will, when open, block any part of the required width of the fire escape. Every platform shall consist of either,

(a) Flat bars on edge, not less than 1 x ¼ inch, but not less than 1¼ x ¼ inch where bolts and separators are used except that platforms and treads constructed of flat bars on edge may be made of material 3/16 inch in thickness provided the material is galvanized after fabrication. Bars shall not be spaced more than 1¼ inches, center to center.

(b) ½ inch or ¾ inch square bars with sharp edge up, not more than 1½ inches, center to center.

(c) ¾ inch round bars, not more than 1½ inches, center to center.

(d) Platform and treads may be solid if covered by a roof.

(e) The platform frame shall consist of not less than 2 x ¾ inch flat bars on edge or equivalent, provided the brackets are not more than 4 feet apart. If brackets are more than 4 feet apart, the frame shall be correspondingly stronger and stiffer. Every platform wider than 30 inches, if made of square or round bars, shall have a third frame bar through the center; if made of flat bars, the platform shall have separators and bolts through the center. Frame bars shall not project more than ¼ inch above platform bars, except around the outside of platform.

(f) There shall be a platform at each story above the first, and intermediate platforms if floors are more than 18 feet apart vertically.

(g) Platforms shall not be more than 8 inches below the door sill.

(5) BRACKETS. Brackets for a 28 inch or 30 inch platform, when spaced not more than 4 feet apart, shall be made of not less than ¾ inch square bars or 1½ x 1½ x ¼ inch angles; such bars or angles shall be larger if the platform is wider or if the brackets are farther apart. Each bracket shall be fastened at the top to the wall by a through bolt (at least ¾ inch diameter), nut, and washer (at least 4 inch diameter). The slope of the lower bracket bar shall be not less than 30° with the horizontal. The lower bar shall have a washer or shoulder to give sufficient bearing against the wall.

(a) The strength of the wall to which brackets are to be attached shall be carefully considered in determining the spacing, shape and inside connection of brackets, so that under full load the wall will not be unduly strained. Where it is necessary to install brackets adjacent to wall openings they shall be located at a suitable distance therefrom, or the wall shall be properly reinforced.

(6) STAIRWAYS. (a) Each stairway of an "A" fire escape shall be at least 24 inches wide between stringers; such stairway shall have a uniform rise of not more than 8 inches and a uniform run of not less than 8 inches.

(b) Each stairway of a "B" fire escape shall be at least 3 feet 4 inches wide between stringers; such stairway shall have a uniform rise of not more than 8 inches, and a uniform run of not less than 9 inches.

1. The rise is the vertical distance from the extreme edge of any step to the corresponding extreme edge of the next step. The run is the horizontal distance between the same points.

(c) Stairway stringers shall consist of either:

1. A 5 inch channel or larger.

2. Two angles 2 x 2 x ¼ inch or larger.

3. Two flat bars 2 x $\frac{3}{8}$ inch or larger.

4. One flat bar 6 x $\frac{3}{8}$ inch or larger.

5. If 2 angles or 2 flat bars are used, they shall be properly tied together by lattice bars, vertical as well as horizontal. If flat bars are used, every stairway of more than 10 risers shall have lateral bracing. The connection of stringers to platform, at top and bottom, shall be at least equal in strength to the stringers and shall safely carry the full live and dead loads. If stringers are carried by intermediate brackets, the stringers shall have a horizontal bearing on the brackets and shall be properly and securely connected thereto.

6. Treads shall consist of either flat or square bars, (not round), of the size and spacing specified for platforms. An "A" tread shall consist of at least 6 square bars, or 7 flat bars. A "B" tread shall consist of at least 7 square bars, or 8 flat bars. A "B" tread made of flat bars shall have separators and bolt through the center. A "B" tread made of square bars shall be trussed.

7. Treads and platforms may be solid if covered by a roof.

(7) **BALANCED STAIRWAY.** All "B" fire escapes, and all fire escapes on schools, theaters, assembly halls, hospitals, nursing homes, residential care institutions, group foster homes, and homes for the elderly either shall reach to the ground or shall have a balanced stairway reaching to the ground. "A" fire escapes which are not on schools, theaters, assembly halls, hospitals, nursing homes, residential care institutions, group foster homes and homes for the elderly may terminate in a platform at least 3 feet long, located not more than 10 feet above the ground and does not serve more than 8 persons.

(8) **RAILINGS.** A railing at least 42 inches in height measuring vertically from the floor of the platform, shall be provided on all open sides of platforms. Railings at least 36 inches in height, measuring vertically from the nose of the treads, shall be provided on the open sides of all stairways and on both sides of balanced stairways. Either a railing or a handrail fastened to the wall shall be provided on each side of all "B" fire escape stairways. Railings on fire escapes subject to use by children shall have intermediate rails or an ornamental pattern designed to prevent the passage of an object with a diameter larger than 9 inches. Railings on fire escapes not subject to use by children shall be provided with 2 uniformly spaced intermediate rails.

(a) Every railing shall have posts, not more than 5 feet apart made of not less than $1\frac{1}{2}$ x $1\frac{1}{2}$ x $\frac{1}{4}$ inch angles or tees, or $1\frac{1}{2}$ inch pipe; top rail not less than $1\frac{1}{4}$ x $1\frac{1}{4}$ x $\frac{1}{4}$ inch angle or equivalent; center rail not less than $1\frac{1}{4}$ x $5/16$ flat bar or equivalent. All connections shall be such as to make the railing stiff; 2 bolts ($\frac{3}{8}$ inch or larger) shall be used at the foot of each post wherever possible, or at least one $\frac{1}{2}$ inch bolt shall be used. Railing shall be continuous. No projections on the inside of the railing shall be permitted. Where a railing returns to the wall, it shall be fastened thereto with a through bolt (at least $\frac{3}{8}$ inch diameter), nut, and washer; or (in reinforced concrete) with an approved insert; or the railing shall be made equally secure with a diagonal brace extending at least 3 feet horizontally and 3 feet vertically.

(b) All outside railings which are more than 60 feet above grade shall be at least 6 feet high, measuring vertically from floor of platform or from nose of step. Such railings shall be of special design approved by the department, having not less than 4 longitudinal rails, and vertical lattice bars not more than 8 inches apart, and proper stiffening braces or brackets.

(9) **LADDER TO ROOF.** Every fire escape which extends higher than the second floor shall be provided with a ladder leading from the upper platform to the roof, unless the fire escape stairway leads to the roof. The ladder shall have stringers not less than 1¼ inch pipe, or not less than 2 x ¾ inch flat bars, at least 17 inches apart in the clear. The rungs shall be not less than ½ inch square or ¾ inch round bars, 14 inches center to center. The stringers shall be securely tied together at intervals no greater than every fifth rung. The stringers of each ladder shall extend not less than 4 feet above the roof coping and return to within 2 feet of the roof, with the top rung of the ladder level with the coping.

(10) **OTHER TYPES OF FIRE ESCAPES.** Sliding or chute fire escapes may be used, upon the approval of the department of industry, labor and human relations, in place of "A" or "B" fire escapes. Every sliding fire escape shall be provided with a ladder constructed as in sub. (9), extending from 5 feet above grade, to 4 feet above the roof coping.

History: 1-2-56; am. Register, December, 1962, No. 84, eff. 1-1-63; am. (1) (a), Register, February, 1971, No. 182, eff. 7-1-71; am. (7), Register, February, 1971, No. 182, eff. 3-1-71; r. and recr. 51.20 (1) (a) eff. 8-1-71 and exp. 1-1-72 and cr. (1) (a) eff. 1-1-72, Register, July, 1971, No. 187; am. (1) (a), Register, June, 1972, No. 198, eff. 7-1-72; am. (3) (intro. par.), Register, December, 1974, No. 228, eff. 1-1-75; am. (1) (a), Register, December, 1975, No. 240, eff. 1-1-76; am. (8) (intro.), Register, January, 1980, No. 289, eff. 2-1-80; am. (8) (b), Register, December, 1981, No. 312, eff. 1-1-82.

ILHR 51.21 Standpipe and hose systems. (1) GENERAL REQUIREMENTS. All required standpipe and hose systems shall meet the requirements of this section.

Note: The department will accept installations conforming to the latest edition of NFPA No. 14—Standard for Installation of Standpipe and Hose Systems.

(2) **CLASSES OF SERVICE.** (a) *Class I - Fire department standpipes.* For use by fire departments and those trained in handling heavy fire streams from a 2½-inch hose.

(b) *Class II - First-aid standpipes.* For use primarily by occupants of a building until the arrival of the fire department (1½-inch hose).

(c) *Class III - Combination fire department and first-aid standpipes.* For use by either fire departments and those trained in handling heavy hose streams or by the building occupants.

(d) *Dry standpipes.* For use by fire departments.

(3) **CLASS I - FIRE DEPARTMENT STANDPIPES.** (a) *Where required.* Fire department standpipes shall be provided for all buildings exceeding 60 feet in height.

1. Required standpipes shall be installed as construction progresses, to make them available for fire department use in the topmost floor constructed. Temporary standpipes may be provided in place of permanent standpipes during the period of construction when approved by the local fire department.

(b) *Number of standpipes.* Standpipes shall be sufficient in number so that any part of every floor area can be reached within 30 feet by a nozzle attached to 100 feet of hose connected to the standpipe in an unsprinklered building and 150 feet of hose in a sprinklered building.

(c) *Cross connections.* When 2 or more standpipes are required, they shall be cross connected and equipped with individual control valves. All control valves shall be of an approved indicating type valve. The valves shall be located so that the water supply to any standpipe riser can be shut off without interrupting the water supply to the remaining standpipes and be readily accessible to the fire department.

(d) *Location of outlets.* Hose outlets shall be located in stairway enclosures. Where stairways are not enclosed, outlets shall be at the inside of outside walls, within one foot of a smokeproof tower, interior stairway or fire escape. In buildings containing large interior areas, standpipes may be located at accessible interior locations.

(e) *Protection of standpipes.* Standpipes shall be protected against mechanical and fire damage. Dry standpipes shall be visible for inspection and not concealed.

Note: It is not the intent of this section to require standpipes to be protected with an hourly rated fire protection.

(f) *Size.* No required standpipe shall be less than 4 inches in diameter, and not less than 6 inches in diameter for standpipes in excess of 100 feet in height unless the building is completely sprinklered and the standpipe system is hydraulically designed in accordance with the requirements of sub. (6).

(g) *Hose valves and connections.* An approved 2½-inch hose-connection valve shall be located at each story, not less than 3 feet nor more than 6 feet above the floor level. Hose-connection valves shall be equipped with a tight-fitting cap on a chain and having lugs for a spanner wrench. When the building is completely sprinklered, and class II service is omitted, each standpipe outlet location shall be equipped with a 2½-inch hose valve, a 2½-inch by 1½-inch reducer, and a cap with an attached chain.

(h) *Hose threads.* All threads on hose connections shall be of national standard dimensions.

Note: Section 213.15, Stats., requires that all hose connections be fitted with the national standard hose threads adopted by the national fire protection association.

(i) *Fire department connection.* An approved fire department connection shall be installed on a 4-inch or larger pipe connection with each standpipe system. The connection shall be marked "Standpipe". If automatic fire sprinklers are also supplied by the hose connection, the sign shall read "Standpipe and Automatic Sprinkler". The elevation of the connection may be not less than 18 inches nor more than 42 inches above the sidewalk or ground. If municipal water is available at the building site, the fire department connection shall be located as close as possible to and within 150 feet of any fire hydrant.

(j) *Automatic water supply.* An automatic water supply for a wet standpipe system shall be designed to provide not less than the following capacity from top outlets at not less than 65 psi flowing pressure for a period of 30 minutes; 500 gpm for a single standpipe; 750 gpm for 2 inter-

connected standpipes; 1,000 gpm for larger systems. Any of the following supplies will be acceptable:

1. Public waterworks system where pressure and discharge capacity are adequate;
2. Approved automatic fire pump (or pumps);
3. Pressure tank;
4. Gravity tank;
5. Approved manually controlled fire pump operated by remote control devices at each hose outlet; or
6. Reservoirs.

(k) *Dry standpipes.* If only one standpipe is required, a dry standpipe may be used. A dry standpipe shall be limited to a single riser and shall not exceed 150 feet in height.

(4) CLASS II - FIRST-AID STANDPIPES. (a) *Where required.* First-aid standpipes shall be provided as required by the occupancy chapters of this code.

(b) *Number and location.* Standpipes shall be sufficient in number so that any part of every floor area, including basements, can be reached within 30 feet by a nozzle attached to not more than 100 feet of hose connected to a standpipe.

1. Hose outlets shall be located in occupied areas and preferably in corridors or at interior columns.

(c) *Size.* No required standpipe shall be less than 2 inches in diameter for buildings 4 or less stories or 50 feet in height, and not less than 2½ inches in diameter for buildings exceeding 4 stories or 50 feet in height.

(d) *Hose valves and connections.* An approved 1½-inch hose valve shall be located not more than 5 feet above the floor level. Where the static pressure at any standpipe hose outlet exceeds 100 psi, an approved device shall be installed at the outlet to reduce the pressure with the required flow at the outlet to not more than 100 psi.

(e) *Hoses.* Not more than 100 feet of hose shall be attached to each outlet. Hoses shall be of an approved type, 1½-inches in diameter, with ½-inch solid stream or combination nozzle attached, and shall be located in approved cabinets, racks or reels. In locations where the use of a solid stream may contribute to the spread of fire by scattering the burning material or where the existence of flammable liquids make the use of spray stream desirable, combination nozzles which give a spray or a solid stream shall be provided instead of ½-inch nozzles.

(f) *Water supply.* An automatic water supply shall be provided. The water supply shall be designed for 100 gpm for 30 minutes with 65 psi flowing pressure at the top outlet. The water supply may be from a city connection, gravity tank, pressure tank or pump.

Note #1: The department will permit the domestic water supply to service class II standpipes provided no intervening control valves are installed to interrupt the service of the standpipe and a check valve is installed to prevent contamination of the domestic water supply.

Note #2: The department will permit pumps, other than fire pumps, provided the water supply meets the requirements of sub. (4) (f).

Note #3: See ch. ILHR 82 for requirements pertaining to cross connections.

(5) **CLASS III — COMBINED FIRE DEPARTMENT AND FIRST-AID STANDPIPES.** (a) *Where permitted.* The features of class I and II service may be combined in a single system if served by an acceptable automatic water supply conforming to the requirements of sub. (3) (j).

(b) *Requirements.* Class III standpipes shall conform to the requirements of class I service except that 1½-inch outlets with a hose and 2½-inch outlets shall be provided on each floor and shall be installed to the requirements of the respective classes of service.

(6) **DRY STANDPIPES.** (a) *Where required.* Dry standpipes shall be provided as required by chs. ILHR 54 to 62.

Note: See ss. ILHR 54.15, 55.33, 56.20, 57.15 and 62.30.

(b) *Number and location.* Required dry standpipes shall be provided in each stair enclosure.

(c) *Hose valves and connections.* 1. Required dry standpipes shall be provided with approved 2½ inch valve hose connections at each floor level with one connection in the stair tower and one immediately outside.

2. Required dry standpipes with a fire department siamese connection greater than 50 feet to a street shall be interconnected to a standpipe system with the connection 50 feet or less to a street.

(d) *Miscellaneous requirements.* Dry standpipes shall conform to the requirements specified in sub. (3) (e) to (i).

(7) **COMBINED AUTOMATIC SPRINKLER AND STANDPIPE SYSTEM.** (a) *Definition.* A combined system is a system where the vertical water piping serves both the automatic sprinkler system and the 2½-inch hose outlets of the standpipes used by the fire department. The combined system shall comply with the automatic sprinkler requirements of s. ILHR 51.23 and the standpipe and hose requirements of s. ILHR 51.21.

(b) *Water supply and riser size.* The minimum water supply and riser size for a combined system shall comply with the requirements of sub. (3) (f) and (j), except the minimum water supply for a combined system for a completely sprinklered, light hazard occupancy building shall be 500 gallons per minute. When the building is completely sprinklered, the risers may be sized by hydraulic calculations.

Note: NFPA No. 13—Standard for Installation of Sprinkler Systems, defines light hazard occupancy as occupancies where the quantity and/or combustibility is low and fires with relatively low rates of heat release are expected, such as: churches; clubs; educational; hospitals; institutional; libraries, except large stack rooms; museums; nursing or convalescent homes; offices, including data processing; residential; restaurant seating areas; theaters and auditoriums, excluding stages and prosceniums.

(c) *Connections.* Each connection from a vertical riser of a combined system shall be provided with an individual control valve of the same size as the outlet.

FP

(8) **MAINTENANCE.** Standpipe systems and equipment, whether required by this code or not, shall be maintained in an operable condition.

History: 1-2-56; r. and rec. Register, December, 1976, No. 252, eff. 1-1-77; am. (7), Register, December, 1978, No. 276, eff. 1-1-79; am. (3) (i), Register, June, 1983, No. 330, eff. 7-1-83; emerg. renum. (6) and (7) to be (7) and (8), cr. (2) (d) and (6), eff. 9-6-86; renum. (6) and (7) to be (7) and (8), cr. (2) (d) and (6), Register, November, 1986, No. 371, eff. 12-1-86.

ILHR 51.22* Fire extinguishers. (1) **GENERAL.** All required fire extinguishers shall be approved by the department, and shall comply with the provisions of NFPA No. 10-1981 — Standard for Portable Fire Extinguishers.

(2) **INSTALLATION.** Fire extinguishers as specified in chs. ILHR 54-62 shall be installed as specified in NFPA No. 10-1981 — Standard for Portable Fire Extinguishers.

(3) **MAINTENANCE.** All portable fire extinguishers, whether required by chs. ILHR 54-62 or not, shall be maintained in operable condition as specified in NFPA No. 10-1981 — Standard for Portable Fire Extinguishers.

History: 1-1-56; am. Register, October, 1967, No. 142, eff. 11-1-67; r. and rec. Register, December, 1981, No. 312, eff. 1-1-82; am. Register, December, 1983, No. 336, eff. 1-1-84.

ILHR 51.23 Automatic sprinklers. (1) **GENERAL REQUIREMENTS.** (a) Except as permitted in chs. ILHR 54 to 62, all automatic fire sprinkler systems shall be designed and installed in accordance with NFPA No. 13, Standard for the Installation of Sprinkler Systems.

(b) The sprinkler system shall be so installed and maintained as to provide complete coverage for all portions of the building.

Note: See ch. Ind 4 for requirements pertaining to automatic fire sprinkler system protection for elevators.

(c) Reinstallation of used sprinkler heads shall be prohibited.

(d) Approved secondhand devices other than sprinkler heads may be installed by special permission of the department.

Note: The department will accept equipment, materials and devices listed or labeled by Underwriters' Laboratories or approved by Factory Mutual. Other testing laboratories or inspection agencies will be recognized as an approved agency if accepted in writing by the department.

(2) **WATER SUPPLY.** (a) Approved automatic water supplies for the sprinkler system recognized by the department are listed below:

1. City water main;

2. Gravity or pressure tank;

3. Ground storage reservoir; or

4. Natural bodies of water approved by the department (lakes, rivers, streams, etc.).

(b) If the water supply has inadequate pressure, an approved fire pump or tank shall be provided. The design and installation of water supply facilities for gravity tanks, fire pumps, reservoirs or pressure tanks, and underground piping shall conform to NFPA No. 22, Standard

*See Appendix A for further explanatory material.

for Water Tanks for Private Fire Protection; NFPA No. 20, Installation of Centrifugal Fire Pumps; and NFPA No. 24, Outside Protection.

(3) **BASEMENT SPRINKLERS.** Every basement sprinkler system shall also include sprinklers in all shafts (except elevator shafts) leading to the story above.

(4) **FIRE DEPARTMENT CONNECTION.** Except as provided in s. ILHR 57.016 (1) (a), every automatic fire sprinkler system installed in accordance with NFPA No. 13 shall have an approved fire department connection as specified in NFPA 13-1980. The connection shall be marked "Sprinkler". If standpipes are also supplied by the hose connection, the sign shall read "Standpipe and Automatic Sprinkler". The elevation of the connection shall be not less than 18 inches nor more than 42 inches above the sidewalk or ground. If municipal water is available at the building site, the fire department connection shall be located within 150 feet of a municipal fire hydrant.

(5) **SPRINKLER ALARMS.** Every sprinkler system shall be provided with a suitable audible alarm. In all buildings over 60 feet in height, each sprinkler system on each floor shall be equipped with a separate water flow device connected to an alarm system.

(6) **MAINTENANCE.** (a) All installed automatic sprinkler systems, whether required by this code or not, shall be properly maintained for efficient service pursuant to NFPA No. 13A — Standard for the Care Inspection Testing and Maintenance of Sprinkler Systems. Owners or operators shall be responsible for the condition of their sprinkler system and shall use due diligence in keeping the system in good operating condition. A copy of the inspection report as specified in NFPA No. 13A shall be kept and shall be made available, upon request, to the department or its authorized deputies. The local fire department shall be notified whenever the automatic fire sprinkler system is shut down or impaired and when it is placed back in service. The owner shall arrange for immediate and continual servicing or repair of the automatic fire sprinkler system until it is placed back in operation.

(b) The requirements of par. (a) shall apply to all buildings in existence on the effective date of this section and to those buildings constructed thereafter.

Note: See ss. ILHR 81.10 (6) and 81.11 (9) and s. 145.165, Stats., for additional requirements pertaining to maintenance and repair of automatic fire sprinkler systems.

(7) **PARTIAL AUTOMATIC FIRE SPRINKLER SYSTEMS.** Partial automatic fire sprinkler systems may be connected without a fire department connection to the domestic water supply service or a first-aid standpipe or a fire department standpipe provided the following conditions are satisfied:

(a) The number of sprinkler heads per building does not exceed 20;

(b) The connection is equipped with an approved indicating valve with a monitor or an approved locking device and a check valve;

(c) The water pressure and volume is adequate to supply the required flow of the largest number of sprinkler heads in any one of the enclosed areas; and

(d) An audible alarm is provided to sound when the system is in operation.

Note: See ch. ILHR 82 for requirements pertaining to cross connections.

(8) **SUBSTITUTE AUTOMATIC FIRE SUPPRESSION SYSTEMS.** When approved by the department, substitute automatic fire suppression systems may be used in lieu of an automatic fire sprinkler system in areas where the use of water could cause unusual damage to equipment, or where water may have a limited effect or may be hazardous to use because of the nature of processes involved.

(9) **SYSTEM SUPERVISION AND MONITORING.** The height limitations and fire resistive ratings in s. ILHR 51.02 (21) and (22) and the unlimited area buildings specified in chs. ILHR 54 to 62 shall be permitted only where the automatic fire sprinkler system is equipped with supervised sprinkler system valves or other approved component indicators, such as but not limited to fire pump power indicator or low water level indicator. The supervision function of the automatic fire sprinkler system shall be monitored by a central station, remote, auxiliary or proprietary fire alarm system company.

History: 1-2-56; r. and recr. Register, December, 1974, No. 228, eff. 1-1-75; cr. (7) (a), Register, December, 1976, No. 252, eff. 1-1-77; am. (6), Register, December, 1981, No. 312, eff. 1-1-82; r. and recr. (1), (4), (6) and (7), cr. (8), Register, June, 1983, No. 330, eff. 7-1-83; am. (6), Register, December, 1983, No. 336, eff. 1-1-84; emerg. am. (1) (a), (4) and (6) (a), cr. (9), eff. 9-6-86; am. (1) (a), (4) and (6) (a), cr. (9), Register, November, 1986, No. 371, eff. 12-1-86.

ILHR 51.24 Fire alarm systems. Interior fire alarm systems required under ss. ILHR 54.17, 56.19 and 57.17 shall be designed and constructed in conformity with the following requirements:

(1) All such alarm systems shall consist of operating stations on each floor of the building, including the basement, with bells, horns, or other approved sounding devices which are effective throughout the building. The system shall be so arranged that the operation of any one station will actuate all alarm devices connected to the system except in the case of a presignal system. Fire alarms shall be readily distinguishable from any other signalling devices used in the building. A system designed for fire alarm and paging service may be used if the design is such that fire alarm signals will have precedence over all others;

(a) In all buildings where a fire alarm system and a complete automatic sprinkler system are required, a water flow detecting device shall be provided to actuate the fire alarm system.

(2) Every fire alarm system shall be electrically operated or activated by non-combustible, nontoxic gas. Electrically operated systems shall be operated on closed circuit current under constant electrical supervision, so arranged that upon a circuit opening and remaining open or in case of a ground or short circuit in the undergrounded conductor, audible trouble signals will be given instantly. Gas-activated systems shall be mechanically supervised and under constant gas pressure, so arranged that in case of a pressure drop an audible trouble signal will be given instantly. Means shall be provided for testing purposes;

(3) (a) Except as provided in par. (b), coded fire alarm systems shall be provided in buildings more than 3 stories in height and the systems shall be so arranged that the code transmitted shall indicate the location and story of the structure in which the signal originated.

(b) 1. The department shall approve non-coded continuous sounding fire alarm systems under constant automatic supervision in apartment buildings.

2. The department shall approve non-coded continuous or march time sounding fire alarm systems with electrically supervised annunciator panels that indicate the location and the story of the structure in which the signal originated.

3. The department shall approve fire alarm and communication systems for high rise construction as specified in s. ILHR 52.01 (2) (e).

(4) Operating stations shall be prominently located in an accessible position at all required exit doors and required exit stairways. Operating stations shall be of an approved type and shall be conspicuously identified. All such operating stations shall be of a type, which after being operated, will indicate that an alarm has been sent therefrom until reset by an authorized means, (Operating stations having a "Break Glass" panel will be acceptable. On coded systems having a device to permanently record the transmission of an alarm, "Open Door" type stations may be used). The fire alarm operating stations shall be mounted not less than 3 feet nor more than 4 feet above the finished floor as measured from the floor to the center of the box;

FP (5) All alarm systems shall be tested at least once a month and a record of the tests shall be kept;

(6) Existing fire alarm systems that are effective in operation will be accepted if approved by the department;

(7) The gas for operation of non-combustible, non-toxic gas activated fire alarm systems shall be supplied from approved pressure cylinders on the premises. The cylinders shall have sufficient capacity and pressure to properly operate all sounding devices connected to the system for a period of not less than 10 minutes. Cylinders shall be removed for recharging immediately after use and shall be replaced by fully charged cylinders;

(8) Spare cylinders shall be kept on the premises at all times for immediate replacement and separate cylinders for testing shall be incorporated in the system;

(9) Tubing in connection with non-combustible, non-toxic gas activated fire alarm systems shall be installed in rigid metal conduit, flexible metal conduit, or surface metal raceways where subject to mechanical injury. Non-corrosive metallic tubing not less than 3/16" in diameter which will withstand a bursting pressure of not less than 500 pounds per square inch shall be used. The maximum length of 3/16" tubing shall not exceed 300 feet between charged cylinders. All tubing and other component parts shall be installed by skilled workers in accordance with the provisions of this code; and

Note: See Wisconsin State Electrical Code, Volume 2, ch. ILHR 16.

FP (10) **MAINTENANCE.** All fire alarm systems, whether required by this code or not, shall be maintained in an operable condition.

History: 1-2-56; am. (4) (a), Register, November, 1963, No. 95, eff. 12-1-63; am. Register, August, 1964, No. 104, eff. 9-1-64; r. (10), (11) and (12), Register, December, 1975, No. 240, eff. 1-1-76; cr. (1) (a) and am. intro. and (2), Register, December, 1976, No. 252, eff. 1-1-77; am. (intro.) and (4), r. (3) (a), Register, January, 1980, No. 289, eff. 2-1-80; am. (3) and (6), cr. (10), Register, December, 1981, No. 312, eff. 1-1-82; am. (5), Register, August, 1985, No. Register, April, 1990, No. 412

356, eff. 1-1-86; emerg. r. and recr. (3), eff. 9-6-86; r. and recr. (3), Register, November, 1986, No. 371, eff. 12-1-86.

ILHR 51.245 Smoke detectors. (1) **GENERAL REQUIREMENTS.** All required smoke detectors shall be approved by the department and shall comply with the provisions of NFPA No. 72E-1982 — Standard on Automatic Fire Detectors or NFPA No. 74-1980 — Household Fire Warning Equipment.

(2) **INSTALLATION.** (a) Smoke detectors and smoke detector systems shall be installed in accordance with the provisions of NFPA No. 72E-1982 — Standard on Automatic Fire Detectors or NFPA No. 74-1980 — Household Fire Warning Equipment and in accordance with the manufacturer's directions and specifications.

(b) Except as provided in s. ILHR 57.16 (2) (b), all smoke detectors interconnected with each other or with the manual fire alarm system shall be installed in accordance with the provisions of NFPA No. 72A-1979 — Standard for the Installation, Maintenance and Use of Local Protective Signaling Systems for Guard's Tour, Fire Alarm and Supervisory Service. Where smoke detectors are interconnected with the manual fire alarm system, the smoke detectors shall be wired in accordance with the provisions specified in s. ILHR 16.34.

(3) **MAINTENANCE.** Smoke detectors shall be maintained as follows, except as noted in s. ILHR 57.16:

(a) The owner shall be responsible for maintaining the smoke detectors and the smoke detection system in good working order;

(b) Tenants shall be responsible for informing the owner, in writing, of any smoke detector malfunction, including the need for a new battery;

(c) The owner shall have 5 days upon receipt of notice from the tenant to repair or replace the smoke detector or replace the battery; and

(d) The owner shall furnish to the tenant written notice of the responsibilities of the tenant and the obligations of the owner regarding smoke detector maintenance.

History: Cr. Register, December, 1981, No. 312, eff. 1-1-82; am. (2) and (3) (c), Register, October, 1982, No. 322, eff. 11-1-82; am. (1) and (2) (a), Register, December, 1983, No. 336, eff. 1-1-84; r. and recr. (3), Register, April, 1990, No. 412, eff. 5-1-90.

ILHR 51.25 Adoption of ASTM standards. Pursuant to s. 227.025, Stats., the attorney general and the revisor of statutes have consented to the incorporation by reference of the following standards of the American Society of Testing and Materials (ASTM), 1916 Race Street, Philadelphia, PA 19103. Copies of the standards in reference are on file in the

offices of the department, the secretary of state, and the revisor of statutes.

(1) GENERAL REQUIREMENTS FOR ROLLED STEEL PLATES, SHAPES, SHEET PILING AND BARS FOR STRUCTURAL USE. ASTM Designation A6-83.

(2) STRUCTURAL STEEL. ASTM Designation A36-81a.

(3) COLD-DRAWN STEEL WIRE FOR CONCRETE REINFORCEMENT. ASTM Designation A82-79.

(4) ZINC-COATED (GALVANIZED) STEEL WOVEN WIRE FENCE FABRIC. ASTM Designation A116-81.

(5) ZINC COATING (HOT-DIP) ON IRON AND STEEL HARDWARE. ASTM Designation A153-82.

(6) DEFORMED AND PLAIN BILLET-STEEL BARS FOR CONCRETE REINFORCEMENT. ASTM Designation A615-82.

(7) RAIL-STEEL DEFORMED AND PLAIN BARS FOR CONCRETE REINFORCEMENT. ASTM Designation A616-82a.

(8) AXLE-STEEL DEFORMED AND PLAIN BARS FOR CONCRETE REINFORCEMENT. ASTM Designation A617-82a.

(9) GYPSUM. ASTM Designation C22-77.

(10) CHEMICAL ANALYSIS OF LIMESTONE, QUICKLIME, AND HYDRATED LIME. ASTM Designation C25-83.

(11) STRUCTURAL CLAY LOAD-BEARING WALL TILE. ASTM Designation C34-62 (1975).

(12) COMPRESSIVE STRENGTH OF CYLINDRICAL CONCRETE SPECIMENS. ASTM Designation C39-81.

(13) OBTAINING AND TESTING DRILLED CORES AND SAWED BEAMS OF CONCRETE. ASTM Designation C42-82.

(14) SAMPLING, INSPECTION, PACKING, AND MARKING OF LIME AND LIMESTONE PRODUCTS. ASTM Designation C50-78 (1983).

(15) GYPSUM PARTITION TILE OR BLOCK. ASTM Designation C52-54 (1977).

(16) CONCRETE BUILDING BRICK. ASTM Designation C55-75 (1980).

(17) STRUCTURAL CLAY NON-LOAD-BEARING TILE. ASTM Designation C56-71 (1981).

(18) STRUCTURAL CLAY FLOOR TILE. ASTM Designation C57-57 (1978).

(19) BUILDING BRICK (SOLID MASONRY UNITS MADE FROM CLAY OR SHALE). ASTM Designation C62-81.

(19a) REFRACTORIES FOR INCINERATORS AND BOILERS. ASTM Designation C64-72 (1977).

(20) SAMPLING AND TESTING BRICK AND STRUCTURAL CLAY TILE. ASTM Designation C67-81.

(21) HOLLOW LOAD-BEARING CONCRETE MASONRY UNITS. ASTM Designation C90-75 (1981).

(22) MASONRY CEMENT. ASTM Designation C91-83a.

(23) ABSORPTION AND BULK SPECIFIC GRAVITY OF NATURAL BUILDING STONE. ASTM Designation C97-47 (1982).

(24) MODULUS OF RUPTURE OF NATURAL BUILDING STONE. ASTM Designation C99-52 (1981).

(24a) GROUND FIRE CLAY AS A REFRACTORY MORTAR FOR LAYING-UP FIRECLAY BRICK. ASTM Designation C105-47 (1981).

(25) PHYSICAL TESTING OF QUICKLIME, HYDRATED LIME, AND LIMESTONE. ASTM Designation C110-76a.

(28) SAMPLING AND TESTING CONCRETE MASONRY UNITS. ASTM Designation C140-75 (1980).

(29) AGGREGATE FOR MASONRY MORTAR. ASTM Designation C144-81.

(30) SOLID LOAD-BEARING CONCRETE MASONRY UNITS. ASTM Designation C145-75 (1981).

(31) PORTLAND CEMENT. ASTM Designation C150-83a.

(32) COMPRESSIVE STRENGTH OF NATURAL BUILDING STONE. ASTM Designation C170-50 (1981).

(33) HYDRATED LIME FOR MASONRY PURPOSES. ASTM Designation C207-79.

(34) MORTAR FOR UNIT MASONRY. ASTM Designation C270-82.

(35) GYPSUM CONCRETE. ASTM Designation C317-76 (1981).

(36) MICROSCOPICAL DETERMINATION OF AIR-VOID CONTENT AND PARAMETERS OF THE AIR-VOID SYSTEM IN HARDENED CONCRETE. ASTM Designation C457-82a.

(37) CHEMICAL ANALYSIS OF GYPSUM AND GYPSUM PRODUCTS. ASTM Designation C471-76.

(38) PHYSICAL TESTING OF GYPSUM PLASTERS AND GYPSUM CONCRETE. ASTM Designation C472-79.

(39) PHYSICAL TESTING OF GYPSUM BOARD PRODUCTS, GYPSUM LATH, GYPSUM PARTITION TILE OR BLOCK, AND PRECAST REINFORCED GYPSUM SLABS. ASTM Designation C473-81.

(40) MORTAR AND GROUT FOR REINFORCED MASONRY. ASTM Designation C476-80.

(41) HOLLOW BRICK (HOLLOW MASONRY UNITS MADE FROM CLAY OR SHALE). ASTM Designation C652-81a.

(42) TEST FOR RESISTANCE OF CONCRETE TO RAPID FREEZING AND THAWING. ASTM Designation C666-80.

(42a) TEST METHOD FOR BOND STRENGTH OF MORTAR TO MASONRY UNITS. ASTM Designation C952-76.

(43) ESTABLISHING STRUCTURAL GRADES AND RELATED ALLOWABLE PROPERTIES FOR VISUALLY GRADED LUMBER. ASTM Designation D245-81.

(43a) RATE OF BURNING AND/OR EXTENT AND TIME OF BURNING OF SELF-SUPPORTING PLASTICS IN A HORIZONTAL POSITION. ASTM Designation D635-81.

(44) EVALUATING THE PROPERTIES OF WOOD-BASE FIBER AND PARTICLE PANEL MATERIALS. ASTM Designation D1037-78.

(45) TESTING PILES UNDER AXIAL COMPRESSIVE LOAD. ASTM Designation D1143-81.

(45a) IGNITION PROPERTIES OF PLASTICS. ASTM Designation D1929-77.

(45b) DENSITY OF SMOKE FROM THE BURNING OR DECOMPOSITION OF PLASTICS. ASTM Designation D2843-77.

(46) CONDUCTING STRENGTH TESTS OF PANELS FOR BUILDING CONSTRUCTION. ASTM Designation E72-80.

(47) TEST FOR SURFACE BURNING CHARACTERISTICS OF BUILDING MATERIALS. ASTM Designation E84-81a.

(48) FIRE TESTS OF ROOF COVERINGS. ASTM Designation E108-83.

(49) FIRE TESTS OF BUILDING CONSTRUCTION AND MATERIALS. ASTM Designation E119-83.

(50) TEST FOR BEHAVIOR OF MATERIALS IN A VERTICAL TUBE FURNACE AT 750° C. ASTM Designation E136-82.

(51) FIRE TESTS OF DOOR ASSEMBLIES. ASTM Designation E152-81a.

(52) FIRE TESTS OF WINDOW ASSEMBLIES. ASTM Designation E163-80.

(53) TEST FOR RATE OF AIR LEAKAGE THROUGH EXTERIOR WINDOWS, CURTAIN WALLS AND DOORS. ASTM Designation E283-83.

(54) TESTS FOR COMPRESSIVE STRENGTH OF MASONRY PRISMS. ASTM Designation E447-80.

(55) TEST FOR CRITICAL RADIANT FLUX OF FLOOR COVERING SYSTEMS USING A RADIANT HEAT SOURCE. ASTM Designation E648-78.

History: Cr. Register, October, 1967, No. 142, eff. 11-1-67; cr. (88) to (93), Register, February, 1971, No. 182, eff. 7-1-71; r. (88) to (93) eff. 8-1-71 and rec. (88) to (93) eff. 1-1-72, Register, July, 1971, No. 187; r. and rec., Register, July, 1974, No. 223, eff. 1-1-75; am. (43), Register, December, 1978, No. 276, eff. 1-1-79; cr. (55), Register, May, 1980, No. 293, eff. 6-1-80; am. Register, December, 1981, No. 312, eff. 1-1-82; cr. (43a), (45a) and (45b), am. (47), Register, December, 1983, No. 336, eff. 1-1-84; am. Register, August, 1985, No. 356, eff. 1-1-86.

ILHR 51.26 Adoption of ACI Standards. Pursuant to s. 227.025, Stats., the attorney general and the revisor of statutes have consented to the incorporation by reference of the following standards of the American Concrete Institute (ACI), P. O. Box 19150, Detroit, Michigan 48219. Copies of the standards in reference are on file in the offices of the department, the secretary of state, and the revisor of statutes.

(1) BUILDING CODE REQUIREMENTS FOR REINFORCED CONCRETE. ACI 318-83.

History: Cr. Register, October, 1967, No. 142, eff. 11-1-67; r. and rec., Register, July, 1974, No. 223, eff. 1-1-75; am. (intro.) and (1), Register, January, 1980, No. 289, eff. 2-1-80; r. (2) and (3), Register, December, 1981, No. 312, eff. 1-1-82; am. (1), Register, August, 1985, No. 356, eff. 1-1-86.

ILHR 51.27 Adoption of miscellaneous standards. Pursuant to s. 227.025, Stats., the attorney general and the revisor of statutes have consented to the incorporation by reference of the following standards. Copies of the standards in reference are on file in the offices of the department, the secretary of state, and the revisor of statutes.

(1) Aluminum Association, 818 Connecticut Avenue, N.W., Washington, DC 20006. SPECIFICATIONS FOR ALUMINUM STRUCTURES, Aluminum Construction Manual, Section 1, third edition, April, 1976.

(2) American Institute of Steel Construction, 400 North Michigan Ave., Chicago, Illinois 60611, SPECIFICATION FOR THE DESIGN, FABRICATION AND ERECTION OF STRUCTURAL STEEL FOR BUILDINGS, November 1, 1978; and COMMENTARY ON THE SPECIFICATIONS FOR THE DESIGN, FABRICATION AND ERECTION OF STRUCTURAL STEEL FOR BUILDINGS, November 1, 1978.

(3) American Institute of Timber Construction, 333 West Hampden Ave., Englewood, Colorado 80110, STANDARD SPECIFICATIONS FOR STRUCTURAL GLUED LAMINATED TIMBER OF SOFTWOOD SPECIES, AITC 117-79 — DESIGN; STANDARD SPECIFICATIONS FOR HARDWOOD GLUED LAMINATED TIMBER, AITC 119-76.

(4) American Iron and Steel Institute, 1000 16th St., NW, Washington, DC 20036, SPECIFICATION FOR THE DESIGN OF COLD-FORMED STEEL STRUCTURAL MEMBERS, September 3, 1980, edition; STAINLESS STEEL COLD-FORMED STRUCTURAL DESIGN MANUAL 1974 edition; MANUAL FOR STRUCTURAL APPLICATIONS OF STEEL CABLES FOR BUILDINGS, 1973 edition.

(5) American National Standards Institute, Inc., 1430 Broadway, New York, NY 10018, SPECIFICATION FOR REINFORCED GYP Register, August, 1985, No. 356

SUM CONCRETE, ANSI A59.1-1968 (R-1972); SPECIFICATION FOR VERMICULITE CONCRETE ROOFS AND SLABS ON GRADE, ANSI A122.1-1965; DIRECT GAS-FIRED MAKE-UP AIR HEATERS, ANSI Z83.4-1980; PERFORMANCE SPECIFICATIONS AND METHODS OF TESTING FOR SAFETY GLAZING MATERIALS USED IN BUILDINGS, ANSI Z97.1-1975.

(6) American Welding Society, P.O. Box 351040, Miami, Florida 33135, STRUCTURAL WELDING CODE-STEEL, AWS D1.1-84; STRUCTURAL WELDING CODE-SHEET STEEL, AWS D1.3-81.

(6a) American Wood Preservers Bureau, 2772 S. Randolph St., P.O. Box 6085, Arlington, Virginia 22206, STANDARD FOR SOFTWOOD LUMBER, TIMBER AND PLYWOOD PRESSURE TREATED WITH WATER-BORNE PRESERVATIVES FOR ABOVE GROUND USE, AWPB standard LP-2, 1980; STANDARD FOR SOFTWOOD LUMBER, TIMBER AND PLYWOOD PRESSURE TREATED WITH WATER-BORNE PRESERVATIVES FOR GROUND CONTACT USE, AWPB standard LP-22, 1980; QUALITY CONTROL PROGRAM FOR SOFTWOOD LUMBER, TIMBER AND PLYWOOD PRESSURE TREATED WITH WATER-BORNE PRESERVATIVES FOR GROUND CONTACT USE IN RESIDENTIAL AND LIGHT COMMERCIAL FOUNDATIONS, AWPB standard FDN, 1980.

(7) National Fire Protection Association, Batterymarch Park, Quincy, Mass. 02269;

(a) STANDARD FOR PORTABLE FIRE EXTINGUISHERS, NFPA No. 10-1984;

(b) STANDARD FOR THE INSTALLATION OF SPRINKLER SYSTEMS, NFPA No. 13-1985;

(c) STANDARD FOR THE INSPECTION, TESTING AND MAINTENANCE OF SPRINKLER SYSTEMS, NFPA No. 13A-1981;

(cm) STANDARD FOR SPRINKLER SYSTEMS IN ONE- AND TWO-FAMILY DWELLINGS AND MOBILE HOMES, NFPA No. 13D-1984;

(d) STANDARD FOR THE INSTALLATION OF CENTRIFUGAL FIRE PUMPS, NFPA No. 20-1983;

(e) STANDARD FOR WATER TANKS FOR PRIVATE FIRE PROTECTION, NFPA No. 22-1984;

(f) STANDARD FOR INSTALLATION OF PRIVATE FIRE SERVICE MAINS, NFPA No. 24-1984;

(g) STANDARD FOR THE INSTALLATION OF OIL-BURNING EQUIPMENT, NFPA No. 31-1983;

(h) NATIONAL FUEL GAS CODE, NFPA No. 54-1984;

(i) STANDARD FOR CENTRAL STATION PROTECTIVE SIGNALING SYSTEMS, NFPA No. 71-1982;

(j) STANDARD FOR THE INSTALLATION, MAINTENANCE AND USE OF LOCAL PROTECTIVE SIGNALING SYSTEMS FOR

GUARD'S TOUR, FIRE ALARM AND SUPERVISORY SERVICE, NFPA No. 72A-1979;

(k) STANDARD FOR AUXILIARY PROTECTIVE SIGNALING SYSTEMS, NFPA No. 72B-1979;

(l) STANDARD FOR REMOTE STATION PROTECTIVE SIGNALING SYSTEMS, NFPA No. 72C-1982;

(m) STANDARD FOR PROPRIETARY PROTECTIVE SIGNALING SYSTEMS, NFPA No. 72D-1979;

(n) STANDARD ON AUTOMATIC FIRE DETECTORS, NFPA No. 72E-1982;

(o) STANDARD FOR HOUSEHOLD FIRE WARNING EQUIPMENT, NFPA No. 74-1984;

(p) STANDARD FOR THE INSTALLATION OF AIR CONDITIONING AND VENTILATING SYSTEMS, NFPA No. 90A-1981;

(q) STANDARD FOR CHIMNEYS, FIREPLACES, VENTS AND SOLID FUEL BURNING APPLIANCES, NFPA No. 211-1984.

(r) STANDARD FOR GENERAL STORAGE, NFPA No. 231-1985; and

(s) STANDARD FOR RACK STORAGE OF MATERIALS, NFPA No. 231C-1980.

(8) National Forest Products Association, 1619 Massachusetts Ave. NW, Washington, D.C. 20036, NATIONAL DESIGN SPECIFICATION FOR WOOD CONSTRUCTION, 1982 edition, with amendments to sections 2.2.5.3, 4.1.7 and 4.2.2, including DESIGN VALUES FOR WOOD CONSTRUCTION, a March, 1982 supplement to the 1982 edition of National Design Specification for Wood Construction; THE ALL-WEATHER WOOD FOUNDATION SYSTEM, BASIC REQUIREMENTS, Technical Report No. 7, Revised March, 1982, with amendments to Article 3.3.1 of section 3.3.

(9) Steel Joist Institute, Suite A, 1205 48th Ave. North, Myrtle Beach, South Carolina 29577, STANDARD SPECIFICATIONS, LOAD TABLES AND WEIGHT TABLES FOR STEEL JOISTS AND JOIST GIRDERS, 1984.

(10) Truss Plate Institute, Inc., 583 D'onofrio Dr., Suite 200, Madison, Wisconsin 53719, DESIGN SPECIFICATION FOR METAL PLATE CONNECTED WOOD TRUSSES, TPI-85.

(11) American Plywood Association, 7011 South 19th Street, Tacoma, Washington 98460, U.S. PRODUCT STANDARD FOR CONSTRUCTION AND INDUSTRIAL PLYWOOD, PS 1-74.

(12) Superintendent of Documents, U.S. Government Printing Office, Washington, DC 20402, GUIDELINES FOR CONSTRUCTION AND EQUIPMENT FOR HOSPITALS AND MEDICAL FACILITIES, DHHS PUBLICATION No. (HRS-M-HF) 84-1.

(14) American Society of Heating, Refrigerating and Air Conditioning Engineers, 1791 Tullie Circle NE, Atlanta, Georgia 30329, HANDBOOK OF FUNDAMENTALS, 1977; METHODS OF TESTING

AIR-CLEANING DEVICES USED IN GENERAL VENTILATION FOR REMOVING PARTICULATE MATTER, ASHRAE STANDARD No. 52-76.

(15) Underwriters' Laboratories, Inc., 333 Pfingsten Road, Northbrook, Illinois 60062, **FACTORY-MADE AIR DUCTS AND CONNECTORS, UL STANDARD No. 181-1981**, sixth edition including revisions dated March 19, 1984; **OUTLINE OF INVESTIGATION FOR ROOF DECK CONSTRUCTION, UL No. 1256, June 15, 1979.**

(16) Factory Mutual, Inc., 1151 Boston-Providence Turnpike, Norwood, Mass. 02062, **APPROVAL STANDARD FOR CLASS I INSULATED STEEL DECK ROOFS, FM Standard 4450, Revised August 5, 1977.**

History: Cr. Register, July, 1974, No. 223, eff. 1-1-75, am. (5) and (10), cr. (7a), Register, December, 1974, No. 228, eff. 1-1-75; am. (2) and r. (7), Register, December, 1976, No. 252, eff. 1-1-77; cr. (6a) and am. (8), Register, December, 1978, No. 276, eff. 1-1-79; am. (10), Register, February, 1979, No. 278, eff. 3-1-79; am. (2), (6), (7a), (9) and (10), Register, January, 1980, No. 289, eff. 2-1-80; am. (1) and (3) to (10), r. and recr. (11), cr. (12) to (15), Register, December, 1981, No. 312, eff. 1-1-82; cr. (12) to (16), Register, February, 1982, No. 314, eff. 3-1-82; am. (7a), Register, October, 1982, No. 322, eff. 11-1-82; am. (7a), Register, June, 1983, No. 330, eff. 7-1-83; am. (5), (7a) and (8), r. and recr. (15), cr. (16), Register, December, 1983, No. 336, eff. 1-1-84; am. (6), (9), (10), (12) and (15), renum. (7a) to be (7) and am., r. (13), Register, August, 1985, No. 356, eff. 1-1-86; emerg. am. (7) (b), (c) and (e), cr. (7) (cm), (r) and (s), r. and recr. (7) (f), eff. 9-6-86; am. (7) (b), (c) and (e), cr. (7) (cm), (r) and (s), r. and recr. (7) (f), Register, November, 1986, No. 371, eff. 12-1-86.

Chapter ILHR 52

GENERAL REQUIREMENTS

- Subchapter I — Fire Prevention, Detection and Suppression for High Rise Buildings**
- ILHR 52.01 Fire prevention, detection and suppression for high rise buildings (p. 103)
- Subchapter II — Automatic Fire Sprinkler Systems for Low Rise Buildings**
- ILHR 52.011 Purpose, scope and application (p. 107)
- ILHR 52.012 Individual room, limited area and partial automatic fire sprinkler systems (p. 109)
- ILHR 52.013 Specified applications by occupancy or use (p. 110)
- Subchapter III — Windows and Fire Department Access Openings**
- ILHR 52.02 Windows (p. 112)
- ILHR 52.03 Window cleaning (p. 112-1)
- Subchapter IV — Barrier-free Design for the Physically Disabled**
- ILHR 52.04 Requirements for barrier-free environments (p. 113)
- ILHR 52.041 Health care facilities — new construction (p. 126)
- ILHR 52.042 Existing health care facilities (p. 127)
- Subchapter V — Courts**
- ILHR 52.05 Size of courts (p. 127)
- ILHR 52.06 Ventilation of courts (p. 128)
- Subchapter VI — Atriums**
- ILHR 52.07 Atriums (p. 128)
- Subchapter VII — Miscellaneous Provisions**
- ILHR 52.19 Gas and oil lamps; gas service (p. 131)
- ILHR 52.20 Electrical work (p. 132)
- ILHR 52.21 Location and maintenance of exits (p. 132)
- ILHR 52.22 Repairs (p. 132)
- ILHR 52.23 Cleanliness (p. 132)
- Subchapter VIII — Sanitary Facilities**
- ILHR 52.50 Toilet rooms (p. 132)
- ILHR 52.52 Sex designation (p. 132)
- ILHR 52.53 Location, light and ventilation (p. 133)
- ILHR 52.54 Location without outside windows; when permitted (p. 133)
- ILHR 52.55 Artificial light (p. 133)
- ILHR 52.56 Size (p. 134)
- ILHR 52.57 Floor and base (p. 134)
- ILHR 52.58 Walls and ceilings (p. 134)
- ILHR 52.59 Enclosure of fixtures (p. 134)
- ILHR 52.60 Fixtures (p. 135)
- ILHR 52.61 Protection from freezing (p. 137)
- ILHR 52.62 Disposal of sewage (p. 137)
- ILHR 52.63 Outdoor toilets (p. 137)
- ILHR 52.64 Maintenance and housekeeping (p. 137)

Note: Chapter Ind 52 was renumbered to be Chapter ILHR 52 effective 1-1-84.

Subchapter I — Fire Prevention, Detection and Suppression for High Rise Buildings

ILHR 52.01 Fire prevention, detection and suppression for high rise buildings. (1) **AUTOMATIC FIRE SPRINKLER SYSTEM.** A complete automatic sprinkler system, as specified in s. ILHR 51.23, shall be provided in every building more than 60 feet in height, the initial construction of which is commenced after July 2, 1974. The requirements of this section shall not apply to open parking structures as defined in s. ILHR 62.10 (2).

(a) *Additions to existing buildings.* Building additions more than 60 feet in height shall have an automatic sprinkler system installed. The sprinkler protection shall be provided throughout the existing building unless the addition is separated from the existing building by a fire division wall as specified in s. ILHR 51.02 (13). The requirements of this section shall not apply to open parking structures as defined in s. ILHR 62.10 (2).

(b) *Substitute suppression systems.* When approved by the department, substitute automatic suppression systems may be used in lieu of a sprin-

kler system in areas where the use of water could cause unusual damage to equipment, or where water may have a limited effect or may be hazardous to use because of the nature of processes involved.

Note: The department will accept design and installation in accordance with the latest edition of the national fire protection association standards for special extinguishing systems.

(c) *Alternate methods.* When approved by the department, alternate methods of fire prevention, detection and suppression may be provided in lieu of a complete automatic sprinkler system.

Note #1: The department will request a position statement regarding the proposed method to be submitted by the fire chief of the municipality wherein the building is located.

Note #2: The department will consider alternate methods of fire prevention, detection and suppression to include, but not limited to, fire-resistive construction, compartmentation, automatic detection systems, interior finish restriction, and partial sprinkler protection.

(2) **ADDITIONAL REQUIREMENTS FOR HIGH-RISE BUILDINGS.** The following requirements apply to all buildings more than 100 feet in height or having more than 10 stories. Open parking structures and buildings used for low hazard industrial processes, including the production and distribution of gas, steam or electric power, foundries and similar uses which require unusual heights to accommodate cranes, special machinery or equipment, are exempt from the provisions of this subsection.

(a) *Smoke control.* Natural or mechanical ventilation for the removal of products of combustion shall be provided in every story and shall consist of one or more of the following methods. Controlling devices may be automatic or manual as approved by the local fire department.

1. Panels or windows in the exterior wall which can be opened from a location other than the fire floor. Such venting facilities shall be provided at the rate of at least 20 square feet per 50 lineal feet of exterior wall in each story, and distributed around the perimeter at not more than 50-foot intervals. Such panels shall be clearly identified as required by the fire department.

2. Openable windows in habitable rooms of residential units.

3. When an automatic sprinkler system is installed in compliance with s. ILHR 51.23, the mechanical air handling equipment may be designed to assist smoke removal. Under fire conditions, the return and exhaust air shall be taken directly to the outside without recirculation to other sections of the building.

4. A mechanical ventilation system which will prevent the transfer of smoke from the fire source to other floors of the building. The design shall be substantiated by calculations or tests showing that a pressure differential of 0.10 inch of water column will be produced.

5. Any other design which will produce equivalent results.

(b) *Exit stairways.* 1. All stairways shall be pressurized. The pressure across each door shall be at least 0.15 but not more than 0.20 inch of water column with all doors closed. Pressurization shall be activated by the fire alarm system, the detection systems, and the sprinkler system. In lieu of pressurization, a smokeproof stair tower, as defined in s. ILHR 51.17, will be accepted.

Note: The department will accept alternate designs which will produce equivalent results.

2. All stairway doors which are to be locked from the stairway side shall have the capability of being unlocked without unlatching upon a signal from the central control station.

(c) *Elevators.* There shall be provided at least one elevator suitable for fire department access to any floor. If the building is not provided with an approved automatic sprinkler system, the elevator lobby at each level shall be separated from the remainder of the building by an effective smoke barrier.

Note: Refer to ch. Ind 4 for additional requirements.

(d) *Fire alarm and detection system.* 1. A manual fire alarm box shall be located adjacent to exit doors into stairway shafts and in every elevator lobby.

2. An approved system which will provide for automatic detection of products of combustion other than heat shall be installed in every air-handling equipment room, unless sprinklered, and in the return air portion of every air conditioning and mechanical ventilation system. Approved heat detectors may be installed in boiler rooms and furnace rooms in lieu of product of combustion detectors.

a. Detectors shall be located in the main return air and supply air ducts of each ventilation system and at each opening into a vertical return air shaft or duct.

b. The detectors shall actuate an alarm or signaling system and shut down the ventilation system except where automatic smoke control is incorporated in the system.

3. The manual alarm and automatic detection system shall conform to the Wisconsin State Electrical Code, Volume 2, ch. ILHR 16 and one of the following standards:

a. Standard for Central Station Protective Signaling Systems, NFPA No. 71;

b. Standard for Auxiliary Protective Signaling Systems, NFPA No. 72B;

c. Standard for Remote Station Protective Signaling Systems, NFPA No. 72C;

d. Standard for Proprietary Protective Signaling Systems, NFPA No. 72D.

4. Detectors shall conform to the Standard for Automatic Fire Detectors, NFPA No. 72E.

(e) *Alarm and communication systems.* The following alarm and communication systems shall be provided. The systems shall be supervised and exposed wiring shall be encased in a metal conduit.

1. Voice alarm system. The detection system, sprinkler water flow device and the fire alarm system shall actuate a prerecorded message or voice alarm capable of being operated from the central control station on a general as well as a selective basis to the area involved. The alarm shall be designed to be heard by all occupants within the building or designated portions.

2. Voice communication system. There shall be a voice communication system between the central control station and the following areas:

Note: The department will accept systems installed in accordance with the Standard for the Installation, Maintenance and Use of Local Protective Signaling Systems for Watchmen, Fire Alarm and Supervisory Service, NFPA No. 72A.

a. Elevators, elevator lobbies, in stairways at every fifth floor, and all manual fire alarm boxes (2-way communication system);

b. Every office area exceeding 1,000 square feet in area (one-way address system); and

c. Each dwelling unit and hotel guest room (one-way address system).

3. Fire department communication system. A system providing 2-way communication shall be provided at all floor levels, stairways, the central control station, and other locations required by the fire department.

a. The system shall be designed so the fire department communication system will override the other communication systems.

b. Wiring shall be arranged so that open circuits or short circuits on individual floors will not interfere with communications on another floor.

4. Combined system. When approved by the local fire department, the fire department communication system may be combined with the voice communication system and the voice alarm system.

(f) *Central control station.* A central control station for fire department operations shall be provided in a location approved by the fire department. It shall contain the voice communication systems panel; fire detection and alarm system panels; status indicators and controls for elevators, smoke venting and air handling systems; controls for unlocking stairway doors; a public telephone; sprinkler valve and water flow detectors; and standby power controls. All fire alarm and water flow signals shall be transmitted directly to the systems indicated in s. ILHR 52.01 (2) (d) 3.

(g) *Standby power and light.* An approved permanently installed standby power generating system shall be provided. The system shall be equipped with suitable means for automatically starting the generator set upon failure of the normal electrical service and for automatic transfer and operation of the required electrical functions at full power within 60 seconds of such normal service failure. System supervision with manual start and transfer features shall be provided at the central control station.

1. An on-premise fuel supply sufficient for not less than 2 hours full demand operation of the system shall be provided.

2. The power requirement shall be determined so as to provide service to, but not limited to the following:

a. Fire alarm system;

b. Exit and other emergency lighting;

c. Fire protection equipment;

Note: Standby power to service fire pumps may be omitted if approved by the local fire department.

- d. Mechanical ventilation required by this section;
- e. Fire department elevator; and
- f. Communication systems.

(h) *Maintenance.* All communication, fire prevention, detection and suppression systems required under this section shall be tested and maintained in an operable condition. All installed automatic sprinkler systems shall be maintained pursuant to NFPA No. 13A — Standard for the Inspection, Testing and Maintenance of Sprinkler Systems. A copy of the test report as specified in NFPA No. 13A shall be kept and shall be made available, upon request, to the department or its authorized deputies. The local fire department shall be notified whenever the life safety systems are shut down or impaired and when placed back in service. The owner shall arrange for immediate and continual servicing or repair of the communication, fire prevention, detection and suppression systems until they are placed back in operation.

(i) *Floor level identification.* Each floor level or story shall be identified as to its number or name. Identification signs shall be posted in all elevator lobbies and in all required exit stairways.

History: Emerg. cr. eff. 1-1-75; cr. (1), Register, April, 1975, No. 232, eff. 5-1-75; cr. (2), Register, April, 1975, No. 232, eff. 1-1-76; (2), eff. 1-1-77; am. (2), Register, December, 1976, No. 252, eff. 1-1-77; am. (2) (d) 2. a. and cr. (2) (i), Register, December, 1977, No. 264, eff. 1-1-78; am. (1) (intro.), (a), (2) (intro.) and (2) (e) 2. a., Register, December, 1978, No. 276, eff. 1-1-79; am. (2) (h), Register, December, 1981, No. 312, eff. 1-1-82; am. (2) (h), Register, June, 1983, No. 330, eff. 7-1-83; emerg. am. (2) (h), eff. 9-6-86; am. (2) (h), Register, November, 1986, No. 371, eff. 12-1-86.

Subchapter II — Automatic Fire Sprinkler Systems for Low Rise Buildings

ILHR 52.011 Purpose, scope and application. (1) **GENERAL.** Pursuant to s. 101.14 (4) (a), (c) and (g), Stats., created by 1983 Wisconsin Act 295, this subchapter establishes automatic fire sprinkler system requirements for buildings under 60 feet in height which are used as public buildings or places of employment.

(2) **GENERAL REQUIREMENT.** Except as provided in sub. (3), automatic fire sprinkler systems shall be installed in the rooms, areas, locations, and building occupancies as specified in ss. ILHR 52.012 and 52.013.

Note: Section 4-4.4.1 of NFPA 13 states: "All concealed spaces enclosed wholly or partially by exposed combustible construction shall be protected by sprinklers." The section also listed exceptions to the rule. Buildings "completely protected" by automatic fire sprinkler systems must comply with this and related sections of NFPA 13.

(3) **ALTERNATE METHODS.** When approved by the department through the petition for variance process, alternate methods of fire protection, detection or suppression providing an equivalent degree of life safety protection may be provided.

Note: See s. ILHR 50.25 for the procedure used for submitting a petition for variance to an administrative rule.

(4) **SYSTEM DEFINITION AND STANDARD.** The automatic fire sprinkler systems specified in this subchapter shall conform to the definition specified in s. ILHR 51.01 (7a) and shall comply with the requirements speci-

fied in standards listed in ss. ILHR 51.27 (7) (b), (c), (cm), (d), (e), (f), (r) and (s).

Note #1: The definition of the term "automatic fire sprinkler system" in s. ILHR 51.01 (7a) is taken from s. 145.01 (2), Stats.

Note #2: See s. A52.011 of Appendix A for additional information pertaining to fire hazard classifications, building usage, and occupancy.

(5) **AREA SEPARATION WALLS.** (a) Buildings having an area exceeding the area limitations specified in s. ILHR 52.013, may be constructed without complete automatic fire sprinkler systems provided the building is divided into areas less than the specified area limitations by at least 2-hour rated vertical fire separation walls. The fire separation wall shall extend from the foundation to the underside of the roof deck.

1. Structural framing members may continue through or over the separation wall provided the framing and supporting elements are of noncombustible or one-hour fire-resistive combustible construction.

2. All openings in the separation wall shall be protected by fire-resistive door assemblies as specified in s. ILHR 51.047.

(b) Where additions to buildings result in the area of the entire building exceeding the area limitations specified in s. ILHR 52.013, one of the following conditions shall apply:

1. The existing building and the building addition shall be completely protected by an automatic fire sprinkler system;

2. The building addition shall be separated from the existing building by a 2-hour rated vertical fire separation wall. If the area of the building addition exceeds the area limitations specified in s. ILHR 52.013, the building addition shall be completely protected by an automatic fire sprinkler system or the building addition shall be divided with 2-hour rated vertical fire separation walls as specified in par. (a); or

3. The existing building and the building addition shall be divided by 2-hour rated vertical fire separation walls as specified in par. (a).

(6) **MULTIPLE USE BUILDINGS.** Where a building contains multiple occupancies or use areas and one occupancy or use area is required by s. ILHR 52.013 to be protected by an automatic fire sprinkler system, one of the following conditions shall apply:

(a) The occupancy or use area protected by the automatic fire sprinkler system shall be separated from the unprotected areas by at least 1-hour fire-resistive rated construction; or

(b) The entire building shall be protected by an automatic fire sprinkler system.

Note: See ss. ILHR 55.05 and 59.22 for occupancy separation requirements mandating fire-resistive separations of more than 1-hour rating.

(7) **SEPARATION OF AREAS PROTECTED BY A PARTIAL AUTOMATIC FIRE SPRINKLER SYSTEM.** Where the provisions of ss. ILHR 52.012 require the protection of an automatic fire sprinkler system, the protected area or room shall be enclosed with construction assemblies as specified in chs.

ILHR 54 to 62 and as designated in Table 51.03-A for the class of construction.

Note: This rule is intended to require an effective fire barrier between those portions of the building protected by the automatic fire sprinkler system and the adjoining unprotected portions. The fire barrier is not required to be of fire-resistive construction unless required for the occupancy, use or class of construction.

History: Emerg. cr. eff. 9-6-86; cr. Register, November, 1986, No. 371, eff. 12-1-86.

ILHR 52.012 Individual room, limited area and partial automatic fire sprinkler systems. The rooms or areas within buildings as specified in subs. (1) to (5) shall be protected by an automatic fire sprinkler system.

(1) **WINDOWLESS FLOOR LEVELS.** (a) Except as provided in pars. (b) and (c), automatic fire sprinkler system protection shall be provided in all basements and floor levels where openings as specified in s. ILHR 52.02 (2) (a) are not provided.

(b) Automatic fire sprinkler system protection need not be provided in the following windowless floor level applications:

1. Windowless floor levels of 2500 square feet or less in total area and equipped with an approved smoke detection system which is:

a. Directly and permanently wired to a proper unswitched circuit; and

b. Interconnected to the building manual fire alarm system. If the building does not have a manual fire alarm system, the smoke detection system shall be capable of sounding an audible alarm which can be heard in all occupied areas of the building.

2. Communication equipment rooms separated from the remainder of the building by at least one-hour fire resistive construction and the room is equipped with an approved automatic fire detection and alarm system;

3. Windowless floor levels in ch. ILHR 54 occupancies classified as low hazard and not exceeding 3000 square feet in area;

4. Windowless floor levels within individual living units of ch. ILHR 57 Occupancies;

5. Interior balconies and open mezzanine floors; and

6. Windowless floor levels in hospitals and nursing homes.

Note: See chs. ILHR 58 and HSS 124 and 132 for additional requirements.

(c) One-story buildings with no floor levels below the first floor need not be provided with exterior wall openings other than the required exits. Except as provided in par. (b), enclosed mezzanine floor levels shall be protected by an automatic fire sprinkler system or provided with exterior wall openings.

(2) **LAUNDRY AND TRASH COLLECTION ROOMS AND CHUTES.** Automatic fire sprinkler system protection shall be provided in all laundry and trash chutes and terminal rooms. Automatic fire sprinklers shall be installed at the top of the chute and at alternate floor levels.

(3) **STORAGE AREAS.** (a) Except as provided in par. (b), automatic fire sprinkler system protection shall be provided in storage areas exceeding 100 square feet in area and located in ch. ILHR 55, 56, and 57 occupancies. The areas of individual adjacent storage areas shall be considered

cumulatively unless each storage area is separated from the adjacent area by at least 30 minute fire resistive rated construction with openings protected by 20 minute rated fire doors.

(b) Automatic fire sprinkler system protection need not be provided in the following storage area applications:

1. Storage areas not exceeding 1500 square feet in area which are separated from the remainder of the building by at least one-hour fire resistive construction and the area is equipped with an approved smoke detection system, which is:

a. Directly and permanently wired to a proper unswitched circuit; and

b. Interconnected with the building manual fire alarm system. If the building does not have a manual fire alarm system, the smoke detection system shall be capable of sounding an audible alarm which can be heard in all occupied areas of the building; and

2. Storage areas located within individual living units of ch. ILHR 57 occupancies.

(4) **STAGE AREAS REQUIRING PROSCENIUM SEPARATIONS.** Automatic fire sprinkler system protection shall be provided for all stage areas requiring proscenium separations within or behind the proscenium separation as follows:

(a) Over the stage;

(b) Under the stage gridiron with side wall sprinkler heads rated at 135° F. having heat baffle plates. The heads shall be installed around the entire perimeter of the stage, except above the proscenium opening, at points not more than 30 inches below the gridiron, nor more than 6 inches below the baffle plate;

(c) Under all fly galleries;

(d) Under the stage;

(e) In all basements, workrooms, dressing rooms, store rooms and property rooms; and

(f) In toilet, lounge and smoking rooms.

History: Emerg. cr. eff. 9-6-86; cr. Register, November, 1986, No. 371, eff. 12-1-86.

ILHR 52.013 Specified applications by occupancy or use. Except as provided in s. ILHR 52.011 (5), a complete automatic fire sprinkler system shall be installed as specified in the following occupancies:

(1) **MERCANTILE OCCUPANCIES.** (a) Except as provided in par. (b), in mercantile occupancies where the area exceeds 15,000 sq. ft. per floor or 30,000 sq. ft. total area of all floors; or the height exceeds 3 stories;

(b) Mercantile occupancies without complete automatic fire sprinkler protection may be constructed up to the areas permitted in Table 54.01-1, but not exceeding 20,000 sq. ft. per floor provided the following conditions are satisfied:

1. The building is completely equipped with an automatic smoke detection system monitored by a fire alarm system company, proprietary or remote station service;

Register, November, 1986, No. 371

2. The distance to an exit does not exceed 100 feet; and
3. Street access for fire fighting vehicles is provided on at least 50% of the building perimeter.

(2) **EXHIBITION ROOMS.** In rooms having more than 12,000 sq. ft. of floor area which can be used for exhibition or display purposes.

(3) **LIBRARIES AND MUSEUMS.** In libraries and museums either of which exceed 15,000 sq. ft. area per floor.

(4) **RESTAURANTS, NIGHT CLUBS AND DANCE HALLS.** (a) In restaurants where the floor area exceeds 12,000 sq. ft. or where the capacity is more than 1,000 persons.

(b) 1. In buildings with rooms primarily used for dance halls or entertaining occupants who are drinking or dining and unseparated accessory uses where the total area exceeds 5,000 sq. ft. or where the capacity is more than 300 persons.

2. The area of accessory rooms such as but not limited to kitchens, storage rooms and other use areas shall be included unless the accessory rooms are separated from the remainder of the building by at least one-hour fire-resistive construction.

(5) **DETENTION AND CORRECTION FACILITIES.** In all detention and correctional facilities with a resident population of 6 or more.

(6) **STORAGE OCCUPANCIES.** (a) 1. Except as provided in par. (b), in buildings having an area exceeding 20,000 sq. ft. and used for high-piled storage of moderate hazard contents as specified in subd. 2.

2. High-piled storage shall include moderate hazard combustible materials in closely packed piles more than 15 feet in height or moderate hazard combustible materials on pallets or in rack more than 12 feet in height.

(b) 1. The automatic fire sprinkler system protection may be limited to the storage area of the building only provided the storage area is separated from the remainder of the building by at least 2-hour fire-resistive construction.

2. Automatic fire sprinkler system protection need not be provided in freezer warehouses.

Note: See s. ILHR 54.01 (2) (c) for additional requirements.

(c) The automatic fire sprinkler protection required by this subsection shall be in accordance with NFPA Standards No. 231 — Standard for General Storage and No. 231C — Standard for Rack Storage of Materials.

Note: See s. A52.011 for additional information on classification of hazards.

(7) **HIGH HAZARD BUILDINGS.** (a) Except as provided in par. (b), an automatic fire sprinkler system shall be installed in all high hazard occupancies exceeding 3000 sq. ft. in floor area.

Note: See s. A52.011 of Appendix A for additional information regarding classification of hazards.

(b) When approved by the department, alternate types of fire protection or suppression systems as may be appropriate for the particular hazard may be provided.

Note: The department will request a position statement regarding the proposed method to be submitted by the Fire Chief of the municipality having jurisdiction.

History: Emerg. cr. eff. 9-6-86; cr. Register, November, 1986, No. 371, eff. 12-1-86.

ILHR 52.015 Automatic fire sprinkler systems for low rise buildings. **History:** Cr. Register, June, 1983, No. 330, eff. 7-1-83; emerg. r. and recr. (4) and r. (5), eff. 10-10-83; am. (3) (a) 1. and 5., (h), r. (3) (b) 2. b., renun. (3) (b) 2. c. to be (3) (b) 2. b., r. and recr. (3) (c), (d), (j), (4) and (5), cr. (6), Register, February, 1984, No. 338, eff. 3-1-84; emerg. r., eff. 9-6-86; r. Register, November, 1986, No. 371, eff. 12-1-86.

ILHR 52.02 Windows. (1) **NATURAL LIGHT.** (a) Except as provided in par. (b), every room in which one or more persons live, sleep, shall be lighted by a window or windows opening directly upon a street or alley, or upon a court on the same lot with the building.

1. The windows shall be so constructed and distributed as to afford light.

2. Every building more than 40 feet deep measuring at right angles to the windows, shall have windows on at least 2 sides of the building.

Note: For windows and other outdoor openings used for natural ventilation, see ss. ILHR 64.07, 57.13, 58.03, 58.45 and 60.13.

(b) 1. Windows shall not be required in storage rooms, factories, offices, mercantile facilities, educational facilities or areas where the nature of occupancy will not permit windows provided artificial lighting as specified in ch. Ind 19 is provided.

FP 2. Hotel and motel rooms and similar sleeping rooms in buildings accommodating transients need not be provided with openable windows provided the rooms have clear glazed panels facing naturally lighted pool or recreation areas. The rooms shall be provided with mechanical ventilation supplying at least 5 CFM of tempered outside air per occupant.

(2) **FIRE DEPARTMENT ACCESS OPENINGS.** (a) *Application.* Except as provided in s. ILHR 52.012 (1) (b) and (c), every basement or floor level either of which is not protected by an automatic fire sprinkler system shall be provided with at least 20 square feet of aggregate opening in each 50 lineal feet of exterior wall in the story or basement, on at least one side of the building.

Note: Openings 20 sq. ft. in area spaced 100 feet apart and no more than 50 feet from the end of a wall satisfy the intent of this subsection.

(b) *Dimensions.* Openings shall have minimum dimensions of not less than 22 inches by 42 inches. The bottom of the opening shall be not more than 48 inches above the floor.

(c) *Accessibility.* The openings shall be accessible to the fire department from the exterior and shall be unobstructed to allow fire-fighting and rescue operations.

1. a. A clear space not less than 5 feet in width measured perpendicular to the building wall shall be provided outside of access openings.

Register, November, 1986, No. 371

b. A stairway or ramp to grade not less than 3 feet in width shall be provided where the bottom of the opening is more than 4 feet below grade.

2. An interior stairway may serve as basement access if the stairway leads directly to an exterior door and is separated at the first story with one-hour fire-resistive rated construction and protected openings. The stairway may not serve any floor level above the first story.

3. A skylight or hatch may serve as a basement access opening if a ladder or stairs from the floor below is provided.

4. Access openings shall be doors, windows, glazed panels or other panels readily identifiable and openable from the outside. Access panels requiring the use of a key, special tools or devices for opening will be permitted if approved by the fire department having jurisdiction.

5. The fire department access shall open into the general area of the floor being served, where an aisle or passageway leading to the opening can be maintained clear of obstructions.

Note: An opening located within a tenant storage cubicle is not acceptable.

(d) *Number of openings required.* Every story of a building more than 75 feet deep, measuring at right angles to the openings, shall have openings in that story on at least 2 sides of the building.

(e) *Locations.* Openings in the basement shall be located so any location in the basement is within 75 feet of an opening.

History: 1-2-56; am. Register, December, 1962, No. 84, eff. 1-1-63; r. and recr. (1) (a), Register, October, 1967, No. 142, eff. 11-1-67; am. (1) (a) Register, May, 1971, No. 186, eff. 6-1-71; r. and recr., Register, September, 1973, No. 213, eff. 10-1-73; cr. (1) (b), Register, January, 1980, No. 289, eff. 2-1-80; r. and recr. Register, June, 1983, No. 330, eff. 7-1-83; r. and recr. (2), Register, February, 1984, No. 338, eff. 3-1-84; emerg. r. and recr. (2), eff. 9-6-86; r. and recr. (2), Register, November, 1986, No. 371, eff. 12-1-86.

ILHR 52.03 Window cleaning. (1) Where the tops of windows to be cleaned are more than 20 feet above the floor, ground, flat roof, balcony, or permanent platform, one of the following means shall be provided to protect the window cleaners.

(a) Approved attachments for window cleaner safety belts to which belts may be fastened at each end. The attachments shall be permanent devices that shall be firmly attached to the window frame, or to the building proper, and so designed that a standard safety belt may be attached thereto; or

(b) An approved portable platform that is projected through the window or supported from the ground, floor, roof or platform level, for the window cleaner to stand upon and that is designed, constructed, maintained and equipped with handrail and toeboard in compliance with the requirements of ch. Ind 1.

(c) A suspended scaffold, swinging scaffold, swinging chair scaffold, or boatswain's chair scaffold designed, constructed, equipped and maintained in compliance with the requirements of ch. Ind 35, or

(d) Other equally effective devices.

(e) Where the window consists of a fixed panel not more than 24 inches in width alongside a removable panel, the fixed panel may be cleaned by reaching through the opening of the removable panel. Where the window consists of a fixed panel between 2 removable panels, the fixed panel may be cleaned by reaching through the openings if such fixed panel is not more than 36 inches in width.

(2) For cleaning the insides of skylights (the highest parts of which are more than 20 feet above the floor, ground, balcony or permanent platform), to which access cannot be gained by any of the means described in s. Ind 1.16 (1), scaffolds as specified in ch. Ind 35 shall be provided.

(3) All equipment, including building parts and attachments, used in connection with window cleaning, shall be maintained in reasonably safe condition while in use and shall be inspected at least once each month while in use, and within 30 days before their use. It shall be the responsibility of the owner of the individual safety devices or equipment to inspect and maintain the devices or equipment belonging to the owner so that each will comply with the requirements of this section.

(4) Where the attachments specified in sub. (1) (a) are relied upon for compliance with the provisions sub. (1), the employer shall furnish or see that there is provided, an approved suitable safety belt for each employe while cleaning windows.

History: 1-2-56; am. Register, December, 1962, No. 84, eff. 1-1-63; am. (1) (a), (3) and (4), Register, December, 1981, No. 312, eff. 1-1-82.

ILHR 52.04 Requirements for barrier-free environments. (1) SCOPE. The requirements of this section are intended to insure that all public buildings and places of employment shall be accessible and usable by all citizens, including those with functional limitations.

Note: Owners intending to utilize federal funds for buildings may have to comply with other requirements in addition to ILHR 52.04, such as the latest revised ANSI A 117.1, Specification for Making Buildings and Facilities Accessible To, and Usable By, the Physically Handicapped.

(2) **DEFINITIONS.** (a) *Access or accessible.* Access or accessible means the ability of a person with a functional limitation caused by impairments of sight, hearing, incoordination, perception, semiambulatory or nonambulatory disabilities to enter and leave a public building, circulate through a public building, and use the public toilet facilities without assistance. Functional limitations may require aids such as wheelchairs, crutches, braces or canes.

(b) *Primary floor.* A primary floor is one intended for use by the employes or patrons, or both. A floor used primarily for furnace room or storage areas, or both, is not considered a primary floor.

Note: If more than one floor meets the definition of a primary floor, and access is required only to one primary floor, the owner may designate which primary floor will be provided with accessibility.

(c) *Public entrance.* Any major access point to a building used for the purpose of entering the building and gaining access to a primary floor is

considered a public access. Entrances used only for service or maintenance purposes, or designated for emergency exit only, are not considered public entrances.

(3) **SITE REQUIREMENTS.** A means of access shall be provided from an ancillary parking facility, street or alley to the public entrance.

(a) *Parking spaces.* Where parking spaces are provided, accessible parking spaces, at least 12 feet wide, shall be provided and designated as specified in Table 52.04-A. Access ramps or curb ramps shall not be located in the accessible parking space or any other parking space.

Note: See Appendix for examples of curb ramp locations.

TABLE 52.04-A
Accessible Parking Spaces

TOTAL PARKING SPACES	REQUIRED NUMBER OF ACCESSIBLE SPACES
1 - 1,000	2% of total number of spaces with a minimum of one
Over 1,000	20 plus 1% for total number of spaces over 1,000

1. **Identification.** Exterior signs as specified in s. Trans 200.07, Wis. Adm. Code, shall identify all accessible parking spaces and shall direct persons from the accessible parking space to the accessible entrance.

Note: See Appendix A for a reprint of s. Trans 200.07, Wis. Adm. Code.

2. **Location.** All accessible parking spaces shall be located as close as possible to an accessible entrance via an accessible route. Parking spaces in a parking ramp shall be located as close as possible to the main entrance of the parking ramp, to an adjacent accessible public walk, or to an accessible elevator.

(b) *Curb ramps.* 1. Where accessible walks cross driveways, parking facilities, streets or alleys, curb ramps shall be used to provide a means of access.

2. The design and construction of curb ramps shall comply with the provisions of s. 66.616 (3) (a), Stats.

Note: See Appendix A for a reprint of s. 66.616 (3) (a), Stats.

3. Handrails shall not be required for curb ramps which overcome a difference in elevation of 8 inches or less.

4. Curb ramps shall be located to provide the shortest line of travel from the accessible parking space to the accessible public entrance.

(c) *Exterior walks.* Exterior walks are prepared surface, exterior pathways leading to or from a building and are on the same level as the adjacent ground. Exterior walks leading to accessible entrances shall comply with the following criteria:

1. Exterior walks shall have a slip-resistant surface and shall have a minimum width of 48 inches, of which not more than 4 inches on each side may be occupied by a handrail.

2. Gradients. Exterior walks shall have a gradient no more than 5% or 1:20;

3. Handrails. Handrails are not required at exterior walks, except on those sides where the adjacent terrain exceeds a 25% (1:4) downward slope away from the walk. Required handrails shall be at least 2 feet 8 inches high, with an intermediate parallel rail at mid-height; and

4. Rest Platforms. Rest platforms are not required at walks.

(d) *Exterior ramps.* Exterior ramps are sloping walks or sloping structures having a gradient greater than 5% (1:20) and which provide access to or from a building. Exterior ramps shall comply with the following criteria:

1. Width. Exterior ramps shall have a slip-resistant surface and shall have a minimum width of 48 inches, of which not more than 4 inches on each side may be occupied by a handrail;

2. Gradients. Exterior ramps shall not have gradients greater than 8.33% or 1:12 slope;

3. Handrails. Graspable handrails shall be provided as follows:

a. Location. 1) Ramps with a gradient greater than 5% (1:20), but less than 8.33% (1:12) shall have a handrail on one side of the ramp;

2) Ramps with a gradient of 8.33% (1:12) shall have handrails on each side of the ramp; and

3) Handrails shall be provided on those sides where the adjacent terrain exceeds a 25% (1:4) downward slope away from the ramp.

b. Height. Handrails shall be mounted so that the top of the handrail is located between 30 inches to 34 inches above the ramp surface.

c. Midrails. Open-sided ramps shall have an intermediate parallel rail located at mid-height between the handrail and the ramp surface.

d. The clear space between the handrail and any adjoining wall shall be between 1½ inches to 2 inches.

4. Clearance. a. Where exterior ramps are provided to accessible doorways, the floor on each side of the doorway shall be level for a distance of 5 feet from the door.

b. Exterior ramps shall have a level platform at least 5 feet long where they turn and at least 5 feet of level clearance at the bottom of the ramp.

5. Rest platforms. All exterior ramps longer than 30 feet in length shall have 5-foot long level platforms at a maximum of 30-foot intervals.

(e) *Communication between buildings.* Walks or enclosed passageways which connect 2 or more buildings and are intended for public use shall provide access to each building.

(4) **NEW CONSTRUCTION.** All new public buildings and places of employment shall be provided with access to a primary floor, interior circulation and toilet facilities in accordance with Table 52.04 and the requirements of sub. (4). All buildings with multiple uses shall comply with sub. (5).

Note: Access to all areas of the building is preferred, however the footnotes in Table 52.04 designate specific exemptions and requirements for access to the primary floor, interior circulation, and toilet facilities for the occupancies listed.

(a) *Access to the primary floor.* Access from the exterior grade to a primary floor, via a public entrance, shall be provided by means of ramps, grade-level entrances, or other means of access approved by the department.

(b)* *Interior circulation.* Access shall be provided to all areas of the building as specified in Table 52.04. Interior circulation between floor levels shall be accomplished as follows:

1. In any public building or place of employment, the following methods of interior circulation may be used:

- a. Ramps complying with s. ILHR 52.04 (7);
- b. Elevators complying with ch. ILHR 18;
- c. Vertical lifts complying with ch. ILHR 18; and
- d. Enclosed inclined wheelchair lifts complying with ch. ILHR 18.

2. The following lifts may be installed in new or existing places of worship and lodge halls of fraternal organizations as defined in ch. 614, Stats., if interior circulation between floor levels is not required by this section:

- a. Unenclosed inclined wheelchair lifts complying with ch. ILHR 18;
- b. Stairway chairlifts complying with ch. ILHR 18; and
- c. Residential-type elevators complying with ch. ILHR 18.

(c) *Toilet facilities.* Accessible toilet facilities shall be provided on a primary floor or accessible from a primary floor. Every floor which is accessible, and which is provided with required toilet facilities, shall be provided with accessible toilet facilities which comply with the requirements of sub. (8) and the following distribution:

1. Accessible water closets shall be provided at the rate of 10% of the total number of toilet facilities provided on each accessible floor, with a minimum of one for each sex; and

2. One accessible toilet room is required in buildings accommodating 10 or less employees and less than 25 patrons per s. ILHR 54.12 (1) (a) 1.

*See Appendix A for further explanatory material.

TABLE 52.04
 REQUIREMENTS FOR NEW CONSTRUCTION

Occupancy and Type of Construction	Access to Primary Floor	Interior Circulation	Toilet Facilities
I. All public buildings and places of employment not listed in categories II-XII	Yes	Yes ¹	Yes
II. Government-owned buildings except those occupancies listed under V and IX D	Yes	Yes	Yes
III. Factories, office and mercantile buildings, and shopping malls	Yes	Yes ^{1, 2, 3}	Yes ^{4, 5}
IV. Theaters and assembly halls			
A. Churches (chs. ILHR 54 and 55) ..	Yes	Yes ^{1, 6}	Yes ⁷
B. Auditoriums, theaters, stadiums and permanent bleachers	Yes	Yes ^{1, 6}	Yes
C. Night clubs, bars, restaurants (chs. ILHR 54 and 55)	Yes	Yes ¹	Yes
D. Recreational facilities (chs. ILHR 54 & 55)	Yes	Yes ^{1, 8}	Yes
V. Schools and other places of instruction	Yes	Yes ^{1, 9}	Yes
VI. Libraries, museums and art galleries..	Yes	Yes ¹	Yes
VII. Places of abode			
A. Residential living units with individual exterior entrances	Yes ¹⁰	Yes ¹¹	Yes ¹²
B. All other residential living units (apartment-type buildings)	Yes ¹³	Yes ¹⁴	Yes ¹²
C. Hotels and motels	Yes	Yes ¹⁵	Yes ¹⁶
D. Condominiums	Yes ¹⁷	Yes ¹⁸	Yes ¹²
VIII. Day care centers	Yes ¹⁹	Yes ^{1, 19}	Yes ¹⁹
IX. Health care facilities			
A. Hospitals	Yes ²⁰	Yes ²⁰	Yes ²⁰
B. Nursing homes	Yes ²⁰	Yes ²⁰	Yes ²⁰
C. Community-based residential facilities	Yes ²¹	Yes ²¹	Yes ²¹
D. Dental and medical clinics and offices	Yes	Yes ^{1, 22}	Yes
X. Places of detention	Yes	Yes ^{1, 23}	Yes
XI. Garage occupancies	Yes	Yes ¹	Yes
XII. Specialty occupancies			
A. Open parking structures	Yes ²⁴	Yes ²⁴	Yes ²⁴
XIII. Mechanical equipment rooms, maintenance equipment and other storage rooms, janitor closets, storage warehouses, saw and feed mills, motion picture booths, portable bleachers, steel mills, steel fabricating plants, slaughter houses, storage and truck docks and shipbuilding facilities and similar occupancies determined by the department	No	No	No

Note: Floors used entirely for storage or mechanical purposes need not be included in determining the total gross area.

Footnotes of Table 52.04:

¹ (a) All buildings. Access is not required to a mezzanine if duplicate facilities to those provided on the mezzanine are located on an accessible floor. Access is required to employe facili-

ties, including but not limited to lunch rooms, change rooms and locker rooms, required by s. ILHR 54.13.

(b) *Buildings having an area 20,000 square feet or less.* If the total gross area of the building including all floors, is 20,000 square feet or less, interior circulation is required to a primary floor and throughout at least 2/3 of that floor area. Access is required to any raised or depressed area of the primary floor containing the only facility of its kind.

(c) *Buildings having an area greater than 20,000 square feet.* If the total gross area of the building, including all floors, is greater than 20,000 square feet, interior circulation is required to all floors and to at least 2/3 of the total area of each floor. Access is required to any floor level containing the only facility of its kind.

2 (a) Each tenant space shall be considered a separate building for determining requirements for interior circulation within each tenant space.

(b) When more than 50% of the tenant spaces are remodelled in an existing shopping mall, all public use areas shall be made accessible in accordance with s. ILHR 52.04 (3), (4) and (9).

3 In retail establishments providing fitting rooms, at least one fitting room shall be accessible.

4 If the required toilet facilities are not accessible in buildings accommodating 15 or less employees and 25 or less patrons, one additional accessible toilet room for both sexes shall be provided. That toilet facility shall be located on an accessible floor and shall contain one lavatory and one water closet. A privacy lock for the door shall be provided.

5 In enclosed shopping malls, toilet facilities provided within a tenant space less than 750 square feet in net area, are not required to be accessible, providing accessible public toilet facilities are provided in the mall. Toilet facilities provided in accordance with s. ILHR 54.2 (1) (b) shall be accessible.

6 Seating spaces, at the rate of 2% of the total capacity with a maximum of 50 seats shall be integrated throughout the seating plan.

One-half of the accessible seating spaces shall be designed for patrons using wheelchairs. The wheelchair space shall be level. Removable seats may be installed in these wheelchair spaces when these spaces are not required to accommodate wheelchair users. The other spaces shall be designed for patrons using braces, crutches, or similar aids.

Ramp details [s. ILHR 52.04 (7)] do not apply to the aisles in theater auditoriums.

7 In remodeled churches, a separate accessible toilet room for use by both sexes is acceptable if the toilet room is located on an accessible floor, contains one lavatory and one water closet, and is provided with a privacy lock.

8 In buildings containing recreational facilities, access shall be provided to 10% of the individual game areas including bowling alleys, tennis courts and similar areas, with a minimum of one individual game area. Access shall be provided to toilets, lounge areas, bar, dining areas and similar areas as specified in footnote #1. Access is not required to saunas, racquet ball courts, handball courts and locker rooms associated with these areas.

9 If the total gross area of the building including all floors is 20,000 square feet or less, access is required to a primary floor and to any other floors or floor levels that provide services or facilities that are not found on the accessible floor.

10 Access to a primary floor shall be provided to at least 10% of the living units, with a minimum of one living unit. In a complex of buildings, the accessible units shall be integrated throughout at least 50% of the buildings in the complex.

11 Doors and corridors shall be designed for access and shall comply with s. ILHR 52.04 (9). Doors to walk-in closets shall be a minimum of 32 inches in width.

12 Grab bars, special lavatories, water closets, mirrors, or special bathing facilities are not required.

13 Access shall be provided to a primary floor with living units. In a complex of buildings, access shall be provided to at least 50% of the buildings in the complex.

14 All doors and corridors within all living units located on the accessible floor shall be designed for access and shall comply with s. ILHR 52.04 (9). Doors to walk-in closets shall be a minimum of 32 inches in width. If laundry, storage, trash facilities, or similar areas, are provided in buildings with more than 20 living units per building, the laundry or storage facilities, or both, shall be accessible.

15 (a) *Number of accessible sleeping units.* 1. In a hotel or motel, or a hotel or motel complex providing meeting or conference room facilities, accessible sleeping units shall be provided at a rate of 10% of the total number of sleeping units, with a minimum of one.

2. In a hotel or motel, or a hotel or motel complex not providing meeting or conference room facilities, accessible sleeping units shall be provided at a rate of 5% of the total number of sleeping units, with a minimum of one.

(b) *Interior circulation.* All doors and corridors throughout the accessible sleeping units shall be designed for access and shall comply with s. ILHR 52.04(9). Doors to walk-in closets shall be a minimum of 32 inches in width.

(c) *Access requirements.* Access is required to all public use areas of the building or complex. In a complex of buildings with sleeping units, access shall be provided to at least 50% of the buildings in the complex.

16 Accessible bathtubs or showers shall be provided and shall comply with s. ILHR 52.04 (8) (h). Self-rising toilet seats and sliding-door tub enclosures are prohibited.

17 Condominiums, 2 stories or less in height, are exempt from the accessibility requirements relating to parking spaces, ramps and grade-level entrances.

18 All doors and corridors shall be designed for access and shall comply with s. ILHR 52.04 (9). Doors to walk-in closets shall be a minimum of 32 inches in width.

19 Access, interior circulation, and toilet facilities do not apply to a change of use.

20 See ss. ILHR 52.041 and 52.042 for additional requirements on accessibility.

21 For community-based residential facilities within the scope of ch. ILHR 61, see s. ILHR 61.18 for additional requirements; for community-based residential facilities within the scope of ch. ILHR 57, common-use areas and 10% of the sleeping rooms shall be accessible.

22 If the total gross area of the building including all floors is 20,000 square feet or less access is required to a primary floor and to any other floors or floor levels that provide services or facilities for the employees and the patients that are not found on the accessible floor.

23 (a) In penal institutions, 2% of the total number of required institutional living units shall be accessible. Vertical transportation between tiers of cells is not required.

(b) Access is required to all areas identified for use by the general public.

24 See s. ILHR 62.34 for additional requirements.

(5) **BUILDINGS WITH MULTIPLE USES.** (a) *Buildings greater than 20,000 square feet.* Multiple-use buildings with a total gross area greater than 20,000 square feet, including all floors, shall comply with the criteria established in Table 52.04 for each specific use. Interior circulation is required to and throughout at least $\frac{2}{3}$ of each specific use area.

(b) *Buildings of 20,000 square feet or less.* Multiple-use buildings with a total gross area of 20,000 square feet or less, including all floors, shall be provided with a means of access to and throughout at least $\frac{2}{3}$ of the total area of the primary floor and to the toilet facilities on the primary floor. Government-owned buildings and dental and medical clinics and offices shall comply with the criteria established in Table 52.04 for each specific use.

Note: Floors used entirely for storage or mechanical purposes need not be included in determining the total gross area.

(6) **ADDITIONS, REMODELED BUILDINGS, AND CHANGE OF USE.** All existing public buildings or places of employment, and all additions, shall be provided with access to a primary floor, interior circulation and toilet facilities in accordance with the following:

(a) *More than 50% remodeled or added.* If more than 50% of the gross interior area of a building is remodeled, added to or both, the entire building shall comply with all applicable requirements of s. ILHR 52.04.

(b) *25% to 50% remodeled or added.* If 25% to 50% of the gross interior area of a building is remodeled, added to or both, that part of the building which is remodeled, added to or both shall be provided with the requirements of Table 52.04 and sub. (4).

(c) *Less than 25% remodeled or added.* If less than 25% of the gross interior area of a building is remodeled, added to or both, the requirements of Table 52.04 and sub. (4) need not be provided unless the remodeling or addition involves an entrance or exit or toilet facilities in which case the entrance or exit or toilet facility shall comply with sub. (4). Additions, larger than 20,000 square feet gross area, shall comply with Table 52.04 and subs. (3), (4) and (9) regardless of the percent of floor area of the entire building.

(d) *Toilet facilities in remodeled buildings.* If an existing building having passenger elevators is remodeled in accordance with the percentages above, accessible toilet room facilities for each sex shall be provided to serve each 5 floors, or fraction thereof, and shall comply with the requirements of sub. (8);

(e) *Change of use.* If the use of an existing building is changed to a new use and the building undergoes physical remodeling, the building shall comply with the percentages established in sub. (6);

(f) *Remodeling in stages.* The percentage requirements established in this subsection shall apply to the accumulative sum of any remodeling or additions, or both, undertaken after May 15, 1974.

(7) **INTERIOR RAMPS.** Interior ramps are sloped floor surfaces that connect different floor levels. Interior ramps shall comply with the following criteria:

(a) *Width.* Interior ramps shall have a slip-resistant surface and shall have a minimum width of 36 inches, measured between handrails.

(b) *Slope.* 1. "New construction". In new buildings, interior ramps shall not have a slope greater than one foot of rise in 12 feet of run.

2. "Existing construction". In existing buildings, interior ramps with a slope of one foot of rise in 8 feet of run may be used to overcome a total height not greater than 2 feet when the floor area does not permit a 1:12 ramp.

(c) *Handrails.* Except as provided in subd. 5., graspable handrails shall be provided as follows:

1. *Location.* a. Interior ramps with a gradient greater than 5% (1:20), but less than 8.33% (1:12) shall have a handrail on one side of the interior ramp;

b. Interior ramps with a gradient of 8.33% (1:12) or greater shall have handrails on each side of the ramp; and

c. Handrails are not required on interior ramps where the gradient is less than 5% (1:20).

2. *Height.* Handrails shall be mounted so that the top of the handrail is located between 30 inches to 34 inches above the ramp surface.

3. Guardrails. Open-sided ramps shall have an intermediate parallel guardrail located at mid-height between the handrail and the ramp surface.

4. The clear space between the handrail and any adjoining wall shall be between 1½ inches to 2 inches.

5. One handrail may be provided for ramps located in existing corridors or hallways having a minimum width of 36 inches.

(d) *Clearance.* 1. Where interior ramps are provided to accessible doorways, the floor on each side of the doorway shall be level for a distance of 5 feet from the door.

2. Interior ramps shall have a level platform at least 5 feet long where the ramps turn and at least 5 feet of level clearance at the bottom of the ramp.

(e) *Rest platforms.* 1. Interior ramps with a gradient greater than 5% (1:20) shall have a 5-foot long level platform at a maximum of 30-foot intervals.

2. Rest platforms are not required on interior ramps where the slope is less than one foot of rise in 20 feet of run.

(8)* **TOILET FACILITY DETAILS.** (a) *Accessible toilet rooms and compartments.* Accessible toilet rooms and toilet compartments shall be sized to provide ease of access, usability and uninterrupted mobility. Fixtures, doors, and other obstructions shall be arranged to ensure accessibility.

(b) *Single-fixture toilet rooms.* Single-fixture toilet rooms containing one water closet and one lavatory shall be designed to provide the minimum space requirements as shown in diagram A, diagram B, or as approved by the department.

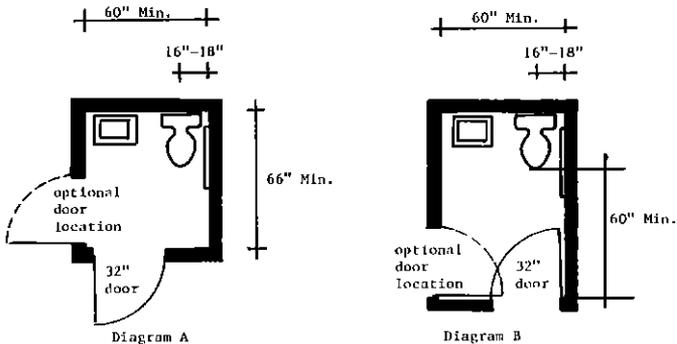

(c) *Water closet compartments.* Accessible water closet compartments shall be designed in accordance with the minimum design standards as established in Table 52.04-B, or as approved by the department. Sufi-

*See Appendix A for further explanatory material.

cient clearance must be maintained to permit the door to the toilet room compartment to open at least 95°.

Note: The water closet compartment specifications contained in Table 52.04-B do not apply to toilet rooms containing one water closet and one lavatory; or to bathrooms containing a water closet, a lavatory and a bathing facility. See the appendix for examples of accessible toilet room and bathroom arrangements.

TABLE 52.04-B

Compartment Size ¹ Width/Length	Door Location	Minimum ¹ Door Size	Water Closet Location	Grab Bar Location
36" x 78"	Front entrance	32"	Centered	Each side of WC
36" x 78"	Side entrance	36"	Centered	Each side of WC
54" x 57"	Front entrance (Door shall not align with water closet)	32"	Offset ^{2 3}	Wall closest to WC and wall behind WC
42" x 78"	Side entrance	36"	Centered	Each side of WC
48" x 72"	Side entrance	32"	Offset ^{2 3}	Wall closest to WC and wall behind WC

¹ See Figure 52.04-1 for additional rules regarding door and corridor dimensions.

² The 54" x 57" compartment is preferred for use by the physically disabled.

³ Water closet shall be offset 16 to 18 inches measuring from center line of water closet to wall.

(d) *Grab bars.* 1. Grab bar loads. Each grab bar shall be designed and anchored to support a weight of at least 250 pounds, applied at the bar.

2. Diameter. The grab bars shall have a smooth finish, with an approximately outside diameter between one inch to 1½ inches, and with 1½ inches clearance between rail and wall.

3. Height. Grab bars shall be installed 33 inches to 36 inches above the floor and parallel to the floor.

Note: Grab bars located 16 inches above the water closet seat are preferred for use by people with physical disabilities.

4. Location. a. Grab bars shall be located as specified in Table 52.04-B.

b. In single fixture toilet rooms containing one water closet and one lavatory, one grab bar shall be located on the wall adjacent to the water closet and one behind the water closet.

(e) *Water closets.* The seat height of the water closets shall be 17 inches to 19 inches above the floor measured from the floor to the top of the seat.

(f) *Urinals.* Wall-hung urinals shall have an elongated rim and shall be mounted not more than 17 inches above the floor.

(g) *Lavatory.* At least one lavatory, mounted at a height which allows 29 inches clear space at the bottom of the apron and a maximum rim height of 34 inches, shall be provided.

Note: It is recommended that water supply controls be single lever controls and that exposed hot water pipes be insulated.

(h) *Mirror and towel dispensers.* At least one mirror and towel dispenser or hand dryer, when provided, shall be mounted not more than 40 inches above the floor.

Note: The department will accept toilet rooms, individual toilet compartments and grab bars as illustrated in the Appendix.

(i) * *Accessible bathing facilities.* 1. The bathtub shall be equipped with a hand shower with a flexible hose at least 6 feet in length. A seat of nonabsorbent material shall be provided and shall be mounted 17 to 20 inches above the floor of the bathtub. The seat may be folding, retractable or fixed, unless an alternate method, such as a lift, is provided. Grab bars shall be mounted on 2 sides of the bathtub and shall comply with the requirements of par. (d) 3. In detention or correctional facilities, 2 fixed shower heads may be provided in lieu of a hand shower with a flexible hose.

Note: Refer to ch. ILHR 82 — Design, Construction, Installation, Supervision and Inspection of Plumbing, for requirements pertaining to the plumbing system, including the use of vacuum breakers.

2. The shower shall be equipped with lever type control handles. A seat of nonabsorbent material shall be provided and located 17 to 20 inches from the floor of the shower. The seat may be folding, retractable or fixed. Grab bars shall be mounted on 2 sides of the shower and shall comply with the requirements of par. (d) 4. If a shower wheelchair is provided for use in the shower, the grab bars and seat are not required. The threshold to the shower shall be no more than ½-inch and the edges shall be beveled to provide a smooth, unbroken surface to accommodate a wheelchair.

(9) DOORS, CORRIDORS AND PLATFORMS. (a) *Doors and corridors.* All doors and corridors shall be designed to provide access and shall comply with the minimum design standards established in Figure 52.04-1, or as approved by the department.

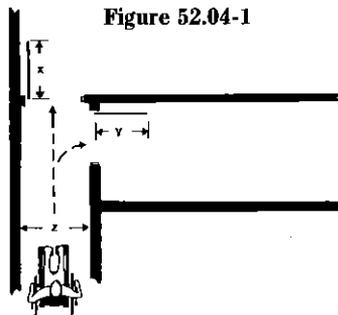

MINIMUM DOOR AND CORRIDOR DIMENSIONS		
CORRIDOR WIDTH	DOOR WIDTHS	
Z*	X(Straight Run)	Y(90° Turn)
36"	32"	36"
38"	32"	36"
40"	32"	34"
42" and greater	32"	32"

* The corridor width (Z) shall be maintained for a distance of at least 5 feet from the edge of the door opening.

Note: These dimensions apply if a right or left turn is provided, or if the doors are hinged on the left or right side.

(b) *Door sizes.* The minimum door size to provide access shall be 32 inches in width. Doors shall provide minimum clear openings as specified in subs. 1.-3.

1. Doors 32 inches in width shall provide a minimum clear opening of 29 inches.

2. Doors 34 inches in width shall provide a minimum clear opening of 31 inches.

3. Doors 36 inches in width shall provide a minimum clear opening of 33 inches.

(c) *Door thresholds.* Thresholds at exterior doors shall not extend more than $\frac{3}{8}$ inch above the finished floor and exterior platform. Weather-stripped thresholds shall not exceed one inch above the finished floor and exterior platform, including the weather-stripping. All exterior thresholds shall be not less than 4 inches in width. Interior thresholds shall extend not more than $\frac{1}{2}$ inch above the finished floor or carpeting. All thresholds shall be beveled to provide smooth, unbroken surfaces.

(d) *Doors in series.* All doors in series, other than those which are electronically controlled, or located in individual living units, shall be arranged to provide a minimum distance of 6 feet 6 inches between the doors when closed.

Note #1: See Appendix for diagrams.

Note #2: Lever handles or door handles are recommended over conventional door knobs. Kickplates, 16 inches high, are recommended on the accessible side of doors. Automatic power-operated doors are recommended at entrances. Time-delay door closers are recommended at all accessible doors. The manual pull or push of a door is recommended not to exceed 8 pounds.

(e) *Platforms at exterior doors.* At least 18 inches of clear platform space shall be provided on the door knob side of all exterior doors. The platform shall have a side slope not greater than 2.5% ($\frac{1}{4}$ inch per foot) and shall be at least 4 feet in length when the door swings inward or 5 feet in length when the door swings outward.

(10) MISCELLANEOUS DETAILS. (a)* *Identification signs.* 1. International symbol for barrier-free environments. The international symbol for barrier-free environments shall identify all accessible entrances, toilet facilities, drinking fountains, telephones and parking spaces.

2. Location. The international symbol for barrier-free environments shall be placed at all entrances indicating the location of the nearest accessible entrances and accessible toilet facilities. The symbol at the exterior of the building shall be legible from adjacent streets, driveways or public walks.

Note: Also see s. Trans 200.07 for additional requirements.

(b)* *Wheelchair functions.* All 90°, 180°, 360° and S-turns shall be designed to provide ease of access, usability and uninterrupted mobility.

Note #1: The standard wheelchair dimensions are: length including footrest and feet, 48 inches; width, including hands and knuckles, 30 inches.

Note #2: The minimum space required to turn 90°, 180°, 360° and S-turns is illustrated in the Appendix.

*See Appendix A for further explanatory material.

(c) *Grates.* All openings in gratings that will be in the path of access shall not exceed $\frac{3}{8}$ -inch in width, and shall be installed perpendicular to the direction of travel. Spacers perpendicular to the grate and flush with the top of the grate shall be provided at not more than 18-inch intervals.

(d) *Public telephones.* If a public telephone is provided, it shall be accessible and installed with the height of the telephone coin slot not more than 54 inches above the floor, with the dial no more than 48 inches above the floor. In a multi-phone installation, a minimum of one telephone shall be accessible.

Note: An adjustable volume control should be provided in areas where such service is appropriate.

(11) **DRINKING FACILITIES.** Accessible drinking facilities shall be provided at the rate of 10% of the required drinking facilities as specified in chs. ILHR 54 to 62, with a minimum of one.

(a) *Drinking fountains and water coolers.* Drinking fountains and water coolers shall comply with the following:

1. Spout height. Spouts shall be not higher than 36 inches measured from the floor or ground surfaces to the spout outlet.

2. Spout location. The spouts of drinking fountains and water coolers shall be at the front of the unit and shall direct the water flow in a trajectory that is parallel or nearly parallel to the front of the unit. The spout shall provide a flow of water at least 4 inches high so as to allow the insertion of a cup or glass under the water flow.

3. Controls. Unit controls shall be front mounted or side mounted near the front edge.

Note: It is recommended to have lever-type controls.

4. Clearances. a. Wall and post-mounted cantilevered units shall have a clear knee space between the bottom of the apron and the floor or ground at least 27 inches high, 32 inches wide, and 17 inches to 19 inches deep.

b. Free-standing or built-in units not having a clear space under them shall have a clear floor space at least 36 inches by 48 inches that allows a person in a wheelchair to make a parallel approach to the unit.

5. Alcoves. Water fountains and water coolers shall be located completely within alcoves, or positioned so as not to encroach into pedestrian walk-ways. Alcoves shall be not less than 32 inches in width and 18 inches in depth.

Note: See Appendix for drawings of accessible water fountains and water coolers.

(b) *Drinking facilities provided with individual cups.* Drinking fountains using individual cups at a potable water source shall comply with sub. (8) for accessible lavatories and the individual cups and cup dispenser shall be accessible and located not more than 40 inches above the floor.

History: Cr. Register, December, 1974, No. 228, eff. 1-1-75; r. and recr. (3) (b), (4), (5) and (9) (a) and (b), am. (6), (7) (a), (7) (e), (8) (c) and (d), r. (9) (d) 3., Register, December, 1975, No. 240, eff. 1-1-76; am. table, (4) (c) 2 and (6) (e), Register, December, 1976, No. 252, eff. 1-1-77; cr. (2) (b) and (c), (3) (a) 3, am. (3) (b) (intro.), (4) (b) and (c) 1, (5), (7) (a), (c) and (e), (8) (b) and (9) (a) 1 and 2, r. and recr. (8) (b), Register, December, 1977, No. 264, eff. 1-1-78; am. (4) (c) 2., (5) (b), (6) (a) to (c), (7) (a) and (8) (c), Register, December, 1978, No. 276, eff.

1-1-79; am. (4) table, (5) (b), (9) (a) 1., (9) (c) 1. and 2., r. and recr. (3) and (8), cr. (9) (a) 3., Register, January, 1980, No. 289, eff. 2-1-80; cr. (8) (h), Register, December, 1981, No. 312, eff. 1-1-82; am. (8) (e), Register, October, 1982, No. 322, eff. 11-1-82; r. and recr. Table 52.04, (3), (6) (c), (7) and (9), am. (4) (b), (8) (c) and (8) (h) 1., cr. (10), Register, December, 1983, No. 336, eff. 1-1-84; am. (3) (a) (intro) and 2., (3) (c) 1. and (d) 1., (6) (a), (7) (a), Table 52.04-B and (8) (e), r. and recr. (3) (d) 3., Table 52.04-A, (7) (c), (8) (d) and (10) (d), renum. (8) (f) to (h) to be (8) (g) to (i), cr. (8) (f) and (11), r. (10) (e), Register, August, 1985, No. 356, eff. 1-1-86; reprinted to correct error in (11) (a) 3., Register, May, 1988, No. 389; r. and recr. (4) (b), Register, August, 1988, No. 392, eff. 9-1-88.

ILHR 52.041 Health care facilities — new construction. All new health care facilities shall be provided with access to a primary floor, interior circulation and toilet facilities in accordance with s. ILHR 52.04 and the following requirements:

(1) **ACCESSIBLE PATIENT TOILET FACILITIES.** Accessible patient toilet facilities shall be provided in accordance with this section.

(a) *Individual toilet facilities.* Where individual toilet facilities are provided in patient sleeping rooms or contiguous to patient sleeping rooms, at least 20% of these toilet facilities shall be usable by the disabled and shall comply with s. ILHR 52.04 (8). The accessible toilet facilities shall be integrated throughout the patient sleeping room area.

(b) *Centrally located toilet facilities.* Central toilet facilities serving the patient sleeping rooms shall be usable by the disabled and shall comply with s. ILHR 52.04 (8).

(c) *Toilet rooms located in ancillary areas.* Toilet rooms serving ancillary areas such as, but not limited to, physical therapy, occupational therapy, x-ray and similar occupancies shall be accessible and comply with distribution requirements specified in s. ILHR 52.04 (4) (c).

(2) **ACCESSIBLE PATIENT BATHING FACILITIES.** Accessible patient bathing facilities shall be provided in accordance with the following:

(a) *Individual bathing facilities.* Where individual bathing facilities are provided in patient sleeping rooms or contiguous to patient sleeping rooms, at least 20% of these bathing facilities shall be usable by the disabled and shall comply with s. ILHR 52.04 (8). The accessible bathing facilities shall be integrated throughout the patient sleeping room area.

(b) *Centrally located bathing facilities.* Central bathing facilities serving the patient sleeping rooms shall be usable by the disabled and shall comply with s. ILHR 52.04 (8).

History: Cr. Register, December, 1981, No. 312, eff. 1-1-82; cr. (1) (c), Register, December, 1983, No. 336, eff. 1-1-84.

ILHR 52.042 Existing health care facilities. (1) **ADDITIONS AND REMODELING.** Any addition to an existing health care facility or remodeling of an existing health care facility shall comply with the requirements specified in s. ILHR 52.04 (6) based on the percentage limitations and the requirements in this section.

(2) **TOILET AND BATHING FACILITIES.** Toilet and bathing facilities shall be provided in accordance with Table 52.042.

(a) *Additions.* Additions to existing health care facilities shall comply with s. ILHR 52.041.

(b) *Remodeling.* The remodeled or altered areas and portions of existing health care facilities shall comply with the requirements in Table 52.042.

TABLE 52.042
TOILET AND BATHING FACILITIES

Remodeling of Existing Health Care Facilities	Gross Interior Area of Entire Existing Building		
	Less than 25%	25-50%	More than 50%
Remodeling of existing patient sleeping rooms.	Toilet and bathing facilities being remodeled shall be accessible and comply with s. ILHR 52.04 (8).	20% of the patient sleeping rooms being remodeled shall be provided with accessible toilet and bathing facilities and shall comply with s. ILHR 52.04 (8).	20% of the total number of patient sleeping rooms of the entire building shall be provided with accessible toilet and bathing facilities and shall comply with ss. ILHR 52.04 (8) and 52.041.
Remodeling of ancillary areas (such as surgery, labs or similar areas), but no physical remodeling, additions, or both, to patient sleeping rooms.	Toilet and bathing facilities being remodeled shall be accessible and comply with s. ILHR 52.04 (8).	At least one toilet facility and bathing facility per 50 patients, but not less than one toilet facility and bathing facility per nursing station shall be available to both sexes and shall be accessible from a public corridor or public area.	

History: Cr. Register, December, 1981, No. 312, eff. 1-1-82.

ILHR 52.05 Size of courts. (1) In applying the following requirements, a building from 30 to 43 feet high shall be considered as having at least 3 stories, and each additional 13 feet shall be considered an additional story.

(2) Outer lot line courts shall be not less than 5 feet wide for a court 2 stories or less in height and 40 feet or less in length, measured from the lot line to the wall of the building. For each additional story in height, the width of such court shall be increased one foot; and for each additional 15 feet or fraction thereof in length, the width of such court shall be further increased one foot.

(3) Outer courts between wings or parts of the same building, or between different buildings on the same lot, shall be not less than 6 feet wide for a court 2 stories or less in height and 40 feet or less in length. For each additional story in height, the width of such court shall be increased one foot, and for each additional 10 feet or fraction thereof in length, the width of such court shall be further increased one foot.

(4) Where outer courts or outer lot line courts open at each end to a street or other open space not less than 15 feet wide, the above lengths may be doubled.

(5) Inner lot line courts one story high shall be not less than 5 feet wide and not less than 45 square feet in area. Inner lot line courts 2 stories high shall be not less than 6 feet wide and not less than 60 square feet in area. For every additional story, every such inner lot line court shall be increased by at least one lineal foot in length and one lineal foot in its width.

(6) Inner courts shall be not less than 10 feet in width nor less than 150 square feet in area for courts 2 stories or less in the height; and for every additional story every such inner court shall be increased by at least one lineal foot in its length and one lineal foot in its width.

(7) Courts shall not be covered by a roof or skylight but the entire required area shall be open and unobstructed from the bottom thereof to the sky. No fire escape or stairway shall be constructed in any court unless the court be enlarged proportionately.

(8) Walls of inner courts whose least horizontal dimension is less than one-fourth the height, shall be faced with material with a permanent white surface or shall be painted white at least every 2 years.

(9) No buildings shall be altered or enlarged to encroach upon space reserved under this code for light and air on the lots or parcels of ground on which such building is erected.

History: 1-2-56; am. (2) and (5), Register, September, 1973, No. 213, eff. 10-1-73.

ILHR 52.06 Ventilation of courts. At the bottom of every shaft or inner court there shall be sufficient access to such shaft or court to enable it to be properly cleaned out. Every inner court which is required under s. ILHR 52.02 and which is more than one story in height, shall have an intake for fresh air, leading from the street or other open space. The area of such intake in square feet shall equal at least .002 of the number of cubic feet contained in the court, but such area need not be more than 50 square feet. Every intake shall be of not less than 2-hour fire-resistive construction and unless the intake is used as a passageway for persons, there shall be no openings into the same other than the inlet and outlet.

History: 1-2-56; am. Register, December, 1981, No. 312, eff. 1-1-82.

FP ILHR 52.07 Atriums. (1) **SCOPE.** (a) Except as provided in par. (b), all buildings fully protected by an automatic fire sprinkler system may have atriums complying with the provisions of this section.

(b) High hazard buildings may not have atriums.

Note: See s. A 52.015 for further information regarding the classification and listing of high hazard buildings.

(2) **MINIMUM OPENING AND AREA.** Atriums shall have a minimum opening and area as specified in Table 52.07-1.

**Table 52.07-1
Atrium Opening and Area**

Height in Floor Levels	Minimum Clear Opening ¹ (Ft.)	Minimum Area (Sq. Ft.)
3-4	20	400
5-7	30	900
8 or more	40	1,600

¹ The specified dimensions are the diameters of inscribed circles whose centers fall on a common axis for the full height of the atrium.

(3) **SMOKE CONTROL SYSTEM.** (a) *General.* A mechanically operated air-handling system shall be installed that will exhaust smoke either entering or developed within the atrium.

Register, August, 1985, No. 356

(b) *Exhaust openings.* 1. Exhaust openings shall be located in the ceiling or in a smoke trap area immediately adjacent to the ceiling of the atrium.

2. The lowest level of the exhaust openings shall be located above the top of the highest portion of door openings into the atrium.

(c) *Supply openings.* Supply openings shall be sized to provide a minimum of 50 percent of the exhaust volume and shall be located with the bottom of the opening within 18 inches of the floor of the lowest level of the atrium.

(d) *Supply air.* 1. When the height of the atrium is 55 feet or less, supply air may be introduced by gravity, provided smoke control is accomplished.

2. When the height of the atrium is more than 55 feet, supply air shall be introduced mechanically from the floor of the atrium and be directed vertically toward the exhaust outlets.

3. In atriums over 55 feet in height or where tenant spaces above the second story are open to the atrium, supplemental supply air may be introduced at upper levels.

(e) *Systems activation and operation.* 1. The exhaust and supply system for the atrium shall operate automatically upon the actuation of either the automatic fire sprinkler system within the atrium or areas open to the atrium or by the actuation of 2 or more smoke detectors required by sub. (4), or both.

2. The exhaust and supply equipment shall also be manually operable by controls designed for fire department use.

3. The smoke-control system may be separate or integrated with other air-handling systems.

4. When the smoke-control mode is actuated, air-handling systems which would interfere with the smoke-control system shall be automatically shut down.

(f) *Smoke-control in spaces.* Spaces separated from the atrium but sharing a common wall shall be provided with a smoke-control system as follows:

1. The mechanical air-handling equipment for the tenant space may be designed to accomplish smoke removal;

2. Upon activation of the smoke detection or automatic fire sprinkler system within the space, the return and exhaust air shall be moved directly to the outside without recirculation to other sections of the building; and

3. The air handling system shall provide a minimum of 6 air changes per hour of exhaust air for the tenant space involved.

(g) *Sizing of smoke-control systems.* The atrium smoke-control system shall exhaust not less than the following quantities of air:

1. Atriums of 600,000 cubic feet or less. a. Except as provided in sub-par. b., a minimum of 6 air changes per hour but not less than 40,000

CFM for atriums having a volume of 600,000 cubic feet or less including the volume of any levels not physically separated from the atrium.

b. A lesser rate of air movement shall be acceptable provided it can be shown by test that smoke will not migrate beyond the perimeter of the atrium.

2. Atriums greater than 600,000 cubic feet. A minimum of 4 air changes per hour for atriums having a volume greater than 600,000 cubic feet including the volume of any levels not physically separated from the atrium.

(4) SMOKE DETECTION SYSTEM. (a) 1. An interconnected smoke detection system which will automatically operate the atrium smoke-control system shall be installed at the perimeter and on the ceiling of the atrium and on the ceiling of each floor level that is open to the atrium.

2. Smoke detectors shall be located within 15 feet of the atrium on floor levels open to the atrium.

(b) Smoke detection systems and individual smoke detectors shall be located and installed in accordance with their listing from a nationally recognized testing laboratory and s. ILHR 51.245.

(5) ENCLOSURE OF ATRIUMS. (a) *General*. 1. Except as provided in subd. 2., atriums shall be separated from adjacent spaces by at least one-hour fire-resistive rated construction.

2. Open exit balconies are permitted within the atrium.

3. The separation between the adjacent space and the atrium as specified in subd. 1. may be omitted on a maximum of any 3 floor levels, provided the remaining floor levels are separated as specified in subd. 1.

(6) OPENINGS IN THE ATRIUM ENCLOSURE. (a) *Door openings*. 1. Except as provided in subd. 2., openings in the atrium enclosure shall be protected by at least $\frac{3}{4}$ -hour, self-closing fire door assemblies as specified in s. ILHR 51.047.

2. The doors may be left open if equipped with an automatic closing device activated by products of combustion other than heat.

(b) *Fixed glazed openings*. Except as provided in subds. 1. and 2., fixed glazed openings shall be protected by at least $\frac{3}{4}$ -hour fire window assemblies as specified in s. ILHR 51.048 and the total area of the openings shall not exceed 25% of the area of the common wall between the atrium and the room into which opening is provided.

1. In ch. ILHR 57 residential occupancies, openings may be unprotected when the floor area of each guest room or living unit does not exceed 1000 square feet and each guest room or living unit has an approved exit not entering the atrium.

2. In all occupancies other than ch. ILHR 57 residential occupancies, the tenant space may be separated from the atrium by a wired, tempered or laminated glass wall, in a gasketed frame so installed that the glazing system may deflect without breaking the glass before the automatic fire sprinkler system operates.

(7) **EXITING.** (a) *Exit distance.* When a required exit enters the atrium space, the travel distance from the doorway of the tenant space to an enclosed stairway, horizontal exit, exterior door or exit corridor shall not exceed 100 feet. The maximum allowable exit distance, as required by chs. ILHR 54 to 62 shall also be met.

(b) *Prohibitions.* Sleeping rooms of ch. ILHR 58 health care facilities shall not be permitted to have required exits through the atrium.

(c) Except as provided in ss. ILHR 54.08, 55.09 and 57.08, unenclosed stairs within the atrium may not serve as required exit stairs.

(8) **OCCUPANCY SEPARATIONS.** (a) Except as provided in par. (b), at least an ordinary occupancy separation, as specified in s. ILHR 51.08, shall be provided between different occupancies.

(b) The vertical portion of the occupancy separation adjacent to the atrium may be omitted between:

1. Chapter ILHR 54 office and sales areas and ch. ILHR 57 guest rooms and living units located on another level;

2. Chapter ILHR 55 assembly halls without a stage and having an occupant load of less than 300 persons and ch. ILHR 57 guest rooms and living units located on another level; and

3. Chapter ILHR 54 office and ch. ILHR 55 assembly halls without a stage and having an occupant load of less than 300 persons.

(9) **STANDBY POWER.** The smoke-control system for the atrium and the smoke-control system for the tenant space shall be provided with emergency standby power as specified in s. ILHR 16.32.

(10) **INTERIOR FINISHES.** The interior finish of walls and ceilings of the atrium and all unseparated tenant spaces as permitted in sub. (6) (b) 3. shall be Class A. No reduction in class shall be permitted for automatic fire sprinkler system protection.

(11) **ACCEPTANCE OF THE SMOKE-CONTROL SYSTEM.** Before occupancy, the smoke-control systems shall be tested in an approved manner and shall show compliance with the requirements of this section.

Note: See Appendix A for a reprint of an approved test procedure.

(12) **INSPECTION OF THE SMOKE-CONTROL SYSTEM.** (a) All operating parts of the smoke-control systems shall be tested by an approved inspection agency or by the owner or designated agent or the smoke control system shall be fully supervised.

(b) The tests shall be made every 3 months and a log of the tests shall be kept. Fully supervised smoke control systems shall be tested at least annually.

(c) The log shall be on the premises and available for examination by department personnel or authorized deputies of the department.

History: Cr. Register, August, 1985, No. 356, eff. 1-1-86.

ILHR 52.19 Gas and oil lamps. (1) Gas and oil lamps shall not be used where electricity is available, except within living units of apartment buildings.

(2) Gas and oil lamps shall be placed at least 6 feet above the floor level, at least 6 inches from any combustible partition or wall, and at least 2 feet (measured from top of flame) below any combustible ceiling unless properly protected by a metal shield with at least 2 inches of air space above. Swinging brackets shall be provided with a guard or stop so that the light cannot come nearer to the partition or wall than one foot. In aisles and public passageways, every such light shall be protected by an incombustible guard unless the light is at least 7 feet above the floor. Gas and oil lights shall be kept at least 2 feet from any drape or window curtain.

(3) Every gas supply main shall have a service cock outside of the building, so placed and maintained that it can be shut off at any time without entering the building.

History: 1-2-56; am. (1), Register, September, 1973, No. 213, eff. 10-1-73.

FP ILHR 52.20 Electrical work. All electrical work shall conform to the requirements of the Wisconsin State Electrical Code, Volume 2, ch. ILHR 16, of the department.

Note: For the design requirements for transformer vaults, see ch. E 450 of the Wisconsin State Electrical Code, Volume 2, ch. ILHR 16.

History: 1-2-56; am. Register, January, 1961, No. 61, eff. 2-1-61.

FP ILHR 52.21 Location and maintenance of exits. Every exit mentioned in ss. ILHR 51.15 to 51.20, inclusive, shall lead to a street, alley or open court connected with a street. All such exits and all passageways leading to and from the same, shall be kept in good repair and unobstructed at all times.

History: 1-2-56; am., Register, January, 1980, No. 289, eff. 2-1-80.

FP ILHR 52.22 Repairs. Every building shall be kept in good repair and the roof shall be maintained to prevent leakage. All rainwater shall be so drained and conveyed to prevent dampness in the walls and ceilings.

History: Cr. Register, December, 1981, No. 312, eff. 1-1-82.

FP ILHR 52.23 Cleanliness. Every building, including connecting yards, courts, passages, areas or alleys, shall be kept clean, and shall also be kept free from any accumulation of dirt, filth, rubbish, garbage, or other matter.

History: Cr. Register, December, 1981, No. 312, eff. 1-1-82.

SANITATION REQUIREMENTS

ILHR 52.50 Toilet rooms. Every place of employment and public building shall have toilet rooms as provided in the occupancy classifications of this code, completely enclosed and so arranged as to ensure privacy, unless otherwise exempted.

History: 1-2-56; am. Register, December, 1962, No. 84, eff. 1-1-63; am. Register, December, 1976, No. 252, eff. 1-1-77.

ILHR 52.52 Sex designation. Where separate toilet rooms for each sex are required by this code, each toilet room shall be marked with regard to

the sex which uses it; words such as MEN or WOMEN, in letters not less than one inch high, or symbols may be used.

History: 1-2-56; am. Register, September, 1973, No. 213, eff. 10-1-73; am. Register, December, 1976, No. 252, eff. 1-1-77.

ILHR 52.53 Location, light and ventilation. (1) Every toilet or bathroom shall be so located as to open to outside light and air, by windows or skylights opening directly upon a street, alley or court, except as provided in s. ILHR 52.54.

(2) The glass area for a toilet room containing one water closet or urinal shall be at least 4 square feet with at least 2 square feet openable.

(a) Bathrooms containing a water closet or urinal shall be considered as a toilet room.

(3) No toilet room shall have windows or ventilator openings in any elevator shaft or inner court that has windows of habitable rooms above.

(4) Every toilet room having more than one fixture including closets and urinals shall be ventilated in accordance with the provisions of s. ILHR 64.65, except that this requirement shall not apply to chemical or septic toilets which are installed in accordance with the provisions of the chemical toilet code or the septic toilet code issued by the department.

(a) The size of gravity vent ducts, if surmounted with effective siphon type hoods, may be determined as follows: $\frac{A \times 2}{300}$ = net cross sectional area of vent duct in square feet.

Where A = floor area in the toilet room in square feet.

History: 1-2-56; am. Register, December, 1962, No. 84, eff. 1-1-63; r. and recr. Register, October, 1967, No. 142, eff. 11-1-67; am. (3), Register, September, 1973, No. 213, eff. 10-1-73; am. (4) (intro.), Register, December, 1975, No. 240, eff. 1-1-76; am. (4), Register, December, 1981, No. 312, eff. 1-1-82.

ILHR 52.54 Location without outside windows; when permitted. (1) SINGLE FIXTURE TOILET ROOMS AND BATHROOMS. (a) Except as provided in par. (b), windows may be omitted in bathrooms or toilet rooms having one water closet or urinal and lavatory or bathing facility where artificial light and either mechanical exhaust ventilation or an approved ductless air circulating and treatment device is provided.

(b) The use of ductless air circulating and treatment devices in taverns and restaurants is prohibited.

(2) MULTIPLE FIXTURE TOILET ROOMS. Toilet rooms with more than one fixture (water closet or urinal) will be permitted without windows if mechanical ventilation, in accordance with the requirements of s. ILHR 64.65, and artificial light are provided.

History: 1-2-56; r. and recr. Register, October, 1967, No. 142, eff. 11-1-67; am. Register, December, 1975, No. 240, eff. 1-1-76; r. and recr. Register, December, 1977, No. 264, eff. 1-1-78; am. (1), Register, December, 1983, No. 336, eff. 1-1-84.

ILHR 52.55 Artificial light. Every toilet room, except those within living units, shall be artificially lighted during the entire period that the building is occupied, wherever and whenever adequate natural light is not available, so that all parts of the room, especially the toilet compart-

ments, shall be provided with artificial light intensity of not less than 2.5 footcandles at the floor level.

History: 1-2-56; am. Register, September, 1973, No. 213, eff. 10-1-73.

ILHR 52.56 Size. Every toilet room shall have at least 14 square feet of floor area with a minimum width of 3 feet, and at least 100 cubic feet of air space for each water-closet and each urinal in addition to the space required for lavatories if installed within the toilet room.

ILHR 52.57 Floor and base. Every toilet room, except those within living units of apartment buildings, shall have the entire floor and the side walls to a height of not less than 4 inches made waterproof with ceramic tile, terrazzo, painted concrete, marble slate, monolithic asphalt or other approved material impervious to water.

Note: This section is also intended to prohibit the use of wall registers within 4 inches of the floor, baseboard registers and floor registers.

History: 1-2-56; am. Register, September, 1973, No. 213, eff. 10-1-73; am. Register, December, 1981, No. 312, eff. 1-1-82.

ILHR 52.58 Walls and ceilings. (1) The walls and ceilings of every toilet room shall be completely covered with smooth non-absorbent material.

(2) The interior surface of walls and partitions shall be of light color to improve illumination and facilitate cleaning.

History: 1-2-56; r. and recr. Register, September, 1959, No. 45, eff. 10-1-59; am. (1), Register, December, 1977, No. 264, eff. 1-1-78.

ILHR 52.59 Enclosure of fixtures. (1) The fixtures (closets and urinals) in every toilet room shall be arranged to ensure privacy. Water-closets shall be enclosed with partitions. Urinals shall be placed against walls and arranged individually. Individual floor type urinals shall be placed against walls at least 7 feet 0 inches high.

(a) *Exception.* The above requirements need not apply to toilet rooms accommodating only a single closet or urinal.

(2) A space of 6 to 12 inches shall be left between the floor and the bottom of each partition. The top of the partition shall be from 5½ to 6 feet above the floor. Doors with the top 5½ to 6 feet above the floor, and the bottom 6 to 12 inches above the floor, shall be provided for all water-closet compartments. All partitions and doors shall be of material and finish required for walls and ceilings under s. ILHR 52.58.

(3) The water closet compartments in toilet rooms shall be not less than 30 inches in width, and shall be not less than 54 inches in depth with a clearance of not less than 24 inches between the fixture and the compartment door when closed except as specified in s. ILHR 52.04 (8). Compartment doors which are hung to swing inward shall clear the fixture not less than 2 inches.

(4) No admission fee shall be charged for the use of any toilet facility in a public building or place of employment. Key-locking of toilet rooms is
Register, August, 1985, No. 356

prohibited in all buildings except service stations and filling stations having exterior toilet room access.

Note: Section 146.085, Stats., prohibits charging a fee for the use of toilet facilities and imposes a fine of \$10 to \$50 for violations.

History: 1-2-56; am. (3) and cr. (4), Register, November, 1963, No. 95, eff. 12-1-63; am. (2), Register, February, 1974, No. 218, eff. 3-1-74; r. (4), Register, December, 1974, No. 228, eff. 1-1-75; am. (3), Register, December, 1975, No. 240, eff. 1-1-76; cr. (4), Register, December, 1976, No. 252, eff. 1-1-77; am. (1), Register, December, 1977, No. 264, eff. 1-1-78.

ILHR 52.60 Fixtures. (1) WATER CLOSETS. Only water closets of porcelain, vitreous china, stainless steel or other nonabsorbent materials shall be used. All water closets in public buildings and places of employment shall have elongated bowls and hinged, open-front seats without cover. Water closets in apartments, day care centers, individual executive offices, and sleeping units of hotels and motels may be of the round bowl type, provided with a hinged, closed-front seat, with or without cover. Water closets shall be equipped to limit the use of water to not more than 4 gallons per flush.

(2) **URINALS.** (a) *Stall type.* Stall-type urinals shall be set into the floor, and the floor shall be graded toward the fixture. Spaces between stall-type urinals, or urinals and sidewalls, shall be filled in flush with the front and top of the urinal with nonabsorbent material if the space is less than 12 inches.

(b) *Wall type.* Wall-hung urinals may be installed in all buildings except elementary schools (kindergarten through 8th grade).

Note #1: The definitions and general classifications for schools are found in s. 115.01, Stats.

Note #2: The department recommends that wall-hung urinals be installed at a height between 22 inches to 24 inches above the floor.

Note #3: See s. ILHR 52.04 (8) for additional requirements dealing with making wall-hung urinals accessible for people with disabilities.

(c) *Flushing devices.* The urinals shall be equipped with an effective flushing device which limits the use of water to not more than 1.5 gallons per urinal per flush.

(d) *Multiple urinals.* Batteries of urinals shall be spaced not less than 30 inches center-to-center. The center line of a single urinal shall be at least 16 inches from the nearest sidewall or partition.

(e) *Materials.* Only individual urinals of porcelain, vitreous china, stainless steel, or other nonabsorbent materials approved by the department shall be used.

(3) HAND-WASHING AND DRYING FACILITIES. Hand-washing facilities shall be provided in all places of employment and public buildings in accordance with the requirements of this subsection.

(a) *Lavatories.* Except as provided in sub. (6), lavatories shall be of an approved type and shall be provided with hot and cold running water. The faucets of such lavatories shall be of a type which limits the flow of water through the faucet, after the handle is released, to not more than one gallon. Lavatories in toilet rooms of private living units shall be equipped to limit the flow of water to not more than 3 gallons per minute. The lavatories may be equipped with a hot and cold regulating device. If a multiple-use lavatory is installed, 24 lineal inches of wash sink or 20

inches measured along the edge of a circular basin will be considered equivalent to one lavatory.

(b) *Hand-drying facilities.* Individual hand towels, sections of cloth or paper, or clean individual sections of continuous toweling, convenient to the lavatories, shall be provided. Hand-drying facilities shall be provided at the ratio of at least one unit for every 3 lavatories. Warm-air blowers may be substituted for up to one-half of the required hand-drying units. Warm-air blowers shall provide air at not less than 90° F, nor more than 140° F.

Note: The department will accept the qualified blowers listed by Underwriters' Laboratories, Inc.

(c) *Toilet soap.* Soap or similar cleansing agents shall be provided.

(d) *Receptacles.* Receptacles shall be provided for the disposal of used towels and other waste materials.

(4) **DRINKING FACILITIES.** Drinking facilities shall be provided in all buildings except in areas where food and drinks are served. Drinking facilities shall not be installed in toilet rooms, except in residential occupancies. Drinking fountains, coolers or individual cups at a potable water source may be provided. Common drinking cups are prohibited.

Note: Where running water is not available, a covered drinking water container, equipped with a faucet or bubbler, may be provided. The container should be cleaned and sanitized at frequent intervals.

(5) **BATHING FACILITIES.** Bathing facilities shall be provided for the specific occupancies outlined in the occupancy chapters of this code.

(a) All shower compartments, regardless of shape, shall have at a minimum finished interior of 900 square inches and shall be capable of encompassing a 30-inch circle. The minimum required area and dimension shall be measured at a height 24 inches above the top of the threshold and at a point tangent to its centerline. The minimum area and dimensions shall be maintained to a point 70 inches above the shower waste outlet with no protrusions other than the fixture valve or valves, showerheads, soap dishes and safety grab bars or rails. Each shower room or compartment shall be constructed of material impervious to moisture. The floor of the shower room or compartment shall be provided with a slip-resistant finish.

(b) *Hot and cold water.* Except as provided in sub. (6), bathing facilities shall be provided with hot and cold water and be equipped with a hot and cold water regulating device. The device shall be plainly marked. Supply or feed pipes to showers shall be placed overhead or protected to avoid the probability of a person coming in contact with the hot water pipes. Showers shall be equipped to limit the flow of water to not more than 3 gallons per minute per shower head.

(c) *Toilet soap and towels.* Employes who use showers shall be provided with soap or other appropriate cleansing agents and clean individual towels.

Note: See ch. ILHR 82 for special fixture requirements.

(6) **LAVATORIES, USE OF HOT OR TEMPERED WATER.** (a) Lavatories, wash fountains and shower heads which are not located in dwelling units or living units shall be supplied with either tempered water or hot water.

1. Tempered water shall be provided to lavatories, wash fountains and shower heads by means of tempering mixing valves.

2. No more than 4 lavatories which are located in the same room may be served by a single tempering mixing valve.

3. Only shower heads which are located in the same room may be served by a single tempering mixing valve.

(b) Lavatories located in park shelters and bath houses which are not open during the period from November 15 to March 15 and which are not places of employment shall not be required to be provided with hot water.

(c) Lavatories located in waysides which are not places of employment shall not be required to be provided with hot water.

Note: The exception of providing hot water under pars. (a) to (c) does not supercede the requirements of other state agencies for providing hot water.

History: 1-2-56; r. and recr., Register, September, 1959, No. 45, eff. 10-1-59; am. (1), Register, September, 1973, No. 213, eff. 10-1-73; r. and recr., Register, December, 1974, No. 228, eff. 1-1-75; am. (1) and (2) (d), r. and recr. (2) (b), cr. (2) (f), (3), (4) and (5), Register, December, 1976, No. 252, eff. 1-1-77; am. (2) (c), Register, May, 1978, No. 269, eff. 6-1-78; am. (1), (2) (c), (3) (a) and (5) (b), Register, January, 1980, No. 289, eff. 2-1-80; r. (2) (f), r. and recr. (5) (a), Register, August, 1985, No. 356, eff. 1-1-86; am. (3) (a) and (5) (b), cr. (6), Register, May, 1988, No. 389, eff. 6-1-88.

ILHR 52.61 Protection from freezing. All water-closets and urinals and the pipes connecting therewith shall be properly protected against freezing, so that such water-closets and urinals will be in proper condition for use at all times.

ILHR 52.62 Disposal of sewage. (1) Each water-closet and urinal, and each lavatory or slop sink, located in a toilet room shall be connected with a sewer and water system, where such systems are available. In locations where a sewer system is not available, or cannot be made available, the disposal of human waste may be accomplished as follows:

(a) Sewage treatment tank and disposal system; or

Note: For detailed requirements on such systems see ch. ILHR 82.

(b) Where the local conditions make it impractical to install such system, outdoor toilets, as described in s. ILHR 52.63, or other facilities, such as septic toilets installed in accordance with the provisions of the septic toilet code issued by the department may be used; provided that in the case of places of employment for more than 10 persons, schools larger than 2 rooms, and apartment houses, water-flush toilets as herein described shall be provided, unless outdoor toilets or other facilities are permitted in writing by the department.

ILHR 52.63 Outdoor toilets. (1) Outdoor toilets shall comply with ss. ILHR 52.50 to 52.59, inclusive, and in addition:

(a) No privy, with or without a leaching pit or other container, shall be erected or maintained within 50 feet of any well, 10 feet of the line of any street or other public thoroughfare, 5 feet of the property line between premises or 25 feet of the door or window of any building;

(b) Located on ground that is well drained, and where there is no possibility of contaminating any drinking water supply;

(c) Provided with suitable approach, such as concrete, gravel or cinder walk;

(d) The foundations shall be of concrete or other masonry;

(e) The vault shall extend at least 6 inches above ground, be as dark as possible, and be proof against entrance by flies, rats, or other vermin. The upper portion shall be of concrete, or of brick or stone laid in cement mortar. If in poorly drained soil, the entire vault shall be of concrete, or brick, or stone, laid in cement mortar;

(f) All windows, ventilators and other openings shall be screened to prevent the entrance of flies, and all doors shall be self-closing. A separate ventilator shall be provided for the vault and shall extend from the vault to not less than one foot above the roof and be provided with an effective ventilating hood; and

(g) The entire installation shall be kept clean and sanitary. Milk of lime (freshly slaked lime) or other equally effective disinfectant shall be used in the vault and in the urinal trough in sufficient quantities, and at frequent intervals. The floors, seats and urinals shall be scrubbed as often as necessary. The vault shall be cleaned out at proper intervals.

ILHR 52.64 Maintenance and housekeeping. (1) **MAINTENANCE OF TOILETS.** Every toilet room, and every part thereof, including walls, floor, ceiling and fixture therein, shall be kept clean, efficient, and in good repair.

(2) **PAPER.** In every toilet room, sufficient toilet paper made of material which will not interfere with the operation of the system or obstruct the fixtures, shall be provided.

(3) **DEFACEMENT.** Indecent or suggestive marks, pictures, or words are forbidden in toilet rooms, and such defacement when found shall be removed at once.

(4) **SERVICE CLOSETS.** In buildings having 5 or more fixtures (water closets and/or urinals) a service closet shall be provided conforming with the requirements for toilet rooms.

(a) The service closet shall be supplied with mop, broom, bucket, soap, toilet paper, toweling and other equipment for sanitary upkeep of toilet rooms.

History: 1-2-56; r. and recr. (4), Register, October, 1967, No. 142, eff. 11-1-67.

Chapter ILHR 53

STRUCTURAL REQUIREMENTS

- ILHR 53.01 Scope (p. 139)
Part I Minimum Allowable Loads
ILHR 53.10 Dead loads (p. 139)
ILHR 53.11 Live loads (p. 140)
ILHR 53.12 Wind loads (p. 144)
ILHR 53.13 Impact loads (p. 145)
ILHR 53.14 Horizontal crane forces (p. 146)
ILHR 53.15 Load combinations (p. 146)
ILHR 53.16 Stability (p. 146)
ILHR 53.17 Interior nonload-bearing walls and partitions (p. 146)
Part II Foundations
ILHR 53.20 General (p. 147)
ILHR 53.21 Soil bearing capacity (p. 147)
ILHR 53.22 Unprepared fill material, organic material (p. 147)
ILHR 53.23 Frost penetration (p. 148)
ILHR 53.24 Piling (p. 148)
ILHR 53.25 Settlement (p. 150)
ILHR 53.26 Protection of adjoining property (p. 150)
ILHR 53.27 Cut or fill slopes (p. 151)
ILHR 53.28 Pole foundations (p. 151)
Part III Masonry
ILHR 53.30 General (p. 152)
ILHR 53.31 Materials (p. 153)
ILHR 53.311 Masonry units (p. 153)
ILHR 53.312 Mortar (p. 155)
ILHR 53.313 Masonry grout (p. 157)
ILHR 53.314 Cementitious materials (p. 157)
ILHR 53.315 Water (p. 157)
ILHR 53.316 Reinforcing, ties and anchors (p. 157)
ILHR 53.32 Design (p. 158)
ILHR 53.321 Types of masonry (p. 158)
ILHR 53.322 Empirical method of design (p. 159)
ILHR 53.323 Engineered masonry (p. 168)
ILHR 53.33 Construction (p. 169)
ILHR 53.34 Miscellaneous design-construction details (p. 169)
ILHR 53.35 Tests (p. 172)
ILHR 53.36 Veneer, furring and trim (p. 173)
Part IV Concrete
ILHR 53.40 Concrete requirements (p. 174)
ILHR 53.41 Gypsum concrete requirements (p. 175)
ILHR 53.42 Vermiculite concrete requirements (p. 175)
Part V Metals
ILHR 53.50 Structural steel requirements (p. 175)
ILHR 53.51 Cold-formed steel requirements (p. 176)
ILHR 53.52 Steel joist requirements (p. 176)
ILHR 53.53 Structural welding of steel (p. 176)
ILHR 53.54 Aluminum framing requirements (p. 178)
ILHR 53.55 Stainless steel requirements (p. 178)
ILHR 53.56 Steel cable requirements (p. 178)
ILHR 53.57 Other metals (p. 179)
Part VI Wood and Wood Fiber Products
ILHR 53.60 General (p. 179)
ILHR 53.61 Materials and design of structural elements (p. 179)
ILHR 53.62 Special systems (p. 182)
ILHR 53.63 Minimum construction requirements (p. 182)
ILHR 53.64 Wood foundations (p. 185)

History: Chapter Ind 53 as it existed on December 31, 1974, was repealed and a new chapter Ind 53 was created Register, July, 1974, No. 223, effective January 1, 1975; chapter Ind 53 was renumbered to be chapter ILHR 53 effective 1-1-84.

ILHR 53.01 Scope. This chapter provides the minimum requirements for the structural design of all buildings, structures and foundations to provide safe support of all dead loads, superimposed live and special loads, without exceeding the prescribed allowable stresses or departing from accepted engineering practice.

Note: Chs. Ind 1000-2000, Safety and Health, provides requirements for the safe assembly of materials at the construction site.

Note: References. All standards referred to in this chapter will be identified by the designation and the number of standard followed by a cross-reference. The cross-reference will give full detail of the subject name and year of standard. Example: ASTM C-55 [ILHR 51.25 (16)].

History: Cr. Register, July, 1974, No. 223, eff. 1-1-75.

Part I — Minimum Allowable Loads

ILHR 53.10 Dead loads. All buildings and structures, and parts thereof, shall be designed and constructed to support the actual dead weight of all

component members in addition to the weight of partitions, ceiling finishes, floor finishes, stairways, safes and service equipment such as sprinkler systems, plumbing stacks, heating and air conditioning equipment, electrical equipment, elevators, flues and similar fixed equipment which become a part of the building.

Note: Unless the project owner submits a written application for waiver, the department will consider 3 pounds per square foot as minimum service equipment load.

History: Cr. Register, July, 1974, No. 223, eff. 1-1-75.

ILHR 53.11 Live loads. (1) All buildings and structures, and parts thereof, shall be designed and constructed to support the superimposed live loads, specified in Table 53-I, uniformly distributed in pounds per square foot of horizontal area. These load requirements shall be considered only as a minimum. In every case where the loading is greater than this minimum, the design of the building or structure, or part thereof, shall be for the actual load and loading conditions. The most severe distribution, concentration and combination of design loads and forces shall be taken into consideration.

TABLE 53-I
FLOOR LOADINGS

Occupancy	PSF
(a) Business	
1. Offices	50
2. Offices with heavy business machines, heavy files, book stacks	100
(b) Mercantile	
1. Retail stores, shops, banks, restaurants, taverns, funeral homes	100
2. Wholesale stores	125
(c) Industrial	
1. Manufacturing, light	100
2. Manufacturing, heavy	150
(d) Storage	
1. Warehouse, light.....	125
2. Warehouse, heavy.....	250
3. Paper storage	
a. Compact	50 psf per ft. of ht.
b. Loose	30 psf per ft. of ht.
4. Garages—storage or repair.....	80
or 8,000 pound axle load in any possible position (which ever produces larger stresses).	
5. Parking decks	
a. All areas for passenger cars	50
b. Top floors, if open to sky, shall be designed for 50% of the roof load specified in sub. (4) in addition to	50
c. Express lanes and ramps with a slope of 12% or more, the vertical loading (50 psf) shall be increased by 25%	

TABLE 53-I Continued

Occupancy	PSF
d. All areas for trucks and buses80 or 8,000 pound axle load in any possible position (whichever produces larger stresses)	
(e) Assembly areas	
1. Armories, drill rooms150	
2. Assembly halls, auditoriums, lecture halls, churches, lodge rooms, theaters, courtrooms, balconies, with:	
a. Fixed seats.....60	
b. Movable seats.....100	
3. Dance floors gymnasiums, exhibition rooms, passenger sta- tions, skating rinks, restaurant serving and dining areas.....100	
4. Recreational areas such as bowling alleys and pool rooms ...75	
5. Floors supporting portable reviewing stands and assembly seating facilities with vertical dead load less than 15 pounds per square foot.....100	
6. Stage floors150	
7. Floors supporting portable reviewing stands and assembly seating facilities with vertical dead load of 15 pounds per square foot or more.....100 plus the actual vertical dead load of reviewing stand or assembly seating facility	
(f) Educational	
1. Schools and related facilities	
a. Classrooms, study rooms, laboratories, display areas, offices50	
b. Floors of open plan schools75	
c. Industrial arts, home economics, music and band rooms.....80	
d. Gymnasiums, cafeteria areas.....100	
2. Libraries (public or in schools)	
a. Reading areas60	
b. Stack areas (20 psf per foot of height) but not less than .150	
3. Museums and art galleries80	
(g) Residential	
1. Apartments, dormitories, guest rooms in hotels and motels.....40	
2. Storage in apartment buildings80	
(h) Institutional	
1. Ward and private rooms in hospitals, nursing homes, asylums, cells in penal institutions.....40	
2. Operating rooms in hospitals, clinics60	
(i) Miscellaneous (applies to all occupancies above)	
1. Stairways, corridors, vestibules, lobbies	
a. in residential and institutional buildings80	
b. in all other buildings100	
2. Rest rooms and toilet rooms in public places50	
3. Equipment rooms (heating-ventilating, mechanical, elec- trical) equipment weight plus 40 psf, but not less than75	

TABLE 53-I Continued

Occupancy	PSF
4. Structural sidewalks and promenade decks	
a. with no vehicular restriction	250
or 12,000 pounds concentrated load in any position	
b. with vehicular restriction	100
5. Walkways and elevated platforms, other than exitways, and their supports serving as access to equipment rooms and other normally unoccupied areas	60
6. Accessible, nonstorage attics and catwalks.....	25

(2) Loads not specified in Table 53-I. See s. ILHR 53.11 (1).

(3) Live load reductions.

(a) No reduction of live load shall be allowed in the design of any slab or joist.

(b) No reduction of live load shall be allowed in the occupancies mentioned in Table 53-I pars. (d) storage and (e) assembly areas.

(c) For determining the total live load carried by foundations, columns, piers, and walls, the following reductions can be applied to the entire floor area tributary to these members:

carrying the roof.....	0%	carrying 5 floors and roof.....	30%
carrying 1 floor and roof	0%	carrying 6 floors and roof.....	35%
carrying 2 floors and roof.....	10%	carrying 7 floors and roof.....	40%
carrying 3 floors and roof.....	20%	carrying 8 floors and roof.....	45%
carrying 4 floors and roof.....	25%	carrying 9 or more floors and roof.....	50%

(d) Except for roofs, a reduction in live load of one % per 20 square feet is allowed for beams and girders which have a tributary area in excess of 150 square feet. The maximum reduction should not exceed 15% and such reduction shall not be carried into the structural members supporting these beams and girders.

(4) ROOF LOADS. Roof structural members subject to snow accumulation shall be designed for all of the following roof load distributions.

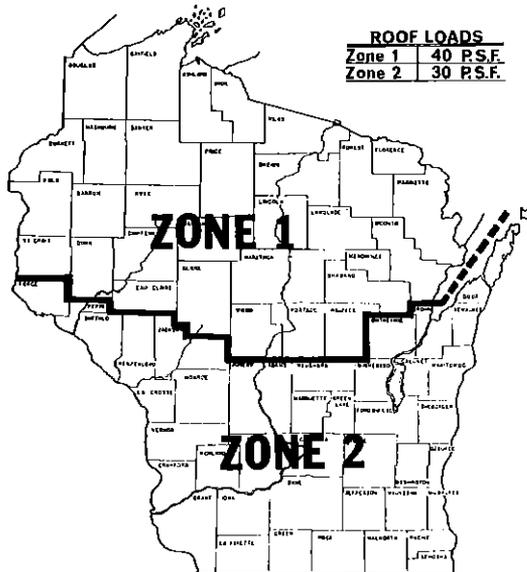

Zone Map for Roof Loads

(a) 1. Except as provided in subd. 2., full load as indicated in the zone map for roof loads distributed over the entire area. The loads shall be applied to the horizontal projection of the roof.

2. a. Roofs, except of greenhouses, with an unobstructed slippery surface such as glass, plastic, metal, slate or similar material that will allow snow to slide off the eaves and having a slope (α) exceeding 30° , may be designed for a load determined by multiplying the roof load specified in par. (a) (intro), by a slope factor (C_R) using the following formula:

$$C_R = 1.0 - \left(\frac{\alpha - 30^\circ}{40^\circ} \right)$$

b. Roofs of greenhouses shall comply with the requirements of s. ILHR 62.96.

(b) Unbalanced or partial loading for the following conditions:

1. Full load on the leeward side and one-half load on the windward side of sloped roofs having a pitch of 15° or more;

2. Full load on the end span of continuous purlin members having a tributary area of 200 square feet or less and one-half on the remaining spans; and

3. a. Except as provided in subpar. b., full load on any one portion of the roof area and one-half on the remaining portion of the roof area, in a

manner to produce the greatest effects on cantilever members and the anchor spans.

b. Cantilever roof framing design shall include anchorage and supports capable of providing stability for full load applied on the cantilever without relying upon possible live load on the anchor span. Where a canopy roof is cantilevered on both sides of a single line of columns, the columns and foundation shall be designed for full load on the portion of the roof on one side of the column line and no load on the other side.

(c) * Nonuniform load caused by excess snow, ice or water accumulation at roof level elevation differences, parapets, canopies, valleys and similar areas.

1. The nonuniform snow loading shall be determined by multiplying the indicated roof load by a snow load coefficient (C_S) appropriate for the roof area considered.

$$S = C_S g$$

where S = design snow load, psf

g = roof live load as indicated in the zone map for roof loads
[see par. (a)]

C_S = snow load coefficient

Note: Acceptable snow load distribution and coefficients (C_S) for typical roof configurations are given in Appendix A. Additional information can be found in the "Commentary on Snow Loads," in supplement No. 4 to the National Building Code of Canada.

2. The roof load shall be increased to account for the accumulation of drifting snow on the lower of multi-level roofs if the upper roof is part of the same building or of an adjacent building not more than 15 feet away.

(d) * 1. Roof designs incorporating storm drain sizes less than those specified in s. ILHR 82.36 (4) and (5), shall be investigated by calculation to determine if stability of the building or structure due to ponding is achieved.

2. When roof drains are needed to remove precipitation and are the sole means of water escape, there shall be placed in all parapet walls, scuppers or relief openings to prevent overloading of the roof.

History: Cr. Register, July, 1974, No. 223, eff. 1-1-75; am. (3) (d) and (4) (a), Register, December, 1974, No. 228, eff. 1-1-75; am. (1) (d) 5 b, Register, December, 1977, No. 264, eff. 1-1-78; r. and recr. (4), Register, January, 1980, No. 289, eff. 2-1-80; am. (1) (d) 5. b. and (e) 5., cr. (1) (e) 7. and (4) (e), r. and recr. (4) (a) 1., Register, December, 1981, No. 312, eff. 1-1-82; cr. (1) (g) 2., (i) 5. and 6., r. and recr. (4) (a) and (b), r. (4) (c), renun. (4) (d) and (e) to be (4) (c) and (d), Register, December, 1983, No. 336, eff. 1-1-84; correction in (4) (d) made under s. 13.93 (2m) (b) 7, Stats., Register, August, 1985, No. 356.

ILHR 53.12 Wind loads. (1) **LOADING.** Every building (including all components of the exterior wall) and structure shall be designed to resist a minimum total wind load in accordance with the following table:

Up to 50 feet	20 psf
Over 50 to 100 feet	25 psf
Over 100 to 150 feet	30 psf

* See Appendix A for further explanatory material.

Over 150 to 200 feet	35 psf
Over 200 feet	40 psf

The wind pressure shall be taken on the gross area of the vertical projection of the building or structures facing the wind. No allowance shall be made for the shielding effect of other buildings and structures. For purposes of wind load design, the height shall be measured above the average level of the adjoining ground.

(2) UPLIFT AND SUCTION FORCES. Buildings and structures, including attachment of roof to building or structure and anchorage of building or structure to the foundation, shall be designed and constructed to withstand a wind pressure acting outward normal to the surface equal to the values set forth in sub. (1). These suction and uplift forces need not be considered as additive to the design wind loads in the overall analysis of the building or structure. Roof overhangs, eaves, cornices, canopies and buildings open on one or more sides shall be designed and constructed to withstand an upward pressure of at least 30 PSF, unless a higher value is indicated in sub. (1).

(3) OVERTURNING MOMENT. The overturning moment due to wind load shall not exceed $\frac{1}{3}$ of the moment of stability due to dead load only, unless the building or structure is anchored to foundations of sufficient weight to resist this force. The weight of earth superimposed over footings may be used to calculate the dead load resisting moment. Sufficient diaphragm bracing, diagonal bracing or rigid connections between uprights and horizontal members shall be provided to resist distortions.

(4) SHAPE FACTORS. The following shape factors may be used for the design of structures such as chimneys, tanks and solid towers in conjunction with sub. (1).

<i>Horizontal cross-section</i>	<i>Shape factors</i>
square or rectangular	1.0
hexagonal or octagonal.....	0.8
round or elliptical.....	0.6

(5) WIND LOAD ANALYSIS. More exact wind load analysis will be acceptable if a recognized procedure is used.

Note: The department will accept recognized procedures such as, but not limited to Department of Navy, Bureau of Yards and Docks, NAVFAC DM-2 (Dec. 1967); or "Wind Forces on Structures," by the Structural Division of ASCE Test Committee on Wind Forces (ASCE Transactions, Vol. 126, Part II, Paper No. 3269).

History: Cr. Register, July, 1974, No. 223, eff. 1-1-75; am. (2), Register, December, 1976, No. 252, eff. 1-1-77.

ILHR 53.13 Impact loads. Structural elements carrying live loads which induce impact shall have the live loads increased by the following minimum percentages in the structural design consideration of the forces:

For supports of elevators.....	100
For traveling crane support girders, monorail supports, and their connections:	
Cab operated cranes	25
Top running pendant operated cranes.....	10
Underhung and monorail cranes	25

For supports of light machinery	20
For supports of vibrating machinery or power driven units	50
For hangers supporting floors and balconies	33

History: Cr. Register, July, 1974, No. 223, eff. 1-1-75; r. and recr. (1), renum. (2) to be 53.14, Register, December, 1977, No. 264, eff. 1-1-78; am. Register, December, 1983, No. 336, eff. 1-1-84.

ILHR 53.14 Horizontal and longitudinal crane forces. The lateral force on crane runways shall be equal to 20% of the sum of the crane capacity and the crane trolley (but exclusive of other parts of the crane). The force shall be assumed to be applied at the top of the rail, one-half on each side of the runway, and shall be considered acting in either direction normal to the runway rail. The longitudinal force (in the direction of rail) shall be taken as 10% of the maximum wheel loads of the crane applied at the top of the rail.

History: Cr. Register, July, 1974, No. 223, eff. 1-1-75; renum. from 53.13 (2), Register, December, 1977, No. 264, eff. 1-1-78.

ILHR 53.15* Load combinations. Allowable stresses may be increased 33½% when wind loads are acting in combination with dead, live and impact (if any) loads. The section computed on this basis shall be not less than that required for the design dead, live and impact (if any) loads, computed without the 33½% stress increase. The most severe distribution, concentration and combination of design loads and forces shall be taken into consideration, as specified in s. ILHR 53.11.

History: Cr. Register, July, 1974, No. 233, eff. 1-1-75, am. Register, December, 1975, No. 240, eff. 1-1-76; renum. from 53.14, Register, December, 1977, No. 264, eff. 1-1-78.

ILHR 53.16 Stability. (1) **GENERAL.** (a) Provisions shall be made to assure stability of the structure as a whole and lateral, torsional and local stability of all structural parts.

(b) Instability, including sway effects or lateral displacement, produced by vertical loads or vertical and lateral loads acting on the structure shall be taken into account in the design of all structures and structural members.

(2) **CALCULATIONS AND TESTING.** (a) Calculations verifying structural stability shall be submitted under s. ILHR 50.12 (4) (a) and (b) when requested.

(b) Bracing systems, for which the strength and stiffness cannot be calculated, shall be substantiated by test reports.

History: Cr. Register, December, 1983, No. 336, eff. 1-1-84.

ILHR 53.17 Interior nonload-bearing walls and partitions. Interior nonload-bearing walls and permanent partitions more than 6 feet in height shall be designed to resist a lateral load of not less than 5 pounds per square foot of wall area. Movable or folding partitions are not required to meet the load criteria but shall be anchored to the supporting structure if their height exceeds 6 feet.

History: Cr. Register, December, 1983, No. 336, eff. 1-1-84.

*See Appendix A for further explanatory material.

Part II — Foundations

ILHR 53.20 General. All submittals for plan examination of new buildings or structures, and for the alteration of a permanent structure which requires changes in foundation loads and distribution, shall have the soil types and bearing capacities (indicating verified or presumptive) used in the design of footing and foundations shown on the plans. Sufficient records and data to establish the soil character, nature and load-bearing capacity shall be available to the department upon request.

History: Cr. Register, July, 1974, No. 223, eff. 1-1-75.

ILHR 53.21 Soil bearing capacity. Bearing capacity of soils shall be determined by one of the following methods:

(1) **VERIFIED.** The soil shall be subjected to field or laboratory tests to determine its bearing capacity. A report, certified by a registered architect or registered professional engineer, shall be available to the department upon request.

(2) **PRESUMPTIVE.** (a) The type of soil under buildings shall be assigned a value not exceeding the bearing capacity, in pounds per square foot, as specified in Table 53-II. The type of soil shall be determined by explorations made at or adjacent to the site. The actual loading of the soil shall not exceed the specified bearing capacity unless verified by a written report as explained in sub. (1).

**TABLE 53-II
 PRESUMPTIVE SOIL BEARING VALUES**

Type of Soil	PSF
1. Wet soft clay; very loose silt; silty clay.....	Verified method s. ILHR 53.21 (1)
2. Loose fine sand; medium clay; loose sandy clay soils.....	2,000
3. Stiff clay; firm inorganic silt.....	3,000
4. Medium (firm) sand; loose sandy gravel; firm sandy clay soils; hard dry clay.....	4,000
5. Dense sand and gravel; very compact mixture of clay, sand and gravel.....	6,000
6. Rock.....	12,000

(b) The presumed soil bearing values shall be confirmed by exploring the type of soil to a depth of at least 5 feet below the footings during or before construction. The designer shall submit a report of confirmation to the department upon request.

(c) Where the bearing materials directly under a foundation overlie a stratum having smaller allowable bearing values, such smaller values shall not be exceeded at the level of such stratum.

History: Cr. Register, July, 1974, No. 223, eff. 1-1-75; am. (2) (b), Register, December, 1976, No. 252, eff. 1-1-77.

ILHR 53.22 Unprepared fill material, organic material. No foundation of buildings or structures shall be placed upon unprepared fill material, organic soil, alluvial soil or mud unless evidence has been presented to the department showing that the proposed load will be adequately supported. This evidence shall be in the form of a written report and shall be based on soil analyses, load tests or other acceptable criteria.

Note: The decomposition of organic material in landfill sites established for the disposal of organic wastes may produce odorous, toxic and explosive concentrations of gas which may

seep into buildings through storm sewers and similar underground utilities unless provisions are taken to release the gases to the atmosphere.

History: Cr. Register, July, 1974, No. 223, eff. 1-1-75.

ILHR 53.23 Frost penetration. (1) **DEPTH.** Footings and foundations shall be placed below the frost penetration level, but in no case less than 42 inches below adjacent ground. Such footings shall not be placed over frozen material.

(2) **FLOATING SLABS AND GRADE BEAMS.** The edges of floating slabs and grade beams need not be installed below the minimum frost penetration provided adequate measures have been taken to prevent frost forces from damaging the structure.

(3) **WALKS, STOOPS AND RAMPS ADJACENT TO REQUIRED EXITS.** The edges of walks, stoops or ramps or the footing and foundation of walks, stoops or ramps need not be installed below the minimum frost penetration line provided adequate measures have been taken to prevent frost forces from damaging the structure or affecting the structure in such a manner as to obstruct the exit.

Note: Also see s. ILHR 52.21—location and maintenance of exits.

History: Cr. Register, July, 1974, No. 223, eff. 1-1-75; r. and recr., Register, January, 1980, No. 289, eff. 2-1-80.

ILHR 53.24 Piling. (1) **GENERAL REQUIREMENT.** Pile foundations shall be designed and installed to adequately transfer the structure loads to underlying or adjacent soil bearing strata.

(2) **INSTALLATION.** Piles shall be handled and installed to the required penetration by methods which leave their strength unimpaired and that develop and retain the required load bearing capacity. Any damaged pile shall be satisfactorily repaired or the pile shall be rejected.

(3) **ALLOWABLE LOADS BASED ON SOIL CONDITIONS.** (a) *By driving formula.* For individual pile design loads not exceeding 40 tons per pile, the safe working load may be determined by a recognized formula or by the following formula:

$$P = \frac{2WH}{S+1} \text{ for drop hammer}$$

$$P = \frac{2E}{S+0.1} \text{ for double-acting hammer}$$

in which:

P = safe load (lbs.)

W = weight of striking part of hammer (lbs.)

H = fall of striking part of hammer (ft.)

E = manufacturer's rated energy (ft. — lbs.)

S = average penetration of pile under last 6 blows (inches/blow)

(b) *Substantiation of higher allowable loads.* Allowable loads greater than 40 tons will be permitted when substantiating data justifying such higher loads is submitted to the department by a foundation designer knowledgeable in the field of soil mechanics and pile foundations and familiar with the locale of the proposed project. Substantiating data such

as test borings, laboratory test results, soil profiles, and pile load tests may be required by the department. The load test shall be in accordance with the procedure outlined in ASTM D-1143 [ILHR 51.25 (45)].

(c) *Group pile action.* When friction piles are placed in groups, consideration shall be given to the reduction of load per pile.

(d) *Piles in subsiding areas.* Where piles are driven through subsiding fills or other subsiding strata and derive support from underlying firmer material, consideration shall be given to the downward frictional forces which may be imposed on the piles by the subsiding upper strata.

(e) *Lateral support.* Water, air and fluid soils shall not be considered as offering lateral support to piles. In any other type of material the piles may be designed as a short column. Positive permanent lateral support shall be provided at or near the top of all piles.

(4) ALLOWABLE LOADS BASED ON PILE MATERIAL STRENGTH. (a) The compressive stress in any cross-section of a pile shall not exceed the normal allowable compressive stress of the material used for the pile, except as given in sub. (5). The piles may be designed as short columns except as stated in sub. (3) (e).

(b) *End-bearing piles.* For end-bearing piles more than 40 feet in length, it may be assumed that 75% of the load is carried by the tip, except for piles installed in a material referred to in s. ILHR 53.22.

(c) *Friction piles.* For friction piles, the full load shall be computed at the cross section located at two-thirds of the embedded length of the pile measured up from the tip.

(5) TYPE OF PILES. (a) *Timber piles.* Timber piles shall conform to National Design Specifications, Part X [s. ILHR 51.27 (8)]. In addition, the tops of treated piles, at cutoff, shall be given 3 coats of hot creosote, followed by a coat of coal-tar pitch; and the cutoff shall be encased not less than 4 inches in concrete footing of the foundation.

(b) *Precast concrete piles.* Precast concrete piles shall be cast in one piece and shall attain a compressive strength of not less than 3,000 psi prior to driving. There shall be a minimum concrete covering of 2 inches over all reinforcing bars. Precast concrete piles shall be designed to resist stresses induced by handling, driving and super-imposed loads.

(c) *Cast-in-place concrete piles.* All concrete for cast-in-place piles shall develop a compressive strength of not less than 3,000 psi. Reinforcement shall have a concrete cover of one inch in cased piles and 2 inches in uncased piles.

1. *Uncased piles.* Cast-in-place piles in contact with earth shall be limited in length to 30 times the average diameter of the pile. The allowable compressive stress in concrete shall not exceed 0.33 f'c. The concrete shall be deposited in a shaft free of foreign matter in a continuous operation so as to insure a full sized pile without voids or segregation.

2. *Metal formed piles.* Cast-in-place piles in contact with a steel shell or casing shall have a minimum tip diameter of 8 inches and a minimum average diameter of 10 inches. The shell and casing shall be sufficiently strong to resist collapse and sufficiently watertight to exclude water and foreign material during the placing of concrete. The shell or casing cannot be considered as a load carrying part of the pile. The allowable com-

pressive stress in concrete shall be as stated for uncased piles, but it may be increased to a maximum value of 0.40 f'c if the following conditions are satisfied:

- a. The thickness of casing is not less than 0.0747 inches (14 ga AISI).
- b. The casing is seamless or is provided with seams of strength equal to that of the casing.
- c. The pile diameter is not greater than 18 inches.

(d) *Concrete-filled pipe and tapered tubular piles.* Concrete-filled pipe and tapered tubular piles may be driven open-ended or closed-ended. Pipe or tapered tube piles driven with closed ends shall be treated as a cast-in place concrete pile with metal casing and shall be governed by the same regulations applicable thereto with suitable load-bearing allowance made for the metal casing. When driven open-ended to rock, no concrete shall be deposited until the pipe is cleaned free of all soil or loose rock chips and satisfactory proof furnished of the condition of the rock. The allowable stress in steel is .35 Fy but shall not exceed 12,600 psi. The minimum wall thickness of all load-bearing pipe, tube and shells shall be 1/10 inch. When the soil surrounding the pile contains destructive chemical elements, the pile shall be provided with an approved protective jacket or coating which will not be rendered ineffective by driving.

(e) *Structural steel piles.* No section shall have a nominal thickness of metal less than 3/8 inch. When an H-shaped section is used, the flange projection shall not be more than 14 times the minimum thickness of metal. The steel stress shall not exceed 0.35 Fy.

History: Cr. Register, July, 1974, No. 223, eff. 1-1-75.

ILHR 53.25 Settlement. Where footings or floating slabs are placed upon clays or other materials which are subject to settlement, an analysis for such buildings shall include consideration of total and differential settlements anticipated.

History: Cr. Register, July, 1974, No. 223, eff. 1-1-75.

ILHR 53.26 Protection of adjoining property. (1) Any property owner (owner of an interest in land) making or causing an excavation to be made to a depth of 12 feet or less, below the grade, shall protect the excavation so that the soil of adjoining property will not cave in or settle, but shall not be liable for the expense of underpinning or extending the foundation of buildings on adjoining properties where the excavation is not in excess of 12 feet in depth. Before commencing the excavation the person making or causing the excavation to be made shall notify in writing the owners of adjoining buildings not less than 30 days before such excavation is to be made and that the adjoining buildings should be protected. The owners of the adjoining property shall be given access to the excavation for the purpose of protecting such adjoining buildings.

(a) *Exception.* The 30-day time limit for written notification may be waived if such waiver is signed by the owner of adjoining properties.

(2) Property owners (owners of an interest in land) making or causing an excavation to be made exceeding 12 feet in depth below the grade shall protect the excavation so that the soil of adjoining property will not cave in or settle, and shall extend the foundation of any adjoining buildings below the depth of 12 feet below grade at their own expense. The own-

er(s) of the adjoining buildings shall extend the foundations of their buildings to a depth of 12 feet below grade at their own expense as provided in the preceding paragraph.

History: Cr. Register, February, 1978, No. 266, eff. 3-1-78.

ILHR 53.27 Cut or fill slopes. (1) **PERMANENT CUT OR FILL SLOPES.** Cuts or fills adjacent to any building, structure or property line shall be so constructed or protected that they do not endanger life and/or property. Permanent cut slopes shall not be steeper than 1½ horizontal to one vertical and permanent fill slopes shall not be steeper than 2 horizontal to one vertical unless substantiating data justifying steeper slopes are submitted.

(2) **TEMPORARY CUT OR FILL SLOPES.** For temporary cuts and fills, refer to chs. Ind 6—Trench, Excavation and Tunnel Construction and Ind 35—Safety in Construction.

History: Cr. Register, July, 1974, No. 223, eff. 1-1-75.

ILHR 53.28 Pole foundations. Structures that use poles embedded in earth or embedded in concrete footings in the earth to resist axial and lateral loads shall have their depth of embedment determined as specified in this section.

(1) **CONSTRUCTION BACKFILL REQUIREMENTS.** The space around the pole shall be backfilled in accordance with one of the following methods:

(a) The hole shall be made 4 inches larger than the diameter or diagonal dimension of rectangular or square poles. It shall be backfilled with 2,000 psi concrete.

(b) The backfill shall be of thoroughly compacted clean sand.

(2) **ALLOWABLE LATERAL SOIL PRESSURE.** In the design of nonrestrained and restrained poles, unless a more exact soil analysis method is used, the allowable passive soil pressure shall be determined in accordance with Table 53-III.

TABLE 53-III
 ALLOWABLE LATERAL SOIL PRESSURE

Soil Types (see Table 53-II)	Allowable Passive Soil Pressure (p) ¹ psf per foot of depth below grade ^{2 3}
1 and 2 (not well drained)	100
2 (well drained)	150
3 (well drained)	200
4 (well drained)	300
5 and 6 (well drained)	400

¹S₁ and S₃ values shall not exceed 12 times the allowable passive soil pressure (p).

²Values may be increased 33½% for wind loads.

³Where ½-inch horizontal movement of the pole at ground surface can be tolerated, the values shown in Table 53-III may be increased 100%, provided the individual poles are spaced a minimum distance of 6 times B center to center.

(3) **DESIGN-NONRESTRAINED POLES.** The following formula shall be used in determining the depth of embedment required to resist lateral

loads where no restraint is provided at the ground surface, unless other methods are approved by the department.

$$d = \frac{A}{2} \left(1 + \sqrt{1 + \frac{4.36 h}{A}} \right)$$

where: d = depth of embedment, ft.

$$A = \frac{2.34 P}{S_1 B}$$

P = applied horizontal force on pole, lb.

S_1 = $pd/3$, see Table 53-III

Note: For first approximation of "d", the following formula may be used:

$$d = \sqrt[3]{\frac{12 h P}{B p}}$$

B = diameter of concrete casing, ft.; when noncased in concrete, diameter or diagonal dimension of square or rectangular pole, ft.

h = height above the ground, in feet, at which the force "P" is applied. If the pole has fixity at the top, such as provided by a knee brace, the force "P" acts at the inflection point. The inflection point may be assumed at $\frac{2}{3}$ of the distance from the ground to the knee brace for round poles, or $\frac{1}{2}$ of the distance from the ground to the knee brace for square poles.

p = allowable lateral passive soil pressure, psf.

Note #2: When a frame analysis is used, $h = M/P$, where M = bending moment on the pole at the ground surface.

(4) **DESIGN—RESTRAINED POLES.** Where restraint is provided at the ground surface, such as a rigid floor or pavement, the depth of embedment shall be in accordance with the following formula:

$$d = \sqrt{\frac{4.25 h P}{S_3 B}} \quad \text{where: } S_3 = pd, \text{ see Table 53-III}$$

(5) **MOISTURE.** A preservative treatment shall be applied to poles subjected to moisture.

Note: The department will accept poles treated in accordance with the standards of the American Wood Preservers Association for preservative treatments.

History: Cr. Register, July, 1974, No. 223, eff. 1-1-75; am. (2) and (3), cr. (4), Register, December, 1976, No. 252, eff. 1-1-77; renum. (2), (3) and (4) to be (3), (4) and (5), cr. (2), Register, December, 1977, No. 264, eff. 1-1-78; reprinted to correct error in (3), Register, December, 1985, No. 360.

Part III — Masonry

ILHR 53.30 General. (1) **SCOPE.** The requirements of ss. ILHR 53.30 through 53.36 herein shall apply to the design, construction and materials used in all masonry and similar work under this code.

(2) **DEFINITION.** Masonry as used herein shall be considered as any built-up construction or combination of building units or materials of clay, shale, concrete, stone, gypsum, glass, metal or other approved units.

(3) **DIMENSIONS.** Dimensions specified herein are nominal unless otherwise stated. The actual dimensions may vary from the nominal by the thickness of a mortar joint, but not more than one-half inch.

History: Cr. Register, July, 1974, No. 223, eff. 1-1-75.

ILHR 53.31 Materials. (1) **GENERAL REQUIREMENTS.** Components used in the construction of masonry shall be as required in ss. ILHR 53.311 through 53.316.

(2) **LABELING.** All packaged materials shall be clearly identified by name (portland cement, masonry cement, lime, gypsum, etc.) and applicable standards which are met.

History: Cr. Register, July, 1974, No. 223, eff. 1-1-75.

ILHR 53.311 Masonry units. (1) **GENERAL.** (a) *Solid and hollow units.* A solid masonry unit is a unit whose net cross-sectional area in every plane parallel to the bearing surface is 75% or more of its gross cross-sectional area measured in the same plane. A hollow masonry unit has a net cross-sectional area less than 75% of its gross cross-sectional area.

(b) *Quality.* All masonry units shall be free from cracks, laminations and other defects or deficiencies, including admixtures and coatings, which may interfere with proper laying of the unit or impair the strength or permanence of the structure.

(c) *Used masonry units.* Masonry units may be reused when clean, whole and conforming to requirements for new masonry units.

(d) *Marking requirements.* Masonry units shall be of distinctive design or appearance, or marked so that the manufacturer is identified, as required by the department.

(e) *Surface condition at time of use.* Every masonry unit shall have all surfaces, to which mortar or grout is to be applied, capable of developing the required strength and bond. Coating or facings permitted and applied to masonry unit surfaces prior to their installation shall not supersede this requirement.

(f) *Positioning in structure.* Hollow masonry units shall be laid only in positions as tested for compliance.

(2) **CLAY AND SHALE UNITS.** Clay and shale units shall be made of burned clay or shale or mixtures thereof with or without admixtures.

(a) *Solid units (brick).* Units shall conform to grade SW requirements of ASTM C-62 [s. ILHR 51.25 (19)].

(b) *Hollow units (tile and hollow brick).* 1. **Load-bearing units.** Units for use in load-bearing and exterior walls shall conform to grade LBX requirements of ASTM C-34 [s. ILHR 51.25 (11)], or grade SW requirements of ASTM C-652 [s. ILHR 51.25 (41)].

2. **Nonload-bearing units.** Units for use in nonload-bearing partitions shall be specially marked and shall conform to the requirements of ASTM C-56 [s. ILHR 51.25 (17)]. Such units may also be used for non-structural purposes in concrete floor construction.

3. Units for floor construction. Units for structural use in floor construction shall conform to grade FT 1 requirements of ASTM C-57 [s. ILHR 51.25 (18)].

(3) **CONCRETE UNITS.** Concrete units shall be made with portland cement, water and suitable mineral aggregates, with or without admixtures.

(a) *Solid units.* 1. Small units (brick). Units shall conform to grade N requirements of ASTM C-55 [s. ILHR 51.25 (16)].

2. Large units (solid block). Units shall conform to grade N requirements of ASTM C-145 [s. ILHR 51.25 (30)].

(b) *Hollow units (blocks).* Units shall conform to grade N requirements of ASTM C-90 [s. ILHR 51.25 (21)].

(4) **NATURAL STONE.** All natural building stone for use in masonry shall be sound and free from loose or friable inclusions, and shall meet the strength and fire resistance requirements for the proposed use. Where the cleavage plane of stone units is pronounced, the stone shall be laid only on its natural bed. Stone exposed to soil, weather or frost action shall be such that the strength and structure of the stone will not be affected when so exposed.

(5) **CAST STONE.** Units covered under this category are homogeneous or faced, dry cast concrete products other than conventional concrete masonry units (brick or block), but of similar size.

(a) *Composition.* Units shall be made with portland cement, water and suitable mineral aggregates, with or without admixtures, and reinforced if required.

(b) *Standards.* Units shall have a minimum compressive strength of 6500 psi and a maximum water absorption of 6% when tested as 2 x 2 inch cylinders or cubes.

(6) **ARCHITECTURAL PRECAST CONCRETE.** Units covered under this category are homogeneous or faced, wet cast nonload-bearing concrete products. Load-bearing precast concrete units shall conform to the requirements of s. ILHR 53.40.

(a) *Composition.* Units shall be made with portland cement, water and suitable aggregates, with or without admixtures, and reinforced as required.

(b) *Standards.* Units shall conform to the requirements of Table 53-IV.

TABLE 53-IV
ARCHITECTURAL PRECAST CONCRETE PHYSICAL REQUIREMENTS

Use	Compressive Strength†		Water Absorption Maximum (%)	Purposefully Entrained Air Minimum (%)
	Avg. of 3	Individual		
Exposed to freeze-thaw cycles (exterior)	4,500	3,800	8	3
All others (interior)	3,500	3,000	10	—

† Compressive strength shall be determined by procedures outlined in ASTM C-39 [s. ILHR 51.25 (12)] or C-42 [s. ILHR 51.25 (13)].

(7) **GYPSUM UNITS.** Units shall conform to the requirements of ASTM C-52 [s. ILHR 51.25 (15)]. Gypsum units shall not be used in exterior or load-bearing walls or locations exposed to frequent or continuous wetting.

(8) **MISCELLANEOUS UNITS.** See s. ILHR 50.19 for all other potential masonry units.

History: Cr. Register, July, 1974, No. 223, eff. 1-1-75; am. (8), Register, December, 1978, No. 276, eff. 1-1-79.

ILHR 53.312 Mortar. (1) **GENERAL.** Mortar as used herein shall be considered as a mixture containing cementitious materials used to permanently bond masonry or other structural elements.

(2) **MORTAR FOR UNIT MASONRY.** (a) *Composition.* Conventional mortar shall be composed of cementitious materials, fine aggregates and water. Suitable admixtures are allowed.

(b) *Standards.* All materials used as ingredients in mortar when delivered to the mixer shall conform to the requirements outlined below:

1. Cementitious materials. See s. ILHR 53.314.

2. Aggregates. Aggregates shall conform to the following requirements and to the requirements of ASTM C-144 [s. ILHR 51.25 (29)].

a. Aggregates shall be graded within the limits of Table 53-V.

TABLE 53-V
 MASONRY SAND GRADATION REQUIREMENTS

Sieve Size	Percentage Passing	
	Natural Sand	Manufactured Sand
No. 4	100	100
No. 8	95 to 100	95 to 100
No. 16	70 to 100	70 to 100
No. 30	40 to 75	40 to 75
No. 50	10 to 35	20 to 40
No. 100	2 to 15	10 to 25
No. 200	—	0 to 10

b. The aggregate shall have not more than 50% retained between any 2 consecutive sieves of those listed in Table 53-V, nor more than 25% between the No. 50 and No. 100 sieves.

c. If the fineness modulus varies by more than 0.20 from the value assumed in selecting proportions for the mortar, suitable adjustments shall be made in proportions to compensate for the change in grading.

3. Water. See s. ILHR 53.315.

4. Admixtures. Where metal ties, anchors or reinforcement are imbedded in masonry, chloride, nitrate and sulphate base salts or materials containing same shall not be used in masonry construction.

(c) *Requirements.* Mortar for masonry shall conform to the property requirements of Table 53-VI and to the requirements of ASTM C-270 [s. ILHR 51.25 (34)] unless otherwise noted in this section. If approved laboratory testing is not conducted to indicate compliance with Table 53-VI, the mortar mix shall be restricted to the provisions of Table 53-VII.

TABLE 53-VI
MORTAR PROPERTY REQUIREMENTS

Mortar Type	Compressive Strength† Min. (psi)	Water Retention Min. (%)	Air Content Max. (%)
M.....	2,500	75	18
S.....	1,800	75	18
N.....	750	75	18
O.....	350	75	18

† See s. ILHR 53.35 (3).

TABLE 53-VII
MORTAR PROPORTION RESTRICTIONS

Mortar Type	Cementitious Materials (Proportions by Volume)			Aggregate (Measured in a damp loose condition)
	Portland Cement	Masonry Cement	Lime	
Lime Cement Mortar				
M.....	1	—	¼	Not less than 2¼ and not more than 3 times the sum of the separate volumes of cementitious materials.
S.....	1	—	over ¼ to ½	
N.....	1	—	over ½ to 1¼	
O.....	1	—	over 1¼ to 2½	
Masonry Cement Mortar				
M.....	1	1	—	
S.....	½	1	—	
N.....	—	1	—	
O.....	—	1	—	

(3) **GYPSUM MORTAR.** (a) *Standards.* Gypsum mortar shall be composed of one part of unfibered calcined neat gypsum to not more than 3 parts sand by weight, with sufficient water added for workability.

(b) *Use restrictions.* Gypsum mortar shall be used only with gypsum tile and block units or as fireproofing.

(4) **MISCELLANEOUS MORTARS.** (a) *High bond mortars.* See s. ILHR 50.19 for all such mortars, glues and special additives.

(b) *Special use mortars.* See Table 53-VIII.

(5) **BOND.** It is required that sufficient bond be developed to hold the masonry assemblage together and let it act as a single unit.

Note: Initial rate of absorption of masonry units and quantity of entrained air in mortar are factors affecting bond strength.

(6) **MORTAR USE.** Masonry shall be laid in mortar of the types listed in Table 53-VIII.

TABLE 53-VIII
 MORTAR USE REQUIREMENTS

Kind of Masonry	Types of Mortar Permitted
Load-bearing or nonload-bearing masonry in contact with earth	M or S
All other load-bearing masonry	M, S or N
Nonload-bearing masonry in exterior and exposed locations where a high degree of resistance to frost action is desired	M, S or N
All other nonload-bearing walls and partitions	M, S, N or O
Fireproofing	M, S, N, O or gypsum
Special masonry:	
Gypsum partition tile or block	Gypsum
Firebrick or tile	Refractory air setting
Stack or chimney walls	Composed of portland cement, hydrated lime putty and aggregate

History: Cr. Register, July, 1974, No. 223, eff. 1-1-75; am. (4) (a), Register, December, 1978, No. 276, eff. 1-1-79.

ILHR 53.313 Masonry grout. Masonry grout for non-engineered masonry shall be type M, S or N mortar, as used in the construction, to which water is added to produce a consistency for pouring without segregation.

Note: Masonry grout for reinforced masonry shall conform to the requirements of ASTM C-476 [s. ILHR 51.25 (40)].

History: Cr. Register, July, 1974, No. 223, eff. 1-1-75.

ILHR 53.314 Cementitious materials. (1) **PORTLAND CEMENT.** Portland cement shall conform to the requirements of ASTM C-150 [s. ILHR 51.25 (31)].

(2) **MASONRY CEMENT.** Masonry cement shall conform to the requirements of ASTM C-91 [s. ILHR 51.25 (22)].

(3) **HYDRATED LIME.** Hydrated lime shall conform to Type S requirements of ASTM C-207 [s. ILHR 51.25 (33)].

(4) **GYPSUM.** Gypsum shall conform to the requirements of ASTM C-22 [s. ILHR 51.25 (9)].

History: Cr. Register, July, 1974, No. 223, eff. 1-1-75.

ILHR 53.315 Water. Water shall be clean and free from injurious amounts of oil, acid, alkali, salt, organic matter and other deleterious substances.

History: Cr. Register, July, 1974, No. 223, eff. 1-1-75.

ILHR 53.316 Reinforcing, ties and anchors. (1) **REINFORCING BARS.** Reinforcing bars shall conform to the requirements of ASTM A-165 [s. ILHR 51.25 (6)], A-616 [s. ILHR 51.25 (7)], and A-617 [s. ILHR 51.25 (8)].

(2) **CONTINUOUS JOINT REINFORCEMENT.** (a) *Material.* Ties shall be fabricated from the equivalent of cold drawn wire conforming to the requirements of ASTM A-82 [s. ILHR 51.25 (3)].

(b) *Coating.* Ties in exterior walls and potentially wet areas shall have noncorrodible cross wires for the intended use. Conformance with Class 3 requirements of ASTM A-116 [s. ILHR 51.25 (4)] is acceptable.

(c) *Assembly.* Ties shall consist of the equivalent of at least 2 No. 9 steel wire gage longitudinal wires or rods with No. 9 steel wire gage cross wires or rods spaced not over 16 inches apart along each longitudinal wire or rod electrically flush or butt welded to tie the outside wires or rods together and provide mechanical bond.

(d) *Limitations.* Ties shall be of such dimensions that they provide the following:

1. Overlap of at least 6 inches at splices.
2. Engagement of both adjacent wythes; out-to-out spacing of side rods to be approximately 2 inches less than the total wall thickness.
3. Minimum actual cover over all but the cross wires or rods of 5/8 inch clear from all masonry unit faces and their joint surfaces.

(3) **INDIVIDUAL TIES AND ANCHORS.** (a) *Material.* Ties and anchors shall be fabricated from steel, brass, bronze or other approved material. See s. ILHR 53.322 (5) (c) 1.b.

(b) *Coating.* Ties and anchors for use in exterior walls and potentially wet areas shall be noncorrodible for the intended use. Zinc coating (hot dip) conforming to the requirements of ASTM A-153 [s. ILHR 51.25 (5)] is acceptable.

(c) *Limitations.* Ties and anchors shall be of such a dimension as to engage masonry units a minimum of 2 inches on each wythe in which the tie is placed and retain a minimum actual cover of 5/8-inch clear from all exposed masonry faces and joints.

History: Cr. Register, July, 1974, No. 223, eff. 1-1-75.

ILHR 53.32 Design. (1) **GENERAL REQUIREMENTS.** Design of plain (non-reinforced) masonry shall be based either on the empirical method and limitations of s. ILHR 53.322 or on a detailed engineering analysis according to the provisions of s. ILHR 53.323. Design of reinforced masonry shall be based on the provisions of s. ILHR 53.323.

(2) **PRACTICE.** All masonry shall be designed with adequate strength and proportions to support all intended superimposed loads, resist all vertical or horizontal loads as required by this code, and comply with the fire-resistive construction requirements set forth in s. ILHR 51.04.

History: Cr. Register, July, 1974, No. 223, eff. 1-1-75.

ILHR 53.321 Types of masonry. (1) **VENEER, FURRING AND TRIM.** Veneer, furring and trim comprise a facing of weather-resistant non-combustible materials securely attached to a backing, but not so bonded as to exert common action under load. See s. ILHR 53.36 for requirements.

(2) **PANEL WALL.** A panel wall is composed of weather resisting noncombustible large masonry units, or small masonry units prefabricated into larger assemblages, securely anchored to the framing of the structure.

Register, August, 1985, No. 356

(3) **SINGLE WYTHE WALL.** A single wythe wall is one masonry unit in thickness and is built of conventional size masonry units.

(4) **MULTI-WYTHE WALL.** A multi-wythe wall is composed of 2 or more wythes of conventional size masonry units of the same or different materials all tied or bonded together.

(a) *Grouted wall.* A grouted wall is a multi-wythe wall with all spaces between wythes solidly filled with masonry grout, as defined in s. ILHR 53.313.

(b) *Slushed or parged wall.* A slushed or parged wall is a multi-wythe wall with all spaces between wythes nominally filled with mortar.

(c) *Hollow wall (includes conventional cavity wall).* A hollow wall is a multi-wythe wall with an air space maintained between wythes. A water-repellent or water-resistant insulation may be placed between wythes. The description of a hollow wall is determined by its nominal out-to-out dimension.

(5) **SPECIAL WALLS** (a) *Stack or chimney walls.* See s. ILHR 64.46 and Table 53-VIII for general requirements.

(b) *Special use walls.* See s. ILHR 53.34 for special requirements.

History: Cr. Register, July, 1974, No. 223, eff. 1-1-75.

ILHR 53.322 Empirical method of design. (1) **STRESSES.** (a) *General.* 1. In determining the stresses in masonry, the effects of all loads and conditions of loading and the influence of all forces affecting the design and strength of the several parts shall be taken into account.

2. When the effects of eccentricity of vertical loads, including loads produced by the deflection of floor and roof units, are likely to cause tensile stresses in the masonry, the masonry shall be designed in accordance with the requirements of s. ILHR 53.323.

(b) *Allowable stresses.* 1. Compressive stresses. The compressive stresses in masonry shall not exceed the values given in Table 53-IX.

2. Bearing stresses. See s. ILHR 53.34 (3) (b).

3. Composite masonry. In composite masonry with different kinds or grades of units or mortars, the maximum stress shall not exceed the allowable stress for the weakest combination of units and mortar of which the masonry is composed.

TABLE 53-IX
ALLOWABLE COMPRESSIVE STRESSES IN UNIT MASONRY¹

Type of Masonry	Type of Masonry Units	Average Ultimate Compressive Strength of Masonry Unit ² (psi)	Allowable Compressive Stresses on Gross Cross-Sectional Area ³ (psi)			
			Type M Mortar and Grout	Type S Mortar and Grout	Type N Mortar and Grout	Type O Mortar and Grout ⁴
Single wythe and grouted multi-wythe masonry	Rubble stone		140	120	100	80
	Ashlar granite		300	720	640	500
	Ashlar limestone and marble		500	450	400	325
	Ashlar sandstone and cast stone		400	360	320	250
	Solid units except concrete block	10,000 and over	450	400	350	250
		8,000 to 10,000	400	350	300	200
		6,000 to 8,000	300	275	250	175
		4,000 to 6,000	250	225	200	150
		2,500 to 4,000	175	160	140	100
		Solid concrete block	1,800 and over	175	160	140
	Hollow load-bearing units	1,000 and over	90	80	75	60
Slushed or parged multi-wythe masonry	All allowable compressive stress values to 20% less than those for equivalent types of single-wythe and grouted multi-wythe masonry.					
Hollow multi-wythe masonry	Solid units except concrete block	2,500 and over	140	130	110	80
	Solid concrete block	1,800 and over	140	130	110	80
	Hollow load-bearing units	1,000 and over	70	60	55	40

¹Where a type of masonry unit, mortar or grout is not provided for in Table 53-IX, it will be the practice of the department to allow a maximum compressive stress in the masonry which is no more than 15% of the ultimate compressive strength of a masonry assemblage as determined by an approved test.

²No individual masonry unit shall have a compressive strength less than 80% of the average ultimate compressive strength.

³Stresses shall be calculated on actual dimensions rather than nominal dimensions, with consideration for reductions such as raked joints and cavities.

⁴Type O mortar is permitted only in certain nonload-bearing masonry. See Table 53-VIII.

4. Stone flexural members. The maximum allowable flexural stress for natural stone shall be $1/6$ of its modulus of rupture.

5. Bolts and anchors. See s. ILHR 53.34 (5).

(2) **THICKNESS AND HEIGHT.** (a) *Height of masonry.* The height of a wall is defined for purposes of limitation as the maximum vertical distance between structural members completely supporting the weight of the wall or between the upper such support and the top of the wall, whichever is greater.

(b) *Thickness of load-bearing walls.* The minimum thickness of load-bearing masonry walls shall be at least 12 inches for the upper 36 feet of their height, and shall be increased 4 inches for the lower 36 feet or fraction thereof. Where a masonry load-bearing wall is made up of 2 or more wythes, the thickness of the wall shall not include any wythe less than 4 inches thick.

(bm) *Exceptions to thickness of load-bearing walls* [s. ILHR 53.322 (2) (b)]. 1. Stiffened walls. Where single wythe or grouted multi-wythe masonry load-bearing walls composed of units of the same material are laterally supported at distances not greater than 12 feet apart by masonry crosswalls or by reinforced concrete floors, they may be of 12-inch thickness for the whole 72 feet.

2. Top-story walls. Top-story walls may be of 8-inch thickness provided that they are not over 12 feet in height and the roof construction imparts no lateral thrust to the walls.

3. One-story walls. In one-story buildings not exceeding 9 feet in height, the walls may be of 6-inch thickness provided that the roof span does not exceed 18 feet.

4. Penthouses and roof structures. Masonry walls above the main roof level, 12 feet or less in height, enclosing stairways, machinery rooms, shafts or penthouses may be of 8-inch thickness, and may be considered as neither increasing the height nor requiring any increase in the thickness of the masonry below.

5. Walls of apartment buildings. In buildings defined as places of abode not more than 3 stories in height, walls may be of 8-inch thickness when not over 36 feet in height and the roof imparts no horizontal thrust.

6. Walls below grade shall comply with the requirements of par. (e).

7. Metal tied hollow walls. Hollow walls shall not exceed 36 feet in height. The space (cavity) between wythes shall be not more than 4 inches. The backing wythe shall be at least as thick as the facing wythe. When both the facing and backing wythes have a thickness of 4 inches, the height of such hollow walls shall not exceed 24 feet.

8. Masonry bonded hollow walls. Not allowed.

Note: For definition of hollow walls, see s. ILHR 53.321 (4) (c).

9. Rubble stone walls. All rubble stone walls shall be 4 inches thicker than required in (b) above, but in no case less than 16 inches in thickness. Other exceptions above do not apply to rubble stone walls.

10. Composite walls. Walls containing clay and concrete masonry units shall not exceed 48 feet in height.

(c) *Thickness of exterior nonload-bearing walls and parapets.* Nonload-bearing exterior masonry walls may be 4 inches less in thickness than required for load-bearing walls [including the exceptions under par. (bm)], but the thickness shall not be less than 8 inches except where 6-inch walls are specifically permitted.

(cm) *Exceptions to thickness of exterior nonload-bearing walls and parapets [s. ILHR 53.322 (2) (c)].* 1. Panel walls. Panel walls shall be designed with sufficient strength and thickness and anchored to the structure so as to insure adequate support and resistance to wind or other lateral forces. Panel walls shall not be less than 2 inches in actual thickness and the maximum ratio of height to thickness shall not exceed 30.

2. Parapet walls. Parapet walls shall not exceed 3 times their thickness in clear height.

(d) *Thickness of interior nonload-bearing walls (partitions).* Nonload-bearing interior partitions shall be not less than 4 inches in thickness. Where partitions designed for lateral support at the top are not in tight contact with at least a 2-hour fire-resistive construction at the top, such partitions shall be not more than 24 times their thickness in clear height (see s. ILHR 53.322 (3) (a) 3.).

(e) *Walls below grade.* Foundation walls shall be not less than 8 inches in thickness nor less than the thickness of the wall which they support. When subject to lateral pressure, foundation walls shall have lateral support at the top of the wall as specified in sub. (6). The height of wall and the depth below grade may not exceed the values specified in Table 53-IX A.

Note: The phrase "depth below grade" is intended to mean height of unbalanced fill.

1. For purposes of Table 53-IX A, "solid masonry" means solid units or hollow units with all cells grouted.

2. a. When the wall is laterally supported by vertical elements at intervals not more than 18 times the wall thickness, in addition to support at the top of the wall, the depth below grade may be one foot more than indicated in Table 53-IX A.

b. Pilasters providing lateral support shall have a width not less than 16 inches and shall project from the face of the wall not less than 1/12 the wall height. All cells of hollow units shall be filled with grout.

3. Where the height of wall or depth below grade exceeds the values indicated in Table 53-IX A, or if the wall is not laterally supported at the top, the foundation wall shall be designed in accordance with the provisions of s. ILHR 53.323 for engineered masonry.

4. When a foundation wall contains an opening more than 4 feet in width or contains openings in more than 25% of its length, the design of the wall shall be based upon an engineering analysis.

TABLE 53-IX A
 MAXIMUM HEIGHT OF WALL AND DEPTH BELOW GRADE FOR
 MASONRY FOUNDATION WALLS ^{1, 2}

Foundation Wall Construction Type of Unit and Nominal Thickness (Inches)	Maximum Wall Height ³ (Feet)	Maximum Depth Below Grade ⁴ (Feet)	
		Granular Backfill with Subsurface Drainage ⁵	Clay or Silt Backfill with Subsurface Drainage ⁵
Hollow	8	7	4½
Masonry	10	8	5½
	12	8	7
Solid	8	8	5
Masonry	10	8	6
	12	8	7

¹Where lateral support is provided by vertical elements, see s. ILHR 53.322 (2) (e) 2.

²The depth below grade and height of wall may exceed the values indicated if the design is based upon an engineering analysis.

³Clear height between floors providing lateral support.

⁴The depth below grade is determined by the height of finished grade above the basement floor or inside grade. Where exterior grade adjacent to the foundation wall is surcharged within a distance equal to the maximum depth permitted, the depth of wall shall be reduced accordingly.

⁵Walls shall be provided with subsurface drainage.

(3) LATERAL SUPPORT. (a) *Requirements.* All masonry shall be laterally supported in conformance with the following:

1. Exterior walls. Exterior masonry walls, whether they be load-bearing or nonload-bearing, shall be laterally supported either horizontally or vertically at intervals not exceeding those indicated in Table 53-X.

TABLE 53-X
 MAXIMUM RATIO OF LATERALLY UNSUPPORTED HEIGHT OR
 LENGTH TO THICKNESS FOR ALL EXTERIOR WALLS

Type of Masonry	Mortar Type			
	M	S	N	O
Single wythe walls of solid units or grouted walls of solid units	22	22	20	18
Slushed or parged walls of solid units	20	20	18	16
Hollow walls† or walls containing hollow units	18	18	16	12

†In computing the ratio for hollow walls, the value for thickness shall be the sum of the nominal thickness of the inner and outer wythes.

2. Load-bearing interior walls. Load-bearing interior walls shall have lateral supports at either vertical or horizontal intervals not exceeding 24 times the wall thickness for solid masonry units and 20 times the wall thickness for hollow masonry units.

3. Nonload-bearing interior walls (partitions). Nonload-bearing partitions shall have lateral supports at either vertical or horizontal intervals not exceeding 30 times the thickness of the wall.

4. Special Masonry Walls. a. The height of an exterior free standing masonry wall having no lateral support at the top or at the ends may not exceed 4 times the thickness of the wall.

Note: See s. ILHR 53.322 (2) (cm) 2. for parapet walls.

b. The height of a free standing interior wall may not exceed 9 times the thickness of the wall.

(b) *Methods of lateral support.* 1. General. Lateral support shall be provided by cross walls, pilasters or vertical structural members of sufficient strength to provide the required support when the limiting distance is measured horizontally; and/or by floors, roofs or horizontal structural elements which are of sufficient strength to provide the required support when the limiting distance is measured vertically. Provisions shall be made to transfer all lateral forces to the foundation.

2. Limitations. When horizontal structural elements are depended upon for lateral support, lateral support by vertical elements shall also be provided at intervals of not more than 72 times the wall thickness.

(c) *Pilasters.* A pilaster is a reinforced or nonreinforced masonry section which is thicker than and integrally bonded or mechanically keyed to the adjoining wall by alternate course bonding of masonry or by the use of pilaster blocks. A mechanically keyed control joint will be permitted on only one side of a pilaster which is used to provide lateral support. The projecting portion of the pilaster shall be bonded to the wall portion of the pilaster by lapping at least 50% of the units at the intersection or using special pilaster units.

1. All pilasters relied upon to provide lateral support shall not be less than 4 inches thicker than the wall supported nor less than 1/12 times the pilaster height. The width of pilasters shall be not less than 16 inches.

2. Where a pilaster is needed to carry a concentrated load from a flexural element, the least dimension shall be not less than 1/40 of the span of such an element and the height of the pilaster shall not exceed 12 times the least dimension of the pilaster. All voids, within and between masonry units, shall be fully grouted.

Note: The intent of this rule is to permit the empirical method of design for masonry pilasters carrying concentrated loads provided the pilaster details eliminate the eccentricity and provided the actual stresses are less than or equal to the allowable stresses. Pilasters may also be designed through engineering analysis in accordance with s. ILHR 53.323.

(d) *Piers.* A pier is an isolated column of masonry. A load-bearing wall not bonded at the sides into associated masonry shall be considered a pier when its horizontal dimension measured at right angles to the thickness does not exceed 4 times its thickness.

1. All piers shall have lateral supports so that the vertical distance between such supports does not exceed 10 times their least dimension for single wythe or grouted masonry walls of solid masonry units, 8 times their least dimension for slushed or parged masonry walls of solid masonry units, and 6 times their least dimension for other masonry.

2. The least dimension of piers carrying flexural members shall be not less than 1/30 of the span of the flexural members.

3. Piers shall be laid in running bond unless reinforced as required for stack bond walls.

TABLE 53-IX A
 MAXIMUM HEIGHT OF WALL AND DEPTH BELOW GRADE FOR
 MASONRY FOUNDATION WALLS ^{1, 2}

Foundation Wall Construction Type of Unit and Nominal Thickness (Inches)	Maximum Wall Height ³ (Feet)	Maximum Depth Below Grade ⁴ (Feet)		
		Granular Backfill with Subsurface Drainage ⁵	Clay or Silt Backfill with Subsurface Drainage ⁵	
Hollow	8	7	5	4½
Masonry	10	8	6	5½
	12	8	7	7
Solid	8	8	5½	5
Masonry	10	8	6½	6
	12	8	7	7

¹Where lateral support is provided by vertical elements, see s. ILHR 53.322 (2) (e) 2.

²The depth below grade and height of wall may exceed the values indicated if the design is based upon an engineering analysis.

³Clear height between floors providing lateral support.

⁴The depth below grade is determined by the height of finished grade above the basement floor or inside grade. Where exterior grade adjacent to the foundation wall is surcharged within a distance equal to the maximum depth permitted, the depth of wall shall be reduced accordingly.

⁵Walls shall be provided with subsurface drainage.

(3) LATERAL SUPPORT. (a) *Requirements.* All masonry shall be laterally supported in conformance with the following:

1. Exterior walls. Exterior masonry walls, whether they be load-bearing or nonload-bearing, shall be laterally supported either horizontally or vertically at intervals not exceeding those indicated in Table 53-X.

TABLE 53-X
 MAXIMUM RATIO OF LATERALLY UNSUPPORTED HEIGHT OR
 LENGTH TO THICKNESS FOR ALL EXTERIOR WALLS

Type of Masonry	Mortar Type			
	M	S	N	O
Single wythe walls of solid units or grouted walls of solid units	22	22	20	18
Slushed or parged walls of solid units	20	20	18	16
Hollow walls† or walls containing hollow units	18	18	16	12

†In computing the ratio for hollow walls, the value for thickness shall be the sum of the nominal thickness of the inner and outer wythes.

2. Load-bearing interior walls. Load-bearing interior walls shall have lateral supports at either vertical or horizontal intervals not exceeding 24 times the wall thickness for solid masonry units and 20 times the wall thickness for hollow masonry units.

3. Nonload-bearing interior walls (partitions). Nonload-bearing partitions shall have lateral supports at either vertical or horizontal intervals not exceeding 30 times the thickness of the wall.

4. Special Masonry Walls. a. The height of an exterior free standing masonry wall having no lateral support at the top or at the ends may not exceed 4 times the thickness of the wall.

Note: See s. ILHR 53.322 (2) (cm) 2. for parapet walls.

b. The height of a free standing interior wall may not exceed 9 times the thickness of the wall.

(b) *Methods of lateral support.* 1. General. Lateral support shall be provided by cross walls, pilasters or vertical structural members of sufficient strength to provide the required support when the limiting distance is measured horizontally; and/or by floors, roofs or horizontal structural elements which are of sufficient strength to provide the required support when the limiting distance is measured vertically. Provisions shall be made to transfer all lateral forces to the foundation.

2. Limitations. When horizontal structural elements are depended upon for lateral support, lateral support by vertical elements shall also be provided at intervals of not more than $\frac{7}{2}$ times the wall thickness.

(c) *Pilasters.* A pilaster is a reinforced or nonreinforced masonry section which is thicker than and integrally bonded or mechanically keyed to the adjoining wall by alternate course bonding of masonry or by the use of pilaster blocks. A mechanically keyed control joint will be permitted on only one side of a pilaster which is used to provide lateral support. The projecting portion of the pilaster shall be bonded to the wall portion of the pilaster by lapping at least 50% of the units at the intersection or using special pilaster units.

1. All pilasters relied upon to provide lateral support shall not be less than 4 inches thicker than the wall supported nor less than $\frac{1}{12}$ times the pilaster height. The width of pilasters shall be not less than 16 inches.

2. Where a pilaster is needed to carry a concentrated load from a flexural element, the least dimension shall be not less than $\frac{1}{40}$ of the span of such an element and the height of the pilaster shall not exceed 12 times the least dimension of the pilaster. All voids, within and between masonry units, shall be fully grouted.

Note: The intent of this rule is to permit the empirical method of design for masonry pilasters carrying concentrated loads provided the pilaster details eliminate the eccentricity and provided the actual stresses are less than or equal to the allowable stresses. Pilasters may also be designed through engineering analysis in accordance with s. ILHR 53.323.

(d) *Piers.* A pier is an isolated column of masonry. A load-bearing wall not bonded at the sides into associated masonry shall be considered a pier when its horizontal dimension measured at right angles to the thickness does not exceed 4 times its thickness.

1. All piers shall have lateral supports so that the vertical distance between such supports does not exceed 10 times their least dimension for single wythe or grouted masonry walls of solid masonry units, 8 times their least dimension for slushed or parged masonry walls of solid masonry units, and 6 times their least dimension for other masonry.

2. The least dimension of piers carrying flexural members shall be not less than $\frac{1}{30}$ of the span of the flexural members.

3. Piers shall be laid in running bond unless reinforced as required for stack bond walls.

(6) **ANCHORAGE.** (a) *General.* All masonry dependent upon structural elements for continuity or lateral support except as specified in s. ILHR 53.63 (3) shall be securely anchored thereto in such a manner as to resist all forces, especially wind and all lateral forces acting either inward or outward.

(b) *Load-bearing masonry.* 1. *Floor anchorage.*

a. All types of concrete floor systems which bear continuously on masonry with concrete to masonry contact may be considered to provide adequate lateral support.

b. All other structural elements intended to provide lateral support shall be securely anchored to the masonry.

2. *Roof anchorage.* Roof structures shall be securely anchored to load-bearing masonry with the equivalent of at least ½-inch diameter bolts spaced not more than 6 feet on center and embedded in the masonry according to one of the following methods:

a. A steel plate having a minimum surface area of 6 square inches securely attached to the head of each bolt and completely embedded in the masonry at least 12 inches.

b. A continuous bond beam the equivalent of not less than 8-inch lintel (bond beam) blocks with 2 continuous No. 4 bars embedded in 2,500 psi concrete fill provided at the top of the masonry. The bolts shall be embedded at least 6 inches and hook beneath the longitudinal reinforcement.

(c) *Exterior nonload-bearing masonry.* 1. Anchorage of masonry to the structural framework. Where masonry is dependent upon the structural framework for lateral support or transmission of lateral loads, the masonry shall be anchored to the framework on at least 2 opposite sides of the perimeter of the wall, with the equivalent of a one-inch wide by ½-inch thick anchor for each 18 square feet of wall surface, embedded at least 8 inches into the masonry, and spaced not more than 36 inches on center. Wedging will not be considered as an equivalent method.

2. Anchorage of panel walls suspended from the structural framework. Exterior prefabricated masonry assemblages and other elements, larger than conventional size masonry units shall be anchored to their weight supports with the equivalent of ½ inch minimum diameter stainless steel bolts or ¾ inch minimum diameter corrosion resistant plated steel bolts.

(d) *Interior nonload-bearing masonry.* Where masonry is dependent upon the structural framework for lateral support, such masonry shall be anchored with the equivalent of a flexible 3/16 inch diameter anchor for each 12 square feet of wall surface, embedded at least 4 inches into the masonry, and spaced not more than 48 inches on center. Wedging may be used to anchor the top of a masonry partition to its top horizontal support.

(7) **JOINTING.** Joints commensurate with lateral stability requirements shall be installed in all exterior masonry to allow for expected growth of clay products and shrinkage of concrete products.

(a) *Vertical jointing.* Vertical control joints shall be provided at a spacing in compliance with Table 53-XII.

TABLE 53-XII
 MAXIMUM SPACING OF EXTERIOR MASONRY CONTROL JOINTS
 BETWEEN UNRESTRAINED ENDS† (FEET)

Loading Conditions	Type of Material	Openings (Percentage of total wall area)			
		0 to 20		More than 20	
		Joint to Joint	Joint to Corner	Joint to Joint	Joint to Corner
Load-bearing	Clay units	140	70	100	50
	Concrete units	60	30	40	20
Nonload-bearing walls	Clay units	100	50	60	40
	Concrete units	50	25	30	20

†Jointing required is a minimum and is not intended to prevent minor cracking. The distances given for maximum spacing of joints are for a single wall plane. For composite walls, the maximum spacing of joints shall be governed by the masonry material type used in the exterior wythe.

Note: To accomplish the intended purpose, joints should be located at critical locations such as (but not limited to) changes in building heights, changes in framing systems, columns built into exterior walls, major wall openings and changes in materials.

(b) *Horizontal jointing.* Where supports such as shelf angles or plates are required to carry the weight of masonry above the foundation level [see ss. ILHR 53.322 (2) (a) and 53.36 (4) (b)], a pressure-relieving joint shall be provided between the structural support and any masonry which occurs below this level. The joint width shall be such as to prevent any load being transmitted from the support to any element directly below. All mortar and rigid materials shall be kept out of this joint. This type of joint shall be provided at all such supports in a concrete frame structure where clay masonry is exposed to the weather.

History: Cr. Register, July, 1974, No. 223, eff. 1-1-75; am. (5) (b) 3 and (6) (c) 1, Register, December, 1974, No. 228, eff. 1-1-75; am. (3) (c) 2 and (5) (b) 3, Register, December, 1976, No. 252, eff. 1-1-77; am. (5)(c) 1.b., Register, January, 1980, No. 289, eff. 2-1-80; am. (6) (a), Register, December, 1981, No. 312, eff. 1-1-82; r. and rec. (2) (bm) 6. and (3) (a) 4., cr. (2) (e), Register, December, 1983, No. 336, eff. 1-1-84.

ILHR 53.323 Engineered masonry. (1) **DEFINITION.** Engineered masonry means design of plain or reinforced masonry based on an engineering analysis.

(2) **REQUIREMENTS.** Calculations or other substantiating data to justify a reduction in requirements shall be submitted for all items in conflict with s. ILHR 53.322, 53.33 or 53.34.

Note: It will be the practice of the department to approve designs in conformance with the following: (1) clay and shale units—"Building Code Requirements for Engineered Brick Masonry," Structural Clay Products Institute (now known as Brick Institute of America), 1750 Old Meadow Road, McLean, Virginia 22101 (August 1969); (2) concrete units—"Specifications for the Design and Construction of Load-Bearing Concrete Masonry," National Concrete Masonry Association, P.O. Box 9185, Rosslyn Station, Arlington, Virginia 22209 (1970); (3) cast stone and architectural precast concrete units—"Design of Precast Concrete Wall Panels," Title No. 68-46, *ACI Journal*, July 1971 (also see s. ILHR 53.40); and (4) standards of accepted engineering practice, provided proposed materials are in successful similar use or proven by test to be adequate.

(3) **LIMITATIONS.** Where design by engineering analysis is based upon material of a higher grade or a superior workmanship than is generally provided in accepted practice, it must be clearly established to the satisfaction of the department by test or other evidence that such quality exists and will only be employed under special inspection or field testing.

History: Cr. Register, July, 1974, No. 223, eff. 1-1-75.
 Register, August, 1985, No. 356

ILHR 53.33 Construction. (1) **COLD WEATHER WORK.** Adequate cold weather construction and protection provisions shall be taken to prevent masonry from being damaged by freezing.

Note: It will be the practice of the department to accept conformance with "Recommended Practices for Cold Weather Masonry Construction," International Masonry Industry All-Weather Council, 1970. (Available from International Masonry Institute, 823 15th Street NW, Washington, D. C. 20005.)

(2) **WORKMANSHIP FOR LOAD-BEARING MASONRY.** (a) The maximum thickness of a mortar joint shall be $\frac{1}{2}$ inch.

(b) Except for head joints used for weep holes and ventilation, solid masonry units shall be laid so as to achieve full head and bed joints.

(c) Hollow masonry units shall be laid with full head joints and full bed joints under the full bearing areas of the face shells (and under webs where the adjacent cells are to be filled with grout).

(3) **CLEANING.** Chemical cleaning agents shall be prevented from harming the metal reinforcement of structural components.

History: Cr. Register, July, 1974, No. 223, eff. 1-1-75; r. (1) and renun., Register, December, 1974, No. 228, eff. 1-1-75.

ILHR 53.34 Miscellaneous design-construction details. (1) **SPECIAL USE WALLS.** (a) *Hollow walls.* 1. In exterior hollow walls, suitable flashing shall be installed at the bottom of the cavity so as to drain any water outward.

2. Open vertical joints or weep holes of $\frac{3}{8}$ inch minimum diameter shall be provided in the facing just above the flashing at a horizontal spacing not exceeding 3 feet.

(b) *Retaining walls.* The tops of exposed retaining walls shall be coped with noncombustible weatherproof material.

(c) *Reuse of existing walls.* Existing masonry may be used in the alteration or extension of a structure, provided that under the new conditions imposed it meets the requirements of this code or is made so by reasonable repairs.

Note #1: See s. ILHR 51.02 (12) for requirements of parapet walls.

Note #2: See s. ILHR 53.11 (4) (e) 2. for requirements for scuppers or relief openings.

(2) **CHANGES IN THICKNESS OR PLANE.** (a) *Nonvertical planes.* Details and techniques for all masonry to be installed in a nonvertical plane shall be submitted to the department for approval.

(b) *Thickness change requirements.* Where hollow walls or walls of hollow masonry units change in thickness, a course of solid masonry, concrete-filled hollow units or a continuous bearing element shall be interposed between the thicker and thinner sections.

(c) *Increase in thickness, including corbels.* The thickness of masonry shall not be increased (in the upward direction), except for corbels as follows:

1. The maximum horizontal projection of a corbel from the face of the wall from which it projects shall not exceed $\frac{1}{3}$ the thickness of the wall.

2. The maximum projection of a masonry unit shall not exceed $\frac{1}{2}$ the height of the unit nor $\frac{1}{4}$ its bed depth.

(d) *Variation in thickness (chases and recesses)*. Walls shall not be less than their required thickness between horizontal lateral supports except where permitted for chases and recesses as follows:

1. Chases or recesses shall not be made in load-bearing walls 8 inches or less in thickness. Pipes, ducts, conduits or similar noncombustible items may be installed in cores of hollow units.

2. Chases or recesses shall not be closer than 2 feet to any pilaster, buttress, cross wall, end wall or other stiffener that provides lateral support.

3. The maximum depth of any chase or recess shall not exceed $\frac{1}{4}$ the thickness of the wall.

4. The length along the wall of any chase or recess shall not exceed 4 feet.

5. The clear distance between chases and recesses or each other shall not be less than 4 times the wall thickness.

6. Any chase or recess in conflict with the previous requirements shall be considered as an opening (see s. ILHR 53.34 (3) (a) 4.).

7. No chase or recess shall reduce the thickness of material below the minimum required for fire walls, fire division, fire partitions or fire protective covering of structural members.

(e) *Protection*. In masonry exposed to the weather, pockets or crevices in which water may accumulate shall be avoided or protected to prevent damage.

(3) **BEARING**. (a) *Weight support of masonry*. 1. *General requirements*. The bearing support for all masonry shall be of noncombustible material and have lateral stability.

2. *Projections*. The projection of a wall beyond the edge of a supporting member other than masonry, such as a shelf angle or edge of a beam, shall not exceed $1\frac{1}{4}$ inches, unless at least $\frac{2}{3}$ the mass of the wythe of masonry involved is located directly over the load-carrying member.

3. *Shelf angles*. See s. ILHR 53.322 (7) (b).

4. *Openings*. The masonry above openings shall be adequately supported. The bearing length of structural elements which support the masonry above the opening shall be not less than 4 inches. The bearing stresses at these locations shall not exceed those allowed in s. ILHR 53.322 (1).

(b) *Bearing on masonry*. Bearing stresses in masonry shall not exceed those specified in Table 53-IX. Flexural members shall have bearing details that allow rotation at their supports without causing local failures.

1. *Concentrated loads*. Beams, girders, trusses, joists and other members causing concentrated loads shall bear a minimum of 3 inches in length in the direction of span upon at least one of the following:

a. Concrete beam. The equivalent of a nominally reinforced 2,500 psi concrete beam 8 inches in height.

b. Solid masonry. At least 8 inches in height of masonry composed of solid masonry units with all voids and joints completely filled with mortar.

c. Metal plate. A metal plate of sufficient thickness and size to safely distribute the load to masonry units. For piers and columns, the bearing plate shall not exceed 60% of the cross-sectional area of the pier or column and the resultant reaction of all vertical and horizontal loads shall fall within the middle third of the member.

d. Bond beam. The bond beam shall be the equivalent of not less than 8-inch lintel (bond beam) blocks with 2 No. 4 bars embedded in 2,500 psi concrete fill. The loads shall bear on the concrete fill.

2. Continuous loads. Joists, trusses and beams other than wood [for wood, see s. ILHR 53.63 (4)], spaced 4 feet or less on center and 40 feet in span, slabs or other members causing continuous loads shall be transmitted to masonry with a minimum bearing length of 3 inches upon solid masonry at least 2½ inches in height, or as indicated for concentrated loads.

3. Multi-wythe walls. Ties required for transverse bond shall be installed in the first horizontal mortar joint below the required beam, solid masonry or metal plate.

4. Stack bond walls. Concentrated loads shall be distributed into masonry laid in stack bond by a concrete beam or bond beam (as defined in subd. 1.). For masonry of solid units, 2 additional rows of a continuous tie assembly [as defined in s. ILHR 53.316 (2)] may be used instead of a concrete beam or bond beam.

5. Support of wood floor members. a. Where a wood structural member is buried in masonry for support, it shall be firecut or a self releasing device shall be used.

b. Where the end of a wood structural member is built into an exterior wall, a ½-inch air space shall be provided at the sides, top and end of such member.

(4) JOINTING. See s. ILHR 53.322 (7) for jointing.

(5) BOLTS AND ANCHORS. The allowable shear on steel bolts and anchors shall not exceed the values given in Table 53-XIII.

TABLE 53-XIII
ALLOWABLE SHEAR ON BOLTS AND ANCHORS

Bolt or Anchor Diameter (Inches)	Embedment† (Inches)	Allowable Shear (Pounds)
¼	4	270
⅜	4	410
½	4	550
⅝	4	750
¾	5	1100
⅞	6	1500
1	7	1850
1½	8	2250

†Bolts and anchors shall be solidly embedded in mortar or grout.

History: Cr. Register, July, 1974, No. 223, eff. 1-1-75; am. (1) (d), Register, December, 1974, No. 228, eff. 1-1-75; am. (3) (b) (intro.) and 1 b, Register, December, 1977, No. 264, eff. 1-1-78; am. (1), Register, December, 1981, No. 312, eff. 1-1-82.

ILHR 53.35 Tests. (1) GENERAL. All masonry materials shall meet the requirements of s. ILHR 53.31, and the department may require submittal of test data, at any time, to show conformity.

(2) **SAMPLING AND TESTING.** The selection and construction of all test specimens shall conform to standard test procedures and shall be truly representative of the materials, workmanship and details to be normally applied in practice.

(3) **STANDARDS.** The testing of all masonry shall be in accordance with Table 53-XIV.

(4) **SPECIAL TESTS. (a) Fire tests.** See s. ILHR 51.04.

(b) **Load tests.** Whenever there is reasonable doubt as to the stability or structural safety of a completed structure or part thereof, the department may require a load test on the building or portion of the structure in question.

TABLE 53-XIV
STANDARD METHODS OF SAMPLING AND TESTING

Classification	Item	ASTM Test Method Including s. ILHR 51.25 (No.)
Base Materials	Portland Cement	C 150(31)
.....	Masonry Cement.....	C 91(22)
.....	Hydrated Lime.....	C 25(10), C 50(14), C 110(25)
.....	Gypsum.....	C 471(37), C 472(38)
.....	Aggregate	C 144(29)
Mortar	Mortar	C 270†(34)
Masonry Units	Clay and Shale	C 67(20), C 112(26)
.....	Concrete.....	C 140††(28)
.....	Natural Stone.....	C 97(23), C 99(24), C 170(32), C 666(42)
.....	Cast Stone.....	C 42(13), C 97(23)
.....	Arch. Precast Concrete....	C 39(12), C 42(13), C 97(23), C 457(36)
.....	Gypsum.....	C 473(39)
Assemblies.....		E 72(46), E 149(51), E 447(54)

†Mortar in the field, tested in a laboratory, shall test at least 85% of the minimum compressive strength required, and the field mortar will serve as the final basis for mortar approval. When mortar is not proportioned according to limitations of Table 53-VII, mortar shall be periodically tested by an impartial testing laboratory. Results of such required testing shall be submitted as evidence of conformity, when requested by the department.

††Typical hollow load-bearing concrete masonry units shall be initially tested for compliance; thereafter periodic testing may be required as directed by the department. Sampling shall be done only by the department or its authorized agents. The time and place of sampling will be at the discretion of the department.

Note: A record of initial test and subsequent spot checks will be kept by the department.

History: Cr. Register, July, 1974, No. 223, eff. 1-1-75.

ILHR 53.36 Veneer, furring and trim. (1) **GENERAL.** Veneer, furring and trim as used in this section refers to a facing of weather-resistant noncombustible materials securely attached to a backing, but not so bonded as to exert common action under load.

(a) Veneer shall not be considered as part of the masonry when computing strength or required thickness.

(b) Veneer shall not be assumed as supporting any load other than its own weight.

(2) **MATERIAL REQUIREMENTS.** (a) *General.* See s. ILHR 53.31 for typical requirements of common masonry materials.

(b) *Tile and terra-cotta.* Such units shall be frost-proof and not more than 288 square inches in area.

(3) **THICKNESS.** No materials used for veneer shall have a thickness less than the values listed in Table 53-XV.

(4) **BEARING AND BACKING SUPPORTS.** (a) Bearing and backing supports shall be weather-resistant and shall provide sufficient strength and stability to adequately support the veneer.

TABLE 53-XV
 MINIMUM THICKNESS OF VENEERS

Material	Minimum Actual thickness (Inches)
Clay Brick or Tile	1%
Concrete Masonry Units	1%
Natural Stone.....	1%
Cast Stone.....	1½
Architectural Precast Concrete.....	¾
Marble Slabs	¾
Slate.....	¾
Architectural Terra-cotta	1
Ceramic Veneer—Mechanical Anchorage	1
Ceramic Veneer—Adhesion Anchorage.....	3/16
Asbestos Cement Boards.....	¾
Aluminum Clapboard Siding024
Metal—Corrosion Resistant.....	.0149
Stucco and Exterior Plaster.....	¾

(b) Masonry veneer 1½ inches or greater in thickness shall be supported by shelf angles or other equivalent weight supports. The spacing between such supports shall not exceed 18 feet vertically when the veneer is more than 30 feet above grade.

(5) **ATTACHMENT.** (a) *General.* All veneers, supports and attachments shall be capable of resisting a horizontal force equal to the wind loads specified in s. ILHR 53.12. Attachment shall be accomplished by mechanical methods or adhesion.

(b) *Attachment by mechanical methods.* All anchors shall be corrosion-resistant.

1. Veneer of conventional size masonry units (one square foot or less). Such veneer shall be securely attached to its backing by anchors the equivalent of 22 U.S. gage corrugated sheet steel $\frac{3}{8}$ inch wide with at least one such tie located in every 2 square feet of wall.

2. Veneer of large size masonry units (greater than one square foot). Such veneer shall be securely attached with anchors the equivalent of not less than $\frac{1}{4}$ inch diameter bolts in accordance with either of the following:

a. Each unit individually anchored to the supporting framework with at least 3 anchors.

b. Individual units doweled to each other at all horizontal joints and anchored to the backing at all horizontal and vertical joints so that one anchor is provided for every 6 square feet of wall surface.

3. Veneer of metal. Exterior metal veneer shall be securely attached to its backing or supporting framework with the equivalent of wire of at least No. 9 steel wire gage spaced not more than 24 inches apart both horizontally and vertically. Wider spacing where proved adequate may be used when units exceed 4 square feet in area, provided there are at least 4 proper attachments per unit.

(c) *Attachment by adhesion.* Veneer one inch or less in thickness may be cemented to a masonry or concrete wall or to exterior portland cement plaster on high rib galvanized metal lath with an adhesive, provided that the bond is sufficient to withstand a shearing stress of 50 psi after curing for 28 days. Individual units so attached shall not exceed 30 inches in any one dimension nor have more than 540 square inches of face area.

(6) **JOINTING.** Pressure-relieving joints commensurate with lateral stability requirements shall be provided both horizontally and vertically where needed to compensate for differential movement between veneer and backing or frame. See also s. ILHR 53.322(7).

(7) **GROUNDING.** Metal veneers fastened to supporting elements which are not a part of the grounded metal framing of a building shall be effectively grounded.

History: Cr. Register, July, 1974, No. 223, eff. 1-1-75.

Part IV — Concrete

ILHR 53.40 Concrete requirements. The design and construction of structures in concrete of cast-in-place or precast construction, plain, reinforced or prestressed shall conform to the rules and principles of the following standards:

ACI Std. 318 [s. ILHR 51.26 (1)], Building Code Requirements for Reinforced Concrete.

Note: The following standards and recommendations are recognized by the department as being good engineering practice: (1) "Commentary on Building Code Requirements for Reinforced Concrete," ACI Report 318; (2) "Recommended Practice for Selecting Proportions for Concrete," ACI Std. 211.1; (3) "Recommended Practice for Selecting Proportions for Structural Lightweight Concrete," ACI Std. 211.2; (4) "Recommended Practice for Hot Weather Concreting," ACI Std. 605; (5) "Recommended Practice for Cold Weather Concreting," ACI

Register, August, 1985, No. 356

Std. 306; (6) "Manual of Standard Practice for Detailing Reinforced Concrete Structures," ACI Std. 315; (7) "Recommended Practice for Evaluation of Compression Test Results of Field Concrete," ACI Std. 214; (8) "Recommended Practice for Measuring, Mixing and Placing Concrete," ACI Std. 614; (9) "Recommended Practice for Concrete Formwork," ACI Std. 347; (10) "Specification for the Design and Construction of Reinforced Concrete Chimneys," ACI Std. 505; (11) "Suggested Design of Joints and Connections in Precast Structural Concrete," ACI Report 512; (12) "Guide for Cellular Concretes Above 50 pcf, and for Aggregate Concretes Above 50 pcf with Compressive Strengths Less than 2500 psi," ACI JOURNAL, February 1975 (Copies of above standards and recommendations may be obtained from American Concrete Institute, P.O. Box 19150, Redford Station, Detroit, Michigan 48219); (13) "Recommended Practices for Welding Reinforcing Steel, Metal Inserts and Connections in Reinforced Concrete Construction," AWS Std. 12.1 (American Welding Society, 2501 NW 7th St., Miami, Florida 33125).

History: Cr. Register, July, 1974, No. 223, eff. 1-1-75; am. Register, December, 1981, No. 312, eff. 1-1-82.

ILHR 53.41 Gypsum concrete requirements. (1) **GENERAL.** The design and construction of gypsum concrete shall be in accordance with the following standards:

- (a) ASTM C 317 [s. ILHR 51.25 (35)], Standard Specifications for Gypsum Concrete.
- (b) ANSI A 59.1 [s. ILHR 51.27 (5)], Specifications for Reinforced Gypsum Concrete.

(2) **LIMITATIONS.** Gypsum concrete shall not be used where exposed directly to weather or where subject to wetting. Gypsum concrete shall be protected from freezing or coming in contact with moisture during shipment, storage, erection or pouring.

History: Cr. Register, July, 1974, No. 223, eff. 1-1-75.

ILHR 53.42 Vermiculite concrete requirements. Vermiculite concrete, when used in roof systems and slabs-on-grade, shall be in accordance with: ANSI A 122.1 [s. ILHR 51.27 (5)], "Specifications for Vermiculite Concrete Roofs and Slabs-on-Grade." Vermiculite concrete shall not be used where it can be subjected to moisture.

History: Cr. Register, July, 1974, No. 223, eff. 1-1-75.

Part V — Metals

ILHR 53.50 Structural steel requirements. The design, fabrication and erection of structural steel for buildings and structures shall conform to: AISC [s. ILHR 51.27 (2)], "Specification for Design, Fabrication and Erection of Structural Steel for Buildings," and the provisions of the accompanying commentary for this specification, with the following modifications:

(1) **FABRICATOR SPLICES.** Any shop or field connection or splice not specifically shown on the designer's drawings shall have been previously approved by the designer and a record shall be kept of this approval. This record shall be submitted to the department when requested.

(2) **LATERAL BRACING MEMBERS.** (a) Individual bracing members providing lateral restraint to columns or to compression flanges of beams and girders or to compression chords of trusses shall be proportioned to resist at least 2% of the compression force in the element braced unless a suitable analysis is made to determine the appropriate strength and stiffness of the bracing member.

(b) An analysis shall be conducted when bracing forces larger than 2% of the compression force are encountered in lateral bracing members, such as angles, channels and zee sections.

Note: These bracing forces may be encountered as a result of the lack of symmetry of the lateral bracing members.

(3) **CERTIFICATION AND IDENTIFICATION.** (a) *Certification.* All structural steel shall have a mill report or a test report made in accordance with ASTM A-6 [s. ILHR 51.25 (1)] from the steel supplier; the reports shall include the information on the minimum yield strength and chemistry of the steel furnished. Upon request by the department, the supplier or fabricator shall furnish certified mill reports, test reports, affidavits and/or other information about the steel for the specific project.

(b) *Marking of steel.* Steel used for main components in completed members or assemblies shall be marked. This marking shall be accomplished by color coding or other means of identification as to its type or grade prior to shipment from the mill. The marking shall be continued through the fabricator's plant to the construction site. Steel which conforms to ASTM A-36 [s. ILHR 51.25 (2)] designation may be fabricated without marking.

Note: The type and grading may be indicated by the ASTM specification designation or a designation correlated to the information included on the certified mill or test report.

(c) *Acceptable steel types.* Steel of structural quality shall conform to the standards specified in section 1.4.1.1 of the AISC [s. ILHR 51.27 (2)]. Steel types not listed in the above mentioned section of the AISC may be used if approved by the designer. An approval letter indicating conformance with pars. (a) and (b) shall be sent to the department.

History: Cr. Register, July, 1974, No. 223, eff. 1-1-75; am. (2), Register, December, 1983, No. 336, eff. 1-1-84.

ILHR 53.51 Cold formed steel requirements. The design of cold-formed steel for buildings and structures shall conform to the AISI [s. ILHR 51.27 (4)] "Specification for the Design of Cold-Formed Steel Structural Members," and the provisions of the accompanying commentary for this specification, with the following modifications:

- (1) **FABRICATOR SPLICES.** See s. ILHR 53.50 (1)
- (2) **LATERAL BRACING MEMBERS.** See s. ILHR 53.50 (2).
- (3) **CERTIFICATION.** See s. ILHR 53.50 (3) (a).

History: Cr. Register, July, 1974, No. 223, eff. 1-1-75.

ILHR 53.52 Steel joist requirements. The design, fabrication and erection of steel joists shall conform to the "Standard Specifications, Load Tables, and Weight Tables for Steel Joists and Joist Girders" adopted by the SJI [s. ILHR 51.27 (9)].

History: Cr. Register, July, 1974, No. 223, eff. 1-1-75; am. Register, January, 1980, No. 289, eff. 2-1-80.

ILHR 53.53 Structural welding of steel. The requirements of this section shall apply to all welds on or between materials within the scope of ss. ILHR 53.50, 53.51 and 53.52.

(1) **BASE METALS.** Steels to be welded under this code are listed in AWS D 1.1, sections 8.2 and 10.2 [s. ILHR 51.27 (6)].

Register, August, 1985, No. 356

(2) **FILLER METALS.** Filler metal requirements that are acceptable under this code are listed AWS D 1.1 section 4.1 [s. ILHR 51.27 (6)].

(3) **WELDING PROCESSES.** (a) Manual shielded metal arc, submerged arc, gas metal arc and flux cored arc welding processes conforming with the procedures established in AWS D 1.1, sections 2, 3 or 4 [s. ILHR 51.27 (6)] shall be considered as prequalified and are approved for use without performing procedure qualification tests.

(b) Electroslag and electrogas welding processes will not be considered as prequalified. They may be used provided a procedure is developed and provided it conforms to the applicable provisions of AWS D 1.1, sections 2, 3 or 4 [s. ILHR 51.27 (6)].

(4) **WELDING PROCEDURES.** (a) *Procedure specification.* All welding procedures shall be prepared as a written procedure specification. This written procedure specification shall be prepared by the manufacturer, fabricator or contractor and shall be made available or submitted to the department when requested.

(b) *Procedure qualification.* All joint welding procedures shall be previously qualified by tests as prescribed in AWS D 1.1 section 5.6 [s. ILHR 51.27 (6)], except for the prequalified procedures exempted in s. ILHR 53.53 (3) (a). The test shall be conducted under the supervision of an approved testing laboratory and the test results shall be submitted to the department for approval.

(5) **DESIGN OF WELDED CONNECTIONS AND JOINTS.** The details of all joints shall comply with the requirements of AWS D 1.1, section 2 and section 10, parts C and D [s. ILHR 51.27 (6)]. All joint forms, except those specified in AWS D 1.1, section 2 and section 10, parts C and D, shall not be used unless qualified to the satisfaction of the department.

(a) *Stud welding.* Stud welding shall be done by a procedure qualified in accordance with the requirements of AWS D 1.1, section 4, part F [s. ILHR 51.27 (6)].

(6) **OPERATOR QUALIFICATIONS.** All structural welding work shall be done by certified [as defined in s. ILHR 53.53 (7)] welders. The required qualification test shall be conducted under the supervision of an approved testing laboratory. The weld test report shall be submitted to the department for evaluation. Test specimens shall be submitted when requested by the department.

(a) The manual welders shall be tested and qualified in accordance with AWS D 1.1, section 5, part C [s. ILHR 51.27 (6)].

(b) The manual tackers shall be tested and qualified in accordance with AWS D 1.1, section 5, part E [s. ILHR 51.27 (6)].

(c) The welding machine operator shall be tested and qualified in accordance with AWS D 1.1, section 5, part D [s. ILHR 51.27 (6)].

(7) **OPERATOR CERTIFICATION.** The department will issue to the welder or welding machine operator who has successfully passed the prescribed qualification tests, a certificate bearing his name, social security number, identifying mark, the process, the procedure specification number and other pertinent information from his qualification test. This certificate will remain in effect for 3 years provided the operator is continuously engaged in welding operations without an interruption of more than 3

consecutive months. If the interruption exceeds 3 consecutive months, the certificate shall automatically become void.

(a) Each manual welder and tacker or welding machine operator shall be retested every 3 years in accordance with s. ILHR 53.53 (6).

(b) Each manual welder and tacker or welding machine operator certificate which has become void due to welding operation interruption exceeding 3 consecutive months or having exceeded the 3-year certificate time limit can be renewed only by retesting at an approved testing laboratory.

(c) The department shall issue the operator certification within 15 business days of the time the welder successfully passes the prescribed qualification test.

(8) **WELD IDENTIFICATION.** Each structurally significant member shall have its welding identified by a distinguishing mark stamped on the member by the certified welders involved.

(9) **CRITERION OF FINAL ACCEPTANCE.** All structural welding is subject to examination by approved inspectors and such inspection shall be the final criterion for conformance and acceptability for the intended use.

(10) **STRUCTURAL WELDING DONE OUTSIDE THIS STATE.** All welding shall conform with the requirements of s. ILHR 53.53 except the requirements of sub. (7). In lieu of operator certification, manufacturers and suppliers of structural steel shall, prior to commencing any welded construction, submit evidence of procedure qualification, if not prequalified, and welder certification that has been approved by an independent testing laboratory which is acceptable to the department. Manufacturers and suppliers are required to keep the welder certification current.

Note: The welder certification requirement may be submitted and kept current by having the approved testing laboratory submit a list of certified welders to the department. The submittal may be a part of the materials approval information submitted for s. ILHR 50.19 or may be submitted separately for the manufacturers not having a materials approval.

History: Cr. Register, July, 1974, No. 223, eff. 1-1-75; am. (10), Register, December, 1977, No. 264, eff. 1-1-78; am (5) and (6)(a), (b) and (c), Register, January, 1980, No. 289, eff. 2-1-80; cr. (7) (c), Register, January, 1985, No. 349, eff. 2-1-85.

ILHR 53.54 Aluminum framing requirements. The design, fabrication and erection of aluminum structural framing members shall conform to "Specifications for Aluminum Structures" [s. ILHR 51.27 (1)], published by The Aluminum Association.

History: Cr. Register, July, 1974, No. 223, eff. 1-1-75.

ILHR 53.55 Stainless steel requirements. The design, fabrication and erection of light gage stainless steel framing members shall conform to AISI [s. ILHR 51.27 (4)], "Stainless Steel Cold-Formed Structural Design Manual."

History: Cr. Register, July, 1974, No. 223, eff. 1-1-75; am. Register, January, 1980, No. 289, eff. 2-1-80.

ILHR 53.56 Steel cable requirements. The design, fabrication and erection of steel cables for buildings shall conform to AISI [s. ILHR 51.27 (4)], "Manual for Structural Applications of Steel Cables for Buildings."

History: Cr. Register, January, 1980, No. 289, eff. 2-1-80.

Register, August, 1985, No. 356

ILHR 53.57 Other metals. The design, fabrication and erection of other metals or metal alloys not specifically listed in this section shall be in accordance with the provisions of s. ILHR 50.19.

History: Cr. Register, July, 1974, No. 223, eff. 1-1-75; am. Register, December, 1976, No. 252, eff. 1-1-77; renum. from Ind 53.56 and am., Register, January, 1980, No. 289, eff. 2-1-80.

Part VI—Wood and Wood Fiber Products

ILHR 53.60 General. (1) **SCOPE.** The requirements of ss. ILHR 53.60 to 53.63, inclusive, shall apply to the materials, design, and construction procedures used in all wood and wood fiber products construction work under this code.

(2) **DEFINITION.** Wood and wood fiber products include those structural elements derived from solid wood, structural glued-laminated timber, plywood, fiberboard, hardboard and other wood-fiber-based materials.

History: Cr. Register, July 1974, No. 223, eff. 1-1-75.

ILHR 53.61 Materials and design of structural elements. (1) **SAWN LUMBER.** The material characteristics and the design provisions of load-bearing structural sawn lumber shall be in accordance with the following adopted standard and listed exceptions:

(a) "National Design Specification for Wood Construction" [s. ILHR 51.27 (8)] and its supplement.

1. Exceptions: a. Section 4.1.7. The provisions of this section shall also apply to reused lumber. Reused lumber shall be considered to have a duration of load factor of 0.90.

b. Section 4.2.2. In addition to requiring grading in conformance with ASTM D 245 [s. ILHR 51.25 (43)], lumber (including reused lumber) of species and grades not listed in the supplement to the NDS [s. ILHR 51.27 (8)] shall be identified by the grade mark of, or certificate of inspection issued by, a lumber grading or inspection bureau or agency recognized as being competent.

c. Section 2.2.5.3. The cumulative effects of short-time loads, such as snow, shall be considered in determining duration of load. For snow load, no greater duration of load factor than 1.05 shall be used.

(2) **STRUCTURAL GLUED-LAMINATED TIMBER.** Structural glued-laminated timber is an engineered, stress-rated product of a timber laminating plant comprising assemblies of specially selected and prepared wood laminations securely bonded together with adhesives. The grain of all laminations is approximately parallel longitudinally. The following standards are adopted as part of this building code for the design and production of structural glued-laminated timber, except that the modification of design stresses for duration of load shall be as specified in sub. (1) (a) 1.c.

(a) AITC 117 [s. ILHR 51.27 (3)], "Standard Specifications for Structural Glued-Laminated Timber of Softwood Species."

(b) AITC 119 [s. ILHR 51.27 (3)], "Standard Specifications for Hardwood Glued-Laminated Timber."

(3) **ROUND POLES.** Allowable unit stresses for nongraded round poles used as structural members other than piling shall be 80% of the allowable unit stresses for select structural grade beams and stringers (19% moisture content) of the appropriate species as listed in the supplement to the National Design Specification for Wood Construction [s. ILHR 51.27 (8)]. No obviously unsound load-bearing poles are to be used. Higher allowable stresses will be permitted for round poles graded in accordance with a recognized standard.

Note: ASTM designation D 3200-73 "Standard Specification and Methods for Establishing Recommended Design Stresses for Round Timber Construction Poles" is acceptable for graded round poles. ANSI Standard 05.1-1972 may be used for poles subject to transverse loads only.

(4) **PILING.** See s. ILHR 53.24.

(5) **PLYWOOD.** (a) The quality and design of all plywood used in construction of all buildings and structures shall conform to the minimum standards under this section. All plywood when used structurally, including among others, use for siding, roof and wall sheathing, subflooring, diaphragms, and built-up members, shall conform to the performance standards for its type in U.S. Product Standard PS 1 [s. ILHR 51.27 (11)] for softwood plywood/construction and industrial. Each panel or member shall be identified for grade and glue type by the trademarks of an approved testing and grading agency. In addition, all plywood when permanently exposed in outdoor applications shall be of exterior type.

Note: It will be the policy of the department to approve designs in conformance with the following: (1) "Plywood Design Specification" including Supplement No. 1 "Design of Plywood Curved Panels"; Supplement No. 2 "Design of Plywood Beams"; Supplement No. 3, "Design of Flat Plywood Stressed-Skin Panels"; and Supplement No. 4 "Design of Flat Plywood Sandwich Panels"; (2) "Plywood Diaphragm Construction"; (3) Laboratory Report 121, "Plywood Folded Plate Design and Details"; (4) Laboratory Report 93, "Load-Bearing Plywood Sandwich Panels"; and (5) "Fabrication Specifications Plywood-Lumber Components: CP-8, BB-8, SS-8, SP-61, FF-62, PW-61" (above publications available from the American Plywood Association, 1119 A Street, Tacoma, Washington 98401); (6) Design Guide HP-SG-71, "Structural Design Guide for Hardwood Plywood" (available from the Hardwood Plywood Manufacturers Association, 2310 South Walter Reed Drive, Arlington, Virginia 22206).

(b) No part of any of the above referenced standards shall supersede the general live load requirements of s. ILHR 53.11.

(6) **RECONSTITUTED WOOD BASE-FIBER AND PARTICLE PANEL MATERIALS.** Materials of this type, when used structurally, shall be approved by the department in accordance with the requirements of s. ILHR 50.12. Evaluation will be based on ASTM D 1037 [s. ILHR 51.25 (44)].

(7) **SOLID WOOD FLOOR AND ROOF SHEATHING.** Minimum thickness of nonstress rated lumber used for floor and roof sheathing shall be in accordance with Table 53-XVI.

TABLE 53-XVI
 MINIMUM NET THICKNESS OF LUMBER PLACED (INCHES)

Use	Span (Inches)	Perpendicular to Support		Diagonal to Support	
		Surfaced Dry†	Surfaced Unseasoned	Surfaced Dry†	Surfaced Unseasoned
Floors.....	24	3/4	25/32	3/4	25/32
	16	5/8	11/16	5/8	11/16
Roofs.....	24	5/8	11/16	3/4	25/32

†Maximum 19% moisture content.

(a) The above dimensions shall be the minimum dimensions for lumber with grades as specified in Table 53-XVII.

TABLE 53-XVII
 MINIMUM BOARD GRADES†

Grading Agency	Solid Floor or Roof Sheathing	Spaced Roof Sheathing
West Coast Lumber Inspection Bureau	Utility	Standard
Western Wood Products Association	4 Common or Utility	3 Common or Standard
Southern Pine Inspection Bureau	No. 3	No. 2
Redwood Inspection Service	Merchantable	Construction, common
National Lumber Grades Authority	4 Common or Utility	3 Common or Standard
Northern Hardwood and Pine Manufacturers Association	4 Common	3 Common
Northeastern Lumber Manufacturers Association	4 Common	3 Common

†The above grades are taken from grading rules approved by the American Lumber Standards Committee.

(8) **TIMBER FASTENERS.** The design and use of timber fasteners shall be in accordance with the requirements of National Design Specification for Wood Construction [s. ILHR 51.27 (8)].

(a) *Fastener identification.* Light gauge perforated metal plate connectors shall be permanently identifiable with regard to their gauge and manufacturer.

(9) **WOOD FOUNDATIONS AND WALLS BELOW GRADE.** (a) *Design.* 1. The design of wood foundations and walls below grade shall be in accordance with the following adopted standard and subd. 2: "All-Weather Wood Foundation System, Basic Requirements," Technical Report No. 7 under s. ILHR 51.27 (8).

2. Exceptions: a. Section 3.3.1. Fasteners for use in preservative treated wood shall meet the requirements of this article. Fasteners of silicon bronze or copper or stainless steel types 304 or 316, as defined by the American Iron and Steel Institute classification, shall be permitted in preservative treated wood above or below grade. Fasteners or fastener materials not otherwise permitted under this article shall be permitted if adequate comparative tests for durability, including the effects associated with wood treating chemicals, demonstrate performance equal to or greater than the specified fasteners or fastener materials.

(b) *Materials.* All lumber and plywood shall be treated in accordance with the following adopted standard and shall be identified as to conformance with such standard by an approved inspection agency:

1. "Quality Control Program for Soft-Wood Lumber, Timber and Ply-wood Pressure Treated with Water-Borne Preservatives for Ground Contact Use in Residential and Light Commercial Foundations" [s. ILHR 51.27 (6a)].

History: Cr. Register, July, 1974, No. 223, eff. 1-1-75; am. (2) Register, December, 1974, No. 228, eff. 1-1-75; r. and recr. (2), Register, April, 1975, No. 232, eff. 5-1-75; am. (1) (a), (3) and (8) (intro.), cr. (9), Register, December, 1978, No. 276, eff. 1-1-79; reprinted to correct printing error in (8), Register, April, 1980, No. 292; am. (2), Register, December, 1981, No. 312, eff. 1-1-82; am. (9) (a) (intro.), renum. (9) (a) 1.a. to be (9) (a) 2., r. (9) (a) 1.b., Register, December, 1983, No. 336, eff. 1-1-84.

ILHR 53.62 Special systems. (1) **WOOD TRUSSES.** Wood trusses shall be constructed in accordance with the following recommended standard and the listed exceptions:

(a) "Design Specification for Metal Plate Connected Wood Trusses" [s. ILHR 51.27 (10)].

1. Exceptions and additions:

a. Section 302.2. Moment coefficients used in the design of top chord members shall be based on the assumption of no fixity at member ends or joints due to plate connectors. Moment and buckling factors as shown in Table 1 of TPI-78 are acceptable.

b. Metal plate connectors shall be identifiable as stated in s. ILHR 53.61 (8) (a).

c. The modification of design stresses for duration of load shall be as specified in s. ILHR 53.61 (1) (a) 1. c.

(b) For trusses with nail-glued plywood gusset plates, calculations and design reference source shall be submitted to the department.

(c) Mechanically fastened trusses shall conform to section 8.4, "Timber Connector Joints," of National Design Specification [s. ILHR 51.27 (8)].

History: Cr. Register, July, 1974, No. 223, eff. 1-1-75; cr. (1) (a) 1.c., Register, December, 1974, No. 228, eff. 1-1-75; am. (1) (c), Register, December, 1978, No. 276, eff. 1-1-79; am. (1), Register, February, 1979, No. 278, eff. 3-1-79; am. (1)(a) 1.a., Register, January, 1980, No. 289, eff. 2-1-80.

ILHR 53.63 Minimum construction requirements. The requirements of this section shall apply to all wood framing.

Note: Recognized wood framing and construction details indicated in "Wood Construction Data No. 1 and No. 5" of the National Forest Products Association, Technical Services Division (1619 Massachusetts Ave. NW, Washington, D.C. 20036) is recommended as good design and construction practice.

FP (1) **FIRE STOPS.** Fire stops shall be provided at all intersections of interior and exterior walls with floors, ceilings and roof in such manner as to effectively cut off communication by fire through hollow concealed spaces and prevent both vertical and horizontal drafts.

(a) Furred walls shall have fire stops placed immediately above and below the junction of any floor construction with the walls, or shall be fire-stopped the full depth of the joist.

(b) All spaces between chimney and wood framing shall be solidly filled with noncombustible material at floor levels.

(c) All concealed spaces between stair stringers at the top and bottom of the stair run shall be firestopped.

(d) All wood fire stops as required in this section shall be lumber not less than 2 inches in nominal thickness, or $\frac{3}{4}$ inch thick plywood with joints backed, and not less in width than the enclosed space within the partition except as provided for chimneys. Fire stops may also be of $\frac{1}{2}$ " gypsum board or other approved noncombustible materials, securely fastened in place.

(2) WOOD FRAMING INTO FIRE-RATED MASONRY WALLS. See s. ILHR 51.045 (1) (m).

(3) FIRE-CUTTING. Wood members supported in masonry walls shall have the ends of such members splayed or firecut to allow free end rotation in the vertical plane of the member, out of the masonry wall. See also s. ILHR 53.34 (3) (b) 5.b.

(4) BEARING. (a) *Joists and trusses*. The ends of each joist or truss shall have not less than $1\frac{1}{2}$ -inch length of bearing on wood or metal nor less than 3-inch length on hollow or solid masonry units.

(b) *Beams and girders*. The ends of beams or girders supported on masonry or concrete shall have not less than 4-inch length of bearing. See also s. ILHR 53.34 (3).

(5) NOTCHING AND DRILLING. No notching of outer fibers of structural members is permitted unless substantiated by design calculations. Circular holes bored in joists and studs that are within the middle one-third of the depth of joist or studs are permitted without design calculations.

(6) DECAY PREVENTION. Where wood is used in parts of a building exposed to moisture that causes the moisture content of wood to exceed 19%, the wood shall be adequately ventilated or treated with preservative. All lumber and plywood required to be treated with a preservative shall be identified by a quality mark or certificate of inspection of an approved inspection agency which maintains continued supervision, testing and inspection over the quality of the product in accordance with the adopted standards of the American Wood Preservers Bureau.

(a) All wood columns, posts and frame legs whose base is subject to deterioration due to moisture shall bear on concrete or other inorganic materials which extend at least 3 inches above the adjacent surface unless treated with preservative.

(b) The ends of wood structural members built into exterior masonry walls or into concrete shall be treated with preservative or a moisture-proof barrier shall be installed on the bearing surface.

Note: In areas subject to termite attack, refer to "Design of Wood Structures for Permanence" (published by the National Forest Products Association, 1619 Massachusetts Ave. NW, Washington, D.C. 20036) as suggested by National Design Specifications [s. ILHR 51.27 (8)], Appendix F, section B.2.

(7) TRUSS BRACING AND ANCHORAGE. All wood trusses shall be securely fastened to the supports and each truss shall be secured in position in accordance with National Design Specification [s. ILHR 51.27 (8)], Appendix A, section A.10.

(8) ANCHORAGE. Anchorage shall be in accordance with s. ILHR 53.12 (2).

(9) **CROSS BRIDGING.** Cross bridging shall be furnished in accordance with section 4.4.1 of NDS [s. ILHR 51.27 (8)]. When joists support floor or roof decks other than wood or wood decks which are not adequately attached, cross bridging shall be provided at 8-foot intervals.

(10) **SOLID BLOCKING.** All floor and roof joists shall be supported laterally at the ends and at each support by solid blocking or other approved methods. Solid blocking shall be not less than 2 inches in nominal thickness and the full depth of the joist.

(11) **JOIST SUPPORT.** Floor or roof joists shall not be toe nailed into the side of beams and girders for support. Such joists shall be supported by joist hangers, ledgers or metal plate connectors of adequate structural capacity.

(12) **STUD WALLS.** Unless evidence is provided to indicate otherwise, the maximum spacing and height of studs shall be in accordance with Table 53-XVIII. Notching and drilling of studs shall conform to sub. (5). Where load-bearing studs are spaced at 24-inch intervals, the roof trusses, rafters, and joists shall be centered over the studs or, in lieu thereof, solid blocking equal in size to the studs shall be installed to reinforce the double plate above.

(13) **MINIMUM RECOMMENDED NAILING SCHEDULE.** Unless evidence of design for the connection is provided, the connection shall have a minimum nailing in accordance with Table 53-XIX or its equivalent.

TABLE 53-XVIII
MAXIMUM SPACING AND HEIGHT OF STUDS

Size	Grade Referring to Fb and Fc	Height (Feet)	Spacing (Inches)	
			Exterior or Load-Bearing	Interior & Non- Load-Bearing
2 by 4 or larger	Utility	8	16	24
2 by 3	Standard and better ...	8	16	16
2 by 4—3 by 4	Standard and better ...	12	16	24
2 by 6 or larger	Standard and better ...	18	24	24

TABLE 53-X1X
 MINIMUM RECOMMENDED NAILING SCHEDULE

Connection	Nailing (using common nails)
Joist to sill or girder, toe nail.....	3-8d
Bridging to joist, toe nail each end.....	2-8d
Ledger strip.....	3-16d at each joist
1" x 6" subfloor or less to each joist, face nail.....	2-8d
Over 1" x 6" subfloor to each joist, face nail.....	3-8d
2" subfloor to joist or girder, blind and face nail.....	2-16d
Sole plate to joist or blocking, face nail.....	16d at 16" oc
Top plate to stud, end nail.....	2-16d
Stud to sole plate, toe nail.....	4-8d
Doubled studs, face nail.....	16d at 24" oc
Doubled top plates, face nail.....	16d at 16" oc
Top plates, laps and intersections, face nail.....	2-16d
Continuous header, two pieces.....	16d at 16" oc along each edge
Ceiling joists to plate, toe nail.....	3-8d
Continuous header to stud, toe nail.....	4-8d
Ceiling joists, laps over partitions, face nail.....	3-16d
Ceiling joists to parallel rafters, face nail.....	3-16d
Rafter to plate, toe nail.....	3-8d
One-inch brace to each stud and plate, face nail.....	2-8d
1" x 8" sheathing or less to each bearing, face nail.....	2-8d
Over 1" x 8" sheathing to each bearing, face nail.....	3-8d
Built-up corner studs.....	16d at 24" oc
Built-up girders and beams.....	20d at 32" oc along each edge

History: Cr. Register, July, 1974, No. 223, eff. 1-1-75; am. (6) intro., Register, December, 1976, No. 252, eff. 1-1-77; am. (7) and (9), Register, February, 1979, No. 278, eff. 3-1-79; am. (1) and (6) (intro.), Register, December, 1981, No. 312, eff. 1-1-82; am. (10), Register, August, 1985, No. 356, eff. 1-1-86.

ILHR 53.64* Wood foundations. Foundations for 2-story buildings of type 7 and 8 construction or 3 story buildings of type 7 construction may be constructed of treated wood when the design is based upon the soil bearing values contained in s. ILHR 53.21 and the structural design is in accordance with the standards listed in s. ILHR 53.61. All pressure-treated wood and plywood shall be treated and identified in accordance with adopted standards of the American Wood Preservers Bureau as specified in s. ILHR 51.27 (6a).

Note: Section ILHR 51.02 (4) (b) 1. b. requires that exterior walls below the first floor structural system be counted as a story when constructed of materials other than masonry or concrete. Therefore, buildings utilizing wood foundations will be limited to 3 levels (2-story and basement, 2-story and ground floor, or 3-story with treated wood frost wall and no crawl space or basement).

History: Cr. Register, December, 1978, No. 276, eff. 1-1-79; am., Register, December, 1981, No. 312, eff. 1-1-82.

*See Appendix A for further explanatory material.

Chapter ILHR 54

FACTORIES, OFFICE AND MERCANTILE BUILDINGS

ILHR 54.001	Scope (p. 187)	ILHR 54.11	Lighting (p. 195)
ILHR 54.01	Construction, height and allowable area (p. 187)	ILHR 54.12	Sanitary facilities (p. 195)
ILHR 54.02	Number and location of exits (p. 191)	ILHR 54.13	Change rooms and lunch-rooms (p. 199)
ILHR 54.03	Type of exits (p. 192)	ILHR 54.14	Isolation of hazards (p. 199)
ILHR 54.04	Required exit width (p. 193)	ILHR 54.145	Fire extinguishers (p. 200)
ILHR 54.05	Capacity of buildings (p. 193)	ILHR 54.15	Standpipes (p. 200)
ILHR 54.06	Exit doors (p. 193)	ILHR 54.17	Fire alarms (p. 200)
ILHR 54.07	Passageways (p. 193)	ILHR 54.18	Floor load signs (p. 200)
ILHR 54.08	Enclosure of stairways and shafts (p. 194)	ILHR 54.19	Signs indicating number of persons (p. 201)
ILHR 54.10	Trap doors and floor openings (p. 194)	ILHR 54.20	No smoking signs (p. 201)
ILHR 54.105	Toeboards (p. 194)	ILHR 54.21	Tents (p. 201)
		ILHR 54.22	Mini-warehouses (p. 201)

Note: Chapter Ind 54 was renumbered to be chapter ILHR 54 effective January 1, 1984.

ILHR 54.001 Scope. This classification includes all factories and work-shops (including all places where manual labor is employed), office buildings, telegraph and telephone offices, mercantile establishments where commodities are bought or sold, warehouses, railroad stations, exhibition buildings, and places where not more than 100 persons assemble for recreation, entertainment, worship, or dining purposes.

History: 1-2-56; am. Register, December, 1981, No. 312, eff. 1-1-82.

ILHR 54.01 Construction, height and allowable area. (1) **GENERAL.** Buildings and structures within the scope of this chapter may not exceed the height and area limitations specified in this section.

Note: See s. ILHR 51.03 for standards of classes of construction.

(2) **LIMITED AREA CH. ILHR 54 BUILDINGS.** (a) Chapter ILHR 54 buildings not protected by complete automatic fire sprinkler protection may not exceed the height and area limitations specified in Table 54.01-1.

(b) Chapter ILHR 54 buildings protected by complete automatic fire sprinkler systems may not exceed the height and area limitations specified in Table 54.01-2.

(c) Freezer warehouses complying with the requirements of s. ILHR 51.06 (6) (a) 3. b. may be designed and constructed with the allowable floor area as specified in par. (b) and with the allowable increase in exit distance as specified in s. ILHR 54.02 (4) (b) without being protected by a complete automatic fire sprinkler system.

(3) **FIRE DIVISION WALL SEPARATION.** (a) No building shall be limited in area when divided into sections which do not exceed the maximum areas tabulated in this section by fire division walls specified in s. ILHR 51.02 (13).

(b) All openings in such walls shall be protected by fire-resistive door assemblies as specified in s. ILHR 51.047.

1. Except as provided in subd. 2, doors protecting such openings may be left open if equipped with an automatic closing device activated by products of combustion other than heat.

2. a. The automatic closing device may be installed to prevent accidental closing of the fire door in the event of a power outage to the building if it is installed with an approved or listed backup mechanism in addition to the smoke detection release device.

b. The automatic closing device on doors located in smoke- or contaminant-filled environments, such as but not limited to foundries, chemical plants and similar environments, may be activated by rate-of-rise heat detectors.

3. Doors used as required exits shall be standard exit doors and shall comply with the requirements of s. ILHR 51.19 (2).

(4) **UNLIMITED AREAS.** (a) The area of buildings completely protected by an automatic fire sprinkler system may be unlimited provided the following conditions are satisfied:

1. The maximum number of stories is limited as follows:

- a. Type No. 2 construction — 9 stories;
- b. Type No. 3 construction — 5 stories;
- c. Type No. 4 and 5A construction — 3 stories; and
- d. Type No. 5B and 6 construction — 1 story.

2. Street access is provided as specified in sub. (5) (b).

(b) There shall be no area restriction in one-story buildings where the following conditions are satisfied:

1. Construction of all building elements listed in Table 51.03-A are of noncombustible materials. Built-up roof coverings may not be used;

2. a. The contents of the building are noncombustible;

b. Stored materials are not packed or crated in combustible materials; and

3. Street access is provided as specified in sub. (5) (b).

TABLE 54.01-1 — ALLOWABLE HEIGHT (STORIES) AND AREA (SQUARE FEET) FOR BUILDINGS WITHOUT COMPLETE AUTOMATIC FIRE
 SPINKLER SYSTEM PROTECTION (MAXIMUM GROSS FLOOR AREA PER FLOOR)
 NOTE: DO NOT USE FOR BUILDINGS EXCEEDING 60 FEET IN HEIGHT

CLASS OF CONSTRUCTION	BUILDING FRONTAGE STREET EXPOSURE	NUMBER OF STORIES								
		1	2	3	4	5	6	7	8	Over 8
1. Fire-Resistive Type A	1	25,000	22,000	19,000	16,000	13,000	11,000	9,000	8,000	6,000
	2	30,500	27,000	24,000	20,500	17,500	15,000	13,000	12,000	10,000
	3	36,000	33,000	29,000	25,000	22,000	19,000	17,000	16,000	14,000
	4	41,500	39,000	34,000	29,500	26,500	23,000	21,000	20,000	18,000
2. Fire-Resistive Type B	1	23,000	20,000	17,000	14,000	11,000	9,000	7,000	6,000	N.P.
	2	28,000	25,000	22,000	18,500	15,500	13,000	11,000	10,000	
	3	34,000	31,000	27,000	23,000	20,000	17,000	15,000	14,000	
	4	39,500	37,000	32,000	27,500	24,500	21,000	19,000	18,000	
3. Metal Frame Protected	1	21,000	18,000	15,000	12,000	N.P.	N.P.	N.P.	N.P.	N.P.
	2	26,500	23,000	19,500	16,000					
	3	32,000	28,000	24,000	20,000					
	4	37,500	33,000	28,500	24,000					
4. Heavy Timber	1	17,000	14,000	11,000	9,000	N.P.	N.P.	N.P.	N.P.	N.P.
	2	22,000	19,000	16,000	13,500					
	3	27,000	24,000	21,000	18,000					
	4	32,000	29,000	26,000	22,500					
5A. Exterior Masonry Protected	1	15,500	13,500	9,500	8,000	N.P.	N.P.	N.P.	N.P.	N.P.
	2	20,000	17,000	14,000	12,500					
	3	24,500	21,500	18,500	15,500					
	4	29,000	26,000	23,000	19,500					
5B. Exterior Masonry Unprotected	1	14,000	11,500	9,000	N.P.	N.P.	N.P.	N.P.	N.P.	N.P.
	2	18,000	15,000	12,500						
	3	22,000	19,000	16,000						
	4	26,000	23,000	19,500						
6. Metal Frame Unprotected	1	14,000	11,500	9,000	N.P.	N.P.	N.P.	N.P.	N.P.	N.P.
	2	18,000	15,000	12,500						
	3	22,000	19,000	16,000						
	4	26,000	23,000	19,500						
7. Wood Frame Protected	1	12,500	7,500	5,500	N.P.	N.P.	N.P.	N.P.	N.P.	N.P.
	2	16,000	10,000	7,000						
	3	19,000	12,000	8,500						
	4	22,000	14,000	10,000						
8. Wood Frame Unprotected	1	10,000	5,000	N.P.	N.P.	N.P.	N.P.	N.P.	N.P.	N.P.
	2	12,000	6,000							
	3	14,000	7,000							
	4	16,000	8,000							

Factories, office, mercantile

INDUSTRY, LABOR AND HUMAN RELATIONS
 IJHR 54 189

TABLE 54.01-2 — ALLOWABLE HEIGHT (STORIES) AND AREA (SQURE FEET) FOR BUILDINGS COMPLETELY PROTECTED BY AUTOMATIC FIRE SPRINKLER SYSTEM (MAXIMUM GROSS FLOOR AREA PER FLOOR) NOTE: USE FOR ALL BUILDINGS

CLASS OF CONSTRUCTION	BUILDING FRONTAGE STREET EXPOSURE	NUMBER OF STORIES									
		1	2	3	4	5	6	7	8	9	Over 9
1. Fire-resistive Type A stories and area may be unlimited subject to s. ILHR 54.01 (5) (b)	1	NO LIMIT									
	2	NO LIMIT									
	3	NO LIMIT									
	4	NO LIMIT									
2. Fire-resistive type B 1 to 9 story area may be unlimited subject to s. ILHR 54.01 (5) (b)	1		69,000	60,000	51,000	42,000	33,000	27,000	21,000	18,000	N.P.
	2	NO	85,500	75,000	66,000	55,500	46,500	39,000	33,000	30,000	N.P.
	3	LIMIT	102,000	93,000	81,000	69,000	60,000	51,000	45,000	42,000	N.P.
	4		118,500	111,000	96,000	82,500	73,500	63,000	57,000	54,000	N.P.
3. Metal frame protected 1 to 5 story area may be unlimited subject to s. ILHR 54.01 (5) (b)	1	84,000	63,000	54,000	45,000	36,000	N.P.	N.P.	N.P.	N.P.	N.P.
	2	106,000	79,500	69,000	58,500	48,000	N.P.	N.P.	N.P.	N.P.	N.P.
	3	128,000	96,000	84,000	72,000	60,000	N.P.	N.P.	N.P.	N.P.	N.P.
	4	150,000	112,500	99,000	85,500	72,000	N.P.	N.P.	N.P.	N.P.	N.P.
4. Heavy Timber 1 to 3 story area may be unlimited subject to s. ILHR 54.01 (5) (b)	1	68,000	51,000	42,000	33,000	27,000	N.P.	N.P.	N.P.	N.P.	N.P.
	2	88,000	66,000	57,000	48,000	40,500	N.P.	N.P.	N.P.	N.P.	N.P.
	3	108,000	81,000	72,000	63,000	54,000	N.P.	N.P.	N.P.	N.P.	N.P.
	4	128,000	96,000	87,000	78,000	67,500	N.P.	N.P.	N.P.	N.P.	N.P.
5A. Exterior Masonry Protected 1 to 3 story area may be unlimited subject to s. ILHR 54.01 (5) (b)	1	62,000	46,500	40,500	28,500	24,000	N.P.	N.P.	N.P.	N.P.	N.P.
	2	80,000	60,000	51,000	42,000	37,500	N.P.	N.P.	N.P.	N.P.	N.P.
	3	98,000	73,500	64,500	55,500	46,500	N.P.	N.P.	N.P.	N.P.	N.P.
	4	116,000	87,000	78,000	69,000	58,500	N.P.	N.P.	N.P.	N.P.	N.P.
5B. Exterior Masonry Unprotected 1 story area may be unlimited subject to s. ILHR 54.01 (5) (b)	1	56,000	42,000	34,500	27,000	N.P.	N.P.	N.P.	N.P.	N.P.	N.P.
	2	72,000	54,000	45,000	37,500	N.P.	N.P.	N.P.	N.P.	N.P.	N.P.
	3	88,000	66,000	57,000	48,000	N.P.	N.P.	N.P.	N.P.	N.P.	N.P.
	4	104,000	78,000	69,000	58,500	N.P.	N.P.	N.P.	N.P.	N.P.	N.P.
6. Metal Frame Unprotected 1 story area may be unlimited subject to s. ILHR 54.01 (5) (b)	1	56,000	42,000	34,500	27,000	N.P.	N.P.	N.P.	N.P.	N.P.	N.P.
	2	72,000	54,000	45,000	37,500	N.P.	N.P.	N.P.	N.P.	N.P.	N.P.
	3	88,000	66,000	57,000	48,000	N.P.	N.P.	N.P.	N.P.	N.P.	N.P.
	4	104,000	78,000	69,000	58,500	N.P.	N.P.	N.P.	N.P.	N.P.	N.P.
7. Wood Frame Protected	1	50,000	37,500	22,500	16,500	N.P.	N.P.	N.P.	N.P.	N.P.	N.P.
	2	64,000	48,000	30,000	21,000	N.P.	N.P.	N.P.	N.P.	N.P.	N.P.
	3	76,000	57,000	36,000	25,500	N.P.	N.P.	N.P.	N.P.	N.P.	N.P.
	4	88,000	66,000	42,000	30,000	N.P.	N.P.	N.P.	N.P.	N.P.	N.P.
8. Wood Frame Unprotected	1	40,000	30,000	15,000	N.P.	N.P.	N.P.	N.P.	N.P.	N.P.	N.P.
	2	48,000	36,000	18,000	N.P.	N.P.	N.P.	N.P.	N.P.	N.P.	N.P.
	3	56,000	42,000	21,000	N.P.	N.P.	N.P.	N.P.	N.P.	N.P.	N.P.
	4	64,000	48,000	24,000	N.P.	N.P.	N.P.	N.P.	N.P.	N.P.	N.P.

N.P. MEANS NOT PERMITTED

(5) **STREET ACCESS TO BUILDINGS.** (a) Streets shall be within 50 feet of the adjacent building side with no obstructions between the street and the building which will impede fire-fighting efforts.

Note: See s. ILHR 51.01 (124) for definition of street.

(b) 1. Except as provided in subd. 2., buildings with no area limitations shall have a continuous all-weather, hard-surfaced area 30 feet or more in width for a distance of not less than 50% of the perimeter of the building. These buildings shall have at least one wall facing a street for its entire length. At least 2 of the remaining building walls shall face streets for at least 50% of their respective lengths.

2. Unlimited area buildings of fire-resistive type 1 construction and one-story unlimited area buildings of fire-resistive type 2 construction shall be provided with street access as defined in s. ILHR 51.01 (124) to at least one side of the building.

(6) **HEIGHT EXCEPTIONS.** Rack storage facilities of noncombustible construction protected with automatic fire sprinkler systems installed in accordance with NFPA No. 231C — Standard for Rack Storage of Materials, may be of unlimited height.

History: 1-2-56; am. (2) and (3), Register, September, 1959, No. 45, eff. 10-1-59; am. (3), Register, February, 1971, No. 182, eff. 7-1-71; r. and recr. (3), eff. 8-1-71 and exp. 1-1-72; cr. (3) eff. 1-1-72, Register, July, 1971, No. 187; r. and recr. (1) and (2), Register, June, 1972, No. 198, eff. 1-1-73; r. and recr. (2) and (3), Register, September, 1973, No. 213, eff. 10-1-73; cr. (2) (a) 2 a, Register, December, 1977, No. 264, eff. 1-1-78; am. (2) (b) 2. a. and (2) (c), cr. (4), Register, November, 1978, No. 276, eff. 1-1-79; am. (3), Register, January, 1980, No. 289, eff. 2-1-80; r. and recr. table, am. (2) (b) 2. and (3), Register, December, 1981, No. 312, eff. 1-1-82; reprinted to correct errors in Table 54.01 and (2) (b) 2., Register, February, 1982, No. 314; am. (3), Register, December, 1983, No. 336, eff. 1-1-84; renum. (2) (a) and (c) to be (2) (a) 1. and (d), (2) (a) 2. renumb. and am. from ILHR 54.23, am. (2) (b) 1. and 2., r. and recr. (2) (b) 3., cr. (2) (c), Register, August, 1985, No. 356, eff. 1-1-86; emerg. r. and recr. (1) to (4), cr. (5) and (6) and tables 54.01-1 and 54.01-2, r. table 54.01, eff. 9-6-86; r. and recr. (1) to (4), cr. (5), (6) and tables 54.01-1 and 54.01-2, r. table 54.01, Register, November, 1986, No. 371, eff. 12-1-86.

ILHR 54.02 Number and location of exits. (1) **NUMBER OF EXITS.** Every building and every floor level thereof shall have at least 2 exits.

(2) **EXCEPTIONS.** One exit will be permitted in the following conditions:

(a) Floor levels used entirely for storage in buildings 2 stories or less in height and not over 3,000 square feet gross area per floor.

(b) Interior balconies or mezzanine floors not over 3,000 square feet gross area used entirely for storage.

(c) Open interior balconies or open mezzanine floors not over 750 square feet gross area used for purposes other than nonoccupied storage.

(d) One-story office buildings, without a basement or mezzanine, having a gross floor area, per floor, of not more than 1,800 square feet. Only one office operation per floor level shall be permitted. The single exit from the first floor or ground floor(s) shall be an outside exit serving only that floor level.

(e) Retail establishments not over 750 square feet net area, provided there are 2 directions for exiting from the entrance door of the store.

(3) **OFFICE SUITE EXITING.** One exit will be permitted from office suites having a floor area of not more than 1,800 square feet net area, provided there are 2 directions for exiting from the entrance door of the suite.

(4)* **EXIT DISTANCE.** (a) Exits shall be distributed or located so that no part of any building within the scope of this chapter will be more than 150 feet distant from an exit.

(b) Where an approved automatic fire sprinkler system is provided throughout the building, an increase in exit distance to 200 feet will be permitted for mercantile buildings and an increase in exit distance to 300 feet will be permitted in all other buildings within the scope of this chapter, except high hazard buildings.

(c) Buildings having contents which are liable to burn with extreme rapidity or from which poisonous fumes may be liberated or explosions occur in case of fire, shall have exits provided so that the maximum distance to exit is limited to 75 feet.

Note: See s. A52.015 of Appendix A for further information relating to "high hazard" occupancies.

(d) All of the above distances shall be measured along public passageways and aisles.

Note: Also see s. ILHR 54.08 (1) for alternate exit distance provisions.

(5) **EXIT DISTRIBUTION.** Exits in all buildings of this classification shall be so located and distributed so as to afford the best possible egress.

History: 1-2-56; cr. (1) (c), Register, September, 1959, No. 45, eff. 10-1-59; am. (1) (b), Register, February, 1971, No. 182, eff. 7-1-71; r. and recr. (1) (b) eff. 8-1-71 and exp. 1-1-72, and cr. (1) (b) eff. 1-1-72, Register, July, 1971, No. 187; am. (1), Register, September, 1973, No. 213, eff. 10-1-73; r. and recr. Register, December, 1978, No. 276, eff. 1-1-79; am. (4), Register, January, 1980, No. 289, eff. 2-1-80; am. (4), Register, December, 1981, No. 312, eff. 1-1-82; emerg. am. (4) (b), eff. 9-6-86; am. (4) (b), Register, November, 1986, No. 371, eff. 12-1-86.

ILHR 54.03 Type of exits. (1) At least one-half of the exits required in accordance with s. ILHR 54.02 shall be stairways or standard exits to grade as specified in ss. ILHR 51.15-51.18. The other exits shall be either stairways, standard exits, or horizontal exits as specified in s. ILHR 51.19, or fire escapes as specified in s. ILHR 51.20. A fire escape will not be accepted as a required exit for any building level more than 5 stories or 55 feet above grade. An outside wooden stairway may be used as an exit for a 2-story building.

(a) *Exception.* The width of required exit stairways serving unoccupied areas (i.e., storage areas, equipment mezzanines and similar areas) not exceeding 750 square feet may be reduced to 3 feet 0 inches.

(b) *Exception.* Less than 3 risers may be used to elevated work stations (such as pharmacy floors, computer floors and similar areas) or to altars, podiums and similar areas, not in a required exit passageway.

(c) *Exception.* A spiral stairway may be used as a nonrequired convenience stairway in addition to all other required exit stairways in places of employment.

*See Appendix A for further explanatory material.

(d) *Exception.* A rescue platform (exterior balcony) of combustible construction may be used as a required second exit for buildings of type 7 and 8 construction, provided the following conditions are satisfied:

1. The exit serves 8 or less people;
2. The exit platform is located not more than 10 feet above the adjacent exit discharge grade;
3. The platform area is at least 14 square feet, with a minimum dimension of 3 feet;
4. The platform is designed for 80 pounds per square foot live load plus dead load;
5. Railings are provided in accordance with the provisions of s. ILHR 51.162;
6. Platforms having solid floors are provided with a roof equal in area to that of the platform; and
7. All wood used in the construction of the rescue platform shall be pressure treated wood satisfying the requirements of the applicable standards specified in s. ILHR 51.27 (6a) unless the wood is inherently resistant to decay.

(2) Every building which will accommodate more than 50 persons above the second story shall have at least 2 stairways.

(3) Wherever stairways are required under this classification, ramps with a slope not greater than one foot in 8 feet may be substituted. Ramps shall comply with all the requirements for stairways as to construction, enclosures, width, landing and lighting, and shall be surfaced with an approved non-slip material.

History: 1-2-56; am. (1), Register, December, 1974, No. 228, eff. 1-1-75; cr. (1) (a) to (d), Register, December, 1977, No. 264, eff. 1-1-78; am. (1) (b), Register, December, 1978, No.

DEPT. OF INDUSTRY, LABOR AND HUMAN RELATIONS 193
Factories, office, mercantile ILHR 54

276, eff. 1-1-79; am. (1) (d) 5. and (3), Register, January, 1980, No. 289, eff. 2-1-80; am. (1) (d) (intro.) 5. and 6., cr. (1) (d) 7., Register, December, 1983, No. 336, eff. 1-1-84.

ILHR 54.04 Required exit width. (1) The total required exit width from a building level shall be in accordance with the requirements of ss. ILHR 51.15 (6) and 51.16 (3). **FP**

(2) Standard fire escapes (s. ILHR 51.20) may be substituted for stairways to the extent of not more than 1/2 of the required total width, subject to the provision of s. ILHR 54.02.

(3) Horizontal exits in accordance with the requirements of s. ILHR 51.19 may provide up to one-half of the required exit width for any floor, subject to the provisions of s. ILHR 54.02.

History: 1-2-56; am. (1) (a) and (b) and (3) (a) and (b), Register, June, 1972, No. 198, eff. 1-1-73; r. and recr. (1) and (3), r. (4), Register, December, 1974, No. 228, eff. 1-1-75.

ILHR 54.05 Capacity of buildings. (1) In calculating the aggregate width of exits, the capacity of the buildings shall be established as follows:

- (a) Stores, first floor and basement ----- 30 sq. ft. per person
- (b) Stores, second floor and above ----- 60 sq. ft. per person
- (c) Dining rooms, cafes, taverns, etc. ----- 10 sq. ft. per person
- (d) Places of seated assemblage----- 7 sq. ft. per person
- (e) Warehouses ----- 300 sq. ft. per person
- (f) Factories and offices ----- 75 sq. ft. per person

(2) The above figures are based on the net area of each occupied space. Where dining rooms, cafes, dance halls and places of seated assemblage accommodate more than 100 persons, see s. ILHR 55.01.

(3) In other occupancies not specified above, the capacity shall be determined by the actual number of persons liable to be accommodated therein and no greater number of persons will be permitted therein.

ILHR 54.06 Exit doors. (1) **GENERAL.** Except as provided in pars. (a) and (b), every door which serves as an exit from a building, public passageway or stairway shall be a standard exit door as specified in s. ILHR 51.15. **FP**

(a) Exit doors serving 25 or less persons need not swing in the direction of egress.

(b) Exit access doors serving 25 or less persons may be reduced in width to 2 feet 8 inches and may be sliding or accordian-type doors.

(2) **ILLUMINATED EXIT SIGNS.** Every exit door from each floor, other than the principal entrance on the first floor, shall be marked with exit signs as specified in s. ILHR 51.15 (5).

History: 1-2-56; am. (1), Register, December, 1978, No. 276, eff. 1-1-79; am. Register, January, 1980, No. 289, eff. 2-1-80; am. Register, December, 1983, No. 336, eff. 1-1-84.

ILHR 54.07 Passageways. Where there is not direct access to outside exit doors, safe and continuous passageways, aisles or corridors leading directly to every exit shall be maintained at all times on all floors of all **FP**

buildings. Every passageway, aisle or corridor shall conform in width to the rule for width of stairways as specified in ss. ILHR 51.15 (6) and 51.16 (3). Widths shall be measured in the clear, at their narrowest points produced by any projection, radiator, pipe or other object and the required width shall be maintained clear and unobstructed at all times.

History: 1-2-56; am. Register, December, 1981, No. 312, eff. 1-1-82.

FP ILHR 54.08 Enclosure of stairways and shafts. (1) (a) Except as provided in par. (b), all stairways including landings, ramps and shafts, shall be enclosed as specified in s. ILHR 51.02 (11).

(b) 1. The stairways or shafts connecting the first floor with one floor level immediately adjacent to it (e.g., second story, mezzanine, ground floor or basement) may be left open in buildings 2 stories or less in height, and where the distance to an exit from the area served by the open stairway including the horizontal travel distance on the exit access stair, does not exceed 100 feet in buildings not completely protected by an approved automatic sprinkler system or 150 feet in buildings completely protected by an approved automatic sprinkler system; or

2. Any stairway or shaft connecting the second floor, first floor and basement or ground floor shall be separated at the first floor level or first adjacent basement or ground floor level with fire resistive construction as specified in Table 51.03-A or better in buildings 2 stories or less in height, and where the distance to an exit from the area served by the open stairway including the horizontal travel distance on the exit access stair, does not exceed 100 feet in buildings not completely protected by an approved automatic sprinkler system or 150 feet in buildings completely protected by an approved automatic sprinkler system.

(2) All doors opening into such enclosures shall be as specified in s. ILHR 51.047, and all windows shall be of wired glass and metal frames and sash.

Note: See ch. Ind 4 for requirements governing the installation and operation of elevators.

History: 1-2-56; am. (1) (a), (b), (c), (d) and (2), Register, February, 1971, No. 182, eff. 7-1-71; r. and recr. (1) (a), (b), (c), (d) and (2) eff. 8-1-71 and exp. 1-1-72; cr. (1) (a), (b), (c), (d) and (2) eff. 1-1-72, Register, July, 1971, No. 187; r. and recr. (1), Register, June, 1972, No. 198, eff. 1-1-73; am. (3), Register, December, 1977, No. 264, eff. 1-1-78; r. (3), Register, December, 1978, No. 276, eff. 1-1-79; am. (1), Register, January, 1980, No. 289, eff. 2-1-80; am. (1), Register, October, 1982, No. 322, eff. 11-1-82; am. (1) (b), Register, December, 1983, No. 336, eff. 1-1-84.

ILHR 54.10 Trap doors and floor openings. Every opening through any floor or through any roof used by the public or by employees shall be guarded by a substantial enclosure or rail not less than 3 feet 6 inches high. Floor openings in buildings of more than 2 stories, unless enclosed with fire-resistive enclosures as specified in s. ILHR 54.08 shall be protected by fire-resistive doors as specified in s. ILHR 51.047.

History: 1-2-56; am. Register, February, 1971, No. 182, eff. 7-1-71; r. and recr. eff. 8-1-71 and exp. 1-1-72; Register, July, 1971, No. 187.

ILHR 54.105 Toeboards. A toeboard shall be provided at the exposed edges of all elevated platforms, walks, balconies, mezanines, ramps and floor openings to prevent the fall of materials where the elevation difference is greater than 5 feet. The toeboard shall extend 4 inches above the finished floor. Where material is stockpiled to a height where the toeboard does not provide adequate protection, additional measures shall be taken to prevent the fall of materials.

Register, August, 1985, No. 356

(1) **EXCEPTION.** Toeboards are not required on stairways or ramps and their landings or platforms.

History: Cr. Register, December, 1981, No. 312, eff. 1-1-82.

ILHR 54.11 Lighting. (1) (a) Except as provided in par. (b), all stairways, fire escapes and exits and the passageways leading thereto when used at night shall be properly illuminated to facilitate egress. The intensity of illumination shall be as specified in ch. Ind 19.

(b) The level of intensity of illumination for fire escapes may be reduced to 2.5 foot candles.

(2) All gas jets or gas lights in factories or workshops where combustible material is used, shall be properly enclosed by globes or wire cages, or otherwise properly guarded.

History: 1-2-56; am. (1), Register, August, 1985, No. 356, eff. 1-1-86.

ILHR 54.12 Sanitary facilities. (1) **TOILET ROOMS.** The occupancies included under the scope of this chapter shall be provided with toilet rooms as outlined in this section.

(a) *Factories, office and mercantile buildings.* All factories, office and mercantile buildings shall be provided with separate toilet rooms for each sex, except as follows:

1. Where not more than 10 employes and 25 patrons are accommodated, one toilet room, shared in common, may be provided if the door of the toilet room is equipped with a lock to ensure privacy.

2. Separate toilet rooms for the employes and the general public need not be provided if the toilet rooms are accessible to both employes and the general public.

3. Toilet facilities need not be provided in buildings and structures which provide service to people in automobiles, such as drive-in bank teller booths, photography and film service booths, or parking lot attendant booths, but not including drive-in restaurants, provided that a written statement is submitted to the department showing proof that convenient toilet facilities are available during all periods of operation. The requirement for toilet facilities is also waived for mobile crews and for unattended buildings, provided the employes have access to available toilet facilities.

(b) *Shopping centers.* In shopping centers, separate toilet rooms for each sex shall be provided for use by the general public. The toilet rooms may be located in the public mall or in the individual stores. Separate toilet rooms for each sex shall be provided for the employes in each store. In stores which accommodate not more than 10 employes and 25 patrons, one toilet room to accommodate both sexes will be acceptable. A store which has a net area of 750 square feet or less is not required to be provided with toilet rooms for the employes if the employes have access to the public toilet rooms located in the mall.

Note #1: The department recommends that public toilet rooms in the mall be conveniently located for patron use and that the travel distance between sets of public toilet rooms be less than 400 feet.

Note #2: See ss. ILHR 54.12 (1) (d) and 55.32 for requirements for toilet rooms for other use groups which may also be included in shopping centers.

(c) *Places of worship.* Places of worship which are included under the scope of this chapter shall be provided with separate toilet rooms for each sex.

(d) *Places for entertainment, recreation and seated dining.* Restaurants, taverns, and places for entertainment and recreation which are included under the scope of this chapter shall be provided with separate toilet rooms for each sex. Separate toilet rooms for employes and the general public are not required.

Note: See ch. HSS 196, Wis. Adm. Code, rules of the department of health and social services, for supplementary requirements for toilet room facilities in restaurants.

(e) *Garages, service stations and filling stations.* Toilet rooms shall be provided in accordance with the requirements of this subsection.

1. *Garages.* Separate toilet rooms for each sex shall be provided in all service and repair garages, body shops, automobile tire and battery shops, and buildings of similar use, except that a single toilet room, shared in common, may be provided in buildings which accommodate not more than 10 employes and 25 patrons. Separate toilet rooms for employes and patrons need not be provided if toilet rooms are accessible to both employes and patrons.

2. *Service stations and filling stations.* Separate toilet rooms for each sex shall be provided in service stations and filling stations, including self-service stations. Separate toilet rooms for employes and patrons need not be provided if toilet rooms are accessible to both employes and patrons.

(2) *Sanitary fixtures.* In public buildings and places of employment, except taverns, restaurants, filling stations and service stations, the total number of sanitary fixtures required in the building shall be based upon the total number of occupants of the building and shall be determined from the ratios established in Table 54.12-A, but in no case shall the ratio of the number of fixtures to the number of employes be less than those specified in Table 54.12-B. The total number of occupants will be considered equally divided between men and women unless a different ratio is approved by the department. The requirements of this section do not apply to the buildings exempt from toilet rooms under s. ILHR 54.12 (1).

(a) *Exceptions:* 1. a. Except as provided in subpar. b, taverns and restaurants shall provide at least one toilet room for each sex.

b. One toilet room having at least one water closet (WC) and one lavatory (L) may be shared in common by both sexes in restaurants providing seating for 15 or less patrons provided the door of the toilet room is equipped with a lock to ensure privacy. Separate toilet rooms for the employes and the general public need not be provided if the toilet rooms are accessible to both employes and the general public.

c. Restaurants accommodating 16 to 50 total occupants shall provide at least one water closet (WC) and one lavatory (L) for each sex.

d. Taverns and restaurants accommodating 50 to 100 occupants in total shall provide at least 2 water closets (WC) and one lavatory (L) for the females and at least one water closet (WC), one urinal (U) and one lavatory (L) for the males.

e. Taverns and restaurants accommodating more than 100 occupants in total shall be provided with sanitary fixtures as specified in Table 55.32.

**TABLE 54.12-A
NUMBER OF FIXTURES REQUIRED FOR OCCUPANTS**

Number of Occupants	Type of Fixture					
	Water Closets (WC)		Urinals (U)	Lavatories (L)	Showers (S) ¹	Drinking Facilities (DF)
	Males (M)	Females (F)	Males (M)			
1- 100 occupants of each sex	1	1	0	One (L) for each 2 required (WC) or (U), or both or fraction	None required	One (DF) for each 150 occupants up to 600 or fraction
101- 200 occupants of each sex	1	2	1			
201- 300 occupants of each sex	1	3	2			
301- 400 occupants of each sex	2	4	2			
401- 500 occupants of each sex	2	5	3			
501- 600 occupants of each sex	2	6	4			
Over 600 occupants of each sex	One (WC) for each additional 600 (M), or fraction	One (WC) for each additional 275 (F), or fraction	One (U) for each additional 500 (M), or fraction			One additional (DF) for each additional 3000 occupants, or fraction

¹Showers shall be provided in public pool facilities and for occupants exposed to occupational hazards such as poisons, infectious or irritating materials.

TABLE 54.12-B
NUMBER OF FIXTURES REQUIRED FOR EMPLOYEES

Number of Employees	Type of Fixture					
	Water Closets (WC)		Urinals (U)	Lavatories (L)	Showers (S) ¹	Drinking Facilities (DF)
	Males (M)	Females (F)	Males (M)			
0- 15 employees of each sex	1	1	0	One (L) for each 2 (WC) required or (U), or fraction	One (S) for each 10 employees of each sex, or fraction	One (DF) for each 100 employees, or fraction
16- 35 employees of each sex	1	2	1			
36- 55 employees of each sex	2	3	1			
56- 80 employees of each sex	2	4	2			
81-110 employees of each sex	3	5	2			
111-150 employees of each sex	4	6	2	One additional fixture for each additional 40 employees of each sex; 2/3 of the additional water closets for males may be urinals.		
Over 150 employees of each sex						

¹Showers shall be provided in public pool facilities and for employees exposed to occupational hazards such as poisons, infectious or irritating materials.

Note #1: *Examples:* Example #1: Mercantile building with 300 patrons and 50 employees = 350 total occupants; equally divided between sexes = 175 males, 175 females. From Table 54.12-A, 101-200 occupants of each sex: males require one water closet, one urinal, one lavatory; females require 2 water closets, one lavatory. Check for compliance with Table 54.12-B for employees: 50 employees, equally divided between sexes = 25 males, 25 females; 16-35 employees of each sex, males require one water closet, one urinal, one lavatory; females require 2 water closets, one lavatory. Therefore, the number of fixtures required by Table 54.12-A also satisfies the requirements of Table 54.12-B for employees and patrons.

Example #2: Office building with 300 employees and 50 patrons = 350 total occupants; equally divided between sexes = 175 males, 175 females. From Table 54.12-A, 101-200 occupants of each sex: males require one water closet, one urinal, one lavatory; females require 2 water closets, one lavatory. Check for compliance with Table 54.12-B for employees: 300 employees, equally divided between sexes = 150 males, 150 females; 111-150 employees of each sex, males require 4 water closets, 2 urinals, 3 lavatories; females require 6 water closets, 3 lavatories. Therefore, the number of fixtures required by Table 54.12-B for employees is more restrictive and governs.

Note #2: The ratios established in Table 54.12-B for employees are taken directly from the U.S. Department of Labor, Occupational Safety and Health Act (OSHA) regulations. Therefore, s. ILHR 50.25, petitions for variance, is not applicable to the requirements of this table.

Note #3: See also rules of the department of health and social services for sanitary fixtures for public swimming places, mobile home parks, camping grounds, camping resorts, recreational camps and educational camps.

Note #4: See Ch. Ind 1000-2000—Wis. Safety and Health Code, for additional washing facilities required in places of employment where environmental hazards are present.

2. Filling stations and service stations shall provide at least one toilet room for each sex. A minimum of one water closet (WC) and one lavatory (L) shall be provided for each sex, but in no case shall the ratio of number of fixtures to number of employes be less than those specified in Table 54.12-B.

History: 1-2-56; am. (3) (a) and (b), and (6), Register, September, 1959, No. 45, eff. 10-1-59; r. and recr. Register, December, 1976, No. 252, eff. 1-1-77; am. (1) (a) 1, (1) (b) and (e) 1, r. (1) (e) 3, r. and recr. (2), Register, December, 1977, No. 264, eff. 1-1-78; am. (2) (intro.) and (2) (a) 2., Register, December, 1978, No. 276, eff. 1-1-79; r. and recr. table and (2) (a) 1., Register, December, 1981, No. 312, eff. 1-1-82; r. and recr. (2) (a) 1., Register, October, 1982, No. 322, eff. 11-1-82; am. (1) (a) 1. and (e) 1., Register, December, 1983, No. 336, eff. 1-1-84; am. table 54.12 A and B, r. (2) (a) 1. a., renum. (2) (a) 1. intro., b. and c. to be a. d. and e. and am. a., cr (2) (a) 1. b. and c., Register, August, 1985, No. 356, eff. 1-1-86.

ILHR 54.13 Change rooms and lunchrooms. (1) **CHANGE ROOMS.** Change rooms equipped with storage facilities for street clothes shall be provided where employes are required to wear protective clothing due to the nature of the employment and where employes are exposed to toxic materials and industrial poisons. Separate storage facilities for street clothes and work clothes shall be provided for employes who work with industrial poisons.

Note: See also ch. HSS 196, Wis. Adm. Code, rules of the department of health and social services, for requirements for dressing rooms and lockers in restaurants.

(2) **LUNCHROOMS.** A space for eating lunches shall be provided in all places of employment where there is exposure to injurious dusts, toxic material and industrial poisons. Such space shall be physically separate from any location where there is exposure to toxic materials. Toilet rooms shall not be permitted to serve as lunchrooms.

History: Cr. Register, December, 1976, No. 252, eff. 1-1-77.

ILHR 54.14 Isolation of hazards. (1) **GENERAL.** (a) Except as provided **FP** in par. (b), all fuel-fired heating boilers and furnaces, power boilers, fuel rooms and breeching, storage vaults for paints, oils, and similar combustibles and other similar hazards in a building shall be isolated from the rest of the building by at least a 2-hour fire-resistive enclosure as specified in ss. ILHR 51.04 to 51.049; except that in buildings not more than 2 stories in height and having a floor area of not more than 3,000 square feet per floor, a 1-hour fire-resistive enclosure as specified in ss. ILHR 51.04 to 51.049, or better, shall be provided.

Note: See ch. ILHR 10, for isolation of flammable and combustible liquids.

(b) Direct vent sealed combustion chamber appliances need not be enclosed with fire-resistive rated construction as specified in par. (a).

(2) **PROTECTION OF OPENINGS.** All openings shall be protected with self-closing fire-resistive doors as specified in s. ILHR 51.047.

(3) **SUSPENDING EQUIPMENT.** (a) Except as provided in par. (b), boilers up to 200,000 Btu input, water heaters up to 200,000 Btu input, gas and liquid fuel-fired space heaters, suspended furnaces, vented and unvented unit heaters may be used without an enclosure where approved by the department. Where suspended furnaces, vented and unvented unit heaters, boilers and water heaters are used without an enclosure, all such units shall be located at least 7 feet above the floor. The blow-off pipe for suspended boilers and water heaters shall be extended down to within 6 inches of the floor.

(b) The rated enclosure for heating equipment in factories may be omitted if the burner of the equipment is located at least 7 feet off the floor and the equipment is protected from physical damage.

Note: See s. ILHR 64.21 for additional requirements.

History: 1-2-56; am. (1) and (2), Register, February, 1971, No. 182, eff. 7-1-71; r. and recr. (1) and (2) eff. 8-1-71 and exp. 1-1-72; cr. (1) and (2) eff. 1-1-72, Register, July, 1971, No. 187; renum. from 54.13, Register, December, 1976, No. 252, eff. 1-1-77; am. (3), Register, December, 1978, No. 276, eff. 1-1-79; am. Register, December, 1981, No. 312, eff. 1-1-82; am. (3), Register, October, 1982, No. 322, eff. 11-1-82; r. and recr. (3), Register, December, 1983, No. 336, eff. 1-1-84; am. (1), Register, August, 1985, No. 356, eff. 1-1-86.

FP ILHR 54.145* FIRE EXTINGUISHERS. Portable fire extinguishers shall be provided and maintained as specified in s. ILHR 51.22.

History: Cr. Register, December, 1981, No. 312, eff. 1-1-82.

FP ILHR 54.15 Standpipes. (1) **FIRE DEPARTMENT STANDPIPES.** Fire department standpipes shall be provided in all buildings exceeding 60 feet in height.

(2) **STANDPIPES.** Dry standpipes shall be provided in all buildings 3 stories or more in height in which the floor area of each story is more than 3,000 square feet, unless an approved automatic sprinkler system is installed. First-aid standpipes may be provided in lieu of dry standpipes in factory occupancies.

History: 1-2-56; renum. from 54.14 and r. and recr. Register, December, 1976, No. 252, eff. 1-1-77; am. (2), Register, December, 1977, No. 264, eff. 1-1-78; emerg. r. and recr. (2), eff. 9-6-86; r. and recr. (2), Register, November, 1986, No. 371, eff. 12-1-86.

FP ILHR 54.17 Fire alarms. (1) **FACTORY AND WORKSHOP.** Except as provided in sub. (3), a manual fire alarm complying with the requirements of s. ILHR 51.24 shall be provided in every factory or workshop where more than 10 persons are employed above the second story.

(2) **OFFICE BUILDINGS.** Except as provided in sub. (3), a manual fire alarm complying with the requirements of s. ILHR 51.24 shall be provided in office buildings complying with either of the following conditions:

(a) Four stories or more in height; or

(b) 15,000 square feet or more on any floor level above or below a floor of exit discharge.

(3) **EXCEPTION.** The installation of a manual fire alarm system may be omitted in buildings where complete automatic fire sprinkler system protection is provided.

History: 1-2-56; am. Register, June, 1972, No. 198, eff. 1-1-73; renum. from 54.16, Register, December, 1976, No. 252, eff. 1-1-77; r. and recr. Register, December, 1981, No. 312, eff. 1-1-82; emerg. r. and recr., eff. 9-6-86; r. and recr. Register, November, 1986, No. 371, eff. 12-1-86.

ILHR 54.18 Floor load signs. (1) In every factory, workshop, warehouse, or other building where material is piled, notices of a permanent character shall be painted or otherwise prominently displayed, stating the live load in pounds per square foot which the floor is designed to carry. Such notices shall be placed in full view, on each floor.

*See Appendix A for further explanatory material.

(2) Where floors are always used for the storage of some particular material, the walls shall be marked to the height to which the material shall be piled without exceeding the safe load.

History: 1-2-56; renum. from 54.17, Register, December, 1976, No. 252, eff. 1-1-77.

ILHR 54.19 Signs indicating number of persons. In all buildings of this classification where 50 or more persons are accommodated on any floor above the second, notices shall be prominently displayed stating the maximum number of persons on each floor for whom stairways and other exits have been provided according to ss. ILHR 54.02—54.06. Such notices shall be placed in full view, on each floor.

History: 1-2-56; renum. from 54.18, Register, December, 1976, No. 252, eff. 1-1-77.

ILHR 54.20 No smoking signs. Smoking shall not be permitted in retail establishments where flammable materials are handled or sold. Suitable signs bearing the words "No Smoking" shall be erected in all places where such hazard exists. FP

History: 1-2-56; renum. from 54.19, Register, December, 1976, No. 252, eff. 1-1-77.

ILHR 54.21 Tents. All tents used for sales or storage purposes shall conform to the requirements specified in ss. ILHR 62.42—62.51.

History: Cr. Register, September, 1959, No. 45, eff. 10-1-59; renum. from 54.20, Register, December, 1976, No. 252, eff. 1-1-77; am. Register, December, 1981, No. 312, eff. 1-1-82.

ILHR 54.22 Mini-warehouses. (1) **SCOPE.** This section applies to mini-warehouses.

(2) **CLASS OF CONSTRUCTION.** Mini-warehouses shall be of at least type 8, wood frame unprotected construction.

(3) **CONTENTS.** Storage of hazardous materials or vehicles in mini-warehouses is prohibited. The owner shall submit an affidavit to the department stating that the building will not be used for this purpose.

(4) **NUMBER OF EXITS.** (a) Except as provided in par. (b), 2 exits shall be required from each storage compartment.

(b) One exit is permitted from compartments of 3,000 square feet or less.

(5) **TYPE OF EXITS.** (a) Standard exit doors shall be required from compartments with the capacity of 25 persons or more, using the capacity ratios established in s. ILHR 54.05.

(b) Nonstandard exit doors such as overhead, sliding and similar doors may be used for compartments with a capacity of less than 25 persons.

(6) **OPENINGS.** Mini-warehouse buildings on the same property may be located less than 30 feet to each other with no restriction on the percentage of wall openings provided the combined gross area of the buildings, including the area between the buildings, is not more than the area permitted by s. ILHR 54.01.

History: Cr. Register, December, 1978, No. 276, eff. 1-1-79; r. and recr. Register, December, 1981, No. 312, eff. 1-1-82; cr. (6), Register, August, 1985, No. 356, eff. 1-1-86.

ILHR 54.23 Freezer warehouse. History: Cr. Register, December, 1983, No. 336, eff. 1-1-84; r. Register, August, 1985, No. 356, eff. 1-1-86.

Chapter ILHR 55

THEATERS AND ASSEMBLY HALLS

ILHR 55.001	Scope (p. 203)	ILHR 55.24	Automatic smoke outlet (p. 212)
ILHR 55.01	Definitions (p. 203)	ILHR 55.25	Stage vestibules (p. 212)
ILHR 55.02	Class of construction (p. 204)	ILHR 55.26	Footlight trough (p. 212)
ILHR 55.03	Height above grade (p. 205)	ILHR 55.27	Fireproof paint (p. 212)
ILHR 55.04	Exposure and courts (p. 206)	ILHR 55.28	Stage accessory rooms (p. 212)
ILHR 55.05	Separation from other occupancies (p. 206)	ILHR 55.29	Isolation of hazards (p. 212)
ILHR 55.06	Capacity (p. 207)	ILHR 55.30	Lights and lighting (p. 213)
ILHR 55.07	Number and location of exits (p. 208)	ILHR 55.32	Sanitary facilities (p. 213)
ILHR 55.08	Type of exits (p. 208)	ILHR 55.33	Standpipes (p. 214)
ILHR 55.09	Stairways (p. 208)	ILHR 55.34	Fire extinguishers (p. 214)
ILHR 55.10	Exit doorways and doors (p. 209)	ILHR 55.39	Use of "safety-base" film (p. 215)
ILHR 55.11	Exit lights (p. 209)	ILHR 55.40	Motion picture machine booths, general (p. 215)
ILHR 55.12	Required exit width (p. 209)	ILHR 55.41	Construction of booth (p. 215)
ILHR 55.13	Seating (p. 210)	ILHR 55.42	Doors (p. 215)
ILHR 55.14	Width of aisles (p. 210)	ILHR 55.43	Openings (p. 215)
ILHR 55.15	Lobbies and foyers (p. 210)	ILHR 55.44	Ventilation of booths (p. 216)
ILHR 55.16	Inclines and aisle steps (p. 210)	ILHR 55.45	Relief outlets (p. 216)
ILHR 55.17	Obstruction (p. 210)	ILHR 55.46	Electric wiring (p. 216)
ILHR 55.18	Mirrors and false openings (p. 210)	ILHR 55.47	Motion picture machine (p. 216)
ILHR 55.19	Decorations (p. 211)	ILHR 55.48	Fire protection in booth; care and use of film (p. 216)
ILHR 55.20	Elevator and vent shafts (p. 211)	ILHR 55.49	Portable booths (p. 217)
ILHR 55.21	Stage separation (p. 211)	ILHR 55.50	Maintenance (p. 217)
ILHR 55.22	Proscenium wall (p. 211)		
ILHR 55.23	Proscenium curtain (p. 211)		

Note: Chapter Ind 55 was renumbered to be chapter ILHR 55 effective January 1, 1984.

ILHR 55.001 Scope. The requirements of this chapter shall apply to all theatres and assembly halls.

Note: For assembly areas in connection with schools and other places of instruction, refer to ch. ILHR 56.

History: 1-2-56; r. and recr. Register, August, 1985, No. 356, eff. 1-1-86.

ILHR 55.01 Definitions. In this chapter:

(1) "Assembly halls" or "places of assembly" mean all buildings, or parts of buildings, other than theaters, which will accommodate more than 100 persons for entertainment, recreation, worship or dining purposes.

Note: Assembly halls or places of assembly which will accommodate not more than 100 persons are included within the scope of ch. ILHR 54.

(2) "Theaters" means all buildings or parts of buildings, containing an assembly hall, having a stage which may be equipped with curtains or permanent or movable scenery, or which is otherwise adaptable to the showing of plays, operas, motion pictures or similar forms of entertainment.

History: 1-2-56; am. (1) (intro. par.), Register, March, 1972, No. 195, eff. 4-1-72; am. (1)(a), Register, January, 1980, No. 289, eff. 2-1-80; r. and recr. Register, August, 1985, No. 356, eff. 1-1-86.

ILHR 55.02 Class of construction. (1) **GENERAL.** The capacities of buildings or parts of buildings in this classification for the various types of construction shall not exceed, and shall comply with, the following requirements:

MAXIMUM CAPACITIES

Class of Construction	Without Complete Automatic Fire Sprinkler System Protection		With Complete Automatic Fire Sprinkler System Protection	
	With Stage	Without Stage	With Stage	Without Stage
Type 1 and 2	No limit	No limit	No limit	No limit
Type 3 and 4	750	1,500	1,000	2,000
Type 5 and 6	500	1,000	750	1,500
Type 7 and 8	300	750	500	1,000

(2) **UNLIMITED CAPACITY BUILDINGS.** (a) Except as provided in par. (b), one story buildings of Types No. 5 or 6 non-combustible construction may have unlimited capacity provided the building has no ground floors or basement floors. Heavy timber columns, roof framing and roof decking may be substituted for required non-combustible columns, roof framing and roof decking. Mezzanine floors and supports shall be not less than one-hour non-combustible construction.

(b) A basement, or ground floor mechanical equipment room may be provided if separated from the upper level by not less than 4-hour non-combustible construction.

(2m) **TYPE 7 AND 8 CONSTRUCTION.** (See s. ILHR 51.03.) Where buildings of these classifications are erected of type 7 or 8 construction, the following restrictions shall apply:

(a) Located at least 20 feet from any other building or adjoining property line.

(b) Is not built in connection with a building used for any other purpose.

(c) Except as provided in subds. 1. to 5., not more than one story in height and limited to one floor level.

1. *Exception.* A basement or ground floor heating and fuel room enclosed with fire-resistive construction as specified in s. ILHR 55.29, with all interior openings protected with self-closing fire-resistive door assemblies as specified in s. ILHR 51.047 will be permitted.

2. *Exception.* Places of worship are permitted to have a full basement or ground floor and a balcony having an occupant load of not more than 30 persons.

3. *Exception.* One-story and ground-floor assembly halls of type 7 or 8 construction will be permitted providing the following conditions are satisfied:

a. Both levels shall exit directly to grade. One exit stair from the lower level up to the exit discharge grade is permitted providing the stair is enclosed to the outside by 2-hour fire-resistive rated construction;

b. The ground story exterior walls shall be of masonry or concrete;

c. The lower level shall be separated from the upper level by 2-hour noncombustible fire-resistive rated construction or better. The first floor supports shall also be of 2-hour noncombustible fire-resistive rated construction;

d. All stairways shall be enclosed by at least 2-hour fire-resistive rated enclosures;

e. The maximum capacity of the building is limited as specified in sub. (1); and

f. All other requirements of ch. ILHR 55 are satisfied.

4. *Exception.* Additions to existing buildings of type 7 or 8 construction having a basement or second floor, or both, will be permitted under the scope of ch. ILHR 54 providing the following conditions are satisfied:

a. The building contains no other occupancy except the owner's private residence;

b. Public occupancy is prohibited in the basement and second floor;

c. The addition does not contain a basement, second floor or ground floor;

d. The public occupancy areas are divided by partitions, dividers and similar objects into definable areas having a maximum capacity of 100 occupants each. Each definable area shall have 2 independent, remote exits to the outside;

e. The maximum capacity of the building is limited as specified in sub. (1);

f. All other requirements of ch. ILHR 54 are satisfied; and

g. This exception does not apply to buildings originally constructed within 5 years of submissions of plans for the addition.

5. *Exception.* Buildings completely protected by automatic fire sprinkler system protection may not exceed 2 stories in height and shall be limited to 2 floor levels.

(3) **BALCONIES ACCOMMODATING MORE THAN 100.** In any theater or assembly hall, balconies which accommodate more than 100 persons shall be type 1 or 2 construction as specified in s. ILHR 51.03.

History: 1-2-56;(1); (1) (a); (2); (2) (a); (2) (b); (2) (c); (2) (d); (2) (e); (2) (f); (3); am. Register, June, 1956; No. 6, eff. 7-1-56; am. (1) (a), Register, August, 1957, No. 20, eff. 9-1-57; am. Register, January, 1961, No. 61, eff. 2-1-61; am. (2) (a), Register, February, 1971, No. 182, eff. 7-1-71; r. and recr. (2) (a) eff. 8-1-71 and exp. 1-1-72; cr. (2) (a) eff. 1-1-72, Register, July, 1971, No. 187; r. and recr. (1), am. (2) intro. par., and (3), Register, June, 1972, No. 198, eff. 1-1-73; cr. (1) (a), Register, September, 1973, No. 213, eff. 10-1-73; am. (2) (a), Register, May, 1974, No. 221, eff. 6-1-74; am. (1) (a), Register, July, 1974, No. 223, eff. 8-1-74; r. (2) (d) and (e), Register, December, 1977, No. 264, eff. 1-1-78; am. (1) (a), cr. (2) (a) 1. to 3., Register, December, 1978, No. 276, eff. 1-1-79; am. (2) (a) 2.e., Register, January, 1980, No. 289, eff. 2-1-80; am. (2) (a) 3. c., Register, December, 1981, No. 312, eff. 1-1-82; reprinted to correct error in (2) (a) 1., Register, February, 1982, No. 314; renum. (2) (a) 1. to 3., (b) and (c) to be (2) (c) 2. to 4., (a) and (b), r. (2) (a) (intro.) and cr. (2) (c) (intro.) and 1., Register, August, 1985, No. 356, eff. 1-1-86; emerg. r. and recr. (1) and (2) (a) and (b), am. (2) (c) (intro.), 3. e. and 4. e., cr. (2) (c) 5., eff. 9-6-86; r. and recr. (1) renum. (2) to be (2m) and am. (c) (intro.), 3. e. and 4. e., cr. (c) 5., Register, November, 1986, No. 371, eff. 12-1-86; reprinted to restore dropped copy, Register, December, 1986, No. 372.

ILHR 55.03 Height above grade. (1) **THEATERS.** The height of the sills of the principal entrance doors to any theater, as defined in s. ILHR 55.001, shall be not more than 18 inches above the outside grade at that point. The floor level at the highest row of seats on the main floor shall not be more than 6 feet above the outside grade at the main entrance; the floor level at the lowest row of seats on the main floor shall be not more than 6 feet below, or above, the grade at the nearest exit.

(2) **ASSEMBLY HALLS AND ROOF GARDENS ABOVE FIRST STORY.** Where assembly halls are provided above the first story, the following limitation of occupancy, type of construction and exit facilities shall apply:

Type of Construction	Maximum No. of Occupants	Height Above Grade
Type 1 and 2	No limit	See s. ILHR 51.03†
Type 3 thru 6	400	2nd story
Type 3 thru 6	200	3rd and 4th story

† One smokeproof stair tower from the level of the assembly hall leading directly to the exterior at street grade shall be provided for every 750 persons capacity, or fraction thereof. These stairways shall be at least 44 inches wide and shall be in addition to other required stairways in the building.

(3) **BASEMENT ASSEMBLY HALL.** An assembly hall may be placed in the basement of a type 1 or 2 building if the capacity does not exceed 2,500 persons, or in the basement of a building of type 3 through 6 construction if the capacity does not exceed 400 persons.

History: 1-2-56; r. and recr. Register, September, 1959, No. 45, eff. 10-1-59; am. (2) and (3), Register, June, 1972, No. 198, eff. 1-1-73; am. (2), Register, September, 1973, No. 213, eff. 10-1-73.

ILHR 55.04 Exposure and courts. (1) Every theater or assembly hall which accommodates more than 600 persons shall have at least 3 walls abutting on streets, alleys, or open courts.

(2) The wall containing the main entrance to any theater or assembly hall shall abut on a street. The lobby or passageway leading from the main entrance doors to the foyer or auditorium shall be direct and unobstructed and of a minimum width equal to the sum of the widths of the main entrance doors. There shall be no openings from other occupancies to such a corridor or passageway.

(3) The width of every exit court shall be at least 6 feet for an occupancy not exceeding 500 persons, and shall be increased at the rate of one foot per each 500 persons additional. Every such court shall lead to a public thoroughfare, either directly, or through a passageway of equal width, not less than 8 feet high enclosed with unpierced 4-hour fire-resistive walls, ceiling and floor as specified in s. ILHR 51.04. The floor and ceiling shall be designed for a live load of not less than 150 pounds per square foot. No such court, or passageway shall be used for storage or any other purpose whatsoever.

History: 1-2-56; am. (3), Register, February, 1971, No. 182, eff. 7-1-71; r. and recr. (3) eff. 8-1-71 and exp. 1-1-72; cr. (3) eff. 1-1-72, Register, July, 1971, No. 187.

ILHR 55.05 Separation from other occupancies. (1) Every theater and assembly hall shall be separated from any other occupancy by an absolute occupancy separation as specified in s. ILHR 51.08, except that a special occupancy separation as specified in s. ILHR 51.08 may be used
Register, December, 1986, No. 372

(4) An occupancy separation is not required between a church and a day school operated by the church, providing the building complies with the requirements of chs. ILHR 55 and 56. Where these 2 chapters differ, the more stringent requirement shall apply.

(5) Every theater and assembly hall shall be separated from a storage garage or a repair garage as specified in s. ILHR 59.22.

History: 1-2-56; am. Register, January, 1961, No. 61, eff. 2-1-61; am. (3), Register, February, 1971, No. 182, eff. 7-1-71; r. and recr. (3) eff. 8-1-71 and exp. 1-1-72; cr. (3) eff. 1-1-72, Register, July, 1971, No. 187; am. (2), Register, June, 1972, No. 198, eff. 1-1-73; cr. (4), Register, December, 1978, No. 276, eff. 1-1-79; am. (1) and (3), cr. (5), Register, December, 1981, No. 312, eff. 1-1-82.

ILHR 55.06 Capacity. (1) The following table includes various types of occupancy within the scope of this section, together with the method to be used in determining the capacity.

(2) No greater number of persons than the number thus established shall be permitted in any theater or assembly hall.

Use or Occupancy	Basis of Capacity
(a) Arenas and field houses.....	4 sq. ft. per person. Use seated areas only.
(b) Assembly halls, with stage.....	7 sq. ft. per person.
(c) Banquet halls	10 sq. ft. per person.
(d) Churches (auditoriums).....	7 sq. ft. per person.
(e) Churches(dining rooms)	10 sq. ft. per person.
(f) Dance halls.....	10 sq. ft. per person.
(g) Dining rooms.....	10 sq. ft. per person.
(h) Gymnasiums	6 sq. ft. per person for seated space. 15 sq. ft. per person for unseated space.
(i) Lecture halls.....	7 sq. ft. per person.
(j) Lodge halls.....	6 sq. ft. per person for seated space. 15 sq. ft. per person for unseated space.
(k) Skating rinks	45 sq. ft. per person.
(l) Theaters	7 sq. ft. per person.
(m) Theater lobbies.....	7 sq. ft. per person.

(3) The capacity of theaters and theater lobbies must be combined to determine the theater capacity.

(4) (a) Every theater or assembly hall having movable seats shall display a sign stating the maximum number of persons permitted by code.

1. The sign shall be placed in a conspicuous place at the main entrance to each theater or assembly hall.

2. The sign shall have the following wording: "Limit (Number) Persons." The maximum number of persons shall be determined by the capacity as permitted by sub. (2) and s. ILHR 55.12. The lettering shall be

white on a dark background. The letters shall be not less than 1½ inches in height and the number shall be not less than 3 inches in height.

History: 1-2-56; cr. (4) (a), Register, July, 1966, No. 127, eff. 8-1-66; r. (2) (k), renum. (2) (l) (m) (n) to be (k) (l) and (m), Register, September, 1973, No. 213, eff. 10-1-73; am. (2)(k), Register, December, 1981, No. 312, eff. 1-1-82.

FP ILHR 55.07 Number and location of exits. (1) (a) Except as provided in par. (b), every floor and balcony of a theater and assembly hall shall be provided with not less than 2 exits, placed as far apart as practicable and so located that if any exit is blocked, some other exit will still be available from every part.

(b) A balcony accommodating not more than 30 persons in places of worship may be served by one exit.

(2) Where more than 600 persons are accommodated, there shall be at least 3 exits and where more than 1,000 persons are accommodated, there shall be at least 4 exits.

(3) Exits shall be distributed on all sides which adjoin streets, alleys or open courts.

History: 1-2-56; r. and recr. (1), Register, August, 1985, No. 356, eff. 1-1-86.

FP ILHR 55.08 Type of exits. (1) The required exits from any part of a theater or assembly hall shall be exit doorways, stairways or ramps.

(2) All exits to grade from a higher or lower level shall be stairways or approved ramps. In all theaters and in assembly halls having a capacity of more than 400 persons, where the exit rise is not more than 3 feet approved ramps shall be used. By approved ramp is meant an incline located inside the building and having a slope of not more than one foot of rise in 8 feet.

(3) Stairway exits shall be interior stairways, or smokeproof towers as specified in s. ILHR 51.17; except that "B" type fire escapes may be used as exits from balconies for not more than one-half the required exit width, if located against blank walls.

FP ILHR 55.09 Stairways. (1) Every stairway in a theater or assembly hall shall be enclosed as specified in s. ILHR 51.18 with the following exceptions:

(a) Monumental stairways from the main floor to the first balcony need not be enclosed provided the balcony is served by additional enclosed stairways as specified in ss. ILHR 51.02 (11) and 55.07.

(b) 1. In a place of worship, a monumental exit access stairway from the main floor to the first balcony having an occupant load of not more than 30 persons need not be enclosed.

2. In a place of worship, a monumental exit access stairway from the main floor to the first balcony having an occupant load of 31 to 100 persons need not be enclosed provided the balcony is served by an additional open stairway.

3. In a place of worship, stairways from the main floor to the first balcony having an occupant load greater than 100 persons shall be enclosed to the outside as specified in ss. ILHR 51.02 (11) and 51.18.

Register, August, 1985, No. 356

4. Stairways from the basement to the first floor of a single story place of worship need not be enclosed if they lead directly to the exits.

(2) Stairways and steps which have more than 3 risers shall have hand-rails on both sides.

(3) (a) Every stairway used by the public in a theater or assembly hall shall have a uniform rise of not more than 7½ inches and a uniform tread of not less than 10 inches, measuring from tread to tread and from riser to riser.

(b) Less than 3 risers may be used to elevated altars, podiums and similar areas in churches provided the elevated area is not part of a required exit passageway.

Note. See s. ILHR 51.16 for general stairway requirements.

History: 1-2-56; am. Register, January, 1961, No. 61, eff. 2-1-61; r. and recr. Register, February, 1968, No. 146, eff. 3-1-68; am. (4), Register, February, 1971, No. 182, eff. 7-1-71; am. (2), Register, December, 1974, No. 228, eff. 1-1-75; am. (1) (intro.) and cr. (4) (a), Register, December, 1978, No. 276, eff. 1-1-79; am. (1) (a), Register, December, 1981, No. 312, eff. 1-1-82; r. and recr. (1) (b), Register, October, 1982, No. 322, eff. 11-1-82; r. (2), renum. (3) and (4) to be (2) and (3) and am. (3) Register, August, 1985, No. 356, eff. 1-1-86.

ILHR 55.10 Exit doorways and doors. (1) Every required single exit doorway shall contain a standard exit door as specified in s. ILHR 51.15. For double doors, with or without mullions, the width of each door may be reduced to 2 feet 6 inches. **FP**

(2) No single door or leaf of a double door, shall be more than 3 feet 6 inches wide, and no 2 doors shall be hinged together.

(3) No rolling, sliding or revolving door shall be counted as an exit from any theater or assembly hall, nor shall any such door be permitted where it would be liable to be used by the public as an exit.

(4) Sills at all exit doorways shall be level and flush with adjacent inside and outside floors and ramps. Where an aisle or passageway leads to an exit from either side of the exit doorway there shall be a level floor space at the doorway extending the width of the aisle and the doorway.

History: 1-2-56; am. (4), Register, August, 1985, No. 356, eff. 1-1-86.

ILHR 55.11 Exit lights. All required exits, except those in church auditoriums, shall be identified by an approved exit light. Directional exit lights shall be provided to direct occupants to the exits. Exit lights and directional exit lights shall be as specified in s. ILHR 51.15 (5). **FP**

History: 1-2-56; r. and recr. Register, December, 1983, No. 336, eff. 1-1-84.

ILHR 55.12 Required exit width. (1) The total required exit width from a building level shall be in accordance with the requirements of ss. ILHR 51.15 (6) and 51.16(3). **FP**

(2) In theaters, the width of the front entrance shall be not less than ¼ of the total required exit width.

History: 1-2-56; am. (1), Register, June, 1972, No. 198, eff. 1-1-73; am. (1), Register, December, 1974, No. 228, eff. 1-1-75.

ILHR 55.13 Seating. All chairs, seats and benches used for the purpose of assembly seating shall conform to the requirements of subch. V, Assembly Seating Facilities, of ch. ILHR 62.

History: 1-2-56; am. Register, January, 1961, No. 61, eff. 2-1-61; r. (2), renum. (3) to (6) to be (2) to (5), Register, January, 1980, No. 289, eff. 2-1-80; r. and recr., Register, December, 1981, No. 312, eff. 1-1-82.

FP ILHR 55.14 Width of aisles. (1) Aisles having seats on both sides shall not be less than 2 feet 10 inches wide at the beginning and shall increase in width toward the exits at the rate of $\frac{1}{4}$ inch per foot of run; or the aisle may have a uniform width not less than the average width of the foregoing calculation. No wall aisle shall be less than 3 feet wide and no other straight aisle shall be less than 3 feet 6 inches wide.

(2) There shall be a cross aisle leading to each required side exit. Cross aisles shall not be less than 6 feet 8 inches back to back of adjacent rows of seats.

FP ILHR 55.15 Lobbies and foyers. The width of lobbies and foyers shall be determined on the same basis as required for exits in s. ILHR 55.12, but shall in no case be less than 5 feet wide, and shall be so designed and apportioned as to prevent congestion and confusion. Lobbies and foyers which serve as means of egress shall be at least equal in combined width to the required width of the stairways, passageways, aisles or exit doorways leading to them.

ILHR 55.16 Inclines and aisle steps. (1) To overcome any difference in level between courts, corridors, lobbies, passageways or aisles required, or used, in egress from a theater or an assembly hall, approved ramps as specified in s. ILHR 55.08 shall be employed where the difference in elevation does not exceed 3 feet, except that this requirement need not apply to balconies.

(2) Steps in balcony aisles shall extend the full width of the aisle and shall have a uniform rise and run as specified in s. ILHR 55.09. No handrails will be required.

FP ILHR 55.17 Obstruction. (1) All lobbies, aisles, passageways and doorways shall be kept free from furniture, drapes, display equipment, merchandise, vending machines and other obstructions, and no person except an employe shall be allowed to stand in or occupy, any of the aisles, passageways, corridors or lobbies during any performance or public gathering. Except that patrons may be allowed to wait in a lobby or similar space if such use does not encroach upon the required clear width of the exits. Such waiting shall be restricted to areas separated from the required exit ways by fixed railings not less than 42 inches high. In entrance lobbies only, the exit space may be divided by railings not less than 36 inches high set up in the direction of travel in an approved manner for the regulation of ingress and egress.

(2) A booth or counter for the sale of package merchandise may be placed in the lobby or foyer of a theater where there is sufficient excess space so that the front of the booth or counter can be located not less than 5 feet back of the line marking the width of the lobby or foyer required for exit purposes.

ILHR 55.18 Mirrors and false openings. (1) No mirror shall be placed in any part of a theater or assembly hall used by the public for exit purposes. Register, August, 1985, No. 356

poses, including lobbies, corridors, stairways, ramps or any other exit facility. Where a mirror is used in an auditorium, it shall be placed flush with the wall and with the bottom at least 7 feet above any floor, balcony, gallery or platform.

(2) No false opening or decorative device giving the appearance of a door or window, where none exists, shall be placed in any part of a theater or assembly hall used by the public.

ILHR 55.19 Decorations. Fabric decorations used in theaters and assembly halls shall be flame proof.

ILHR 55.20 Elevator and vent shafts. Enclosures for elevator and vent shafts shall be of 2-hour fire-resistive construction as specified in s. ILHR 51.04 and all openings therein protected by fire-resistive doors or windows as specified in s. ILHR 51.047.

History: 1-2-56; am. Register, February, 1971, No. 182, eff. 7-1-71; r. and recr. eff. 8-1-71 and exp. 1-1-72; cr. eff. 1-1-72, Register, July, 1971, No. 187.

ILHR 55.21 Stage separation. (1) In every theater and assembly hall the stage shall be completely separated from the auditorium by a proscenium wall of 4-hour fire-resistive construction as specified in s. ILHR 51.04, except as follows:

(a) In theaters and assembly halls having a capacity not exceeding 500 persons, the proscenium wall shall be of 2-hour fire-resistive construction as specified in s. ILHR 51.04, or better.

(b) In theaters and assembly halls an open stage or platform will be permitted without the proscenium wall separation from the auditorium, provided the stage or platform is not more than 6 feet higher or wider than the proscenium opening.

History: 1-2-56; am. (1) intro par., and (1) (a), Register, February, 1971, No. 182, eff. 7-1-71; r. and recr. (1) intro. para. and (a), eff. 8-1-71 and exp. 1-1-72, and cr. (1) intro. par. and (a), eff. 1-1-72, Register, July, 1971, No. 187.

ILHR 55.22 Proscenium wall. (1) The proscenium wall shall extend from an incombustible foundation, or from the lowest fireproof floor below the stage floor, to the highest adjoining roof, except that where a 4-hour fire-resistive wall is required it shall extend at least 2 feet above the highest adjoining roof.

(2) There shall be not more than 2 openings in the proscenium wall below the level of the auditorium floor, and not more than 2 openings other than the proscenium opening, in the proscenium wall above the level of the auditorium floor, except that in addition to the above openings there may be one opening to provide access through the proscenium wall to the orchestra pit.

(3) Each such opening shall be protected by fire-resistive door assemblies as specified in s. ILHR 51.047. **FP**

History: 1-2-56; am. (3), Register, March, 1972, No. 195, eff. 4-1-72; am. (3), Register, August, 1985, No. 356, eff. 1-1-86.

ILHR 55.23 Proscenium curtain. Where a proscenium wall is required for the separation of a stage from an auditorium, the proscenium opening shall be provided with a curtain as approved by the department.

History: 1-2-56; r. and recr. Register, May, 1971, No. 185, eff. 6-1-71.

FP ILHR 55.24 Automatic smoke outlet. Where a fireproof proscenium curtain is required, or provided, the stage shall be provided with one or more automatic smoke outlets, constructed of metal or other incombustible material, placed near the center and above the highest part of the stage, and having a combined area equal to not less than 8% of the area of the stage floor. Vertical louver openings shall be placed not less than 3 feet above the roof and shall be not less than twice the area of the shaft. The smoke outlet shall be designed and constructed so as to open by gravity, and so as to effectively overcome the effects of neglect, rust, dirt, frost, snow, heat, twisting, or warping of the frame work. The louvers, or dampers in the openings shall be held closed by cotton or hemp cords running to the stage floor close to each stage door. Fusible links, or other approved heat release devices, shall be inserted in each cord near the outlets.

ILHR 55.25 Stage vestibules. All entrances to the stage shall be vestibuled in such manner as to protect the curtain, scenery, and auditorium from drafts of air.

ILHR 55.26 Footlight trough. The footlight trough shall be made of, or lined with, incombustible material.

ILHR 55.27 Fireproof paint. All stage scenery, properties, curtains, and decorations made of combustible material, and all woodwork in or about the stage, shall be effectively flame-proofed.

ILHR 55.28 Stage accessory rooms. (1) All dressing rooms, property rooms, and other storage or workrooms shall be built of incombustible material throughout, and shall be separated from the stage by a special occupancy separation as specified in s. ILHR 51.08.

(2) No dressing room or employees' room shall be placed more than one story below the grade line, and no dressing room shall be placed above or below the auditorium unless separated therefrom by a special occupancy separation as specified in s. ILHR 51.08.

FP ILHR 55.29 Isolation of hazards. (1) **GENERAL.** (a) Except as provided in par. (b), all fuel-fired heating boilers and furnaces, fuel rooms and breeching, storage vaults for paints, oils and similar combustibles, and other similar hazards in a building shall be enclosed with 3-hour fire-resistive construction as specified in s. ILHR 51.04, except that in case of an assembly hall accommodating not more than 300 persons, an enclosure of 2-hour fire-resistive construction, as specified in s. ILHR 51.04, may be used.

(b) Direct vent sealed combustion chamber appliances and suspended heating equipment as specified in Table 64.21 need not be enclosed with fire-resistive rated construction as specified in par. (a).

(2) **PROTECTION OF OPENINGS.** All openings shall be protected by fire-rated door assemblies equipped with self-closing devices as specified in s. ILHR 51.047.

(3) **WATER HEATING APPLIANCES.** All appliances used for heating water which are fired with solid fuel, liquid fuel or gas shall be located in a boiler or furnace room except that gas-fired booster water heaters used exclu-

sively for sanitizing dishes and cooking utensils need not be installed in a fire-resistive enclosure.

History: 1-2-56; r. and recr. (2), Register, August, 1957, No. 20, eff. 9-1-57; am. (1), Register, September, 1959, No. 46, eff. 10-1-59; am. (1), Register, February, 1971, No. 182, eff. 7-1-71; r. and recr. (1), eff. 8-1-71, and exp. 1-1-72; cr. (1) eff. 1-1-72, Register, July, 1971, No. 187; am. (1), Register, January, 1980, No. 289, eff. 2-1-80; r. and recr., Register, December, 1981, No. 312, eff. 1-1-82; am. (1), Register, August, 1985, No. 356, eff. 1-1-86.

ILHR 55.30 Lights and lighting. (1) Electric lights shall be used for lighting where electric current is available. No oil lamps or other open lights shall be used in or about any stage containing scenery.

(2) No gas lighting of any kind shall be used on any stage containing scenery, nor in any property room, storage room, scene dock, or fly gallery, except in localities where electricity is not available.

(3) In all theaters and assembly halls, all stairways, passageways, and exit doors shall be properly lighted and shall remain lighted throughout every performance or entertainment and until the audience has left the building.

ILHR 55.32 Sanitary facilities. (1) **TOILET ROOMS.** All occupancies included under the scope of this chapter shall be provided with separate toilet rooms for each sex. Separate toilet rooms for the employees and the general public need not be provided if the toilet rooms are accessible to both the employees and the general public.

(a) *Toilet rooms in connection with stage.* In theaters and assembly halls which are equipped for the showing of stage productions, separate toilet rooms for each sex, furnished with at least one water closet and one lavatory, shall be provided in connection with the stage.

(b) *Toilet room in connection with motion picture booth.* In theaters where motion picture machines are run continuously for a period of more than 2 hours without at least 10 minutes intermission for the motion picture machine operator for each 2-hour period, a toilet room, furnished with one water closet and one lavatory, shall be provided in direct connection with the motion picture booth.

(2) **SANITARY FIXTURES.** The number of water closets, urinals, lavatories and drinking facilities required for the total number of occupants of each sex shall be determined in accordance with the ratios established in Table 55.32, but in no case shall the ratio of the number of fixtures to number of employees be less than those specified in Table 54.12-B. The total number of persons will be considered equally divided between men and women unless a different ratio is established.

TABLE 55.32
NUMBER OF FIXTURES REQUIRED FOR PLACES OF ASSEMBLY

Type of Occupancy	Type of Fixture				
	Water Closets (WC)		Urinals (U)	Lavatories (L)	Drinking Facilities (DF)
	Males (M)	Females (F)	Males (M)		
Places of assembly					
0-100 persons of each sex	1	1	0	One (L) for each 2 required	One (DF) for each 150 persons up to 600
101-200 persons of each sex	1	2	1		
201-300 persons of each sex	1	3	2		
301-400 persons of each sex	2	4	2		
401-500 persons of each sex	2	5	3		
501-600 persons of each sex	2	6	4		
Over 600 persons of each sex	One (WC) for each additional 600 (M), or fraction	One (WC) for each additional 276 (F), or fraction	One (U) for each additional 500 (M), or fraction	(WC) or (U), or both, or fraction	One additional (DF) for each additional 3000 persons
Taverns and restaurants ¹	One (WC) for each 75 (M), or fraction	One (WC) for each 30 (F), or fraction	One (U) ² for each 50 (M), or fraction		0

¹The ratio of the number of fixtures to the number of persons accommodated in excess of 300 need be one-half of the figures shown.

²Urinal may be omitted in restaurants which accommodate less than 25 males and do not serve alcoholic beverages.

Note: See also rules of the department of health and social services for sanitary fixtures for public swimming places, mobile home parks, camping grounds, camping resorts, recreational camps and educational camps.

History: 1-2-56; r. and recr. Register, December, 1976, No. 252, eff. 1-1-77; am. (2), Register, December, 1977, No. 264, eff. 1-1-78; am. (2), Register, December, 1978, No. 276, eff. 1-1-79; am. (2), Register, December, 1981, No. 312, eff. 1-1-82; am. table, Register, August, 1985, No. 356, eff. 1-1-86.

FP ILHR 55.33 Standpipes. (1) **FIRE DEPARTMENT STANDPIPES.** Fire department standpipes shall be provided in all buildings exceeding 60 feet in height.

(2) **STANDPIPES.** Dry standpipes shall be provided in all buildings, except churches and places of worship, having theaters and assembly halls with an occupancy load of more than 750 persons, unless an approved automatic sprinkler system is installed. First-aid standpipes shall be provided on the stage of every theater and assembly hall where a proscenium curtain is required.

History: 1-2-56; r. and recr. Register, December, 1976, No. 252, eff. 1-1-77; am. (2), Register, December, 1978, No. 276, eff. 1-1-79; emerg. r. and recr. (2), eff. 9-6-86; r. and recr. (2), Register, November, 1986, No. 371, eff. 12-1-86.

FP ILHR 55.34 *Fire extinguishers. Portable fire extinguishers shall be provided and maintained as specified in s. ILHR 51.22.

History: 1-2-56; r. and recr., Register, December, 1981, No. 312, eff. 1-1-82.

*See Appendix A for further explanatory material.

DEPT. OF INDUSTRY, LABOR & HUMAN RELATIONS 215
Theaters, assembly halls ILHR 55

ILHR 55.35 Automatic sprinklers. History: 1-2-56; r. Register, June, 1983, No. 330, eff. 7-1-83.

Note: See s. ILHR 52.015 for requirements pertaining to automatic fire sprinkler systems.

ILHR 55.39 Use of "safety-base" film. (1) The requirements of ss. ILHR 55.40 through 55.49 will not apply in buildings in which movie projectors are used with "safety-base" film provided the conditions of pars. (a) and (b) are met.

(a) The owner shall submit an affidavit to the department stating that "safety-base" film only will be used in all movie projectors.

(b) The affidavit shall be signed by the owner and the signature notarized.

Note: For definition of "owner," see s. 101.01 (2) (i), Stats.

History: Cr. Register, April, 1971, No. 184, eff. 5-1-71.

ILHR 55.40 Motion picture machine booths, general. Every motion picture machine using nitro-cellulose film, together with all auxiliary and associated equipment, shall be enclosed in a booth so arranged as to permit the operator to walk freely on either side and in back of the machine. At least 48 square feet in area shall be provided for one machine, and 24 square feet additional for each machine over one. The ceiling height shall be not less than 7 feet.

ILHR 55.41 Construction of booth. The floor of each motion picture booth shall be constructed of masonry or reinforced concrete, or shall be covered with not less than 2 inches of fire-resistive material. The walls and ceilings shall be not less than 2-hour fire-resistive construction as specified in s. ILHR 51.04.

History: 1-2-56; am. Register, February, 1971, No. 182, eff. 7-1-71; r. and recr. eff. 8-1-71 and exp. 1-1-72; cr. eff. 1-1-72, Register, July, 1971, No. 187.

ILHR 55.42 Doors. (1) The door to the booth shall be not larger than necessary for the safe and proper use and maintenance of the booth and equipment, but in no case shall its dimensions be smaller than 2 feet by 5 feet or larger than 3 feet by 7 feet. The top of the door shall be not less than 12 inches below the ceiling of the booth.

(2) The door shall be a tight-fitting self-closing fire door as specified in s. ILHR 51.047, shall open outwardly, and shall not be equipped with any latch.

History: 1-2-56; am. (2), Register, February, 1971, No. 182, eff. 7-1-71; r. and recr. (2) eff. 8-1-71 and exp. 1-1-72; cr. (2) eff. 1-1-72, Register, July, 1971, No. 187.

ILHR 55.43 Openings. (1) Two openings for each motion picture machine may be provided. The one for the operator's view shall not be larger than 200 square inches and the one for projection not larger than 120 square inches. Where separate stereopticon, spot, or floodlight machines are installed, not more than one opening shall be provided for each such machine for both the operator's view and the projection of light. All such openings shall be as small as practicable. FP

(2) Each opening shall be provided with an approved gravity shutter set into guides not less than one inch at sides and bottom, and overlapping the top of the opening by at least one inch when closed. Shutters shall be not less than No. 10 U.S. Standard gauge iron or equivalent, arranged to move freely in guides of like material and thickness bolted to

the wall. Each shutter shall be suspended by a cord and shall be so arranged that closing is by gravity action. A fusible link shall be provided in the cord over each shutter. A link shall also be provided over each magazine, which on operating will close all shutters. A manual release shall be provided near each exit door by which all shutters can be closed simultaneously. Shutters shall not be blocked open nor held open in any manner except by the harness of cords and links as herein described.

ILHR 55.44 Ventilation of booths. Every booth or room housing projection, sound or any other equipment which vitiates good air conditions or requires the attention of an attendant shall be ventilated as required by s. ILHR 64.05. Fresh air intakes in booth walls, except for outside air, shall not exceed 72 square inches in area, nor be more than 3 inches above the floor. They shall be equipped with automatic shutters as described for projection openings.

History: 1-2-56; r. and recr. Register, October, 1967, No. 142, eff. 11-1-67; am. Register, December, 1975, No. 240, eff. 1-1-76.

FP ILHR 55.45 Relief outlets. Every booth or room housing projection, sound or other equipment which constitutes a fire, smoke, explosion or fuming hazard shall be equipped with one or more gravity outlets extending upward from the ceiling through the roof. The net area of such gravity relief outlets shall be equal to one per cent of the room or booth floor area, but not less than 12 inches in diameter. Such outlets shall be constructed as sheet metal ducts having double walls with $\frac{1}{2}$ inch air space between, or better construction. Where a relief outlet passes through, or is within 18 inches of any combustible construction, or passes through any other occupancy, approved masonry flues as specified for chimneys, s. ILHR 64.46, shall be used. The relief outlets shall be equipped, at the booth or room outlets, with a gravity shutter which will open automatically under excessive heat conditions. The automatic shutter shall normally be tightly closed where mechanical exhaust ventilation is required in the same room.

FP ILHR 55.46 Electric wiring. All lights and electric wiring, also motors, arc lamps, rheostats, and associated electrical equipment shall conform in type and arrangement to the requirements of the Wisconsin state electrical code, vol. 2, ch. ILHR 16.

ILHR 55.47 Motion picture machine. Every projection machine shall be securely fastened to the floor, and together with sound head and other associated equipment, shall be of safe design. No part of the film shall be outside of a tight metal enclosure during projection, and the feed and take-up reels shall have riveted, flanged, or welded joints. A shutter shall be placed in front of the condenser, arranged so as to be closed except when held open by the operator, or by some mechanical device which will assure immediate closure when operation of the machine is stopped.

ILHR 55.48 Fire protection in booth; care and use of film. (1) All shelves, furniture and fixtures shall be incombustible. No combustible material shall be permitted to be within such booth, except films and film cement not exceeding one pint. Smoking is prohibited. Heating equipment in booths shall be limited to steam, warm air, hot water or electric convection heaters with low surface temperature elements. Radiators shall be protected by $\frac{1}{4}$ inch mesh screen with the top sloped at least 45° to the horizontal.

(2) Films not in process of rewinding, examination or projection shall be kept in metal containers. Up to 40 pounds of film may be kept in the projection booth in interstate commerce commission shipping containers. Excess over 40 pounds shall be kept in an approved film cabinet, but the total quantity of film in any booth shall not exceed 125 pounds.

(3) Rewinding in the projection booth is prohibited unless done in an approved enclosed type rewind machine. An approved can with self-closing hinged cover shall be provided for scrap film.

(4) Up to 125 pounds of film in addition to that permitted in a projection booth, may be kept in containers as specified above, providing this excess is in a rewind room of not less than 80 square feet area, and of the construction specified in ss. ILHR 55.41 and 55.42. Such room shall have a vent of at least 50 square inches in area extending upward to the outside of the building, with a clearance to combustible material conforming to s. ILHR 55.45. Furniture and heating shall be as for the projection booth, and smoking is prohibited.

Note: The weight of a 1000 foot roll of 35 millimeter film is assumed as 5 pounds.

ILHR 55.49 Portable booths. (1) Every portable booth used to confine the fire hazards of a motion picture machine shall be of approved design conforming to the requirements for permanent booths.

(2) Every booth used for more than 3 consecutive performances in one location will be considered a permanent booth.

ILHR 55.50 Maintenance. All theaters and assembly halls, and all parts thereof, shall be kept clean, sanitary and in good repair. **FP**

Chapter ILHR 56

SCHOOLS AND OTHER PLACES OF INSTRUCTION

Subchapter I — General Requirements		ILHR 56.42	General (p. 227)
ILHR 56.001	Scope (p. 219)	ILHR 56.43	Exit doors and exit lights (p. 227)
ILHR 56.01	Maximum height (p. 219)	ILHR 56.44	Barrier-free requirements (p. 227)
ILHR 56.02	Classes of construction (p. 219)	ILHR 56.45	Sanitary fixtures (p. 228)
ILHR 56.03	Protection of basement levels (p. 220)	ILHR 56.46	Fire alarms (p. 228)
ILHR 56.05	Exterior wall openings (p. 221)	Subchapter IV — Life-Safety Requirements for Existing Schools	
ILHR 56.06	Exits (p. 221)	ILHR 56.50	Scope (p. 228)
ILHR 56.07	Required exit width (p. 223)	ILHR 56.51	Purpose (p. 228)
ILHR 56.08	Exit doors (p. 224)	ILHR 56.52	Definitions (p. 228)
ILHR 56.09	Passageways (p. 224)	ILHR 56.53	Schools constructed prior to 1930 (p. 228-1)
ILHR 56.13	Assembly seating (p. 224)	ILHR 56.54	Schools constructed between January 1, 1930, and January 1, 1950 (p. 228-1)
ILHR 56.14	Seats, desks and aisles (p. 224)	ILHR 56.56	Extension of time for compliance (p. 228-1)
ILHR 56.15	Isolation of hazards (p. 224)	ILHR 56.57	Failure to comply (p. 228-2)
ILHR 56.16	Sanitary facilities (p. 225)	ILHR 56.58	Life-safety evaluation procedures (p. 228-3)
ILHR 56.17	Lighting (p. 225)	ILHR 56.59	Plan of school (p. 228-3)
ILHR 56.18	Fire extinguishers (p. 226)	ILHR 56.60	Plans and specifications (p. 228-4)
ILHR 56.19	Fire alarms (p. 226)	ILHR 56.61	Approval of alternate life-safety plan (p. 228-4)
ILHR 56.20	Standpipes (p. 226)	ILHR 56.62	Re-evaluation (p. 228-4)
Subchapter II — Relocatable Classrooms		ILHR 56.63	Life-safety standards (p. 228-5)
ILHR 56.30	Scope (p. 226)	ILHR 56.64	Stairway smoke-enclosure (p. 228-9)
ILHR 56.31	Definitions (p. 226)	ILHR 56.65	Stairway smoke cut-offs (p. 228-10)
ILHR 56.32	General (p. 226)	ILHR 56.66	Horizontal separations (p. 228-10)
ILHR 56.33	Anchoring requirements (p. 226)		
ILHR 56.34	Exit doors and exit lights (p. 226-1)		
ILHR 56.35	Class of construction separations (p. 227)		
ILHR 56.36	Barrier-free requirements (p. 227)		
ILHR 56.37	Sanitary fixtures (p. 227)		
ILHR 56.38	Fire alarms (p. 227)		
Subchapter III — Mobile Training Classrooms			
ILHR 56.40	Scope (p. 227)		
ILHR 56.41	Definitions (p. 227)		

Note: Chapter Ind 56 was renumbered to be ch. ILHR 56, effective January 1, 1984. Sections ILHR 56.50 to 56.57 were created on emergency rules effective 7-3-89. Sections ILHR 56.60 to 56.70 were created as emergency rules effective 9-6-89.

Subchapter I — General Requirements

ILHR 56.001 Scope. The requirements of this chapter shall apply to all public and private schools, universities, colleges, academies, seminaries, libraries, museums and art galleries; including all buildings or parts of buildings used primarily for instructional purposes.

Note: Section 101.02 (15) (a), Stats., exempts rural school buildings from the provisions of this code. See s. ILHR 51.01 (114b) for definition of a rural school building.

History: 1-2-56; am. Register, May, 1971, No. 185, eff. 6-1-71; am. Register, December, 1977, No. 264, eff. 1-1-78; am. Register, January, 1980, No. 289, eff. 2-1-80.

ILHR 56.01 Maximum height. (1) Buildings occupied primarily by pupils up to and including grade 12 shall not exceed 4 stories or 48 feet in height.

(a) *Exception.* Buildings provided with complete automatic sprinkler or automatic smoke detection systems, occupied primarily by students of grades 9 through 12, shall be no more than 6 stories or 72 feet in height.

Note: Also see requirements for classes of construction.

History: 1-2-56; r. Register, May, 1971, No. 185, eff. 6-1-71; cr. Register, September, 1973, No. 213, eff. 10-1-73.

ILHR 56.02 Classes of construction. (1) Except as provided in sub. (4), every building not more than one story in height may be of type 7 or 8 construction as specified in s. ILHR 51.03.

(2) Except as provided in sub. (4), every 2-story building shall be not less than type 6 construction as specified in s. ILHR 51.03 with the exception that all floors and their supports shall be at least noncombustible one-hour fire-resistive rating.

(3) Except as provided in sub. (4), every building 3 or more stories in height shall be of type 1 or 2 construction as specified in s. ILHR 51.03.

(4) The story heights specified in subs. (1) to (3) may be increased by one story in buildings completely protected by automatic fire sprinkler system protection.

(5) Auditoriums, gymnasiums or field houses, or those parts of buildings similarly used, shall comply with the following:

(a) Limitations when occupancy is restricted to first story or ground floor only.

MAXIMUM CAPACITIES

Class of Construction	Without Complete Automatic Fire Sprinkler System Protection		With Complete Automatic Fire Sprinkler System Protection	
	With Stage	Without Stage	With Stage	Without Stage
Type 1 and 2	No limit	No limit	No limit	No limit
Type 3 and 4	750	1,500	1,000	2,000
Type 5 and 6	500	1,000	750	1,500
Type 7 and 8	300	750	500	1,000

(b) 1. Except as provided in subd. 2., one story building of Types No. 5 or 6 non-combustible construction may have unlimited capacity provided the building has no ground floors or basement floors. Heavy timber columns, roof framing and roof decking may be substituted for required non-combustible columns, roof framing and roof decking. Mezzanine floors and supports shall be not less than one-hour non-combustible construction.

2. A basement or ground floor mechanical equipment room may be provided if separated from the upper level by not less than 4-hour non-combustible construction.

History: 1-2-56; r. and recr. Register, May, 1971, No. 185, eff. 6-1-71; am. (1) and (2) and r. and recr. (3), Register, June, 1972, No. 198, eff. 1-1-73; cr. (4), Register, September, 1973, No. 213, eff. 10-1-73; r. and recr. (4) (a) 1., Register, May, 1974, No. 221, eff. 6-1-74; am. (4) (a) 1., Register, December, 1978, No. 276, eff. 1-1-79; emerg. am. (1) to (3), renum. (4) to (5) and r. and recr. (5) (a) and (b), cr. (4), eff. 9-6-86; am. (1) to (3), renum. (4) to (5) and r. and recr. (5) (a) and (b), cr. (4), Register, November, 1986, No. 371, eff. 12-1-86.

ILHR 56.03 Protection of basement levels. (1) **GENERAL REQUIREMENT.** Buildings with basements shall at such levels be protected with an ap-
Register, April, 1990, No. 412

proved automatic sprinkler system as specified in s. ILHR 51.23 or an approved automatic smoke detection system, as specified in s. ILHR 51.245, either of which shall be electrically connected to the required fire alarm system.

Note: See s. ILHR 51.245 for additional requirements pertaining to smoke detectors.

Note: See ss. ILHR 52.012 (1) and 52.02 for additional requirements pertaining to basements.

(2) **RETROACTIVITY.** Existing buildings which do not conform to the requirements specified in sub. (1) on or after the effective date of this subsection shall comply with the following:

Next page is numbered 221

(a) The corridors in the basement shall be protected by an approved smoke detection system.

(b) Such systems shall be installed in accordance with NFPA No. 72E-1978, Standard on Automatic Fire Detectors or NFPA No. 74-1980, Household Fire Warning Equipment, but in no case shall smoke detectors be spaced more than 30 feet apart on center or more than 15 feet from any wall.

Note: See s. ILHR 51.01 for definitions of "automatic" and "basement".

History: Cr. Register, January, 1980, No. 289, eff. 2-1-80; cr. (2), eff. 1-1-83, am. (1), Register, December, 1981, No. 312, eff. 1-1-82.

ILHR 56.05 Exterior wall openings. (1) **ONE-STORY BUILDINGS.** One-story buildings with no floor levels below the first floor need not be provided with exterior wall openings other than required exits.

(2) **MULTI-STORY BUILDINGS.** (a) Except as provided in par. (b), buildings more than one story shall be provided with fire department access openings as specified in s. ILHR 52.02 (2).

(b) Fire department access openings are not required provided the building is protected throughout by an automatic fire sprinkler system and that system is connected to the required fire alarm system.

History: 1-2-56; am. Register, January, 1961, No. 61, eff. 2-1-61; r. and recr., Register, May, 1971, No. 185, eff. 6-1-71; r. and recr., Register, September, 1973, No. 213, eff. 10-1-73; r. (2) and renum. (3) to be (2), Register, January, 1980, No. 289, eff. 2-1-80; r. and recr. Register, June, 1983, No. 330, eff. 7-1-83.

ILHR 56.06 Exits. (1) **TOTAL NUMBER OF EXITS.** The total number of exits from each floor level and each building shall be determined on the basis of total aggregate exit width and distances to exit. Each building and each floor level shall be provided with at least 2 exits.

(2) **TYPE OF EXITS.** At least 2 exits from all floor levels shall lead directly to grade through standard exit doors, stairs, interior enclosed stairs, smokeproof stair towers, fire-rated exit corridors, passageways, or ramps. One-half of the remaining required exits may be horizontal exits or fire escapes. Fire escapes are prohibited as required exits in pre-school, elementary, middle, and high schools. In no case will fire escapes be permitted above the second story.

(a) *Standard exit doors.* Standard exit doors shall be provided in accordance with the requirements of ss. ILHR 51.16 and 56.08.

(b) *Exit stairs.* Stairs shall conform to the requirements of s. ILHR 51.16, except that the stairs shall have a uniform rise of not more than 7½ inches, measured from tread to tread, and a uniform tread of not less than 10 inches, measured from nosing to nosing of tread. Handrails shall be provided on both sides. All stairs serving basements shall be in accordance with the requirements of s. ILHR 51.02 (11). No closets or rooms may be placed under a stairway or landing.

(c) *Interior enclosed stairs and smokeproof stair towers.* Interior stairs and smokeproof stair towers shall be constructed in accordance with the requirements of ss. ILHR 51.17 and 51.18.

(d) *Fire-rated exit corridors.* All rated exit corridors required to satisfy limitations on exit distance shall be of not less than one-hour fire-resis-

tive construction, unless the fire-resistive ratings indicated in Table 51.03-A for required exit corridor enclosures are more restrictive.

(e) *Exit ramps.* The minimum width of exit ramps shall be determined in accordance with the requirements of s. ILHR 56.07. The minimum width shall be not less than 3 feet 8 inches. Exit ramps, other than those required for the physically disabled, shall have a slope not exceeding 1:8. Ramp slopes exceeding 1:12 shall be provided with handrails. Ramps shall be provided with a slip-resistant finish. Ramps shall be provided from areas noted under sub. (3) (c) involving a change of elevation between floor levels or platforms not exceeding 3 feet.

(f) *Fire escapes.* Fire escapes shall be constructed in accordance with the requirements of s. ILHR 51.20.

(g) *Horizontal exits.* Horizontal exits shall be constructed in accordance with the requirements of s. ILHR 51.19 and shall be of at least 4-hour rated construction.

(3) LOCATION OF EXITS. (a) *Exit distance.* 1. Travel distance to an exterior exit door, a required fire-resistive rated exit corridor, interior enclosed stairs, smokeproof stair tower, horizontal exit, or fire escape, from any point in a building accessible to the public, shall not exceed 150 feet.

2. Where an approved automatic fire sprinkler system is provided throughout the building, an increase in exit distance to 200 feet will be permitted.

3. Building service areas, including pipe chases and tunnels, catwalks, ducts or similar spaces not accessible to the public, shall not exceed 300 feet from an exit.

(b) *Distribution of exits.* All exits shall be distributed to provide the best possible means of egress. The exits shall be located so that in case any exit is blocked at any point some other exit is accessible through public passageways at all times. Locked security gates and doors shall not be placed so as to block required exit passageways or create dead-end corridors.

(c) *Auditorium, gymnasium and field house exits.* This rule shall apply only to auditoriums, gymnasiums and field houses which have a capacity exceeding 600 persons. One-half of the required exits shall discharge directly to a street, alley or open court connected with a street, unless a 2-hour rated exit corridor is provided, wide enough to accommodate one-half of the occupants, which extends from the interior wall of the auditorium, gymnasium or field house to an exterior exit. The remaining required exits shall discharge directly to the exterior or to a public passageway which permits 2 directions of travel to the exits at the exterior of the building. The exiting shall be direct and unobstructed.

(4) CLASSROOM EXITS. (a) *Exits serving 50 persons or less.* At least one exit shall be provided from all rooms serving a capacity of 50 persons or less. The exit shall discharge directly to the exterior of the building or to a public passageway which permits 2 directions of travel to the exterior.

(b) *Exits serving 51-100 persons.* At least 2 exits shall be provided from all rooms serving a capacity of 51-100 persons. One exit shall discharge directly to the exterior of the building or to a public passageway which permits 2 directions of travel to the exterior. One exit may discharge

through an adjacent room provided a clear passageway is maintained from the connecting door to a required exit serving the adjacent room.

(c) *Exits serving more than 100 persons.* At least 2 exits shall be provided from all rooms serving a capacity of more than 100 persons. The exits shall discharge directly to grade or to a public passageway which permits 2 directions of travel to the exterior.

(5) **WIDTH OF EXITS.** The total required exit width shall be provided in accordance with the requirements of s. ILHR 56.07.

(6) **EXIT LIGHTS.** All required exits indicated in s. ILHR 56.06 (2), and FP exits from areas serving a capacity of more than 100 persons, shall be identified by an approved exit light. Directional exit lights shall be provided to direct occupants to an exit. Exit lights and directional exit lights shall be as specified in s. ILHR 51.15 (5).

History: 1-2-56; am. (1), cr. (1) (a), Register, September, 1959, No. 45, eff. 10-1-59; am. Register, January, 1961, No. 61, eff. 2-1-61; r. and recr. (1) (a), renun. (2) to be (3), (3) to be (4), (4) to be (5), (5) to be (6) and (6) to be (7), and cr. (2) and (8), Register, May, 1971, No. 185, eff. 6-1-71; r. and recr., Register, September, 1973, No. 213, eff. 10-1-73; am. (1) (a) 2., Register, December, 1974, No. 228, eff. 1-1-75, r. and recr. Register, December, 1975, No. 240, eff. 1-1-76; am. (2), intro. and cr. (2) (g), Register, December, 1976, No. 252, eff. 1-1-77; am. (6), Register, December, 1983, No. 336, eff. 1-1-84; emerg. am. (3) (a), eff. 9-6-86; am. (3) (a), Register, November, 1986, No. 371, eff. 12-1-86.

ILHR 56.07 Required exit width. (1) The total required exit width from FP a building level shall be in accordance with the requirements of ss. ILHR 51.15 (6) and 51.16 (3).

(2) The capacity of educational buildings or any individual story or section thereof for the purpose of determining exits shall be the maximum capacity designated on approved plans.

(a) The maximum capacity shall not exceed the requirements of par. (b).

(b) The maximum capacities of all rooms and spaces as listed below shall be determined on the basis of the minimum net square feet area per person shown for that occupancy unless otherwise designated on the plans.

	Minimum Square Feet Per Occupant
1. Academic classrooms—Regular.....	20
2. Administrative and office space.....	75
3. Arts, crafts, drafting.....	30
4. Bleachers (one seat per 18 inches of bench length)	
5. Gymnasiums, field houses, auditoriums, theatres, lecture rooms (fixed seating).....	6
6. Gymnasiums, field houses, multipurpose rooms, cafeterias, study halls, commons and other level floor areas with nonfixed individual seating.....	10
7. Home economics, business education.....	30
8. Industrial arts-vocational shop.....	50
9. Laboratories-Science (fixed lab. tables).....	30
10. Libraries and resource centers.....	20
11. Museums and art galleries.....	40
12. Music	
a. Vocal.....	10
b. Instrumental.....	20
13. Special education	
a. Mentally retarded, physically handicapped, etc.....	35

History: 1-2-56; r. and recr. (3), Register, May, 1971, No. 185, eff. 6-1-71; am. (1), Register, June, 1972, No. 198, eff. 1-1-73; r. and recr., Register, September, 1973, No. 213, eff. 10-1-73;

Register, November, 1986, No. 371

r. and recr. (1), r. (2), (3) and (4), renum. (5) to be (2), Register, December, 1974, No. 228, eff. 1-1-75.

ILHR 56.08 Exit doors. (1) **STANDARD EXIT DOORS.** Exit doors shall comply with the requirements of s. ILHR 51.15. The aggregate width of exit doors shall be as required in s. ILHR 56.07. No single door or leaf of a double door shall be more than 42 inches wide.

(2) **CLASSROOM EXIT DOOR WIDTH AND SWING.** (a) *Classroom doors serving 50 persons or less.* Classroom doors serving classrooms with a capacity of 50 persons or less shall be not less than 3 feet 0 inches in width. The doors may swing into the classroom.

(b) *Classroom doors serving more than 50 persons.* Classroom doors serving classrooms with a capacity of more than 50 persons shall be standard exit doors and shall swing outward toward the means of egress.

(3) **ALL OTHER EXIT DOORS.** Doors serving areas other than classrooms shall comply with s. ILHR 54.06.

History: 1-2-56; r. and recr. Register, December, 1975, No. 240, eff. 1-1-76; am. (2) and cr. (3), Register, December, 1978, No. 276, eff. 1-1-79; am. (1) and (2) (b), r. (2) (c), Register, January, 1980, No. 289, eff. 2-1-80.

FP ILHR 56.09 Passageways. (1) The minimum unobstructed width of corridors and passageways which are used by the public or by the occupants generally, shall be determined in the same manner as specified for stairways in s. ILHR 56.07, but in no case shall this width be less than 4 feet. Corridors and passageways serving as a means of egress shall be at least equal in combined width to the required width of the stairways or passageways leading to them.

History: 1-2-56; r. (1) and renum. (2) to be (1), Register, May, 1971, No. 185, eff. 6-1-71.

ILHR 56.13 Assembly seating. All assembly seating in auditoriums, gymnasiums, field houses and other large group occupancy areas shall comply with the requirements of subch. V, Assembly Seating Facilities, of ch. ILHR 62. Where any area of a building in this category has a stage loft in excess of 25 feet 0 inches in height above the stage floor and is equipped with permanent or movable scenery, it shall comply with ss. ILHR 55.21 through 55.30.

History: 1-2-56; r. and recr., Register, May, 1971, No. 185, eff. 6-1-71; r. and recr., Register, December, 1981, No. 312, eff. 1-1-82.

ILHR 56.14 Seats, desks and aisles. (1) Seats, desks, tables and other loose equipment need not be fastened to the floor or to each other provided that any seating arrangement use, will maintain during occupancy, free and unobstructed intermediate, cross and wall aisles leading to the exit.

(a) Stepped floors or tiered platforms shall be no less than 48 inches in width to permit the above arrangement.

(b) Seats, desks, tables and other loose equipment used in instructional occupancies shall be of a durable type of construction to assure safety and stability.

History: 1-2-56; r. and recr., Register, May, 1971, No. 185, eff. 6-1-71.

FP ILHR 56.15 Isolation of hazards. (1) **GENERAL.** Except for direct vent sealed combustion chamber appliances and suspended heating equipment, Register, November, 1986, No. 371

ment as specified in Table 64.21, all fuel-fired heating boilers and furnaces, power boilers, fuel rooms, and breeching, storage vaults for paints, oils and similar combustibles, fuel-fired kilns and dryers, and other similar hazards, shall be enclosed as follows:

(a) In every building more than one story in height, the enclosure shall be not less than 4-hour fire-resistive rated construction as specified in s. ILHR 51.04.

(b) In one-story buildings, the enclosure shall be not less than 2-hour fire-resistive rated construction as specified in s. ILHR 51.04.

(2) **PROTECTION OF OPENINGS.** All openings shall be protected by fire-rated door assemblies equipped with self-closing devices as specified in s. ILHR 51.047.

History: 1-2-56; am. Register, February, 1971, No. 182, eff. 7-1-71; r. and recr. eff. 8-1-71 and exp. 1-1-72; cr. eff. 1-1-72, Register, July, 1971, No. 187; r. and recr., Register, January, 1980, No. 289, eff. 2-1-80; am. (1) (intro.), Register, December, 1981, No. 312, eff. 1-1-82; am. (1) (intro.), Register, August, 1985, No. 356, eff. 1-1-86.

ILHR 56.16 Sanitary facilities. (1) **TOILET ROOMS.** Separate toilet rooms for each sex shall be provided for all occupancies included under the scope of this chapter. The toilet rooms shall be completely enclosed and arranged to ensure privacy, except that in elementary schools (kindergarten through grade 8) the doors to the toilet rooms may be eliminated if the entrance to the toilet room is located in the wall of a public corridor.

(2) **SANITARY FIXTURES.** The following tabulated groups or combinations thereof shall be provided with one fixture of each type in accordance with the ratio given in chart to serve the total number of persons designated on the plans.

Type of Fixture	K-6	7-12	Post High School	Large Group Occupancy Areas	Administrative Areas
Water Closets (F).....	95	50	100	200	10
Water Closets (M).....	75	100	200	300	15
Urinals.....	35	50	100	150	40
Lavatories.....	75	100	100	150	15
Drinking Fountains.....	1 per 6,000 sq. ft. floor area or 1 per floor or both				

(a) When fixtures required for a designated group are not available to another designated group the number of fixtures shall be provided according to the ratio indicated in the chart and independent of other group requirements.

(b) Where a theatre is a part of an educational facility the requirements listed under "large group occupancies" shall apply.

History: 1-2-56; am. (2), (3), (4) and (4) (a), Register, September, 1959, No. 45, eff. 10-1-59, r. and recr. (4), intro. par., Register, December, 1967, No. 144, eff. 1-1-68; r. and recr. Register, May 1971, No. 185, eff. 6-1-71; am. (1) (intro.), r. and recr. (1) (a), cr. (1) (b), Register, September, 1973, No. 213, eff. 10-1-73; renum. (1) to be (2) and cr. (1), Register, December, 1976, No. 252, eff. 1-1-77.

ILHR 56.17 Lighting. (1) **ELECTRIC LIGHTING.** Every class, study or recreation room shall be equipped with sufficient electrical lighting units to maintain the illumination required in ch. Ind 19, Illumination Code.

(2) **GENERAL.** All other rooms and spaces in school buildings shall be equipped with means for supplying electric illumination in the quantity required for the purpose for which the room or space is used. All electrical work shall be installed to conform to the requirements of the Wisconsin state electrical code, vol. 2, ch. ILHR 16.

History: 1-2-56; am. Register, January, 1961, No. 61, eff. 2-1-61; cr. (3), Register, November, 1963, No. 95, eff. 12-1-63; am. (3) (c), Register, February, 1971, No. 182, eff. 7-1-71; r. and recr. Register, May, 1971, No. 185, eff. 6-1-71.

FP ILHR 56.18* Fire extinguishers. Portable fire extinguishers shall be provided and maintained as specified in s. ILHR 51.22.

History: 1-2-56; am. Register, May, 1971, No. 185, eff. 6-1-71; am. Register, December, 1976, No. 252, eff. 1-1-77; r. and recr., Register, December, 1981, No. 312, eff. 1-1-82.

FP ILHR 56.19 Fire alarms. Every building shall be provided with a proper alarm system complying with s. ILHR 51.24.

History: 1-2-56; am. Register, May, 1971, No. 185, eff. 6-1-71.

FP ILHR 56.20 Standpipes. (1) **FIRE DEPARTMENT STANDPIPES.** Fire department standpipes shall be provided in all buildings exceeding 60 feet in height.

(2) **DRY STANDPIPES.** Dry standpipes shall be provided in all buildings 3 stories or more in height, unless an approved automatic fire sprinkler system is installed.

Note: See s. ILHR 52.015 for requirements pertaining to automatic sprinkler systems for museums, art galleries and libraries.

History: Cr. Register, December, 1976, No. 252, eff. 1-1-77; emerg. r. and recr. (2), eff. 9-6-86; r. and recr. (2), Register, November, 1986, No. 371, eff. 12-1-86.

Subchapter II—Relocatable Classrooms

ILHR 56.30 Scope. This part provides the minimum requirements for the design and construction of relocatable classrooms as defined in s. ILHR 56.31.

History: Cr. Register, December, 1978, No. 276, eff. 1-1-79.

ILHR 56.31 Definitions. "Relocatable classrooms" mean mobile home type structures located on permanent foundations and equipped and used for educational instruction.

History: Cr. Register, December, 1978, No. 276, eff. 1-1-79.

ILHR 56.32 General. Relocatable classrooms shall comply with the applicable sections of this code except as otherwise specified in this part.

History: Cr. Register, December, 1978, No. 276, eff. 1-1-79.

ILHR 56.33 Anchoring requirements. Provisions acceptable to the department for the prevention of overturning of the relocatable classroom as a result of wind pressure shall be made.

Note: The department accepts provisions such as ground anchors installed in accordance with ANSI standard A 119.1.

History: Cr. Register, December, 1978, No. 276, eff. 1-1-79.

*See Appendix A for further explanatory material.

Register, November, 1986, No. 371

ILHR 56.34 Exit doors and exit lights. (1) EXIT DOORS. Exit doors shall be at least 3 feet 0 inches in width.

(2) **EXIT LIGHTS.** Illuminated exit lights are not required in relocatable classrooms.

History: Cr. Register, December, 1978, No. 276, eff. 1-1-79.

ILHR 56.35 Class of construction separations. Relocatable classrooms connected to another building shall be separated by class of construction separations as specified in s. ILHR 51.02 (20).

History: Cr. Register, December, 1978, No. 276, eff. 1-1-79; am. Register, December, 1983, No. 336, eff. 1-1-84.

ILHR 56.36 Barrier-free requirements. Access to, interior circulation and toilet facilities for the physically disabled need not be provided for the relocatable classroom if the course taught in the relocatable classroom are available in accessible facilities at the same school site.

History: Cr. Register, December, 1978, No. 276, eff. 1-1-79.

ILHR 56.37 Sanitary fixtures. (1) Sanitary fixtures for relocatable classrooms shall be provided in accordance with the requirements of ss. ILHR 52.50 through 52.64 and 56.16.

(a) *Exception.* Sanitary fixtures within the relocatable classroom structure need not be provided if the sanitary fixtures in the main school building are available for use and the relocatable classroom structure is connected to the main school building with an enclosed passageway.

History: Cr. Register, December, 1978, No. 276, eff. 1-1-79.

ILHR 56.38 Fire alarms. Relocatable classroom structures containing more than 2 classrooms or connected to another building shall be provided with a fire alarm system as specified in s. ILHR 51.24.

History: Cr. Register, December, 1978, No. 276, eff. 1-1-79.

Subchapter III — Mobile Training Units

ILHR 56.40 Scope. This part provides the minimum requirements for mobile training units as defined in s. ILHR 56.41.

History: Cr. Register, December, 1978, No. 276, eff. 1-1-79.

ILHR 56.41 Definitions. "Mobile training units" mean trailer type units constructed and left on wheels. Mobile training units are used for education purposes at one site for a period of time no greater than 9 weeks per year.

History: Cr. Register, December, 1978, No. 276, eff. 1-1-79.

ILHR 56.42 General. Mobile training units shall comply with the applicable sections of this code except as otherwise specified in this part.

History: Cr. Register, December, 1978, No. 276, eff. 1-1-79.

ILHR 56.43 Exit doors and exit lights. (1) **EXIT DOORS.** Exit doors shall be at least 3 feet 0 inches wide.

(2) **EXIT LIGHTS.** Illuminated exit lights are not required for mobile training units.

History: Cr. Register, December, 1978, No. 276, eff. 1-1-79.

ILHR 56.44 Barrier-free requirements. Access to, interior circulation and toilet facilities for the physically disabled need not be provided for

the mobile training units if the course taught in the mobile training units are available in accessible facilities at the same school site.

History: Cr. Register, December, 1978, No. 276, eff. 1-1-79.

ILHR 56.45 Sanitary fixtures. (1) **GENERAL EXEMPTION.** Sanitary fixtures are not required in the mobile training units provided the sanitary fixtures in the main school building are available for use.

(2) **GENERAL REQUIREMENTS.** Toilet rooms within the mobile training unit shall comply with the requirements of ss. ILHR 52.50 through 52.64 and 56.16.

(a) *Exceptions.* 1. The requirements specified in s. ILHR 52.59 are not applicable provided the toilet room door is equipped with a privacy lock.

2. Accessible toilet facilities for the physically disabled need not be provided if accessible toilet facilities in the main school building are made available.

History: Cr. Register, December, 1978, No. 276, eff. 1-1-79.

ILHR 56.46 Fire alarms. Mobile training units used individually are exempt from the provisions of s. ILHR 56.19.

History: Cr. Register, December, 1978, No. 276, eff. 1-1-79.

Subchapter IV — Life-Safety Requirements for Existing Schools

ILHR 56.50 Scope. The provisions of this subchapter shall apply to all existing buildings and portions of buildings constructed prior to January 1, 1950 which are publicly owned or leased as schools and primarily used for instructional purposes for students up to and including grade 12.

History: Cr. Register, April, 1990, No. 412, eff. 5-1-90.

ILHR 56.51 Purpose. The purpose of this subchapter is to incorporate modern safety requirements in all existing schools constructed prior to January 1, 1950 to improve the life-safety of the occupants in these buildings.

History: Cr. Register, April, 1990, No. 412, eff. 5-1-90.

ILHR 56.52 Definitions. In this subchapter:

(1) "Funding is in place" means approval to fund through board approval, annual meeting approval, referendum or similar term.

(2) "Life-safety plan" means the individual plan developed for a school to improve the life-safety of the school.

(3) "Life-safety standards" means the individual plan developed for a school to improve the life-safety of the school.

(4) "Light-panel frames" means any glazed openings.

(5) "Special department inspection program" means inspections performed by the department to evaluate existing schools in accordance with life-safety standards and to establish an individual life-safety plan for each school.

(6) "Transfer grille" means an opening in a wall or door which permits air to flow from one space to another.

Register, April, 1990, No. 412

(7) "Written determination" means a decision by the department after reviewing plans and specifications or other information.

History: Cr. Register, April, 1990, No. 412, eff. 5-1-90.

ILHR 56.53 Schools constructed prior to 1930. Schools constructed prior to 1930 shall comply with the following requirements:

(1) **PRE-1930 SCHOOLS INSPECTED PRIOR TO JANUARY 1, 1989.** (a) *Codes and standards.* The recommendations specified in the individual life-safety plan for the pre-1930 schools inspected prior to January 1, 1989, shall comply with the standards specified in ss. ILHR 56.63 to 56.66.

(b) *Compliance dates.* 1. Pre-1930 schools inspected prior to January 1, 1989, shall implement on or before August 1, 1990, the recommendations of the written life-safety plan developed by the department through the special department inspection program.

2. The August 1, 1990, compliance date may be extended to those schools where an extension of time for compliance as specified in s. ILHR 56.56 has been granted in writing by the department.

Note: The department issued an emergency rule on pre-1930 schools on July 31, 1989, requiring code violations to be corrected by September 1, 1989, and a written implementation plan on the life-safety plan to be submitted to the department by December 1, 1989. Pre-1930 schools inspected prior to January 1, 1989, were evaluated using the inspection form SBD-8013.

(2) **PRE-1930 SCHOOLS INSPECTED AFTER JANUARY 1, 1989.** (a) *Codes and standards.* Any pre-1930 school inspected after January 1, 1989, shall be evaluated in accordance with ss. ILHR 56.63 to 56.66.

(b) *Compliance dates.* Individual compliance dates to implement the life-safety plan shall be established by the department for each school.

History: Cr. Register, April, 1990, No. 412, eff. 5-1-90.

ILHR 56.54 Schools constructed between January 1, 1930, and January 1, 1950. Schools constructed between January 1, 1930, and January 1, 1950, shall comply with the following requirements:

(1) **CODES AND STANDARDS.** The life-safety standards specified in ss. ILHR 56.63 to 56.66 shall be used to evaluate schools constructed between January 1, 1930, and January 1, 1950.

(2) **COMPLIANCE DATES.** All violations identified through the special department inspection program shall be corrected by September 1, 1991, unless an extension of time for compliance as specified in s. ILHR 56.56 has been granted by the department.

History: Cr. Register, April, 1990, No. 412, eff. 5-1-90.

ILHR 56.56 Extension of time for compliance. A school district may request in writing an extension of time to comply with any code violation or the life-safety plan. Extensions may be granted in accordance with one or more of the following:

(1) **CONSTRUCTION PROBLEMS.** The department may grant a reasonable extension of time in order to permit a school district to:

(a) Prepare plans for construction and issue bids for construction;

Register, April, 1990, No. 412

(b) Complete construction that has been delayed due to availability of materials, weather conditions, or other construction-related problems;

(c) Implement interim approved safety measures to protect the building occupants during the time of extension; or

(d) Obtain written approval of an alternate life-safety plan.

(2) **FUNDING PROBLEMS.** (a) A school district may request a one year extension if the school district is unable to implement the life-safety plan due to inadequate funding.

(b) Requests for extensions indicating the school district is unable to correct the code violations or implement the life-safety plan due to inadequate funds shall be submitted to the department with:

1. A written statement obtained from the department of public instruction stating that the school district is unable to borrow money or to use the school's operating reserve to implement the required life-safety standards;

2. A copy of a written plan submitted to the department of public instruction on how the school district will obtain the funds to complete the life-safety plan; and

3. An alternate life-safety plan identifying the interim measures that will be provided to protect the building occupants. The alternate life-safety plan shall be prepared by a registered engineer or architect.

(3) **EXTENSION TO BUILD NEW SCHOOL OR MAJOR REMODELING.** A school district may request an extension of time to comply with the life-safety plan if a school district has approval to construct a new school or additions, or to do major remodeling in the existing building.

(a) The following criteria shall be submitted to the department for a written determination on the request for extension:

1. Written notification and commitment that the funding is in place and that a new school or addition will be constructed or the existing school will undergo major remodeling; and

2. An alternate life-safety plan identifying the interim measures that will be provided to protect the building occupants. The alternate life-safety plan shall be prepared by a registered engineer or architect.

(b) Plans and specifications for any new construction, addition or major remodeling shall be submitted in accordance with s. ILHR 50.12.

(c) The department may grant a 2 year extension to complete the new construction or remodeling. The department may grant an extension longer than 2 years where the school district provides documentation from the architect or engineer and the contractor that the construction will take longer than 2 years.

History: Cr. Register, April, 1990, No. 412, eff. 5-1-90.

ILHR 56.57 Failure to comply. If the department determines that the rules or any extensions to comply with the rules have not been complied with, the department will notify the state superintendent of public instruction to review the matter under s. 115.33, Stats.

History: Cr. Register, April, 1990, No. 412, eff. 5-1-90.

Register, April, 1990, No. 412

ILHR 56.58 Life-safety evaluation procedures. A life-safety evaluation shall be conducted for each existing school in accordance with the following:

(1) **QUALIFICATIONS OF EVALUATOR.** The initial and follow-up inspection for the life-safety evaluation shall be performed by the department or a registered architect or engineer. School districts utilizing registered architects or engineers to perform the life-safety evaluation shall notify the department in writing.

(2) **STANDARDS FOR EVALUATION.** All life-safety evaluations shall be performed using the standards specified in ss. ILHR 56.63 to 56.66.

(3) **LIFE-SAFETY EVALUATION FORM.** The life-safety evaluation shall be conducted using the life-safety evaluation form which is based on ss. ILHR 56.63 to 56.66.

Note: Life-safety evaluation form (SBD-8259) is available from the Safety and Buildings Division, P.O. Box 7969, Madison, Wisconsin 53707.

(a) **Procedures.** Each school building shall be evaluated to determine compliance with the requirements specified in ss. ILHR 56.63 to 56.66, using the life-safety evaluation form as follows:

1. **Complies.** If the building complies, the evaluator shall check the "complies" column.

2. **Does not comply.** If the building does not comply, the evaluator shall check the "does not comply" column.

3. **Comments.** The evaluator shall specify how the building may be brought into compliance, or if other alternatives approved by the department have been utilized.

4. **Not applicable.** If a code section does not apply, write "NA" in each column.

(b) **Filing of life-safety evaluation form.** After completing the inspection and evaluation, the evaluator shall sign and date the life-safety evaluation form and submit the evaluation form to the department. Where a building does not comply with a specific item, the department shall issue written orders on these items and send notification to the school district.

Note: The evaluations for schools constructed between January 1, 1930, and January 1, 1950, were completed on January 1, 1990.

(4) **INTERIM NOTIFICATION.** On or before August 1, 1990, each school district having schools requiring compliance with life-safety plans shall notify the department in writing of what steps have been or will be taken to implement the life-safety standards.

(5) **CERTIFICATE OF COMPLIANCE.** Upon determination of compliance, the department shall certify in writing that the school complies with the life-safety standards. A copy of the reinspection report certificate shall be sent to the school district and the department of public instruction.

History: Cr. Register, April, 1990, No. 412, eff. 5-1-90.

ILHR 56.59 Plan of school. (1) **FLOOR PLAN.** The school district shall be responsible for preparing a floor plan of each school. The floor plan shall include:

- (a) The size and use of all rooms;
 - (b) Location of all exit doors, exit lights, exit passageways and stairways;
 - (c) Location of toilet facilities; and
 - (d) Location of fire alarm horns and pull-stations.
- (2) **DATES OF CONSTRUCTION.** The plan shall show the construction dates of the building and any additions.

History: Cr. Register, April, 1990, No. 412, eff. 5-1-90.

ILHR 56.60 Plans and specifications. Plans and specifications shall be submitted to the department in accordance with s. ILHR 50.12 for any new construction, additions, changing location of exits, structural alterations, or major alterations. A completion statement shall be filed in accordance with s. ILHR 50.10.

History: Cr. Register, April, 1990, No. 412, eff. 5-1-90.

ILHR 56.61 Approval of alternate life-safety plan. (1) TYPES OF ALTERNATIVES. (a) *Alternatives to smoke enclosures and smoke cut-offs.* Where the building configuration does not permit the installation of physical barriers to separate the stairway from the classroom and corridor areas, other alternatives approved by the department may be used. The alternatives may consist of providing a combination of the following items and shall be approved by the department:

1. Additional smoke detectors complying with NFPA 72E;
2. Smoke ventilation systems;
3. Fire suppression systems complying with s. ILHR 51.23; or other fire suppression systems not specified in s. ILHR 51.23, when approved by the local fire department;
4. Standard exits in addition to the required exits to reduce the required travel distance; or
5. Other alternatives providing an equivalency to the rule.

(b) *Other alternatives.* Alternatives to any other life-safety standard may be used, if an equivalency to the life-safety standard is provided and is approved by the department.

(2) **PLAN APPROVAL.** (a) *Plan submission.* Any alternative to a life-safety requirement shall be submitted to the department as a "Preliminary Design Consultation-Aging Schools" prior to preparing final plans and specifications to implement the life-safety plan.

(b) *Notification.* The department shall make a written determination on the alternate life-safety plan and return it to the school district.

History: Cr. Register, April, 1990, No. 412, eff. 5-1-90.

ILHR 56.62 Re-evaluation. Re-evaluations for all public schools shall be performed every 5 years. This inspection shall be coordinated with the department of public instruction's standard audit inspection. The re-Register, April, 1990, No. 412

evaluation may be performed by the department or a registered architect or engineer.

History: Cr. Register, April, 1990, No. 412, eff. 5-1-90.

ILHR 56.63 Life-safety standards. Each existing school building as specified in this subchapter shall be surveyed and evaluated in accordance with the following minimum life-safety standards:

(1) **MAXIMUM CAPACITIES.** The maximum capacities for classrooms and spaces shall be determined in accordance with the following:

(a) Maximum capacities for auditoriums or gymnasiums shall comply with s. ILHR 56.02 for the class of construction requirements.

(b) Classrooms and other instructional spaces shall comply with the maximum capacities specified in s. ILHR 56.07.

(2) **EXITING.** The minimum exiting requirements shall be determined in accordance with the following:

(a) *Number of exits.* The total number of exits from each floor level and each building shall be determined on the basis of total aggregate exit width and distances to exit. Each building and each floor level shall be provided with at least 2 exits located as remote from each other as practical.

(b) *Type of exits.* At least 2 exits from each floor level shall lead directly to grade through standard exit doors, stairs, interior enclosed stairs, smokeproof stairtowers, fire-rated exit corridors, passageways or ramps. One-half of the remaining exits may be horizontal exits or fire escapes. Fire escapes shall be limited to buildings not more than 2 stories in height except that existing fire escapes may remain.

1. Standard exit doors. Standard exit doors shall be a minimum of 3'-0" in width.

2. Exit stairs. All new constructed stairs shall conform to the requirements of s. ILHR 51.16, except that the stairs shall have a uniform rise of not more than 7½ inches, measured from tread to tread, and a uniform tread of not less than 10 inches, measured from nosing to nosing of tread. Handrails shall be provided on both sides. An outside weather-treated wood stairway may be used as a second exit from a building not more than 2 stories in height.

3. Enclosure of interior stairways. All exit stairways shall be enclosed in accordance with s. ILHR 56.06 (2) (c) or separated from the classroom and corridor area with a stairway smoke-enclosure having a one-hour rating as specified in s. ILHR 56.68.

4. Fire-rated exit corridors. All rated exit corridors required to satisfy limitations on exit distance shall be of not less than one-hour fire-resistive construction, unless the fire-resistive ratings indicated in Table 51.03-A for required exit corridor enclosures are more restrictive.

5. Exit ramps. The minimum width of exit ramps shall be determined in accordance with the requirements of s. ILHR 56.07. The minimum width shall be not less than 3 feet 8 inches. Exit ramps, other than those required for the physically disabled, shall have a slope not exceeding 1:8.

Ramp slopes exceeding 1:12 shall be provided with handrails. Ramps shall be provided with a slip-resistant finish.

6. Fire escapes. Fire escapes shall be constructed in accordance with the requirements of s. ILHR 51.20.

(c) *Travel distance.* 1. Non-sprinklered. Travel distance to an exterior exit door, a required fire-resistive rated exit corridor, interior enclosed stairs, smokeproof stair tower, horizontal exit, or fire escape, from any point in a building accessible to the public, may not exceed 150 feet.

2. Sprinklered. Where an approved automatic fire sprinkler system is provided throughout the building, an increase in the travel distance specified in subd. 1 to 200 feet will be permitted.

(d) *Location of exits.* 1. Distribution. All exits shall be distributed to provide the best possible means of egress. The exits shall be located so that in case any exit is blocked at any point some other exit is accessible through public passageways at all times.

2. Auditoriums and gymnasiums. Exits serving auditoriums and gymnasiums which have a capacity exceeding 600 persons shall comply with s. ILHR 56.06 (3) (c).

(e) *Classroom exiting.* 1. Classrooms with 50 or less persons. At least one exit is required from a classroom or other instructional spaces with a capacity of 50 persons or less, and the exit door shall be 3'-0" wide and may swing into the classroom.

2. Classrooms with 51-100 persons. At least 2 exits are required from classrooms or other instructional spaces with a capacity of 51-100 persons, and the exit doors shall be 3'-0" wide and shall swing toward the means of egress.

3. Classrooms with greater than 100 persons. At least 2 exits shall be provided from all classrooms or other instructional spaces having a capacity of more than 100 persons. The exits shall discharge directly to grade or to a public passageway which permits 2 directions of travel to the exterior. The exit width shall comply with s. ILHR 56.06 and the doors shall swing toward the means of egress.

(f) *Exit width.* The total required exit width shall be provided in accordance with s. ILHR 56.07.

(g) *Storage under stairs.* 1. Combustible construction. Stairways constructed of combustible materials may not have any type of material or equipment stored under the stairs.

2. Noncombustible construction. Stairways constructed of noncombustible material having a 2-hour fire-rating may have storage under the stairways. All openings shall be protected with fire-rated door assemblies as specified in s. ILHR 51.047. A smoke detector shall be provided in each storage room under a stairway and the smoke detector shall activate an alarm audible in a normally occupied area or shall activate the building fire alarm.

(3) **STAIRWAY HANDRAILS AND GUARDRAILS.** Stairway handrails and guardrails shall be provided in accordance with the following:

Register, April, 1990, No. 412

(a) *Handrails.* Handrails shall be not less than 30 inches nor more than 34 inches above the nosing of the treads on stairways or above the surface of ramps, as specified in s. ILHR 51.161.

(b) *Guardrails.* Guardrails shall be provided on the open side of elevated platforms, landings, walks, balconies and mezzanines which are more than 24 inches in height. Guardrails shall not be less than 42 inches in height.

(4) **EXIT SIGNS.** Exit signs shall be provided in accordance with the following:

(a) Illuminated exit signs shall identify all required exits, as specified in s. ILHR 56.06.

(b) Directional exit signs shall be located to direct occupants to the exits.

(5) **CORRIDORS.** (a) *Corridor width.* All public corridors and passageways shall have an unobstructed width of at least 4 feet.

(b) *Dead-end corridors.* 1. Locked security gates and doors may not be placed so as to block required exit passageways or create dead-end corridors.

2. At least two directions of egress shall be provided from every room. Any room may be permitted one direction of egress provided the door setback from two directions of egress is not greater than the corridor width. The total number of persons beyond the two directions of egress may not exceed 50.

(6) **FIRE DETECTION, PROTECTION AND SUPPRESSION.** The manual fire alarm system, basement fire protection and portable fire extinguishers shall comply with the following:

(a) *Manual fire alarm system.* At least one fire alarm pull station shall be provided at each exit on each floor to activate the building fire alarm system. The manual fire alarm system shall be audible throughout the floor level.

(b) *Basement protection.* All basement corridors shall be protected with an automatic smoke detection system.

(c) *Portable fire extinguishers.* Portable fire extinguishers shall be located every 75 feet, or there shall be no more than 11,250 square feet per extinguisher as specified in NFPA 10. The extinguishers shall be charged or filled.

(7) **CONSTRUCTION SEPARATION WALL.** (a) *Openings used as standard exits.* If the opening in a construction separation wall is a required exit, the opening shall be provided with exit doors complying with s. ILHR 51.15 and the doors shall have a 3/4-hour fire-rating as specified in s. ILHR 51.047.

(b) *Existing rolling or sliding fire-doors.* Existing rolling or sliding fire-rated doors held open by a fusible link may remain as is, except as separate smoke detector shall be placed at these door locations. The smoke detector shall not be connected with the rolling or sliding fire-rated doors.

(8) **ISOLATION OF HAZARDS.** (a) *Rating of enclosures.* All fuel-fired heating boilers and furnaces, power boilers, fuel rooms, breeching, storage vaults for paints, oils and similar hazards, fuel-fired kilns and dryers, and other similar hazards shall be enclosed with the following:

1. The enclosures located in one story buildings shall be protected with 2-hour fire-rated construction or equivalent.

2. The enclosures located in buildings greater than one story in height shall be protected with 4-hour fire-rated construction or equivalent.

(b) *Protection of openings.* All openings in these enclosures shall be protected with self-closing doors as specified in s. ILHR 51.047.

(9) **MECHANICAL EQUIPMENT.** The heating and ventilating equipment shall comply with the following:

(a) Outside combustion air shall be provided as specified in s. ILHR 64.09.

(b) Air handling units servicing more than one floor level shall be provided with a smoke detection system capable of detecting products of combustion in the ductwork and a means of shutting down the system or stopping the flow of air upon activation of smoke detectors in the ducts. The smoke detectors shall comply with the following:

1. Smoke detectors approved for duct installation shall be installed at a suitable location in:

a. The main supply duct on the downstream side of the filters to automatically stop the fan; and

b. The return air stream, prior to exhausting from the building or being diluted by outside air, to automatically exhaust the smoke-laden return air or to stop the fan. The smoke detector may be omitted in the return air stream in systems of less than 15,000 cubic feet per minute.

2. Smoke detectors shall be installed in accordance with NFPA 72E. Activation of smoke detectors shall sound an alarm audible in a normally occupied area of the building or shall activate the building fire alarm system.

(10) **STRUCTURAL ANALYSIS.** A structural analysis will be required if any visible defects are found in:

(a) Columns;

(b) Beams and framing;

(c) Floor system;

(d) Roof deck and supports;

(e) Exterior walls; or

(f) Foundation walls.

(11) **ELECTRICAL.** The electrical systems shall be inspected in accordance with the following:

(a) Conductors shall be protected against physical damage;

(b) Working space in front of equipment shall be kept clear;

- (c) Proper overcurrent protection shall be provided; and
- (d) Flexible cords shall be properly used.

History: Cr. Register, April, 1990, No. 412, eff. 5-1-90.

ILHR 56.64 Stairway smoke-enclosure. (1) **WHERE REQUIRED.** (a) Where stairway smoke-enclosures are required, they shall be installed to separate all open stairways from all other areas of the building in order to limit the spread of smoke and fumes into the stairways. Stairways leading to open balconies or mazzanines may remain open.

(b) Where it is impossible to construct a one-hour fire-rated stairway smoke-enclosure to separate the open stairway, the department will consider:

1. Stairway smoke cut-offs as specified in s. ILHR 56.65; or
2. Horizontal separations as specified in s. ILHR 56.66.

(2) **CONSTRUCTION.** (a) *Smoke-enclosure wall.* The wall of the stairway smoke-enclosure shall extend vertically from the finished floor to the underside of a floor/ceiling deck or ceiling/roof deck and extend horizontally from wall-to-wall.

(b) *Rating of smoke-enclosure wall.* The stairway smoke-enclosure wall which is located in a building classified as type 1, 2 or 3 construction in accordance with s. ILHR 51.03 (1) to (3) shall be constructed of at least one-hour noncombustible elements. The stairway smoke-enclosure wall which is located in a building classified as type 4, 5, 6, 7 or 8 in accordance with s. ILHR 51.03 (4) to (8) shall be constructed of material having at least a one-hour fire-resistive rating.

(c) *New and replacement door assemblies in a smoke-enclosure wall.* 1. New and replacement door assemblies in a stairway smoke-enclosure wall shall have a 3/4-hour fire-rating and be self-closing. The frame, hardware, hinges, lock sets and closers shall be listed for use with fire-rated doors by U.L., Factory Mutual or other approved testing laboratories.

2. A fire-rated door shall be self-closing and shall remain closed at all times, unless the door is equipped with an automatic self-closing device activated by products of combustion other than heat, or a self-closing device activated by the building fire alarm system.

(d) *Existing doors and frames located in openings in smoke-enclosure walls.* Any framed opening in an existing wall of a stairway shall be equipped with at least a 3/4-hour rated door and the hardware specified in par. (c). Existing doors, frames and light-panel frames located in the existing stairway enclosure walls may remain as is, provided:

1. The door is solid wood core;
2. The door is equipped with self-closing and latching devices;
3. Any transfer grille located in the door is eliminated and the opening is filled with solid wood that is at least as thick as the door;
4. Any glazing in the door is wired glass;
5. Any glazed transom above the door is wired glass; and

6. The existing frame is metal or solid wood at least 3/4-inch thick.

(e) *Platform.* The stairway smoke-enclosure shall be constructed to provide a platform between the smoke-enclosure and the stairs. The platform shall be at least as wide as the stairway, measured at a right angle to the direction of travel. Every platform shall have a length of at least 3 feet, measured in the direction of travel. The swing of the exit doors may not block the required exit passageway.

(f) *Penetrations.* Any opening around a duct, pipe, conduit or wiring penetrating through a stairway smoke-enclosure wall shall be filled solidly with draft stopping material in accordance with s. ILHR 53.63 (1).

(3) **SMOKE DETECTION.** (a) Where a stairway smoke-enclosure does not provide direct exiting to grade, the passageway connecting the stairway smoke-enclosure to the exterior exit shall be protected with smoke detectors. The detectors shall be located in accordance with NFPA 72E.

(b) The smoke detectors shall activate alarms audible in a normally occupied area of the building or shall activate the building fire alarm system.

History: Cr. Register, April, 1990, No. 412, eff. 5-1-90.

ILHR 56.65 Stairway smoke cut-offs. (1) **WHERE REQUIRED.** Where stairway smoke cut-offs are required, they shall be constructed at all open stairways at the basement level and all other floor levels other than the first or ground floor.

(2) **CONSTRUCTION.** The construction of the stairway smoke cut-off shall comply with s. ILHR 56.64 (2).

(3) **SMOKE DETECTION.** (a) Where stairway smoke cut-offs are provided, at least one smoke detector shall be placed at the head of the open stairway at the uppermost floor level. Additional smoke detectors shall be placed throughout the open corridor leading to the stairway. The smoke detectors shall be located in accordance with NFPA 72E.

(b) The smoke detectors shall activate alarms audible in a normally occupied area of the building or shall activate the building fire alarm system.

History: Cr. Register, April, 1990, No. 412, eff. 5-1-90.

ILHR 56.66 Horizontal separations. (1) **WHERE REQUIRED.** Horizontal separations may be used to subdivide a floor into at least 2 smoke compartments, provided the building is classified as type 6 metal frame unprotected construction in accordance with s. ILHR 51.03 (6) or better construction with noncombustible floors and stairways. Horizontal separations may be used as horizontal exits.

(2) **CONSTRUCTION.** Horizontal separations shall have at least a one-hour fire-resistive rating. Openings in the horizontal separations shall be protected with door or window assemblies having a 3/4-hour fire-resistive rating.

History: Cr. Register, April, 1990, No. 412, eff. 5-1-90.

Chapter ILHR 57

RESIDENTIAL OCCUPANCIES

ILHR 57.001	Scope (p. 229)	ILHR 57.08	Enclosure of interior stairways and shafts (p. 239)
ILHR 57.01	Construction (p. 230)	ILHR 57.09	Passageways (p. 240)
ILHR 57.015	Height of first floor above grade for sheltered facilities for battered women (p. 231)	ILHR 57.10	Illumination of exits and exit signs (p. 240)
ILHR 57.016	Automatic fire sprinkler system protection (p. 231)	ILHR 57.11	Habitable rooms with floors below grade (p. 241)
ILHR 57.02	Allowable height and area (p. 231)	ILHR 57.12	Sanitary facilities (p. 242)
ILHR 57.03	Number and location of exits (p. 237)	ILHR 57.13	Windows (p. 242)
ILHR 57.04	Capacity of buildings and exits (p. 237)	ILHR 57.14	Isolation of hazards (p. 243)
ILHR 57.05	Type of exits (p. 238)	ILHR 57.15	Standpipes (p. 243)
ILHR 57.06	Doors (p. 239)	ILHR 57.16	Smoke detection (p. 243)
ILHR 57.07	Steps, stairs and shafts (p. 239)	ILHR 57.165	Smoke detection for CBRF (p. 244)
		ILHR 57.17	Fire alarms (p. 244-1)
		ILHR 57.18	Fire extinguishers (p. 244-1)
		ILHR 57.19	Rowhouse (p. 244-1)

Note: Chapter Ind 57 as it existed on December 31, 1981 was repealed and a new ch. Ind 57 was created effective 1-1-82, except for s. Ind 57.16 (2) which is effective 1-1-83; chapter Ind 57 was renumbered to be ch. ILHR 57 effective January 1, 1984.

ILHR 57.001 Scope. (1) **GENERAL.** The requirements of this chapter shall apply to all places of abode, including, but not limited to, apartment buildings; garden apartments; rowhouses; townhouses; condominiums; hotels; motels; rooming houses; dormitories; convents; monasteries; homes for the aged; sheltered facilities for battered women, as specified in s. 46.95, Stats., serving more than 20 occupants; community-based residential facilities constructed on or after the effective date of this section and serving 9 or more unrelated adults; and community-based residential facilities located in existing buildings on or after the effective date of this section and serving more than 20 unrelated adults.

Note: See s. ILHR 51.01 (102a) and 51.01 (114a) for the definitions of the terms "places of abode" and "rowhouse", respectively.

(2) **EXEMPTIONS.** The requirements of this chapter shall not apply to the following:

- (a) One- and 2-family dwellings;
- (b) Buildings or motels, tourist courts and similar occupancies having separate buildings containing not more than 2 rental units each;
- (c) Migrant labor camps;
- (d) Health care facilities;
- (e) Places of detention;
- (f) Community-based residential facilities constructed on or after the effective date of this section and serving 3 to 8 unrelated adults;
- (g) Community-based residential facilities, serving 9 to 20 unrelated adults, located in existing buildings as specified in ss. ILHR 61.001 (1) and 61.01 (7); and

(h) Sheltered facilities for battered women, as specified in s. 46.95, Stats., serving 20 or less occupants as specified in s. ILHR 61.001 (3).

(i) Bed and breakfast establishments as defined in s. ILHR 51.01 (11a).

Note 1: See chs. ILHR 20-25, Uniform Dwelling Code for requirements regarding one- and two-family dwellings. The requirements of chs. ILHR 20-25 also apply to newly constructed community-based residential facilities serving 3 to 8 unrelated adults.

Note 2: See ch. Ind 201, for requirements regarding migrant labor camps.

History: Cr. Register, December, 1981, No. 312, eff. 1-1-82; am. Register, October, 1982, No. 322, eff. 11-1-82; am. (1), Register, December, 1983, No. 336, eff. 1-1-84; cr. (2) (i), Register, August, 1985, No. 356, eff. 1-1-86.

ILHR 57.01 Construction. (1) **GENERAL.** For the purpose of determining the maximum height and area of buildings and structures within the scope of this chapter, the building construction shall be classified in accordance with the construction standards as specified in s. ILHR 51.03.

Note: See ss. HSS 3.40-3.65, Wis. Adm. Code, for additional construction requirements pertaining to community-based residential facilities.

(2) **LIVING UNIT SEPARATION.** (a) Each living unit, except rowhouse units as specified in s. ILHR 51.01 (114a), shall be separated from other living units, common use areas and from the exit access corridors by construction protected with at least the equivalent of one layer of 5/8-inch Type X gypsum wallboard with taped joints.

1. The fire-protective membrane shall be provided on both sides of walls and on the ceiling beneath the floor construction providing the separation. The membrane shall be fastened to the framing or suspended in the manner as required for one-hour fire-resistive rated assemblies.

2. The membrane protection may be omitted on the ceiling of the topmost story if firestopping as specified in s. ILHR 53.63 (1) (d) is provided as the intersection of the living unit separation walls and the roof.

Note 1: See s. ILHR 51.03 for building elements required to have fire-resistive ratings to satisfy class of construction standards.

Note 2: This section is intended to apply to living unit separations only. The design and construction of required fire-resistive rated construction for stairway enclosures, hazardous occupancy separations, exit corridors, isolation of hazards enclosures, vertical division walls, fire division walls and other rated construction is governed by ss. ILHR 51.043 to 51.046.

FP (3) **BASEMENT AND GROUND FLOOR PROTECTION.** (a) Except as provided in par. (b), the ceiling of all spaces, except those within individual living units and crawl spaces located below the first story of all residential buildings shall be protected with at least the equivalent of one layer of 5/8-inch type X gypsum wellboard with taped joints.

(b) This subsection shall not apply to buildings where such spaces are protected by an approved automatic sprinkler system.

(4) **GARAGE SEPARATION.** (a) Detached garages constructed in conjunction with residential occupancies shall comply with the requirements of ch. ILHR 59.

(b) Attached storage and repair garages, larger than 500 square feet in area, constructed in conjunction with residential occupancies shall comply with the requirements of ch. ILHR 59.

Register, November, 1986, No. 371

(c) 1. Attached storage garages, 500 square feet or less in area, or divided by walls having at least one-hour fire-resistive rating into areas of 500 square feet or less, shall be completely separated from the residential occupancy by at least one-hour fire-resistive rated construction. All openings in walls separating the garage from the residential occupancy shall be protected by means of self-closing fire-resistive door assemblies as specified in s. ILHR 51.047.

2. Facilities for repairing or fueling vehicles within the storage garage shall be prohibited.

(d) Attached repair garages, 500 square feet or less in area, constructed in conjunction with residential occupancies shall comply with the requirements of ch. ILHR 59.

History: Cr. Register, December, 1981, No. 312, eff. 1-1-82; am. (4) (b) and (c), cr. (4) (d), Register, December, 1983, No. 336, eff. 1-1-84; r. and recr. (2), Register, August, 1985, No. 356, eff. 1-1-86.

ILHR 57.015 Height of first floor above grade for sheltered facilities for battered women. The elevation of the first floor and the sills of all required exit discharges from the first floor for existing buildings to be converted to sheltered facilities for battered women shall be at or not more than 6 feet above an exit discharge grade.

History: Cr. Register, December, 1983, No. 336, eff. 1-1-84.

ILHR 57.016 Automatic fire sprinkler system protection. (1) **GENERAL APPLICATION.** All buildings within the scope of this chapter, except housing for the elderly, may be protected by one of the following 2 automatic fire sprinkler system options:

(a) *Option 1.* Option 1 shall include the protection of the areas within the living unit by an automatic fire sprinkler system complying with NFPA standard 13D and the protection of windowless floor levels and storage areas as specified in s. ILHR 52.012 (1) and (3), respectively, by an automatic fire sprinkler system complying with NFPA standard 13. All sprinkler heads used in Option 1 shall be of the residential type.

(b) *Option 2.* Option 2 shall include the protection of all areas within the building by an automatic fire sprinkler system complying with NFPA standard 13 and equipped with residential type sprinkler heads in the living units.

(c) *Other requirements.* Compliance with the other fire protection, detection and suppression requirements of this chapter shall be required.

Note: See ss. ILHR 51.02 (22), 57.02 (2), 57.03 (2) and 57.15 (2) for specific exceptions permitted when option 2 protection is provided.

(2) **HOUSING FOR THE ELDERLY.** All housing for the elderly shall be protected by either option 1 or option 2 as specified in sub. (1) (a) or (b).

History: Emerg. cr. eff. 9-6-86; cr. Register, November, 1986, No. 371, eff. 12-1-86.

ILHR 57.02 Allowable height and area. (1) **GENERAL.** Buildings and structures within the scope of this chapter shall not exceed the height and area limitations specified in this section.

(2) **ALLOWABLE INCREASE IN FLOOR AREAS.** (a) *Limited area ch. ILHR 57 buildings.* 1. Chapter ILHR 57 buildings not protected by automatic

Register, November, 1986, No. 371

fire sprinkler systems as specified in s. ILHR 57.016 may not exceed the height and area limitations specified in Table 57.02-1.

2. Chapter ILHR 57 buildings protected by automatic fire sprinkler systems as specified in option 1 of s. ILHR 57.016 may not exceed the height and area limitations specified in Table 57.02-2.

3. Chapter ILHR 57 buildings protected by complete automatic fire sprinkler systems as specified in option 2 of s. ILHR 57.016 may not exceed the height and area limitations specified in Table 57.02-3.

(b) *Vertical division wall separations.* 1. No building shall be limited in area when divided into sections which do not exceed the maximum areas tabulated in this section by vertical division walls. Such vertical division walls shall extend from the foundation or the first floor level if the floor construction and supporting elements are of 3-hour rated non-combustible construction, to the underside of the roof deck and shall have at least the following fire-resistive ratings:

- a. 2-hour for type 4, 5A, 5B, 7 and 8 construction;
- b. NC-2 hour for type 3 and 6 construction; and
- c. NC-3 hour for type 2 construction.

2. All openings in such walls shall be protected by fire-rated door assemblies as specified in s. ILHR 51.047. The doors protecting openings in such walls located in public corridors shall be held open and equipped with an automatic closing device activated by products of combustion other than heat.

(c) *Street access for unlimited area buildings.* 1. Streets shall be within 50 feet of the adjacent building side with no obstructions between the street and the building which will impede fire-fighting efforts.

Note: See s. ILHR 51.01 (124) for definition of street.

2. Except as provided in Table 57.02-3, buildings with no area limitations shall have a continuous all-weather, hard-surfaced area 30 feet or more in width for a distance of not less than 50% of the perimeter of the building. These buildings shall have at least one wall facing a street for its entire length. At least 2 of the remaining building walls shall face streets for at least 50% of their respective lengths.

FP (3) **ACCESS ROADWAYS FOR FIRE APPARATUS.** (a) Buildings shall be accessible to fire department apparatus by means of streets as specified in s. ILHR 51.01 (124) or access roadways. Access roadways shall be at least 20 feet in width, be capable of supporting the imposed loads of the fire apparatus and have a minimum of 13 feet 6 inches in vertical clearance.

1. For buildings 3 stories or less in height, the street or access roadway shall:

- a. Be located within 150 feet of all portions of the exterior walls of the first story; or
- b. Extend along at least one entire side of the building which constitutes at least 25% of the total building perimeter with the road edge closest to the building located at least 10 feet but not more than 50 feet from the building.

2. For buildings more than 3 stories in height, the street or access roadway shall extend along at least one entire side of the building with the road edge closest to the building at least 10 feet but not more than 50 feet from the building.

(b) The required streets and access roadways shall be kept free at all times of all obstructions, including parked vehicles and snow.

History: Cr. Register, December, 1981, No. 312, eff. 1-1-82; am. (2) (b) 2., cr. (3), Register, December, 1983, No. 336, eff. 1-1-84; am. (3) (a) 1., Register, August, 1985, No. 356, eff. 1-1-86; emerg. am. (1), r. and recr. (2), r. table 57.02, cr. tables 57.02-1, 57.02-2 and 57.02-3, eff. 9-6-86; am. (1), r. and recr. (2), r. table 57.02, cr. tables 57.02-1, 57.02-2 and 57.02-3, Register, November, 1986, No. 371, eff. 12-1-86.

NOTE: DO NOT USE FOR BUILDINGS EXCEEDING 60 FEET IN HEIGHT

CLASS OF CONSTRUCTION	STREET OR OPEN SPACE AT LEAST 30 FEET IN WIDTH WITHIN 50 FEET OF THE BUILDING	NUMBER OF STORIES								
		1	2	3	4	5	6	7	8	Over 8
1. Fire-Resistive Type A	1	19,800	17,000	14,800	12,500	10,300	8,800	7,300	6,500	5,300
	2	23,900	20,800	18,500	15,900	13,600	11,800	10,300	9,500	8,300
	3	28,000	25,300	22,300	19,300	17,000	14,800	13,300	12,500	11,300
	4	32,100	29,800	26,000	22,600	20,400	17,800	16,300	15,500	14,300
2. Fire-Resistive Type B	1	17,800	15,000	12,800	10,500	8,300	6,800	5,300	4,500	
	2	21,900	18,800	16,500	13,900	11,600	9,800	8,300	7,500	N.P.
	3	26,000	23,300	20,300	17,300	15,000	12,800	11,300	10,500	
	4	30,100	27,800	24,000	20,600	18,400	15,800	14,300	13,500	
3. Metal Frame Protected	1	15,800	13,500	11,300	9,000					
	2	19,900	17,300	14,600	12,000	N.P.	N.P.	N.P.	N.P.	N.P.
	3	24,000	21,000	18,000	15,000					
	4	28,100	24,800	21,400	18,000					
4. Heavy Timber	1	12,800	10,500	7,400	6,800					
	2	16,500	14,300	12,000	10,100	N.P.	N.P.	N.P.	N.P.	N.P.
	3	20,300	18,000	15,800	13,500					
	4	24,000	21,800	19,500	16,900					
5A. Exterior Masonry Protected	1	11,600	9,600	7,200	6,000					
	2	15,000	12,800	10,700	8,800	N.P.	N.P.	N.P.	N.P.	N.P.
	3	18,400	16,100	13,900	11,600					
	4	21,800	19,500	17,100	14,500					
5B. Exterior Masonry Unprotected	1	10,500	8,600	6,800						
	2	13,500	11,300	9,400	N.P.	N.P.	N.P.	N.P.	N.P.	N.P.
	3	16,500	14,300	12,000						
	4	19,500	17,300	14,600						
6. Metal Frame Unprotected	1	10,500	8,600	6,800						
	2	13,500	11,300	9,400	N.P.	N.P.	N.P.	N.P.	N.P.	N.P.
	3	16,500	14,300	12,000						
	4	19,500	17,300	14,600						
7. Wood Frame Protected	1	10,500	8,600	6,800						
	2	13,500	11,300	9,400	N.P.	N.P.	N.P.	N.P.	N.P.	N.P.
	3	16,500	14,300	12,000						
	4	19,500	17,300	14,600						
8. Wood Frame Unprotected	1	7,500	3,800							
	2	9,000	4,500	N.P.	N.P.	N.P.	N.P.	N.P.	N.P.	N.P.
	3	10,500	5,300							
	4	12,000	6,000							

MEANS NOT OMITTED

CLASS OF CONSTRUCTION	STREET OR OPEN SPACE AT LEAST 30 FEET IN WIDTH WITHIN 50 FEET OF THE BUILDING	NUMBER OF STORIES									
		1	2	3	4	5	6	7	8	Over 8	
1. Fire-Resistive Type A	1	39,600	34,000	29,600	25,000	20,600	17,600	14,600	13,000	10,600	
	2	47,800	41,600	37,000	31,800	27,200	23,600	20,600	19,000	16,600	
	3	56,000	50,600	44,600	38,600	34,000	29,600	26,600	25,000	22,600	
	4	64,200	59,600	52,000	45,200	40,800	35,600	32,600	31,000	28,600	
2. Fire-Resistive Type B	1	35,600	30,000	25,600	21,000	16,600	13,600	10,600	9,000	N.P.	
	2	43,300	37,600	33,000	27,800	23,200	19,600	16,600	15,000	N.P.	
	3	52,000	46,600	40,600	34,600	30,000	25,600	22,600	21,000	N.P.	
	4	60,200	55,600	48,000	41,200	36,800	31,600	28,600	27,000	N.P.	
3. Metal Frame Protected	1	31,600	27,000	22,600	18,000						
	2	39,800	34,600	29,200	24,000	N.P.	N.P.	N.P.	N.P.	N.P.	
	3	48,000	42,000	36,000	30,000						
	4	56,200	49,600	42,800	36,000						
4. Heavy Timber	1	25,600	21,000	14,800	13,600						
	2	33,000	28,600	24,000	20,200	N.P.	N.P.	N.P.	N.P.	N.P.	
	3	40,600	36,000	31,600	27,000						
	4	48,000	43,600	39,000	33,800						
5A. Exterior Masonry Protected	1	23,200	19,200	14,400	12,000						
	2	30,000	25,600	21,400	17,600	N.P.	N.P.	N.P.	N.P.	N.P.	
	3	36,800	32,200	27,800	23,200						
	4	43,600	39,000	34,200	29,000						
5B. Exterior Masonry Unprotected	1	21,000	17,200	13,600							
	2	27,000	22,600	18,800	N.P.	N.P.	N.P.	N.P.	N.P.	N.P.	
	3	33,000	28,600	24,000							
	4	39,000	34,600	29,200							
6. Metal Frame Unprotected	1	21,000	17,200	13,600							
	2	27,000	22,600	18,800	N.P.	N.P.	N.P.	N.P.	N.P.	N.P.	
	3	33,000	28,600	24,000							
	4	39,000	34,600	29,200							
7. Wood Frame Protected	1	21,000	17,200	13,600							
	2	27,000	22,600	18,800	N.P.	N.P.	N.P.	N.P.	N.P.	N.P.	
	3	33,000	28,600	24,000							
	4	39,000	34,600	29,200							
8. Wood Frame Unprotected	1	15,000	7,600								
	2	18,000	9,000	N.P.	N.P.	N.P.	N.P.	N.P.	N.P.	N.P.	
	3	21,000	10,600								
	4	24,000	12,000								

N.P. MEANS NOT PERMITTED

TABLE 57.02-3 — ALLOWABLE HEIGHT (STORIES) AND AREA (SQUARE FEET) FOR BUILDINGS WITH OPTION 2 OF S. ILHR 57.016 (MAXIMUM GROSS FLOOR AREA PER FLOOR) NOTE: USE FOR ALL BUILDINGS

Register, November, 1986, No. 371

236
ILHR 57
WISCONSIN ADMINISTRATIVE CODE
Residential occupancies

CLASS OF CONSTRUCTION	STREET OR OPEN SPACE AT LEAST 30 FEET IN WIDTH WITHIN 50 FEET OF THE BUILDING	NUMBER OF STORIES											
		1	2	3	4	5	6	7	8	9	Over 9		
1. Fire-resistive Type A stories and area may be unlimited subject to s. ILHR 57.02 (2) (c) 2.	1												
	2												
	3												
	4												
2. Fire-resistive type B 1 to 9 story area may be unlimited subject to s. ILHR 57.02 (2) (c) 2.	1												
	2	NO	53,400	45,000	38,400	31,500	24,900	20,400	15,900	13,500			N.P.
	3	LIMIT	78,000	69,900	60,900	51,900	45,000	38,400	33,900	31,500			
	4		90,300	83,400	72,000	61,800	55,200	47,400	42,900	40,500			
3. Metal frame protected 1 to 5 story area may be unlimited subject to s. ILHR 57.02 (2) (c) 2.	1												
	2		63,200	47,400	40,500	33,900	27,000	N.P.	N.P.	N.P.	N.P.	N.P.	
	3		79,600	59,700	51,900	43,800	36,000						
	4		96,000	72,000	63,000	54,000	45,000						
4. Heavy Timber 1 to 3 story area may be unlimited subject to s. ILHR 57.02 (2) (c) 2.	1												
	2		51,200	38,400	31,500	22,200	N.P.	N.P.	N.P.	N.P.	N.P.		
	3		66,000	49,500	42,900	36,000							
	4		81,200	60,900	54,000	47,400							
5A. Exterior Masonry Protected 1 to 3 story area may be unlimited subject to s. ILHR 57.02 (2) (c) 2.	1												
	2		46,400	34,800	28,800	21,600	N.P.	N.P.	N.P.	N.P.	N.P.	N.P.	
	3		60,000	45,000	38,400	32,100							
	4		73,600	55,200	48,300	41,700							
5B. Exterior Masonry Unprotected 1 story area may be unlimited subject to s. ILHR 57.02 (2) (c) 2.	1												
	2		42,000	31,500	25,800	20,400	N.P.	N.P.	N.P.	N.P.	N.P.	N.P.	
	3		54,000	40,500	33,900	28,200							
	4		66,000	49,500	42,900	36,000							
6. Metal Frame Unprotected 1 story area may be unlimited subject to s. ILHR 57.02 (2) (c) 2.	1												
	2		42,000	31,500	25,800	N.P.	N.P.	N.P.	N.P.	N.P.	N.P.	N.P.	
	3		54,000	40,500	33,900								
	4		66,000	49,500	42,900								
7. Wood Frame Protected	1												
	2		42,000	31,500	25,800	N.P.	N.P.	N.P.	N.P.	N.P.	N.P.	N.P.	
	3		54,000	40,500	33,900								
	4		66,000	49,500	42,900								
8. Wood Frame Unprotected	1												
	2		30,000	22,500	11,400	N.P.	N.P.	N.P.	N.P.	N.P.	N.P.	N.P.	
	3		36,000	27,000	13,500								
	4		42,000	31,500	15,900								

N.P. MEANS NOT PERMITTED

ILHR 57.03 Number and location of exits. (1) **NUMBER OF EXITS.** (a) Except as provided in par. (b), there shall be at least 2 directions of travel from each living unit door by means of exits to grade, stairways, interior enclosed stairways, ramps, fire escapes or horizontal exits.

(b) Living units may have 2 exits or 2 exit access doors having only one direction of travel provided the exit access doors lead to separate exits.

(c) A minimum of 2 exits or exit access doors shall be provided from any living unit which accommodates more than 8 people.

(2) **DISTANCE TO EXIT.** (a) 1. Exits shall be distributed so that the entrance to each living unit will be not more than 100 feet distant from an exit, measuring along public passageways.

Note: Also see s. ILHR 57.08 (2).

2. Where automatic fire sprinkler system protection as specified in option 2 of s. ILHR 57.016 (1) (b) is provided an increase in exit distance to 150 feet will be permitted.

(b) The exit distances required by this section shall be measured to exits to grade, to doors leading to stairway enclosures as specified in ss. ILHR 51.165, 51.17 and 51.18, or to horizontal exits as specified in s. ILHR 51.19.

(3) **EXIT DISTRIBUTION.** The number and location of exits shall be such that in case any exit or passageway is blocked at any point, some other exit will still be accessible through public passageways from every living unit.

(4) **DIRECTIONS FOR ESCAPE.** A notice shall be conspicuously posted in every habitable room to be used by transients giving complete and plain directions for reaching at least 2 exits.

(5) **EXITS FOR NONRESIDENTIAL PORTIONS OF BUILDINGS.** Exits serving portions of buildings without sleeping rooms or living units (i.e., basements of apartment buildings, hotel lobbies, and similar areas) shall be as specified in ss. ILHR 54.02 to 54.07.

History: Cr. Register, December, 1981, No. 312, eff. 1-1-82; am. (1), Register, August, 1985, No. 356, eff. 1-1-86; emerg. renum. (2) (a) to be (2) (a) 1., cr. (2) (a) 2., eff. 9-6-86; renum. (2) (a) to be (2) (a) 1., cr. (2) (a) 2., Register, November, 1986, No. 371, eff. 12-1-86.

ILHR 57.04 Capacity of buildings and exits. (1) **BUILDINGS.** (a) *Sleeping areas.* The capacity of the habitable rooms of the living units of the building, other than a community-based residential facility, shall be established as follows:

1. 400 cubic feet for each occupant over 12 years of age; and
2. 200 cubic feet for each occupant 12 years of age or under.

(b) *Minimum size.* The size of habitable rooms shall provide the minimum volumes specified in par. (a).

(c) *Nonsleeping areas.* The capacity of the areas not within the living units of the building shall be established as specified in s. ILHR 54.05 or 55.06.

(d) *Overcrowding.* The number of occupants permitted in any room or in the building shall not exceed the capacities specified in this section.

(2) **COMMUNITY-BASED RESIDENTIAL FACILITIES.** (a) *Facilities serving 9 to 20 residents.* The minimum size of resident bedrooms in community-based residential facilities serving 9 to 20 residents shall be as follows:

1. Sixty square feet of habitable floor space per ambulatory resident;
2. Eighty square feet of habitable floor space per semiambulatory or nonambulatory resident in multiple bed sleeping rooms; and
3. One hundred square feet of habitable floor space per semiambulatory or nonambulatory resident in single bed sleeping room.

(b) *Facilities serving more than 20 residents.* The minimum size of resident bedrooms in community-based residential facilities serving more than 20 residents shall be as follows:

1. Eighty square feet of habitable floor space per ambulatory resident;
2. Eighty square feet of habitable floor space per semiambulatory and nonambulatory resident in multiple bed sleeping rooms; and
3. One hundred square feet of habitable floor space per semiambulatory and nonambulatory resident in single bed sleeping rooms.

(3) **EXITS.** The total required exit width from each level of the building shall be as specified in ss. ILHR 51.15 (6) and 51.16 (3).

History: Cr. Register, December, 1961, No. 312, eff. 1-1-82.

FP ILHR 57.05 Type of exits. (1) **GENERAL.** Except as provided in sub. (2), at least one-half of the required exits, accessible from each living unit, shall be exits to grade or stairways as specified in ss. ILHR 51.15 and 51.16. The remaining exits shall be either stairways, interior enclosed stairways, exits to grade or horizontal exits. Fire escapes placed against blank walls may be used as exits from floors which are not more than 40 feet above grade.

(2) **EXCEPTIONS.** (a) Every building which accommodates more than one family, or 8 persons, above the second story shall have at least 2 stairways.

(b) A rescue platform (exterior balcony) of combustible construction may be used as a required second exit for 3-story buildings of type 5 through type 7 construction or 2-story buildings of type 8 construction, provided the following conditions are satisfied:

1. The exit serves a single living unit;
2. The exit platform is located not more than 10 feet above the adjacent exit discharge grade;
3. The platform area is at least 14 square feet, with a minimum dimension of 3 feet;
4. The platform is designed for 80 pounds per square foot live load plus dead load;
5. Railings are provided as specified in s. ILHR 51.162;
6. Platforms having solid floors are provided with a roof equal in area to that of the platform;

7. All wood used in the construction of the rescue platform shall be pressure treated wood satisfying the requirements of the applicable standards specified in s. ILHR 51.27 (6a) unless the wood is inherently resistant to decay; and

8. The building is not a residential care facility, group foster home or home for the elderly.

History: Cr. Register, December, 1981, No. 312, eff. 1-1-82; am. (2) (b) (intro.) and 6., renun. (2) (b) 7. to be (2) (b) 8., cr. (2) (b) 7., Register, December, 1983, No. 336, eff. 1-1-84.

ILHR 57.06 Doors. (1) **EXIT DOORS.** (a) *General.* Except as provided in par. (b), exit doors shall be as specified in s. ILHR 51.15.

(b) *Exception.* 1. Sliding glazed patio-type doors may serve as the second exit from individual living units. A means to prevent accumulation of snow and ice in the door track or freezing of the door shall be provided.

2. A door which is used by not more than 25 persons is not required to swing in the direction of egress.

(2) **OPENINGS INTO CORRIDORS.** All doors opening into exit access corridors shall be protected by at least 20-minute labeled fire-door assemblies. Such doors shall be self-closing.

History: Cr. Register, December, 1981, No. 312, eff. 1-1-82.

ILHR 57.07 Steps, stairs and shafts. (1) **EXTERIOR STAIRS.** Exterior stairs shall be as specified in s. ILHR 51.16, except that less than 3 steps may be provided between exterior platforms and grade serving only apartments, row houses and town houses, and the platforms or treads between such risers do not exceed 5 feet 0 inches in length in the direction of travel.

(2) **INTERIOR STAIRS.** Interior stairs used by not more than 25 persons shall be not less than 3 feet wide.

(3)* **CHANGES OF ELEVATION WITHIN INDIVIDUAL LIVING UNITS.** (a) Except as provided in par. (b), changes of elevation within the living unit shall be overcome by means or steps, stairs or ramps and shall be as specified in s. ILHR 21.04.

(b) A spiral stairway as specified in s. ILHR 51.16 (7) may serve as the only exit from floor levels, within an individual living unit, if the floor level served is no larger than 400 square feet.

History: Cr. Register, December, 1981, No. 312, eff. 1-1-82; r. and recr. (3), Register, August, 1985, No. 356, eff. 1-1-86.

ILHR 57.08 Enclosure of interior stairways and shafts. (1) **APPLICATION.** **FP** Except as provided in sub. (2), all stairways, including landings, ramps and shafts, shall be enclosed as specified in s. ILHR 51.02 (11) with fire-resistive rated construction as specified in Table 51.03-A.

(2) **EXCEPTIONS.** (a) The exit access stairway or shaft connecting the first and second floor in residential buildings 2 stories or less in height may be left open in the following applications providing the conditions specified in par. (b) are satisfied:

*See Appendix A for further explanatory material.

1. Buildings having not more than 4 individual living units per floor each of which is served by 2 or more means of egress; or

2. Buildings having an occupancy load of 8 or less and used as rooming houses, dormitories or congregate living facilities.

(b) 1. Every exit access stairway or shaft to the basement or ground floor is cut off at the first floor or first adjacent basement or ground floor level with fire resistive construction as specified in Table 51.03-A or better; and

2. The distance to an exit, including the horizontal travel distance on the exit stair, does not exceed 50 feet in buildings not completely protected with an automatic fire sprinkler system or 75 feet in buildings completely protected as specified in s. ILHR 57.016 (1) (b).

History: Cr. Register, December, 1981, No. 312, eff. 1-1-82; am. Register, October, 1982, No. 322, eff. 11-1-82; emerg. am. (2) (b) 2., eff. 9-6-86; am. (2) (b) 2., Register, November, 1986, No. 371, eff. 12-1-86.

FP ILHR 57.09 Passageways. (1) **WHERE REQUIRED.** Where there is not direct access to outside exit doors, safe and continuous passageways, aisles or corridors leading directly to every exit shall be maintained at all times on all floors of all buildings.

(2) **MINIMUM WIDTH.** Every public passageway leading from an exit shall be at least as wide as the required width of the exit as specified in s. ILHR 51.15 (6), but in no case shall the width be less than 3 feet.

(3) **WIDTH DETERMINATION.** Widths shall be measured in the clear, at their narrowest points produced by any projection, radiator, pipe or other object.

(4) **MAINTENANCE.** The required width shall be kept clear and unobstructed at all times.

History: Cr. Register, December, 1981, No. 312, eff. 1-1-82.

FP ILHR 57.10 Illumination of exits and exit signs. (1) **ILLUMINATION.** (a) Buildings having more than 4 living units or accommodating more than 30 persons or accommodating transients shall have public passageways, stairways and exit doors illuminated from one hour after sunset to one hour before sunrise.

(b) The illumination requirements specified in par. (a) shall be provided at all intersections or passageways, at all exits and at the head, foot and landing of every stairway.

(2) **EXIT LIGHTS.** (a) Except as provided in par. (b), every required exit, from each floor shall be indicated by an approved illuminated, exit sign.

(b) 1. Exits within an individual living unit need not be provided with exit signs.

2. Exits in buildings having 4 living units or less per floor need not be provided with exit signs if the building contains not more than 8 living units and the path of exit from all floor levels including the basement to the outside is readily apparent.

(c) Exit lights shall be as specified in s. ILHR 15.15 (5).

History: Cr. Register, December, 1981, No. 312, eff. 1-1-82; am. (2), Register, December, 1983, No. 336, eff. 1-1-84.

ILHR 57.11 Habitable rooms with floors below grade. (1) **GENERAL.** Living units in residential buildings other than housing for the elderly having habitable rooms or parts on floor levels below grade shall comply with the following:

(a) The grade at the building does not include the grade level within the perimeter of an areaway;

(b) Every habitable room shall have at least one exterior wall adjoining an areaway or court;

(c) Every habitable room shall have at least one outside window which can be opened from the inside without the use of tools to provide a clear opening of not less than 20 inches in width, 24 inches in height, and 5.7 square feet in area, with the bottom of the opening not more than 44 inches above the floor.

(d) All living units with floors below grade shall have access to 2 exits complying with s. ILHR 57.05, except living units having one exit door leading directly outside and not to an areaway need not have access to a second exit.

(2) **HOUSING FOR THE ELDERLY.** Living units in housing for the elderly having habitable rooms or parts on floor levels below grade shall have at least one exterior wall with a full exterior exposure from the ground floor level to the ceiling. The exterior exposure shall not be made by the construction of an areaway.

(3) **AREAWAYS.** Areaways used as specified in this section shall:

(a) Be 1½ times the depth of the bottom of the opening with a minimum width of 3 feet measured perpendicular to the building wall; and

Note: See s. ILHR 64.07 for additional requirements.

(b) Have stairway exits complying with ss. ILHR 51.16 and 52.21, when used as a required exit.

(4) **MOISTURE PROTECTION.** All buildings having living units below grade shall be designed and constructed to prevent undue collection of moisture in all stories below grade.

Note 1: Surface and subsoil drainage systems for areaways and foundation walls are regulated under the requirements of ch. ILHR 82.

Note 2: See s. ILHR 50.07 (2) Note #3 for reference to flood plain requirements.

(a) All foundation walls shall be thoroughly damp proofed prior to backfilling of soil.

(b) Provisions shall be made to prevent the accumulation of moisture due to condensation of high humidity so as to prevent slippery floors and to prevent conditions susceptible to mildew or other undesirable fungi or bacteria. The inside design conditions for cooling or dehumidification

shall be on the basis of a dry bulb temperature of 75° F. and a relative humidity not greater than 50%.

History: Cr. Register, December, 1981, No. 312, eff. 1-1-82; r. and recr. (1) (c), r. (1) (d) and (e), renun. (1) (f) to be (1) (d), Register, December, 1983, No. 336, eff. 1-1-84.

ILHR 57.12 Sanitary facilities. (1) **TOILET ROOMS.** Every building included under the scope of this chapter shall be provided with separate toilet rooms for each sex, except that a common toilet room may be provided in individual living or sleeping units.

(2) **SANITARY FIXTURES.** The number of sanitary fixtures required for each sex shall be determined in accordance with the ratios established in Table 57.12.

TABLE 57.12

Type of Occupancy	Type of Fixture					
	Water Closets (WC)		Urinals(U) Males(M)	Lavatories (L)	Bathtubs or Showers	Drinking Facilities (DF)
	Males (M)	Females (F)				
Occupancies having individual unit toilet rooms, such as hotels, motels, apartments, row houses, town houses, condominiums	One (WC) for each living unit		0	One (L) for each living unit	One for each living unit	0
Occupancies requiring communal use of sanitary facilities, such as dormitories, camps, rooming houses, foster care homes	One (WC) for each 10 (M), or fraction	One (WC) for each 10 (F), or fraction	Urinals may be substituted for up to 2/3 of the required no. of (WC)	One (L) for each 10 persons	One for each 20 persons	One (DF) for each 100 persons

(3) **EMPLOYEES.** Sanitary facilities for employees who do not sleep in the building shall be provided as specified in Table 54.12, unless the employees have access to the facilities provided for the residents.

(4) **GENERAL PUBLIC.** Sanitary facilities for the general public shall be provided as specified in Table 54.12-A or Table 54.12-B, unless the general public has access to the facilities provided for the residents.

(5) **KITCHEN SINK.** One kitchen sink, equipped with hot and cold running water, shall be provided in living units equipped for food preparation.

History: Cr. Register, December, 1981, No. 312, eff. 1-1-82.

ILHR 57.13 Windows. (1) **GENERAL.** (a) Every habitable room shall have outside windows which have a total sash area of at least 8% of the floor area of the room.

(b) Except as provided in sub. (2), the openable area of such windows shall be equal to not less than 4% of the floor area of the room served.

(2) **EXCEPTION.** Hotel and motel rooms and similar sleeping rooms in buildings accommodating transients need not be provided with openable outside windows provided the rooms have clear glazed panels facing naturally lighted roofed over pool or recreational areas. The rooms shall be

provided with mechanical ventilation supplying at least 5 CFM of tempered outside air per occupant.

Note: See s. ILHR 52.02 and 64.07 for additional requirements.

History: Cr. Register, December, 1981, No. 312, eff. 1-1-82; am. (1)(a), Register, October, 1982, No. 322, eff. 11-1-82; am. (1) (a), Register, August, 1985, No. 356, eff. 1-1-86.

ILHR 57.14 Isolation of hazards. (1) **GENERAL.** (a) *Buildings 3 or more stories.* Except as provided in par. (c), all boilers and furnaces, fuel rooms and breeching, storage vaults for paints, oils and similar combustibles and other similar hazards in buildings 3 or more stories in height shall be isolated from the rest of the building by at least a 2-hour fire-resistive rated enclosure as specified in s. ILHR 51.043.

(b) *Buildings less than 3 stories.* Except as provided in par. (c), the hazards specified in par. (a) in buildings less than 3 stories in height shall be isolated from the rest of the building by at least a one-hour fire-resistive rated enclosure as specified in s. ILHR 51.043.

(c) *Exceptions.* 1. The hourly rating of hazard enclosures in mixed use buildings shall comply with the most stringent requirement for the occupancies located in the building.

2. Gas-fired space heaters may be used within living units of apartment buildings and within habitable rooms of motels or tourist courts without an enclosure if approved by the department.

3. Space heaters fired with liquid fuel may be used without an enclosure in motels and apartment buildings not more than one story in height.

4. A residential fuel-fired clothes dryer having a rated capacity of 37,000 Btu/hour or less, may be used without an enclosure.

5. Direct vent sealed combustion chamber appliances may be used without a fire-resistive rated enclosure.

(2) **PROTECTION OF OPENINGS.** All openings in rated enclosures shall be protected by labeled self-closing fire-door assemblies as specified in s. ILHR 51.047.

History: Cr. Register, December, 1981, No. 312, eff. 1-1-82; cr. (1) (c) 5., Register, August, 1985, No. 356, eff. 1-1-86.

ILHR 57.15 Standpipes. (1) **FIRE DEPARTMENT STANDPIPES.** Fire department standpipes shall be provided in all buildings exceeding 60 feet in height.

(2) **DRY STANDPIPES.** Dry standpipes shall be provided in all buildings 3 stories or more in height which accommodate more than 20 occupants, unless an approved automatic sprinkler system as specified in Option 2 of s. ILHR 57.016 is installed.

History: Cr. Register, December, 1981, No. 312, eff. 1-1-82; emerg. r. and recr. (2), eff. 9-6-86; r. and recr. (2), Register, November, 1986, No. 371, eff. 12-1-86.

ILHR 57.16 Smoke detection. (1) **NUMBER OF DETECTORS REQUIRED FP AND LOCATION.** (a) All buildings within the scope of this chapter, except CBRF shall be provided with approved smoke detectors as specified in this section.

(b) The owner shall install at least one smoke detector:

Register, April, 1990, No. 412

1. In the basement;
2. At the head of every open stairway;
3. At the door on each floor level leading to every enclosed stairway; and
4. Either in each sleeping area of each living unit or elsewhere in the unit within 6 feet from the doorway of each sleeping area and not within a kitchen.

(c) All smoke detectors in stairways, corridors and other public places in the building shall be directly and permanently wired to a proper unswitched circuit.

1. Such detectors shall be connected to the emergency electrical power system, when the system is required by ch. ILHR 16.

2. Such detectors shall be electrically interconnected to the required manual fire alarm system. All smoke detectors, which are electrically interconnected to the manual fire alarm system, shall be a latching type, system detector intended for use with a control panel and shall utilize a supervised circuit.

Note: See s. ILHR 51.245 for additional requirements pertaining to smoke detectors.

(d) Smoke detectors shall be installed and maintained in accordance with s. 101.145 (3), Stats.

Note: Section 101.145 (3), Stats., states: "*The owner of a residential building shall install any smoke detector required under this section according to the directions and specifications of the manufacturer of the smoke detector and maintain any smoke detector which is located in a common area of that residential building. The occupant of a unit in a residential building shall maintain any smoke detector in that unit, except that if an occupant who is not an owner, or a state, county, city, village or town officer, agent or employe charged under statute or municipal ordinance with powers or duties involving inspection of real or personal property, gives written notice to the owner that a smoke detector in the unit is not functional the owner shall provide, within 5 days after receipt of that notice, any maintenance necessary to make that smoke detector functional.*"

FP (2) RETROACTIVITY. (a) The provisions of sub. (1) (a) and (b) shall apply to all buildings constructed on or after the effective date of this section and to those buildings previously constructed.

(b) 1. If the owner of a building constructed prior to the effective date of this paragraph elects to interconnect the smoke detectors with each other, no more than 6 single station, self-contained, nonlatching smoke detectors shall be so interconnected.

2. If the owner of a building constructed prior to the effective date of this paragraph elects to interconnect the smoke detectors with the manual fire alarm system, the detectors shall be a latching type, system detector intended for use with a control panel and shall utilize a supervised circuit.

History: Cr. (1), Register, December, 1981, No. 312, eff. 1-1-82; cr. (2), eff. 1-1-83; am. (1)(c) 2., Register, October, 1982, No. 322, eff. 11-1-82, am. (2), eff. 1-1-83; am. (1) (a), Register, August, 1985, No. 356, eff. 9-1-85; r. and recr. (1) (b), cr. (1) (d), Register, April, 1990, No. 412, eff. 5-1-90.

FP ILHR 57.165 Smoke detection for CBRF. (1) **GENERAL.** All CBRF within the scope of this chapter shall be provided with an approved smoke detection system.

Register, April, 1990, No. 412

(2) **TYPE OF SYSTEM.** The smoke detection system specified in sub. (1) shall be at least a low voltage interconnected smoke detection system designed to protect the entire facility and capable of sounding an alarm throughout the facility or at a central location upon actuation of any smoke detector.

(3) **SMOKE DETECTOR LOCATION.** At least 1 approved interconnected smoke detector shall be provided at the following locations:

(a) At the head of every open stairway;

(b) At the door leading to every enclosed stairway on each floor level;

(c) In every corridor, spaced not more than 30 feet apart and not further than 15 feet from any wall;

(d) In each common use room, including living rooms, dining rooms, family rooms, lounges and recreation rooms but not including kitchens; and

(e) In each sleeping room in which smoking is allowed.

(4) **APPLICABILITY.** The provisions of this section shall apply to all CBRF constructed on or after the effective date of this section and to those CBRF previously constructed.

Note: See s. ILHR 51.245 for additional requirements pertaining to smoke detectors.

History: Cr. Register, August, 1985, No. 356, eff 9-1-85.

ILHR 57.17 Fire alarms. (1) **GENERAL.** (a) Except as provided in par. **FP** (b), every building, which can accommodate 20 or more persons, as determined by the requirements specified in s. ILHR 57.04, shall be provided with a manual fire alarm system as specified in s. ILHR 51.24.

(b) Residential occupancies, including hotels and motels, not more than one story in height in which each living unit has a primary swinging exit door at grade level are exempted from the provisions of par. (a).

(2) **APPLICATION.** This section shall apply to all buildings in existence on the effective date of this section and to those buildings constructed thereafter.

History: Cr. Register, December, 1981, No. 312, eff. 1-1-82; am. (1), Register, October, 1982, No. 322, eff. 11-1-82; am. (1) (b), Register, December, 1983, No. 336, eff. 1-1-84.

ILHR 57.18* Fire extinguishers. (1) **GENERAL.** Portable fire extinguishers shall be provided in buildings more than one story in height. The extinguishers shall be located in the public areas of the building and comply with the requirements of Table 57.18. **FP**

Table 57.18

Basic Minimum Extinguisher Rating	Maximum Travel Distance to Extinguisher (feet)	Area to be Protected per Extinguisher (sq. ft.)
1A	75	3,000
2A	75	6,000

*See Appendix A for further explanatory material.

(2) LOCATION. (a) Extinguishers shall be conspicuously located where they are readily accessible and immediately available in the event of fire.

(b) Extinguishers shall not be obstructed or obscured from view.

FP (3) MAINTENANCE. Portable fire extinguishers shall be maintained as specified in s. ILHR 51.22.

History: Cr. Register, December, 1981, No. 312, eff. 1-1-82; emerg. am. (1), eff. 9-6-86; am. (1), Register, November, 1986, No. 371, eff. 12-1-86.

FP ILHR 57.19 Rowhouse. (1) VERTICAL OCCUPANCY SEPARATIONS. (a) Each living unit shall be separated from the adjacent living unit by a vertical occupancy separation of not less than one hour fire-resistive construction, extending from the foundation to the underside of the roof deck.

(b) Piercing of the vertical occupancy separation between the units by doors or windows shall be prohibited.

(c) Piercing of the vertical occupancy separation by mechanical, electrical or plumbing elements may be permitted provided the piercing is as specified in s. ILHR 51.049 and it does not violate the hourly rating of the wall.

Note: Mechanical, electrical or plumbing systems may be located in the occupancy separation wall and components may penetrate one or both sides of the wall within the same stud space. See s. ILHR 51.049 (3) for additional requirements pertaining to plastic components.

(2) EXITS. Each living unit shall have a separate exit within 3 feet of the exit discharge grade.

(3) ATTIC ACCESS. Each living unit shall have attic access as specified in s. ILHR 51.02 (18) (a). Compliance with the provisions of s. ILHR 51.02 (18) (b) is not required.

(4) EXCEPTIONS. Where each living unit has a separate heating system, compliance with ss. ILHR 57.14 and 57.17 is not required.

History: Cr. Register, December, 1981, No. 312, eff. 1-1-82; renum. (1) (a) and (b) to be (1) (b) and (c), cr. (1) (a), Register, August, 1985, No. 356, eff. 1-1-86.

Chapter ILHR 58

HEALTH CARE,
 DETENTION AND CORRECTIONAL FACILITIES

Subchapter I
 Health Care Facilities

SCOPE
 ILHR 58.001 Scope (p. 246)

GENERAL REQUIREMENTS
 ILHR 58.01 Class of construction (p. 246)
 ILHR 58.02 Separation from other occupancies (p. 247)
 ILHR 58.03 Windows (p. 248)

MEANS OF EGRESS REQUIREMENTS
 ILHR 58.04 Required means of egress (p. 248)
 ILHR 58.05 Number and type of exits (p. 249)
 ILHR 58.06 Stairs (p. 249)
 ILHR 58.07 Handrails (p. 249)
 ILHR 58.08 Guardrails (p. 250)
 ILHR 58.09 Smokeproof towers (p. 250)
 ILHR 58.10 Horizontal exits (p. 250)
 ILHR 58.11 Ramps (p. 250)
 ILHR 58.12 Capacity of means of egress (p. 251)
 ILHR 58.13 Arrangement of means of egress (p. 251)
 ILHR 58.14 Measurement of travel distance to exits (p. 252)
 ILHR 58.15 Discharge from exits (p. 252)
 ILHR 58.16 Illumination of means of egress (p. 253)
 ILHR 58.17 Emergency lighting (p. 253)
 ILHR 58.18 Marking of means of egress (p. 253)
 ILHR 58.19 Headroom (p. 253)
 ILHR 58.20 Key locking hardware (p. 253)

PROTECTION
 ILHR 58.21 Protection of openings (p. 254)
 ILHR 58.22 Elevator lobby enclosures (p. 254)
 ILHR 58.23 Protection of vertical openings (p. 254)
 ILHR 58.24 Protection from hazards (p. 255)
 ILHR 58.25 Rubbish chutes and laundry chutes (p. 256)
 ILHR 58.26 Interior finish (p. 257)
 ILHR 58.27 Detection, alarm and communication systems (p. 257)
 ILHR 58.28 Standpipes (p. 258)
 ILHR 58.29 Automatic sprinkler and other suppression systems (p. 259)
 ILHR 58.30 Smoke barrier (p. 259)
 ILHR 58.31 Construction of corridor walls (p. 261)

SANITARY FACILITIES
 ILHR 58.32 Sanitation requirements (p. 263)

Subchapter II
 Detention and Correctional Facilities

SCOPE
 ILHR 58.40 Scope (p. 263)
 ILHR 58.41 Definitions (p. 263)
 ILHR 58.42 Class of construction (p. 264)
 ILHR 58.43 Program support facilities (p. 264)
 ILHR 58.44 Separation from other occupancies (p. 265)
 ILHR 58.45 Windows (p. 265)
 ILHR 58.46 Size of sleeping rooms (p. 265)
 ILHR 58.47 Sleeping rooms below grade (p. 265)

MEANS OF EGRESS REQUIREMENTS
 ILHR 58.48 Required means of egress (p. 266)
 ILHR 58.49 Exit doors, number and type of exits (p. 266)
 ILHR 58.50 Stairways (p. 267)
 ILHR 58.51 Smokeproof towers (p. 267)
 ILHR 58.52 Horizontal exits (p. 267)
 ILHR 58.53 Ramps (p. 267)
 ILHR 58.54 Required exit width (p. 268)
 ILHR 58.55 Arrangement of means of egress (p. 268)
 ILHR 58.56 Measurement of travel distance to exits (p. 268)
 ILHR 58.57 Illumination of means of egress (p. 269)
 ILHR 58.575 Emergency lighting (p. 269)
 ILHR 58.58 Marking of means of egress (p. 269)
 ILHR 58.59 Door locks (p. 269)

PROTECTION
 ILHR 58.60 Protection of openings (p. 270)
 ILHR 58.61 Protection of vertical openings (p. 271)
 ILHR 58.62 Isolation of hazards (p. 271)
 ILHR 58.63 Standpipes (p. 272)
 ILHR 58.635 Fire extinguishers (p. 272)
 ILHR 58.64 Fire alarms (p. 272)
 ILHR 58.65 Automatic smoke detection system (p. 273)
 ILHR 58.66 Interior finishes (p. 273)
 ILHR 58.67 Smoke barrier (p. 273)

SANITARY FACILITIES
 ILHR 58.68 Sanitation requirements (p. 274)

GUARD TOWERS
 ILHR 58.69 Guard towers and observation stations (p. 275)

Note: Chapter Ind 58 was renumbered to be chapter ILHR 58 effective January 1, 1984.

Subchapter I—Health Care Facilities

SCOPE

ILHR 58.001 Scope. GENERAL. The provisions of this subchapter shall apply, on or after the effective date of this section, to the following:

(a) New health care facilities and additions to existing health care facilities;

(b) Alterations and remodeling affecting structural strength, fire hazard, natural lighting or replacement of major equipment. Alterations and remodeling do not include minor repairs necessary for the maintenance of any building or structure. Where buildings are being remodeled or altered, only those components or systems being remodeled or altered shall be made to conform with the rules in effect at the time the remodeling or alteration occurs; and

(c) Change of use where the requirements for the new use are more stringent than those for the previous use.

(2) **APPLICATION.** (a) The rules of this subchapter are not retroactive unless specifically stated in the individual administrative rule.

(b) The rules of this subchapter do not apply to alterations or remodeling of buildings, constructed prior to the effective date of this paragraph, being undertaken solely for the purpose of obtaining federal certification or state licensure.

(c) Where other sections of chs. ILHR 50-64 specify different requirements than those contained in this subchapter, the requirements of this subchapter shall govern.

(3) **VARIANCE.** Where explicit conformance with the rules of this subchapter is not attained, the department will consider and may grant a variance as specified in s. ILHR 50.25. The department will consider the results obtained from nationally recognized evaluation procedures (for example, Fire Safety Evaluation System (FSES) as specified in Appendix C of the National Fire Protection Association (NFPA) Life Safety Codes 101-1981) in evaluating requests for variance.

Special Note: The purpose of this subchapter is to eliminate conflicting rules between DILHR and DH&SS. DH&SS is involved with the enforcement of the federal requirements for the Title XVIII (Medicare) and Title XIX (Medicaid) programs. Since the basis of the federal program for construction purposes is compliance with the NFPA, 101 Life Safety Code, the rules of this subchapter reflect the rules of the NFPA, 101 Life Safety Code, 1981 edition.

History: Cr. Register, December, 1981, No. 312, eff. 1-1-82; cr. (2) (c), Register, October, 1982, No. 322, eff. 11-1-82.

GENERAL REQUIREMENTS

ILHR 58.01 Class of construction. (1) **TWO OR MORE STORIES.** Except as provided in par. (d), all health care facilities 2 or more stories in height shall be of fire-resistive type 1 construction as specified in s. ILHR 51.03 (1) with the following modifications:

(a) *Floor framing support assemblies.* Floor framing support assemblies shall have a minimum fire-resistive rating of 2 hours.

Register, August, 1985, No. 356

(b) *Roof assemblies.* Roof assemblies shall have a minimum fire-resistive rating of 1½ hours.

(c) *Exterior bearing walls.* All exterior bearing walls shall have a minimum fire-resistive rating of 3 hours.

(d) Health care facilities up to and including 3 stories in height may be of Type 3 construction if completely protected by an approved automatic fire sprinkler system.

(2) ONE-STORY CONSTRUCTION. (a) *Hospitals.* 1. Except as provided in subd. 2., one story hospitals shall be of type 3 metal frame protected construction or better as specified in Table 51.03-A with the following specifications:

a. Roof framing assemblies for types 1, 2 and 3 construction shall have a minimum fire-resistive rating of one hour.

b. All exterior bearing walls of type 3 construction shall have a minimum fire-resistive rating of one hour.

2. One story hospitals provided with a complete automatic fire sprinkler system installed in accordance with s. ILHR 51.23 may be of type 7, wood frame protected construction or better as specified in Table 51.03-A.

(b) *Nursing homes.* One story nursing homes shall be of type 7 wood frame protected construction or better as specified in Table 51.03-A.

History: Cr. Register, December, 1981, No. 312, eff. 1-1-82; am. (2) (a) 2., Register, October, 1982, No. 322, eff. 11-1-82; am. (1) (a), r. and recr. (2), Register, December, 1983, No. 336, eff. 1-1-84; am. (1) (intro.) and cr. (1) (d), Register, August, 1985, No. 356, eff. 1-1-86.

ILHR 58.02 Separation from other occupancies. (1) OCCUPANCY SEPARATIONS. Occupancies not within the scope of this subchapter built in connection with any health care facility, shall be separated from any such health care facility by at least 2-hour fire-resistive rated construction as specified in s. ILHR 51.04, except as provided in subs. (2) and (3). Auditoriums, chapels, residential facilities and other similar areas provided for the patients or employes of health care facilities, need not be separated with rated construction, but shall comply with the exiting requirements of chs. ILHR 54-62, as appropriate.

(2) OUTPATIENT SERVICES. Doctor's offices, medical clinics and similar facilities which are primarily intended to provide outpatient services will be classified as a ch. ILHR 54 occupancy provided the facilities are separated from health care occupancies by not less than 2-hour fire-resistive rated construction. Class of construction separations shall comply with s. ILHR 51.02 (20).

(3) GARAGES. (a) Storage garages and repair garages shall be separated from health care facilities as specified in s. ILHR 59.22.

(b) Areas accommodating emergency vehicles for temporary loading or unloading purposes need not be separated from health care facilities. The storage or repair of the vehicles is prohibited in these areas.

(4) OPENINGS. All openings in occupancy separations shall occur only in corridors and shall be protected by fire-resistive door assemblies as specified in s. ILHR 58.21.

(5) **EXITING FROM MIXED OCCUPANCIES.** Required means of egress from health care occupancies may exit through non-health care occupancies provided the means of egress complies with the requirements specified in this subchapter.

History: Cr. Register, December, 1981, No. 312, eff. 1-1-82; am. (3) (a), Register, October, 1982, No. 322, eff. 11-1-82; am. (4), Register, December, 1983, No. 336, eff. 1-1-84; cr. (5), Register, August, 1985, No. 356, eff. 1-1-86.

ILHR 58.03 Windows. (1) **OUTSIDE WINDOWS.** Every habitable room shall be provided with outside windows having a total sash area of at least 8% of the floor area of the room. The bottom of the window opening in sleeping rooms, shall be not more than 36 inches above the floor.

(2) **VENTILATION.** (a) *Where required.* Every patient sleeping room and every habitable room shall have an outside window or outside door located so it can be opened from the inside to permit the venting of products of combustion and to permit any occupant to have direct access to outside air in case of an emergency. Where windows require the use of tools or keys for operation, written approval from the department shall be obtained. The keys or tools shall be accessible to staff and located on each floor having such windows.

(b) *Openable area of outside windows.* The openable area of outside windows shall be equal to at least 4% of the floor area served, except as follows:

1. Rooms intended for occupancy for less than 24 hours, such as those housing obstetrical labor beds, recovery beds, observation beds in emergency department and newborn nurseries;

2. Rooms where persons are forcibly confined, such as psychiatric wards, alcohol and drug abuse areas or other similar areas of protective placement; or

3. Buildings designed with an engineered smoke control system as specified in NFPA 90A, Standard for the Installation of Air Conditioning and Ventilating Systems.

History: Cr. Register, December, 1981, No. 312, eff. 1-1-82;

MEANS OF EGRESS REQUIREMENTS

FP ILHR 58.04 Required means of egress. (1) **GENERAL.** All required means of egress shall comply with the requirements as specified in s. ILHR 51.15, except as modified in this section.

(2) **EXIT DOORS.** (a) *Width.* All exit doors shall be not less than 44 inches and not more than 48 inches in width, except that doors serving enclosed stairways may be a minimum of 36 inches in width.

(b) *Door swing.* A door which is used by 25 persons or less shall not be required to open in the direction of egress.

(c) *Force to open door.* The force required to fully open doors shall not exceed 37 pounds applied to the latch side.

(d) *Door platforms.* The floor on both sides of an exit door, except as specified in s. ILHR 51.16 (4) (c), shall be at the same elevation and be level for a distance at least the width of the door, or as specified in s. ILHR 52.04 (9) (b).

Register, August, 1985, No. 356

INDUSTRY, LABOR AND HUMAN RELATIONS 249

Health care, detention and correctional facilities

ILHR 58

(3) **EXIT ACCESS DOORS.** (a) *Width.* 1. All exit access doors from hospital and nursing home sleeping rooms; patient or resident use areas; diagnostic and treatment areas, such as x-ray, surgery, or physical therapy; and all doors between these spaces and the required exits shall be at least 44 inches wide.

2. Exit access doors not subject to use by patients, shall be at least 36 inches wide.

(b) *Door swing.* A door which is used by not more than 25 persons shall not be required to open in the direction of egress.

History: Cr. Register, December, 1981, No. 312, eff. 1-1-82; am. (2) (b), Register, October, 1982, No. 322, eff. 11-1-82.

ILHR 58.05 Number and type of exits. (1) **NUMBER.** At least 2 exits, located remote from each other, shall be provided from each floor and fire section of the building. FP

(2) **TYPE OF EXITS.** (a) At least one exit from each floor or smoke compartment shall be by a door leading directly to a stairway, smokeproof tower, ramp, horizontal exit, exit passageway, or to the outside the building as specified in this subchapter.

(b) No more than one-half of the required exits shall be horizontal exits.

History: Cr. Register, December, 1981, No. 312, eff. 1-1-82.

ILHR 58.06 Stairs. (1) **STAIR DETAILS.** All stairs shall comply with the requirements specified in ss. ILHR 51.16 and 51.164, except as modified in this section. FP

(a) All stairways and steps shall have a rise of not more than 7 inches and not less than 4 inches and a tread not less than 11 inches, measured from tread to tread and from riser to riser. Treads and risers shall be uniform in any one flight. Winders shall not be used. Treads shall be solid.

(b) Every landing or platform shall be at least as wide as the stairway, measured at right angles to the direction of travel. The length of every landing or platform shall be at least as wide as the stairway. The length of the landing or platform need not exceed 48 inches.

(c) The aggregate width for stairways shall comply with the requirements specified in s. ILHR 58.12.

(2) **ENCLOSURE.** (a) All stairways shall be enclosed as specified in s. ILHR 51.18.

(b) Stairways in addition to those required by these rules, need not lead to the outside, but shall comply with the enclosure requirements.

(c) Non-required exit stairways and ramps connecting different levels within the same floor as defined in s. ILHR 51.02 (56a) are not required to be enclosed.

History: Cr. Register, December, 1981, No. 312, eff. 1-1-82; am. (1) (a) and (2) (a), Register, October, 1982, No. 322, eff. 11-1-82; r. and recr. (1) (a), Register, December, 1983, No. 336, eff. 1-1-84; cr. (2) (c), Register, August, 1985, No. 356, eff. 1-1-86.

ILHR 58.07 Handrails. Handrails shall be provided as specified in s. ILHR 51.161, except that handrails protecting the open sides of stair-

Register, August, 1985, No. 356

ways and ramps shall have intermediate rails or an ornamental pattern designed to prevent the passage of an object with a diameter larger than 6 inches.

History: Cr. Register, December, 1981, No. 312, eff. 1-1-82; am. Register, August, 1985, No. 356, eff. 1-1-86.

ILHR 58.08 Guardrails. Guardrails shall be provided as specified in s. ILHR 51.162, except that guardrails shall have intermediate rails or an ornamental pattern designed to prevent the passage of an object with a diameter larger than 6 inches.

History: Cr. Register, December, 1981, No. 312, eff. 1-1-82.

ILHR 58.09 Smokeproof towers. Smokeproof stair towers shall comply with the requirements specified in ss. ILHR 51.17, 58.04 and 58.06.

ILHR 58.10 Horizontal exits. (1) **GENERAL.** Horizontal exits shall comply with the requirements specified in s. ILHR 51.19, except as modified in this section.

(2) **AREA.** At least 30 net square feet per occupant in a facility shall be provided within areas such as corridors, patient rooms, treatment rooms, lounge or dining areas on each side of the horizontal exit for the total number of people in the adjoining compartment.

(3) **DOORS.** (a) A single door used as a horizontal exit shall serve one direction only, be at least 44 inches wide, swing in the direction of egress and comply with the requirements specified in s. ILHR 58.21.

(b) A horizontal exit in a corridor 8 feet or more in width serving as a means of egress from both sides of the doorway shall have the opening protected by a pair of swinging doors, arranged to swing in the opposite direction from the other, with each door being at least 44 inches wide.

(c) Center mullions are prohibited.

(d) A vision panel, complying with the requirements specified in s. ILHR 51.048 and not exceeding 100 square inches, shall be provided in each horizontal exit door. Vision panels shall be set in steel frames and shall be tested as part of the entire rated door assembly.

(4) **RESTRICTIONS.** If a horizontal exit is used as a smoke barrier it shall comply with the requirements specified in s. ILHR 58.30.

History: Cr. Register, December, 1981, No. 312, eff. 1-1-82; am. (2), Register, December, 1983, No. 336, eff. 1-1-84.

ILHR 58.11 Ramps. (1) **MINIMUM WIDTH.** (a) *Interior ramps.* Interior ramps shall be a minimum of 44 inches wide, of which not more than 4 inches on each side may be occupied by a handrail.

(b) *Exterior ramps.* Exterior ramps shall be a minimum of 48 inches wide of which not more than 4 inches on each side may be occupied by a handrail.

(2) **SLOPE.** Ramps shall have a slope of not more than 1 foot of rise in 12 feet of run.

(3) **ENCLOSURE.** Ramps used as a required means of egress and that connect different floors shall comply with the enclosure requirements for stairways specified in s. ILHR 58.06 (2).

Register, August, 1985, No. 356

(4) **LANDINGS AND PLATFORMS.** (a) If a door is provided at the top or bottom or both of a ramp, a landing or platform shall be placed between the door and the ramp regardless of the direction of swing of the door.

(b) Every landing or platform shall be at least as wide as the ramp, measured at right angles to the direction of travel. The length of every landing or platform shall be at least as wide as the ramp, but need not exceed 48 inches.

History: Cr. Register, December, 1981, No. 312, eff. 1-1-82; cr. (4), Register, December, 1983, No. 336, eff. 1-1-84; am. (3), Register, August, 1985, No. 356, eff. 1-1-86.

ILHR 58.12 Capacity of means of egress. (1) **OCCUPANT LOAD.** (a) *Capacity.* The occupant load for which means of egress shall be provided for any floor shall be the maximum number of persons to occupy that floor, but not less than one person for each 120 square feet gross floor area.

(b) *Exits serving more than one floor.* Where exits serve more than one floor, only the occupant load of each floor considered individually need to be used in computing the capacity of the exits at that floor, provided the exit capacity is not decreased in the direction of exit travel.

(2) **REQUIRED EXIT WIDTH.** (a) *Units of exit width.* The required exit width shall be measured in units of exit width of 22 inches. Fractions of a unit less than 12 inches shall not be counted. Fractions of a unit 12 inches or more, added to one or more full units, shall be counted as 1/2 unit of exit width.

(b) *Clear width.* The clear width of the means of egress shall be measured at the narrowest point of the exit component under consideration, except as provided below:

1. The exit width for doorways shall be the measured width of each door leaf;
2. A handrail may project inside the measured width on each side not more than 4 inches; or
3. A stringer may project inside the measured width on each side not more than 1½ inches.

(3) **CAPACITY PER UNIT OF EXIT WIDTH.** (a) *Stairways.* The capacity of means of egress providing travel by means of stairs shall be 22 persons per exit unit, except that in buildings protected with a complete automatic sprinkler system the capacity shall not exceed 35 persons per exit unit.

(b) *Horizontal travel.* The capacity of means of egress providing horizontal travel, such as doors, ramps, or horizontal exits shall be 30 persons per exit unit, except that in buildings protected with a complete automatic sprinkler system the capacity shall not exceed 45 persons per exit unit.

History: Cr. Register, December, 1981, No. 312, eff. 1-1-82.

ILHR 58.13 Arrangement of means of egress. (1) **PATIENT SLEEPING ROOMS.** Every patient sleeping room shall have an exit access door leading directly to an exit access corridor, except as provided below:

(a) If there is an exit door opening directly to the outside from the room at ground level; or

(b) One adjacent room, such as a sitting room or anteroom, may intervene, if all doors along the means of egress are equipped with nonlockable hardware, except as specified in s. ILHR 51.15 (3), and if the intervening room is not used to serve as an exit access for more than 8 patient sleeping beds.

(2) **CORRIDORS.** Every aisle, corridor and hallway shall provide access to at least 2 exits complying with the requirements specified in s. ILHR 58.05.

(a) *Dead end corridor.* Every exit or exit access shall be so arranged that no corridor, aisle or passageway has a pocket or dead end exceeding 30 feet.

(b) *Exit access corridors.* 1. Every aisle, corridor and hallway used for exit access shall be at least 8 feet in clear and unobstructed width of which not more than 4 inches on each side may be occupied by a handrail.

2. Where doors are placed in the exit access corridor, they shall be a pair of doors, each at least 44 inches in width. Where the exit access corridor serves as a means of egress from both sides of the doorway, the doors shall be arranged to swing in the opposite direction from the other.

(c) *Areas not intended for patient use.* Aisles, corridors and hallways in areas not intended for the housing, treatment or use of patients shall be at least 44 inches in clear and unobstructed width.

(3) **SUITE EXITING.** Any room, suite of rooms, space or area more than 1,000 square feet in area, shall have at least 2 exit access doors remote from each other.

History: Cr. Register, December, 1981, No. 312, eff. 1-1-82; am. (2) (a), Register, December, 1983, No. 336, eff. 1-1-84; renum. (2) (a) and (b) to be (2) (b) and (c), cr. (2) (a), r. (3), renum. (4) to be (3), Register, August, 1985, No. 356, eff. 1-1-86.

ILHR 58.14 Measurement of travel distance to exits. All exits of health care facilities shall be located to provide remote means of egress.

(1) **EXIT ACCESS TO AN EXIT.** Travel distance measured along passageways between any room door required as an exit access and an exit shall not exceed 100 feet, except that in buildings protected with a complete automatic sprinkler system the distance shall not exceed 150 feet.

(2) **ROOM TO AN EXIT.** Travel distance measured along passageways between any point in a room and an exit shall not exceed 150 feet, except that in buildings protected with a complete automatic sprinkler system the distance shall not exceed 200 feet.

(3) **SLEEPING ROOM TO AN EXIT ACCESS.** Travel distance measured along passageways between any point in a health care sleeping room or suite and an exit access door to that room or suite shall not exceed 50 feet.

History: Cr. Register, December, 1981, No. 312, eff. 1-1-82.

ILHR 58.15 Discharge from exits. All required ramps or stairs serving as exits shall discharge directly to the outside at grade or be arranged to travel through an exit passageway discharging to the outside at grade.

Register, August, 1985, No. 356

Unenclosed exterior ramps or stairways may not be used as required exits as specified in s. ILHR 58.04.

History: Cr. Register, December, 1981, No. 312, eff. 1-1-82; am. Register, August, 1985, No. 356, eff. 1-1-86.

ILHR 58.16 Illumination of means of egress. (1) **ILLUMINATION.** Artificial lighting shall be provided at all exits and for such period of times as required to maintain safe exiting.

(2) **ILLUMINATION LEVEL.** The floors of means of egress shall be illuminated at all points including angles and intersections of corridors and passageways, stairways, landings of stairs and exit doors to the values specified in ch. Ind 19.

History: Cr. Register, December, 1981, No. 312, eff. 1-1-82.

ILHR 58.17 Emergency lighting. Emergency lighting shall comply with the requirements specified in ch. ILHR 16.

History: Cr. Register, December, 1981, No. 312, eff. 1-1-82.

ILHR 58.18 Marking of means of egress. (1) **EXIT SIGNS.** Every required exit shall be identified with an internal illuminated, red exit sign bearing the word "EXIT" or "OUT" in plain letters not less than 6 inches high, with the principal strokes of letters not less than 3/4 inches. **FP**

(2) **DIRECTIONAL SIGNS.** An illuminated sign, not less than 6 inches high, reading "EXIT" or similar designation, with an arrow indicating the direction, shall be placed in every location where the direction of travel to reach the nearest exit is not immediately apparent.

(3) **OBSTRUCTIONS.** (a) Decorations, furnishings or equipment which impair visibility of an exit sign shall not be permitted. Displays, objects in or near the line of vision to the required exit sign or brightly illuminated signs used for purposes other than exits shall not be permitted so as to detract attention from the exit sign.

(b) Hangings or draperies shall not be placed over exit doors or be located as to conceal or obscure any exit. Mirrors shall not be placed on exit doors. Mirrors shall not be placed in or adjacent to any exit in such a manner as to confuse the direction of exit.

(4) **SPECIAL SIGNS.** Any door, passage, or stairway which is neither an exit nor a way of exit access, and which is located or arranged that it may be mistaken for an exit, shall be identified by a sign indicating it is not an exit.

History: Cr. Register, December, 1981, No. 312, eff. 1-1-82.

ILHR 58.19 Headroom. Every means of egress shall be provided with a ceiling clearance of not less than 7 feet 6 inches.

History: Cr. Register, December, 1981, No. 312, eff. 1-1-82.

ILHR 58.20 Key locking hardware. Key locking hardware on exit doors and exit access doors is prohibited except in areas accommodating residents who must be detained for their protection and the protection of the general public and the building complies with the requirements of ch. **FP**

ILHR 58, subchs. I and II. Where the requirements of the 2 subchapters differ, the additional or more stringent requirement shall govern.

History: Cr. Register, December, 1981, No. 312, eff. 1-1-82; r. and recr. Register, December, 1983, No. 336, eff. 1-1-84.

PROTECTION

FP ILHR 58.21 Protection of openings. (1) **DOORS.** Doors protecting openings in occupancy separations, smoke barriers, or horizontal exits shall be fire-resistive door assemblies as specified in s. ILHR 51.047.

(2) **CLOSING DEVICE.** Doors protecting such openings shall be equipped with a closing device and shall normally be kept closed, except the doors may be held open by a hold open device actuated by products of combustion other than heat. The closing device shall be arranged such that the activation of any one or all of the following systems will initiate the self-closing action of all such doors:

(a) Manual fire alarm system;

(b) Automatic smoke detection system or a local device designed to detect smoke on either side of the opening; and

(c) Automatic sprinkler system or fire detection system, if provided.

History: Cr. Register, December, 1981, No. 312, eff. 1-1-82; am. (1), (2) (intro.) and (c), Register, December, 1983, No. 336, eff. 1-1-84.

FP ILHR 58.22 Elevator lobby enclosures. (1) **GENERAL.** All elevator lobbies shall be enclosed with at least one-hour fire-resistive construction as specified in s. ILHR 51.04, to limit the spread of smoke and fire. All openings shall be protected with fire-resistive door assemblies as specified in s. ILHR 58.21.

(2) **OPENINGS IN THE ENCLOSURE.** Openings in the elevator lobby enclosure shall be limited to exit access doors serving public passageways or corridors and openings into elevator shaft enclosures. The elevator lobby shall not be used as a portion of the exit access passageway.

History: Cr. Register, December, 1981, No. 312, eff. 1-1-82; am. Register, December, 1983, No. 336, eff. 1-1-84; r. and recr. Register, August, 1985, No. 356, eff. 1-1-86.

FP ILHR 58.23 Protection of vertical openings. (1) **INTERIOR SHAFTS.** Every elevator shaft, dumbwaiter shaft, pipe shaft and other similar vertical shaft in buildings, shall be enclosed as specified in Table 51.03-A, except as provided in pars. (a) and (b):

(a) One-hour rated enclosures are permitted in hospitals of type 3 construction; or

(b) Duct penetrations of floor assemblies which are protected as specified in NFPA 90A, Standard for the Installation of Air Conditioning and Ventilating Systems.

(2) **ESCALATORS.** All escalators shall be enclosed as specified in s. ILHR 58.06 (2).

History: Cr. Register, December, 1981, No. 312, eff. 1-1-82; am. (1) (intro.), Register, October, 1982, No. 322, eff. 11-1-82.

Register, August, 1985, No. 356

ILHR 58.24 Protection from hazards. (1) ENCLOSURES. (a) General. All hazards listed in Table 58.24-A shall be enclosed from other areas of the building with fire-resistive rated construction as specified in Table 58.24-A.

(b) *Openings.* 1. All openings into boiler, furnace or emergency generator enclosures shall be protected with self-closing fire-resistive door assemblies as specified in s. ILHR 51.047.

2. All openings into other hazard enclosures shall be protected with fire-resistive door assemblies as specified in ss. ILHR 51.047 and 58.21.

TABLE 58.24-A

HAZARDS	FIRE-RESISTIVE RATING IN HOURS	
	Buildings 3 Stories or Less ¹	Buildings Over 3 Stories
Boilers (including fuel room and breeching)	2	3
Furnaces (including fuel room and breeching)	2	3
Laundries and drying rooms	2	3
Emergency generators (cannot be located in boiler or furnace room)	2	3

¹The minimum hourly ratings specified may be reduced by one hour in buildings less than 3 stories in height and protected by complete automatic fire sprinkler system. The minimum rating shall not be less than one hour.

(2) **SEPARATIONS.** All hazards listed in Table 58.24-B shall be vertically separated from other areas of the building with fire-resistive rated construction as specified in Table 58.24-B. All openings shall be protected with fire-resistive door assemblies as specified in s. ILHR 51.047.

TABLE 58.24-B

HAZARDS	FIRE RESISTIVE RATING IN HOURS
†Soiled Linen Rooms	1
Kitchens ¹	1
Handicraft Shops ¹	1
†Carpenter Shops	1
Repair Shops ¹	1
†Paint Shops	1
†Trash Collection Rooms	1
†Storage Rooms (containing quantities of flammable or combustible material exceeding 1 lb. of material per square foot of floor area)	1
Gift Shops ¹	1
†Laboratories (containing quantities of flammable or combustible material exceeding 1 lb. of material per square foot of floor area)	1
— All other laboratories ¹	1
Employe Locker Rooms ¹	1

†These areas are required to be protected with an automatic sprinkler system in addition to the fire-resistive enclosure requirements specified in the table.

¹The minimum hourly ratings specified may be reduced to a smoke separation with a self-closing door in buildings protected by a complete automatic sprinkler system.

(3) FIREPLACES. Fireplaces shall be permitted in health care facilities provided:

(a) The fireplace is installed and used in areas other than patient sleeping areas which are separated from the patient sleeping areas by construction having at least a one-hour fire-resistive rating;

(b) The fireplace is equipped with safety screens and a heat tempered glass fireplace enclosure capable of withstanding temperatures of 650° F.; and

(c) Combustion air for the fireplace is taken directly from outside the building.

History: Cr. Register, December, 1981, No. 312, eff. 1-1-82; am. Table 58.24-B, Register, October, 1982, No. 322, eff. 11-1-82; am. (1) and (2), cr. (3), r. and recr. Table 58.24-A, am. Table 58.24-B, Register, December, 1983, No. 336, eff. 1-1-84.

FP ILHR 58.25 Rubbish chutes and laundry chutes. (1) VERTICAL PROTECTION. Any rubbish chute or laundry chute shall be enclosed with walls or partitions of at least 2-hour fire-resistive construction specified in s. ILHR 51.043, except that horizontal portions of pneumatic rubbish and laundry chute systems need not be enclosed. All openings shall be protected with fire-resistive door assemblies as specified in ss. ILHR 51.047 and 58.21 (2), and shall include the opening from the chute into the collection room.

(a) All rubbish chutes may discharge into trash collecting rooms, which are used for no other purpose and are enclosed as specified in Table 58.24-B. The incinerator shall not be directly flue-fed nor shall any floor discharging chute directly connect with the combustion chamber.

(b) All laundry chutes shall discharge into laundry rooms or laundry collecting rooms, which are used for no other purpose and are enclosed as specified in Tables 58.24-A and 58.24-B.

(2) **SPRINKLER PROTECTION.** All rubbish chutes or laundry chutes, including pneumatic rubbish and laundry systems, shall be provided with automatic sprinkler protection specified in s. ILHR 51.23.

(3) **FIRE DAMPERS.** Fire dampers are required where chutes penetrate 2-hour or better fire-rated floor or wall systems in a horizontal run.

History: Cr. Register, December, 1981, No. 312, eff. 1-1-82; am. (1) (a) and (b), Register, October, 1982, No. 322, eff. 11-1-82; am. (1) (intro.), Register, December, 1983, No. 336, eff. 1-1-84.

ILHR 58.26 Interior finish. (1) **SCOPE.** The requirements of this section apply to the interior finishes and surfaces of a building. **FP**

Note: See s. ILHR 51.06 for specific requirements pertaining to foam plastics.

(2) **WALLS AND CEILINGS.** (a) *Materials.* Except as provided in par. (b), all walls and ceilings shall be Class A as specified in s. ILHR 51.01 (75a).

Note: See ch. Ind 4 for interior finish for elevator cabs.

(b) *Exceptions.* 1. Walls and ceilings of individual rooms having a capacity of not more than 4 persons may have a Class B interior finish as specified in s. ILHR 51.01 (75a).

2. Interior finish not in excess of 10 percent of the aggregate wall and ceiling areas of any room or space may be Class C materials in occupancies where interior finish of Class A or Class B is required.

(c) *Napped, tufted and looped materials.* Materials such as carpeting having a napped, tufted, looped, or similar surface, when applied on walls or ceilings, shall meet the requirements of Class A interior finish.

(3) **FLOORS.** All interior finishes of floor materials shall be Class I or better as specified in s. ILHR 51.01 (75a).

(a) *Tongue and groove wood flooring.* Tongue and groove wood flooring, one-half inch thick or greater, shall be permitted.

(b) *Floor material.* Floor material such as carpeting, shall be fire tested with the underlayment used and shall comply with the requirements as specified in ASTM E648-78, Test for Criteria Radiant Flux of Floor Covering Systems Using a Radiant Heat Source.

(4) **FIRE RETARDANT PAINTS OR SOLUTIONS.** Fire retardant paints or surface applied solutions shall not be used to satisfy the requirements of this section.

History: Cr. Register, December, 1981, No. 312, eff. 1-1-82; r. and recr. (2), Register, December, 1983, No. 336, eff. 1-1-84.

ILHR 58.27 Detection, alarm and communication systems. (1) **GENERAL.** All required detection and signaling devices and systems shall comply with the requirements of this section. **FP**

(a) All such systems shall be tested at least once a week and a record of such tests shall be kept. All system components or equipment shall be restored to normal condition promptly after each test or alarm and shall be maintained in an operable condition.

(b) The system shall be so arranged that the operation of any one station will actuate all devices connected to the system.

(c) A signaling system may be arranged to automatically perform local, incidental control functions to make the premises safer in the event of fire or to make it possible to hear alarm signals. The performance of incidental control functions, such as the release of self-opening or self-closing doors, shutting off supplies of gas, fuel oil, or electrical power, switching on emergency lights, switching off air supply ventilating fans, and other similar functions, shall not in any way impair the effective response of all required alarm indicating devices. The performance of incidental control functions shall not interfere with the power for lighting or for operating elevators.

(2) **FIRE ALARMS.** Every building shall have a manually operated fire alarm system as specified in s. ILHR 51.24 and shall comply with the following requirements:

(a) The operation of any fire alarm activating device shall automatically, without delay, accomplish general alarm indication and control functions as specified in sub. (1). Zoned, coded systems may be used.

(b) The fire alarm system shall be arranged to transmit an alarm automatically to the fire department required to serve the area in which the health care facility is located, by the most direct and reliable method approved by local regulations.

(3) **AUTOMATIC SMOKE DETECTION SYSTEM.** (a) Except as provided in par. (b), an approved automatic smoke detection system shall be installed in all corridors in nursing homes. Such systems shall be installed and maintained as specified in NFPA 72E but in no case shall smoke detectors be spaced more than 30 feet apart on center or more than 15 feet from any wall. All automatic smoke detection systems required by this section shall be electrically interconnected to the fire alarm system.

(b) Corridor smoke detection systems are not required on the patient sleeping room floors, where each patient sleeping room is protected by an approved smoke detection system.

(4) **FIRE EXTINGUISHERS.** Portable fire extinguishers shall be provided and maintained as specified in s. ILHR 51.22.

History: Cr. Register, December, 1981, No. 312, eff. 1-1-82; am. (3) (a), Register, December, 1983, No. 336, eff. 1-1-84.

FP ILHR 58.28 Standpipes. (1) **FIRST-AID STANDPIPES.** First-aid standpipes shall be provided as specified in s. ILHR 51.21 for all health care facilities, unless an approved automatic sprinkler system is installed.

(2) **FIRE DEPARTMENT STANDPIPES.** Fire department standpipes shall be provided in all buildings exceeding 60 feet in height and shall comply with the requirements specified in s. ILHR 51.21.

History: Cr. Register, December, 1981, No. 312, eff. 1-1-82.

Register, August, 1985, No. 356

ILHR 58.29 Automatic sprinkler and other suppression systems. Automatic sprinkler systems shall comply with the requirements specified in s. ILHR 51.23, except as modified in this section.

(1) **WHERE REQUIRED.** (a) *Hospitals.* Automatic sprinkler systems shall be provided as specified in ss. ILHR 52.01 and 58.24.

(b) *Nursing homes.* 1. A complete automatic fire sprinkler system shall be provided in all nursing homes constructed after the effective date of this rule.

2. Additions to existing nursing homes shall be provided with a complete automatic fire sprinkler system. The sprinkler protection shall be provided throughout unless the addition is separated from the existing building by at least 2-hour fire-resistive construction in which case only the addition shall be protected by an automatic fire sprinkler system.

(2) **SPRINKLER CONTROL VALUES.** (a) The main sprinkler control valves shall be electrically supervised so that at least a local alarm will sound at a constantly supervised location when the valve is closed.

(b) All valves other than the main sprinkler control valve shall be electrically supervised or secured with a key locking device.

(3) **WATER FLOW SWITCH.** The water flow alarm switch for the automatic sprinkler system shall be electrically interconnected with the fire alarm system.

(4) **PARTIAL AUTOMATIC SPRINKLER SYSTEM.** The sprinkler piping serving no more than 6 sprinklers for any isolated hazardous area, may be connected directly to a domestic water supply system having a capacity sufficient to provide 0.15 gallons per minute per square foot of floor area throughout the entire enclosed area.

(a) *Indicating shut-off valve.* An indicating shut-off valve shall be installed in an accessible location between the sprinklers and the connection to the domestic water supply.

(b) *Water flow detection.* Where more than 2 sprinklers are installed in a single area, water flow detection shall be provided to sound the building fire alarm system in the event of sprinkler operation.

(5) **OTHER AUTOMATIC SUPPRESSION SYSTEMS.** (a) *Types.* Other automatic suppression systems such as, but not limited to, carbon dioxide, dry chemical, foam and Halon 1301, may be installed in lieu of an automatic water sprinkler system in any occupancy where the extinguishment or control of fire may be more effectively accomplished by this type of automatic suppression system.

(b) *Activation.* These suppression systems shall be installed such that the fire alarm system will sound when the suppression system is activated.

History: Cr. Register, December, 1981, No. 312, eff. 1-1-82; am. (2) (a), Register, December, 1983, No. 336, eff. 1-1-84; am. (1) (b), Register, August, 1985, No. 356, eff. 1-1-86.

ILHR 58.30 Smoke barrier. (1) **DEFINITION.** A smoke barrier is a separation wall which is continuous from outside wall to outside wall and from floor slab to the underside of the floor slab or roof slab above, including all concealed spaces such as those found above a ceiling including interstitial spaces.

(2) **FIRE-RESISTIVE RATING.** Smoke barriers shall have a one-hour fire-resistive rating specified in s. ILHR 51.043.

(3) **WHERE REQUIRED.** Smoke barriers are required to:

(a) Limit the area on any story to a length and width of not more than 150 feet;

(b) Divide every story into at least 2 compartments; and

(c) Enclose elevator lobbies on each floor.

(4) **DOORS.** (a) Corridor openings in smoke barriers shall be protected by a pair of swinging doors, each door to swing in a direction opposite from the other. Each door shall have a minimum width of 44 inches, except corridor openings in areas not intended for the housing, treatment, or use of patients may be protected by a single door having a minimum width of 36 inches.

(b) Doors in smoke barriers shall be self-closing and have at least a 20 minute fire-resistive rating, except doors may be held open as specified in s. ILHR 58.21.

(c) Door louvers and grills are prohibited. Doors may be undercut to a maximum of $\frac{3}{4}$ inches.

(d) A vision panel complying with the requirements of s. ILHR 51.048 and not exceeding 1,296 square inches in area, shall be provided in each door in a smoke barrier and shall be set in steel frames. The bottom of the vision panel shall be located not more than 40 inches off the floor.

(e) Rabbets, levels, or astragals are required at the meeting edges, and stops are required on the head and sides of door frames. Positive latching hardware is not required.

(f) Center mullions are prohibited.

(5) **DAMPERS.** An approved damper designed to resist the passage of smoke shall be provided at each point a duct penetrates a smoke barrier. The damper shall close upon detection of smoke by an approved smoke detector, located within the duct except that:

(a) The approved damper, if located above a smoke barrier door, may be arranged to close upon detection of smoke by the local device designed to detect smoke on either side of the smoke barrier door opening.

(b) Buildings designed with an engineered smoke control system as specified in NFPA 90A, Standard for the Installation of Air Conditioning and Ventilating Systems, need not comply with this requirement.

(6) **VISION PANELS.** (a) Except as provided in par. (b), fixed wire glass vision panels shall be permitted in smoke barrier walls, provided the vision panels do not exceed 1,296 square inches in area. The vision panels shall have bolted steel frames and the glazing material shall be listed by an approved testing laboratory.

(b) Vision panels shall not be restricted in area and in fire resistance of glass or frames in buildings equipped throughout with an approved automatic extinguishing system.

ILHR 58.31 Construction of corridor walls. (1) FIRE-RESISTIVE RATING. Except as otherwise provided in this section, corridors shall be separated from all other areas by partitions which are continuous from the floor slab to the underside of the roof or floor slab above, through any concealed spaces such as those above suspended ceilings, and through interstitial structural and mechanical spaces, and shall have at least a one-hour fire-resistive rating as specified in s. ILHR 51.043.

(a) In health care facilities equipped throughout with an approved automatic extinguishing system, a corridor may be separated from all other areas by nonfire-rated partitions, and where suspended ceilings are provided, the partitions may be terminated at the suspended ceiling.

(b) Corridor partitions may terminate at ceilings which are not an integral part of a floor construction if there is at least 5 feet of space between the top of the ceiling subsystem and the bottom of the floor or roof above provided:

1. The ceiling is of membrane type with a finish rating of 15 minutes;
2. Corridor partitions form smoke-tight joints with the ceilings (joint filler, if used, must be noncombustible);
3. Each compartment of interstitial space which constitutes a separate smoke area is vented, in case of smoke emergency, to the outside by mechanical means having a capacity to provide at least 2 air changes per hour, but in no case having a capacity less than 5,000 cfm;
4. The interstitial space shall not be used for storage; and
5. The space shall not be used as a plenum for supply, exhaust or return air except as provided in subd. 3.

(c) Waiting areas on a patient sleeping floor may be open to the corridor, provided:

1. The area does not exceed 250 square feet;
2. The area is located to permit direct supervision by the facility staff;
3. The area is equipped with an electrically supervised automatic smoke detection system installed as specified in s. ILHR 58.27; and
4. Not more than one such waiting area is permitted in each smoke compartment.

(d) Waiting areas on floors other than institutional sleeping floor may be open to the corridor, provided:

1. Each area does not exceed 600 square feet;
2. The area is located to permit direct supervision by the facility staff;
3. The area is arranged not to obstruct any access to required exits;
4. The area is equipped with an electrically supervised, automatic smoke detection system installed as specified in s. ILHR 58.27.

(e) Buildings equipped throughout with an approved automatic sprinkler system may have spaces open to the corridor which are unlimited in size provided:

1. The spaces are not used for patient sleeping rooms, treatment rooms or hazardous areas;

2. Each space is located to permit direct supervision by the facility staff;

3. The space and corridors which the space opens onto in the same smoke compartment are protected by an electrically supervised automatic smoke detection system installed as specified in s. ILHR 58.27; and

4. The space is arranged not to obstruct access to required exits.

(f) Space for doctors' and nurses' charting, communications, and related clerical areas may be open to the corridor.

(2) VISION PANELS. (a) Fixed wire glass vision panels shall be permitted in corridor walls provided they do not exceed 1,296 square inches in area and comply with the requirements specified in s. ILHR 51.048.

(b) Vision panels shall not be restricted in area and in fire resistance of glass or frames in buildings equipped throughout with an approved automatic extinguishing system.

(3) DOORS. Except as otherwise provided in this subsection, doors protecting corridor openings, other than required enclosures of exits or hazardous areas, shall have a 20-minute fire-resistive rating and be provided with latches. Fixed wire glass vision panels installed in these doors shall not exceed 720 square inches in area and shall be mounted in approved steel frames.

(a) In buildings equipped with a complete approved automatic sprinkler system:

1. Such doors and frames are not required to have a fire-resistive rating, but shall be constructed to resist the passage of smoke;

2. Such doors are provided with latches of a type suitable for keeping the door tightly closed; and

3. There is no restriction on the area of vision panels in these doors, the vision panels do not need to be wired, and there is no restriction in the type of frames.

(b) Door closing devices are not required on doors in corridor wall openings, other than those exits or required enclosures of hazardous areas.

(c) Labeled door frames are not required on openings other than those serving exits or required enclosures of hazardous areas, providing the door frames and stops are of steel construction.

(d) Doors to toilet rooms, bathrooms, shower rooms, sink closets, and similar auxiliary spaces which do not contain flammable or combustible materials need not comply with this section.

(4) **TRANSFER GRILLS.** Transfer grills shall not be used in these walls or doors, except doors to toilet rooms, bathrooms, shower rooms, sink closets and similar auxiliary spaces which do not contain hazardous quantities of flammable or combustible materials may have ventilating louvers or may be undercut.

History: Cr. Register, December, 1981, No. 312, eff. 1-1-82.

SANITARY FACILITIES

ILHR 58.32 Sanitation requirements. (1) **TOILET ROOMS.** Every building included under the scope of this subchapter shall be provided with separate toilet rooms for each sex, and shall comply with the requirements specified in this section and ss. ILHR 52.50 to 52.62.

(2) **PATIENTS.** The number of fixtures required for each sex shall comply with the ratios specified in Table 58.32.

(3) **EMPLOYEES.** The number of fixtures for employes shall comply with the requirements specified in Table 54.12-B and s. ILHR 52.04 (4) and (8).

(4) **GENERAL PUBLIC.** The number of fixtures for the general public shall comply with the requirements specified in Table 54.12-A and s. ILHR 52.04 (4) and (8).

Note: See ch. H 24—General and Special Hospitals, and ch. HSS 132—Nursing Homes, for special requirements and locations for water closets, lavatories and bathing facilities.

TABLE 58.32

Type of Occupancy	Type of Fixture			
	Water Closets (WC)	Lavatories (L)	Bathtubs or Showers	Drinking Facilities (DF)
Health Care Facilities	1 (WC) per 2 patient rooms and not more than 4 beds	1 (L) per 2 patient rooms, not more than 4 persons per (L)	Nursing Homes 1 for each 20 persons or fraction thereof Hospitals 1 for each 15 patients or fraction thereof	1 (DF) for each 100 persons

History: Cr. Register, December, 1981, No. 312, eff. 1-1-82.

Subchapter II — Detention and Correctional Facilities

SCOPE

ILHR 58.40 Scope. The requirements of this subchapter shall apply to all detention and correctional facilities, constructed on or after the effective date of this subchapter.

History: Cr. Register, December, 1981, No. 312, eff. 1-1-82.

ILHR 58.41 Definitions. For the purpose of this subchapter, the following terms are defined:

(1) "Borrowed light" means an opening in an interior partition which provides natural light to an interior space.

(2) "Dayroom" means any room used as a group activity space and located contiguous to the sleeping rooms.

(3) "Detention and correctional facilities" means any building or part of a building used for purposes such as jails, detention centers, correctional institutions, reformatories, houses of correction, pre-release centers, and other residential care facilities where occupants are forcibly confined.

(4) "Holding room" means any room used for confining persons for a maximum of 72 hours for the purpose of booking, court appearances and similar type functions.

(5) "Program support facility" means any detention or correctional facility, other than sleeping areas, containing only those facilities such as schools, theaters, assembly halls, shops, gyms, offices, medical facilities, food service and dining facilities, laundries, gatehouses and other similar facilities, where the occupancy of these areas is primarily residents or detention staff or both.

(6) "Smoke barrier" means a separation wall which extends continuously from outside wall to outside wall and from the floor to the underside of the floor slab or roof slab above, including all concealed spaces such as those found above a ceiling including interstitial spaces.

(7) "Smoke compartment" means a space within a building enclosed by smoke barriers on all sides.

(8) "Security vestibule" means a compartment provided with 2 or more doors with the intended purpose to prevent the continuous and unlimited passage by allowing the release of only one door at a time.

History: Cr. Register, December, 1981, No. 312, eff. 1-1-82; am. (4), Register, December, 1983, No. 336, eff. 1-1-84.

GENERAL REQUIREMENTS

ILHR 58.42 Class of construction. (1) BUILDINGS OR PORTIONS OF BUILDINGS WITH SLEEPING ROOMS. All detention and correctional facilities containing sleeping facilities or holding rooms or both shall be at least type 2 construction as specified in s. ILHR 51.03.

(2) PROGRAM SUPPORT FACILITIES. All program support facilities shall be constructed in accordance with the following:

(a) *One-story building.* All buildings one-story in height shall be at least type 6, totally non-combustible construction as specified in s. ILHR 51.03.

(b) *Two-stories or more in height.* All buildings 2-stories or more in height shall be at least type 2 construction as specified in s. ILHR 51.03.

History: Cr. Register, December, 1981, No. 312, eff. 1-1-82; am. (1), Register, December, 1983, No. 336, eff. 1-1-84.

ILHR 58.43 Program support facilities. All program support facilities shall comply with the specific occupancy chapter requirements as specified in chs. ILHR 54 to 62, except as modified in ss. ILHR 58.59 and 58.64.

History: Cr. Register, December, 1981, No. 312, eff. 1-1-82.

Register, August, 1985, No. 356

ILHR 58.44 Separation from other occupancies. (1) **OCCUPANCY SEPARATION.** Occupancies not within the scope of this subchapter, built in connection with any detention or correctional facility shall be separated from any such detention or correctional facility by at least 2-hour fire-resistive rated construction as specified in s. ILHR 51.04. Auditoriums, chapels, dining rooms, residential facilities and other similar areas provided for the residents need not be separated with rated construction. Class of construction separations shall comply with s. ILHR 51.02 (20).

(2) **GARAGES.** (a) Storage garages and repair garages shall be separated from detention and correctional facilities as specified in s. ILHR 59.22.

(b) Areas accommodating vehicles for the purpose of loading or unloading persons or material need not be separated from detention and correctional facilities. Storage or repair of the vehicles is prohibited in the loading and unloading areas, unless the type of construction meets the requirements for a garage.

(3) **PROTECTION OF OPENINGS.** All openings in occupancy separations shall be protected by fire-resistive door assemblies as specified in s. ILHR 58.60.

(4) **EXITING FROM MIXED OCCUPANCIES.** Required means of egress from all detention and correctional occupancies may exit through non-detention and non-correctional occupancies provided the means of egress complies with the requirements specified in this subchapter.

History: Cr. Register, December, 1981, No. 312, eff. 1-1-82; am. (2) (a), Register, October, 1982, No. 322, eff. 11-1-82; am. (3), Register, December, 1983, No. 336, eff. 1-1-84; cr. (4), Register, August, 1985, No. 356, eff. 1-1-86.

ILHR 58.45 Windows. (1) **NATURAL LIGHTING.** Every sleeping room, except holding rooms where residents are detained for a time period not to exceed 72 hours, shall be provided with natural light. The natural light may be provided directly to the sleeping room by windows or sky lights or may be transferred indirectly to the space through the use of borrowed lights. The natural light shall be provided through either clear or translucent glazing with the area of the sash being at least 8% of the floor area served.

(2) **VENTILATION.** Every sleeping room shall be provided with ventilation in accordance with one of the following:

(a) Windows or skylights with an openable area not less than 4% of the floor area served and located within the sleeping room; or

(b) Mechanical ventilation as specified in s. ILHR 64.58 (2) and provided with an emergency source of power.

History: Cr. Register, December, 1981, No. 312, eff. 1-1-82; am. (1), Register, October, 1982, No. 322, eff. 11-1-82.

ILHR 58.46 Size of sleeping rooms. Every sleeping room shall provide at least 400 cubic feet of space for each occupant.

History: Cr. Register, December, 1981, No. 312, eff. 1-1-82.

ILHR 58.47 Sleeping rooms below grade. All buildings having sleeping rooms below grade shall be designed and constructed to prevent penetration or collection of moisture within occupied spaces.

History: Cr. Register, December, 1981, No. 312, eff. 1-1-82.

MEANS OF EGRESS REQUIREMENTS

FP ILHR 58.48 Required means of egress. (1) GENERAL REQUIREMENTS. All required means of egress doors shall comply with s. ILHR 51.15, except as modified in this section and s. ILHR 58.59.

(2) **DOORS IN MEANS OF EGRESS.** (a) Doors in a means of egress may be of the horizontal sliding type, providing the force to slide the door to its fully open position does not exceed 37 pounds.

(b) A door which serves an area with a capacity not more than 25 persons is not required to open in the direction of egress.

(3) **EXIT DISCHARGE.** Exit discharge may terminate at one of the following:

(a) Directly at the exterior of the building;

(b) At a horizontal exit; or

(c) Into a fenced or walled court, provided that not more than 2 walls of the court are the walls of the building from which exit is being made. Enclosed yards or courts shall be sized to accommodate all occupants, a minimum of 30 feet from the building with a net area of 15 square feet per person. Access from the fenced or walled court to the public thoroughfare may be fenced and locked.

(4) **EXIT ACCESS.** A dayroom may serve as a portion of the exit access from a sleeping room.

History: Cr. Register, December, 1981, No. 312, eff. 1-1-82.

FP ILHR 58.49 Exit doors, number and type of exits. (1) NUMBER. At least 2 exits shall be accessible from each floor of the building and shall be located such that in case any exit is blocked, some other exit will still be accessible.

(2) **EXIT DOORS.** All exit doors shall be at least 36 inches in width.

(3) **EXIT ACCESS DOORS.** All exit access doors shall be at least 36 inches in width, except for the following modifications:

(a) Doors to sleeping rooms shall be at least 28 inches in width;

(b) Doors to sleeping rooms designated for use by the physically disabled shall be at least 32 inches in width; or

(c) Doors to dayrooms shall be at least 32 inches in width.

(4) **TYPE OF EXITS.** (a) Required exits shall be by a door leading directly to a stairway, smokeproof tower, ramp, horizontal exit, exit passageway or outside the building as specified in this subchapter. No more than one-half of the required exits may be horizontal exits.

(b) Where a detention or correctional facility, other than a hospital or nursing home, is located on the upper floors of a building having a different occupancy, at least one of the exits from the detention or correctional facility shall be a separate smokeproof tower as specified in s. ILHR 51.17. The smokeproof tower shall serve only the detention or correc-

tional facility and there shall be no doors opening into the smokeproof tower from any other occupancy of the building.

History: Cr. Register, December, 1981, No. 312, eff. 1-1-82.

ILHR 58.50 Stairways. (1) **GENERAL.** (a) All required exit stairways shall comply with the requirements specified in s. ILHR 51.16 and shall be enclosed as specified in s. ILHR 51.18. **FP**

(b) 1. Except as provided in subd. 2., stairways in addition to those required by this chapter need not lead to the outside but shall be enclosed as required in par. (a).

2. Nonrequired stairways serving open mezzanines need not be enclosed.

(2) **STAIRWAY TERMINATION.** Stairways provided in addition to those required by this subchapter shall be enclosed as specified in s. ILHR 51.18 but need not lead to the outside. A sign or label shall be posted on the doors of the stair enclosures and shall bear the following: "Not an Exit".

History: Cr. Register, December, 1981, No. 312, eff. 1-1-82; am. Register, December, 1983, No. 336, eff. 1-1-84; am. (1) (a) and cr. (1) (b), Register, August, 1985, No. 356, eff. 1-1-86.

ILHR 58.51 Smokeproof towers. Smokeproof stair towers shall comply with the requirements specified in ss. ILHR 51.17 and 58.48. **FP**

History: Cr. Register, December, 1981, No. 312, eff. 1-1-82.

ILHR 58.52 Horizontal exits. (1) **GENERAL.** Horizontal exits shall comply with the requirements in s. ILHR 51.19, except as modified in this section.

(2) **AREA.** At least 6 net square feet of accessible space per occupant shall be provided on each side of the horizontal exit for the total number of people in the adjoining compartment.

(3) **DOORS.** (a) A single door used as a horizontal exit shall serve one direction only, be at least 36 inches wide and swing in the direction of egress.

(b) Horizontal exit doors may be locked as specified in s. ILHR 58.59.

(4) **RESTRICTIONS.** If a horizontal exit is used as a smoke barrier, it shall comply with s. ILHR 58.67.

History: Cr. Register, December, 1981, No. 312, eff. 1-1-82.

ILHR 58.53 Ramps. (1) **MINIMUM WIDTH.** (a) *Interior ramps.* Interior ramps shall be a minimum of 44 inches wide, of which not more than 4 inches on each side may be occupied by a handrail.

(b) *Exterior ramps.* Exterior ramps shall be a minimum of 48 inches wide, of which not more than 4 inches on each side may be occupied by a handrail.

(2) **SLOPE.** Ramps shall have a slope of not more than one foot of rise in 8 feet of run, except ramps providing access for the disabled shall comply with s. ILHR 52.04 (7).

(3) **ENCLOSURE.** Ramps used as a required means of egress shall comply with the enclosure requirements for stairways in s. ILHR 51.18.

(4) **LANDINGS AND PLATFORMS.** (a) If a door is provided at the top or bottom or both of a ramp, a landing or platform shall be placed between the door and the ramp regardless of the direction of swing of the door.

(b) Every landing or platform shall be at least as wide as the ramp, measured at right angles to the direction of travel. The length of every landing or platform shall be at least as wide as the ramp, but need not exceed 48 inches.

History: Cr. Register, December, 1981, No. 312, eff. 1-1-82; cr. (4), Register, December, 1983, No. 336, eff. 1-1-84.

ILHR 58.54 Required exit width. (1) **OCCUPANT LOAD.** The occupant load for which means of egress shall be provided shall be the maximum number of persons occupying that floor, but not less than one person for each 120 sq. ft. gross floor area.

(2) **REQUIRED EXIT WIDTH.** The required exit width shall comply with s. ILHR 51.15 (6).

History: Cr. Register, December, 1981, No. 312, eff. 1-1-82.

ILHR 58.55 Arrangement of means of egress. (1) **SLEEPING ROOM.** Every sleeping room shall have a door leading directly to an exit access, except where an exit door opens directly to the outside from the room at the ground level.

(2) **CORRIDOR ACCESS.** (a) Every aisle, corridor and hallway shall provide access to at least 2 exits complying with s. ILHR 58.48.

(b) Every aisle, corridor and hallway used for exit access shall be at least 44 inches in clear and unobstructed width.

(3) **EXIT PASSAGEWAYS.** Every exit passageway shall be at least 44 inches in width.

(4) **AREA EXITING.** Any room, suite of rooms, space or area accommodating 25 persons or more, shall have at least 2 exit access doors distributed to provide the best possible means of egress from the room.

(5) **SECURITY VESTIBULE EXITING.** A security vestibule may be permitted in a means of egress where there are provisions for continuous and unobstructed passage through the security vestibule during an emergency exit condition.

(6) **DEAD END CORRIDOR.** Every exit or exit access shall be so arranged that no corridor, aisle or passageway has a pocket or dead end exceeding 30 feet.

History: Cr. Register, December, 1981, No. 312, eff. 1-1-82; cr. (6), Register, August, 1985, No. 356, eff. 1-1-86.

ILHR 58.56 Measurement of travel distance to exits. All exits in detention and correctional facilities shall be located to provide means of egress remote from one another.

(1) **EXIT ACCESS TO AN EXIT.** Travel distance shall be measured along passageways. The distance between any room door required as an exit access and an exit shall not exceed 100 feet, except that in buildings protected with a complete automatic sprinkler system the distance shall not exceed 150 feet.

Register, August, 1985, No. 356

(2) **ROOM TO AN EXIT.** Travel distance shall be measured along passageways. The distance between any point in a room and an exit shall not exceed 150 feet, except that in buildings protected with a complete automatic sprinkler system the distance shall not exceed 200 feet.

(3) **SLEEPING ROOM TO AN EXIT ACCESS.** Travel distance shall be measured along passageways. The distance between any point in a sleeping room or suite and an exit access door to that room or suite shall not exceed 50 feet.

History: Cr. Register, December, 1981, No. 312, eff. 1-1-82.

ILHR 58.57 Illumination of means of egress. (1) **ILLUMINATION.** Artificial lighting shall be provided at all exits and for such period of times as required to maintain safe exiting.

(2) **ILLUMINATION LEVEL.** The floors of means of egress shall be illuminated at all points including angles and intersections of corridors and passageways, stairs, landings of stairs and exit doors to values specified in ch. Ind 19.

History: Cr. Register, December, 1981, No. 312, eff. 1-1-82.

ILHR 58.575 Emergency lighting. Emergency lighting complying with the requirements specified in ch. ILHR 16 shall be required when 20 or more resident beds are provided. **FP**

History: Cr. Register, December, 1983, No. 336, eff. 1-1-84.

ILHR 58.58 Marking of means of egress. (1) **EXIT SIGNS.** Every required exit shall be identified with an internal illuminated, red exit sign bearing the word "EXIT" or "OUT" in plain letters not less than 6 inches high, with the principal strokes of the letter not less than 3/4 inches. **FP**

(2) **DIRECTIONAL SIGNS.** An illuminated sign, not less than 6 inches high, reading "EXIT" or similar designation, with an arrow indicating the direction, shall be placed in every location where the direction of travel to reach the nearest exit is not immediately apparent.

(3) **OBSTRUCTIONS.** (a) Decorations, furnishings or equipment which impair visibility of an exit sign shall not be permitted. Displays, objects in or near the line of vision to the required exit sign, or brightly illuminated signs used for purposes other than exits shall not be permitted so as to detract attention from the exit sign.

(b) Hangings or draperies shall not be placed over exit doors or be located as to conceal or obscure any exit. Mirrors shall not be placed on exit doors. Mirrors shall not be placed in or adjacent to any exit in such a manner as to confuse the direction of exit.

(4) **SPECIAL SIGNS.** Any door, passage, or stairway which is neither an exit nor a way of exit access, and which is located or arranged that it may be mistaken for an exit, shall be identified by a sign indicating it is not an exit.

History: Cr. Register, December, 1981, No. 312, eff. 1-1-82.

ILHR 58.59 Door locks. All doors in detention and correctional facilities having locking devices shall comply with the following requirements: **FP**

(1) **LOCKING OF MEANS OF EGRESS DOORS.** All doors in detention and correctional facilities may be locked in accordance with this section, providing that staff is on duty 24 hours a day.

(a) *Locks at sleeping rooms.* 1. Single sleeping room. A single sleeping room may be key locked.

2. Two or more sleeping rooms. Where 2 or more sleeping rooms within a smoke compartment are locked, a remote locking and unlocking device shall be provided. The remote locking and unlocking device shall be located outside of the sleeping room areas.

(b) *Locks at exterior doors, stairways and horizontal exits.* Doors from the secured areas to the exterior of the building, into stairway enclosures or at horizontal exits may be locked with a key lock. The keys to unlock such doors shall be maintained and available at the facility at all times and the locks shall be operable from the outside.

(2) **REMOTE RELEASE.** All remote release operated doors shall be provided with a back-up means of operation as follows:

(a) Power-operated sliding doors or power operated locks shall be so constructed that in the event of power failure a manual mechanical means to release and open the doors is provided at each door and either emergency power in accordance with ch. ILHR 16 is provided for the power operation or a remote manual mechanical release is provided.

(b) Mechanically operated sliding doors or mechanically operated locks shall be provided with a manual mechanical means to release and open the door at the door.

(3) **REMOTE UNLOCKING.** Doors remotely unlocked under emergency conditions shall not automatically relock when closed unless specific action is taken at the remote location to enable doors to relock.

(4) **STANDBY EMERGENCY POWER.** Standby emergency power shall be provided for all electrically power-operated doors and power-operated locks. Power shall be arranged to automatically operate upon failure of normal power within 10 seconds and to maintain the necessary power source for at least 1½ hours.

History: Cr. Register, December, 1981, No. 312, eff. 1-1-82; am. (1) (b), Register, December, 1983, No. 336, eff. 1-1-84; r. and recr. (2), Register, August, 1985, No. 356, eff. 1-1-86.

PROTECTION

FP ILHR 58.60 Protection of openings. (1) **DOORS.** Doors protecting openings in occupancy separations, smoke barriers, or horizontal exits shall be self-closing fire-resistive door assemblies as specified in s. ILHR 51.047.

(2) **CLOSING DEVICE.** Doors protecting such openings shall be equipped with a closing device and shall normally be kept closed, except the doors may be held open by a hold open device actuated by products of combustion other than heat. The closing device shall be arranged such that the activation of any of the following systems will initiate the self-closing action of all such doors:

(a) Manual fire alarm systems;

- (b) Automatic smoke detection systems;
- (c) Fire detection systems; or
- (d) Automatic sprinkler systems.

History: Cr. Register, December, 1981, No. 312, eff. 1-1-82; am. (2) (intro.), Register, December, 1983, No. 336, eff. 1-1-84.

ILHR 58.61 Protection of vertical openings. Every elevator shaft, dumb-waiter shaft, laundry chute, wastepaper chute, pipe shaft, rubbish chute and other similar vertical shafts in buildings shall be enclosed with at least 2-hour fire-resistive construction as specified in s. ILHR 51.043. All openings shall be protected with fire-resistive door assemblies as specified in s. ILHR 51.047. **FP**

History: Cr. Register, December, 1981, No. 312, eff. 1-1-82; am. Register, December, 1983, No. 336, eff. 1-1-84.

ILHR 58.62 Isolation of hazards. (1) **ENCLOSURES.** All hazards shall be enclosed from other areas of the building with fire-resistive rated construction and specified in Table 58.62. **FP**

(2) **OPENINGS.** (a) All openings into boiler, furnace and emergency generator enclosures shall be protected with self-closing fire-resistive door assemblies as specified in s. ILHR 51.047.

(b) All openings into other hazard enclosures shall be protected with fire-resistive door assemblies as specified in ss. ILHR 51.047 and 58.60 (2).

TABLE 58.62

HAZARDS	FIRE-RESISTIVE RATING IN HOURS	
	Buildings 3 Stories or Less ¹	Buildings Over 3 Stories
Boiler (including fuel room and breeching)	2	3
Furnace (including fuel room and breeching)	2	3
Emergency generators (cannot be located in boiler or furnace rooms)	2	3
Laundries (having gas or open flame equipment)	2	3
Kitchens (commercial type)	2	3
Handicraft shops	2	3
Carpenter shops	2	3
Repair shops	2	3
Paint shops	2	3
Trash Collection	2	3
Storage rooms (containing quantities of flammable or combustible material not exceeding 1 lb. of material per square foot of floor area)	2	3

¹The minimum hourly ratings specified may be reduced by one hour in buildings less than 3 stories in height and protected by a complete automatic fire sprinkler system. The minimum rating shall not be less than one hour.

History: Cr. Register, December, 1981, No. 312, eff. 1-1-82; r. and rec. Table, am., Register, December, 1983, No. 336, eff. 1-1-84.

FP ILHR 58.63 Standpipes. (1) **FIRST-AID STANDPIPES.** First-aid standpipes shall be provided as specified in s. ILHR 51.21 for all detention and correctional facilities, unless an approved automatic sprinkler system is installed.

(2) **FIRE DEPARTMENT STANDPIPES.** Fire department standpipes shall be provided in all buildings exceeding 60 feet in height and shall comply with s. ILHR 51.21.

History: Cr. Register, December, 1981, No. 312, eff. 1-1-82.

FP ILHR 58.635 Fire extinguishers. Portable fire extinguishers shall be provided and maintained as specified in s. ILHR 51.22.

History: Cr. Register, December, 1983, No. 336, eff. 1-1-84.

FP ILHR 58.64 Fire alarms. All detention and correctional facilities shall have a manually operated fire alarm system as specified in s. ILHR 51.24, except as modified in this section.

(1) **MANUAL FIRE ALARM BOXES.** Manual fire alarm boxes may be locked, providing all staff carry the key which will unlock the fire alarm box.

Register, August, 1985, No. 356

(2) **LOCATION OF MANUAL FIRE ALARM BOXES.** Manual fire alarm boxes may be located at staff locations in lieu of being located at exits and stairways.

History: Cr. Register, December, 1981, No. 312, eff. 1-1-82.

ILHR 58.65 Automatic smoke detection system. (1) **LOCATION.** An approved automatic smoke detection system shall be installed in all sleeping rooms, holding rooms and in all corridors in connection with the sleeping room areas. Such systems shall be installed in accordance with NFPA 72E but in no case shall smoke detectors be spaced more than 30 feet apart on center or more than 15 feet from any wall, except as provided in sub. (2). All automatic smoke detection systems required by this section shall be electrically interconnected to the fire alarm system. **FP**

(2) **EXCEPTION.** Other arrangements and positioning of smoke detectors may be used to prevent damage or tampering or for other purposes provided the function of detecting any fire is fulfilled. This may include the location of detectors in exhaust ducts from sleeping rooms, behind grills, or in other locations.

Note: See s. ILHR 52.015 for requirements pertaining to automatic fire sprinkler systems for detention and correctional facilities.

History: Cr. Register, December, 1981, No. 312, eff. 1-1-82; am. (1), Register, December, 1983, No. 336, eff. 1-1-84.

ILHR 58.66 Interior finishes. (1) **WALLS AND CEILINGS.** Interior finish of walls and ceilings in corridors, exits and any space not separated from exit access corridors and exits by a partition capable of retarding the passage of smoke shall be Class A. All other areas shall be Class A, B or C as defined in s. ILHR 51.01 (75a). **FP**

(2) **FLOORS.** Interior floor finish in corridors and exits and any space not separated from exit access corridors and exits by a partition capable of retarding the passage of smoke shall be Class I as defined in s. ILHR 51.01 (75a).

History: Cr. Register, December, 1981, No. 312, eff. 1-1-82.

ILHR 58.67 Smoke barrier. (1) **FIRE-RESISTIVE RATING.** Smoke barriers shall have a one-hour fire-resistive rating as specified in s. ILHR 51.04. **FP**

(2) **WHERE REQUIRED.** Smoke barriers are required to:

(a) Divide every story used by residents for sleeping, and any other story having an occupant load of 50 or more persons, into at least 2 compartments;

(b) Limit the housing of a maximum of 175 residents in any smoke compartment; and

(c) Limit on any story the length and width of each smoke compartment to no more than 150 feet.

(3) **AREA.** At least 6 square feet of accessible area per occupant shall be provided on each side of the smoke barrier for the total number of occupants in adjoining compartments.

(4) **DOORS.** (a) Openings in smoke barriers shall be protected by doors at least 36 inches wide, and such doors shall swing in the direction of egress. Where egress may be in either direction, a pair of swinging doors

shall be provided where each door swings in a direction opposite from the other, except doors in a means of egress may be of the horizontal sliding type providing the force to slide the door to its fully open position does not exceed 37 lbs.

(b) Doors in smoke barriers shall have at least a 20 minute fire-resistive rating, except that doors may be held open as specified in s. ILHR 58.60.

(c) Louvers and grills in smoke barrier doors are prohibited. Doors may be undercut to a maximum of 3/4 inches.

(d) A vision panel, complying with s. ILHR 51.048 for wired glass and not exceeding 1,296 square inches and set in steel frames, shall be provided in each door in a smoke barrier.

(e) Rabbets, bevels, or astragals are required at the meeting edges of doors, and stops are required on the head and sides of door frames.

(5) **DAMPERS.** An approved damper designed to resist the passage of smoke shall be provided at each point a duct penetrates a smoke barrier. The damper shall close upon detection of smoke by an approved smoke detector, located within the duct except that:

(a) The approved damper, if located above a smoke barrier door, may be arranged to close upon detection of smoke by the local device designed to detect smoke on either side of the smoke barrier door opening; or

(b) Buildings designed with an engineered smoke control system as specified in NFPA 90A, Standard for the Installation of Air Conditioning and Ventilating Systems, need not comply with this requirement.

History: Cr. Register, December, 1981, No. 312, eff. 1-1-82; am. (4) (b), Register, December, 1983, No. 336, eff. 1-1-84.

SANITARY FACILITIES

ILHR 58.68 Sanitation requirements. (1) **TOILET ROOMS.** Every building included under the scope of this subchapter shall be provided with separate toilet rooms for each sex, and shall comply with the requirements specified in this section and ss. ILHR 52.52 to 52.62, except for the following modifications:

(a) Enclosure of fixtures as specified in s. ILHR 52.59 shall be required only for fixtures used by the staff or visitors, or both; or

(b) Water closet seats as specified in s. ILHR 52.60 (1) are not required on water closets used by residents in maximum security detention and correctional facilities.

(2) **RESIDENTS.** The number of fixtures required for each sex shall be determined in accordance with the ratios specified in Table 58.68.

(3) **EMPLOYEES.** The number of fixtures for employees shall be provided in accordance with the requirements specified in Table 54.12-B and s. ILHR 52.04 (4) and (8).

(4) **GENERAL PUBLIC.** The number of fixtures for the general public shall be provided in accordance with the requirements specified in Table 54.12-A and s. ILHR 52.04 (4) and (8).

TABLE 58.68

Type of Occupancy	Type of Fixture				
	Water Closets (WC)		Urinals	Lavatories (L)	Bathtubs or Showers
	Males(M)	Females(F)	Males		
Residents	One (WC) for each 8 (M), or fraction	One (WC) for each 8 (F), or fraction	Urinals may be substituted for up to 2/3 of the required no. of (WC)	One (L) for each 8 persons	1 for each persons or fraction thereof

History: Cr. Register, December, 1981, No. 312, eff. 1-1-82.

GUARD TOWERS

ILHR 58.69 Guard towers and observation stations. (1) CLASS OF CONSTRUCTION. (a) Except as provided in par. (b), guard towers shall be of type 1, 2 or 3 construction as specified in s. ILHR 51.03.

(b) Guard towers classified as Type 3 construction may have a non-combustible roof assembly with no fire-resistive rating. A Class A roof covering is acceptable.

(2) MEANS OF EGRESS. At least one exit stairway shall be provided from a guard tower or observation station and shall be a minimum of 28 inches in width. Spiral stairways are permitted to serve guard towers and observation stations not greater than 150 net square feet. Spiral stairways shall comply with s. ILHR 51.16 (7). **FP**

(3) INTERIOR FINISH. The interior finish of guard towers and observation stations shall be of Class A or B as defined in s. ILHR 51.01 (75a). **FP**

(4) HIGH HAZARD MATERIAL. Storage of high hazard material is prohibited in the guard tower, observation station, or immediate vicinity, except for weapons, ammunition, and control chemicals in quantities required for use by the staff occupying the tower or observation station. **FP**

(5) PROTECTION OF VERTICAL OPENINGS. Every stairway, elevator shaft, dumbwaiter shaft, or other similar vertical openings shall be enclosed with at least 2-hour fire-resistive construction as specified in s. ILHR 51.043, except guard towers and observation stations where there is no occupancy below the top floor level, stairs may be unenclosed. **FP**

(6) SANITARY FACILITIES. Toilet facilities are not required in guard towers or observation stations provided toilet facilities are available in adjacent buildings to accommodate the number of occupants in the guard towers or observation stations.

(7) DOOR LOCKS. Doors to guard towers may be locked in accordance with s. ILHR 58.59.

History: Cr. Register, December, 1981, No. 312, eff. 1-1-82; am. (2), Register, December, 1983, No. 336, eff. 1-1-84; am. (1), Register, August, 1985, No. 356, eff. 1-1-86.

Chapter ILHR 59

HAZARDOUS OCCUPANCIES

ILHR 59.001	Scope (p. 277)	ILHR 59.17	Enclosure of stairways and shafts (p. 283)
ILHR 59.01	Definitions (p. 277)	ILHR 59.18	Vehicular guardrails (p. 283)
ILHR 59.10	Scope (p. 277)	ILHR 59.19	Illumination levels (p. 283)
ILHR 59.11	Construction (p. 278)	ILHR 59.20	Sanitary facilities (p. 283)
ILHR 59.12	Height and area (p. 278)	ILHR 59.21	Isolation of hazards and separations (p. 284)
ILHR 59.13	Types of exits (p. 282)	ILHR 59.22	Occupancy separations - mixed occupancies (p. 284)
ILHR 59.14	Number and location of exits (p. 282)	ILHR 59.23	Fire protection (p. 287)
ILHR 59.15	Required exit width (p. 282-1)	ILHR 59.24	Fire alarms (p. 287)
ILHR 59.16	Capacity of structures (p. 282-2)		

Note: Chapter Ind 59 was renumbered chapter ILHR 59 effective January 1, 1984.

ILHR 59.001 Scope. This chapter applies to all hazardous occupancies as indicated in the scope of each subchapter.

History: Cr. Register, December, 1981, No. 312, eff. 1-1-82.

ILHR 59.01 Definitions. (1) "Combustible liquid" means a liquid as defined in s. Ind 8.01 (19).

(2) "Flammable liquid" means a liquid as defined in s. Ind 8.01 (37).

(3) "Motor vehicle" means any self-propelled device fueled by a flammable or combustible liquid used to transport people or goods.

(4) "Open parking structure" means a structure as defined in s. ILHR 62.10.

(5) "Private garage" means a structure or a part of a structure, either attached to a one- or 2-family dwelling or unattached but serving the dwelling, housing one or more motor vehicles owned by the occupant of the dwelling and used only for personal or family service, not serving as a place of employment.

(6) "Repair garage" means a structure or any part of a structure in which one or more motor vehicles are primarily repaired or serviced.

(7) "Storage garage" means any structure or part of a structure in which one or more motor vehicles are stored or parked and which is not a repair garage, private garage or open parking structure.

History: Cr. Register, December, 1981, No. 312, eff. 1-1-82.

ILHR 59.10 Scope. (1) Except as provided in sub. (2), the requirements of this subchapter apply to storage garages and repair garages.

Note: See ch. Ind 8 — Flammable and Combustible Liquids, for additional requirements pertaining to structures accommodating motor vehicles.

(2) This subchapter does not apply to the following occupancies:

(a) Storage garages serving community-based residential facilities within the scope of ch. ILHR 61;

Note: See s. ILHR 61.10 (2).

(b) Areas of factories and plants used for the manufacture or assembly of motor vehicles or their components;

(c) Drive-in or drive-through facilities not used for the storage of motor vehicles including, but not limited to those of banks, restaurants, hospitals, car washes, film processing centers or other similar occupancies; and

(d) Storage garages 500 sq. ft. or less in area serving a residential occupancy as specified in ch. ILHR 57.

Note: See s. ILHR 57.01 (4).

History: Cr. Register, December, 1981, No. 312, eff. 1-1-82.

ILHR 59.11 Construction. (1) FLOORS. (a) The floor areas accommodating motor vehicles shall be of earth, gravel or noncombustible, nonabsorbent materials.

(b) Service pits and other similar depressions in the floor of a storage or repair garage shall be ventilated in accordance with ch. ILHR 64.

(2) CLEARANCE REQUIREMENTS. Headroom clearances shall be maintained in accordance with s. ILHR 51.164.

(3) CANOPIES. Free standing canopies and their supports or other similar structures over fuel dispensing equipment, when located less than 10 feet from a property line, shall be constructed of noncombustible materials.

History: Cr. Register, December, 1981, No. 312, eff. 1-1-82; am. (1) (a), Register, October, 1982, No. 322, eff. 11-1-82.

ILHR 59.12 Height and area. (1) STORAGE GARAGES. Storage garages shall not exceed the number of stories and corresponding area limitations of Table 59.12-1 or 59.12-2.

(2) REPAIR GARAGES. Repair garages shall not exceed the number of stories and 75% of the corresponding area limitations of Table 59.12-1 or 59.12-2.

(3) ALLOWABLE INCREASE OF FLOOR AREAS. (a) *Automatic fire sprinkler system protection.* 1. Chapter ILHR 59 buildings not protected by automatic fire sprinkler systems may not exceed the height and area limitations specified in subs. (1) or (2) and Table 59.12-1.

2. a. Chapter ILHR 59 buildings protected by complete automatic fire sprinkler systems may not exceed the height and area limitations specified in subs. (1) or (2) and Table 59.12-2.

b. The area of one story aircraft hangars of type No. 1 to 6 construction may be unlimited provided the building is completely protected by an automatic fire sprinkler system and the building is provided with street access around its entire perimeter.

(b) *Fire divisions.* No storage or repair garage shall be limited in area where divided into sections which do not exceed the maximum areas tabulated in this section by fire division walls as specified in s. ILHR 51.02 (13). All openings in such walls shall be protected by swinging, sliding or overhead fire-resistive door assemblies as specified in s. ILHR 51.047. Doors protecting such openings may be held open if equipped with rate of rise heat or photoelectric activated automatic closing de-

vices. Doors used as required exits shall comply with the requirements of s. ILHR 51.15.

(4) **MINI-GARAGES.** Mini-garage buildings on the same property may be located less than 30 feet of each other with no restriction on the percentage of wall openings provided the combined gross area of the buildings, including the area between the buildings, is no more than the area permitted by this section.

History: Cr. Register, December, 1981, No. 312, eff. 1-1-82; correction in (3) (a) made under s. 13.93 (2m) (b) 7, Stats., cr. (4), Register, August, 1985, No. 356, eff. 1-1-86; emerg. r. table 59.12 and cr. tables 59.12-1 and 59.12-2, am. (1) and (2), r. and recr. (3) (a), eff. 9-6-86; r. table 59.12 and cr. table 59.12-1 and 59.12-2, am. (1) and (2), r. and recr. (3) (a), Register, November, 1986, No. 371, eff. 12-1-86.

TABLE 59.12-1 — ALLOWABLE HEIGHT (STORIES) AND AREA (SQUARE FEET) FOR BUILDINGS WITHOUT COMPLETE AUTOMATIC FIRE
 SPRINKLER SYSTEM PROTECTION (MAXIMUM GROSS FLOOR AREA PER FLOOR)
 NOTE #1: DO NOT USE FOR BUILDINGS EXCEEDING 60 FEET IN HEIGHT
 NOTE #2: FOR STORAGE GARAGES ONLY. USE 75% OF VALUES FOR REPAIR GARAGES

CLASS OF CONSTRUCTION	BUILDING FRONTAGE STREET* EXPOSURE	NUMBER OF STORIES								
		1	2	3	4	5	6	7	8	Over 8
1. Fire-Resistive Type A	1	25,000	22,000	19,000	16,000	13,000	11,000	9,000	8,000	6,000
	2	30,500	27,000	24,000	20,500	17,500	15,000	13,000	12,000	10,000
	3	36,000	33,000	29,000	25,000	22,000	19,000	17,000	16,000	14,000
	4	41,500	39,000	34,000	29,500	26,500	23,000	21,000	20,000	18,000
2. Fire-Resistive Type B	1	23,000	20,000	17,000	14,000	11,000	9,000	7,000	6,000	N.P.
	2	28,500	25,000	22,000	18,500	15,500	13,000	11,000	10,000	
	3	34,000	31,000	27,000	23,000	20,000	17,000	15,000	14,000	
	4	39,500	37,000	32,000	27,500	24,500	21,000	19,000	18,000	
3. Metal Frame Protected	1	21,000	18,000	15,000	12,000	N.P.	N.P.	N.P.	N.P.	N.P.
	2	26,500	23,000	19,500	16,000					
	3	32,000	28,000	24,000	20,000					
	4	37,500	33,000	28,500	24,000					
4. Heavy Timber	1	17,000	14,000	11,000	9,000	N.P.	N.P.	N.P.	N.P.	N.P.
	2	22,000	19,000	16,000	13,500					
	3	27,000	24,000	21,000	18,000					
	4	32,000	29,000	26,000	22,500					
5A. Exterior Masonry Protected	1	15,500	13,500	9,500	8,000	N.P.	N.P.	N.P.	N.P.	N.P.
	2	20,000	17,000	14,000	12,500					
	3	24,500	21,500	18,500	15,500					
	4	29,000	26,000	23,000	19,500					
5B. Exterior Masonry Unprotected	1	14,000	11,500	9,000	7,000	N.P.	N.P.	N.P.	N.P.	N.P.
	2	18,000	15,000	12,500	10,000					
	3	22,000	19,000	16,000	13,000					
	4	26,000	23,000	19,500	16,000					
6. Metal Frame Unprotected	1	14,000	11,500	9,000	N.P.	N.P.	N.P.	N.P.	N.P.	N.P.
	2	18,000	15,000	12,500						
	3	22,000	19,000	16,000						
	4	26,000	23,000	19,500						
7. Wood Frame Protected	1	12,500	N.P.	N.P.	N.P.	N.P.	N.P.	N.P.	N.P.	N.P.
	2	16,000								
	3	19,000								
	4	22,000								
8. Wood Frame Unprotected	1	10,000	N.P.	N.P.	N.P.	N.P.	N.P.	N.P.	N.P.	N.P.
	2	12,000								
	3	14,000								
	4	16,000								

N.P. MEANS NOT PERMITTED

* 4-HOUR FIRE DIVISION WALL SHALL BE CONSIDERED AS A STREET FOR THE PURPOSE OF COMPUTING THE AREA LIMITATIONS
 OR THIS TABLE

TABLE 59.12-2 — ALLOWABLE HEIGHT (STORIES) AND AREA (SQUARE FEET) FOR BUILDINGS COMPLETELY PROTECTED BY AUTOMATIC FIRE SPRINKLER SYSTEM (MAXIMUM GROSS FLOOR AREA PER FLOOR)

NOTE #1: USE FOR ALL BUILDINGS

NOTE #2: FOR STORAGE GARAGES ONLY. USE 75% OF VALUES FOR REPAIR GARAGES

CLASS OF CONSTRUCTION	BUILDING FRONTAGE STREET* EXPOSURE	NUMBER OF STORIES									
		1	2	3	4	5	6	7	8	9	Over 9
1. Fire-resistive Type A One street required for unlimited area. See s. ILHR 51.01 (124)	1	NO LIMIT									
	2	NO LIMIT									
	3	NO LIMIT									
	4	NO LIMIT									
2. Fire-resistive type B One street required for unlimited area. See s. ILHR 51.01 (124)	1	NO LIMIT	69,000	60,000	51,000	42,000	33,000	27,000	21,000	18,000	N.P.
	2	NO LIMIT	85,500	75,000	66,000	55,500	46,500	39,000	33,000	30,000	N.P.
	3	NO LIMIT	102,000	93,000	81,000	69,000	60,000	51,000	45,000	42,000	N.P.
	4	NO LIMIT	118,500	111,000	96,000	82,500	73,500	63,000	57,000	54,000	N.P.
3. Metal frame protected	1	84,000	63,000	54,000	45,000	36,000	N.P.	N.P.	N.P.	N.P.	N.P.
	2	106,000	79,500	69,000	58,500	48,000	N.P.	N.P.	N.P.	N.P.	N.P.
	3	128,000	96,000	84,000	72,000	60,000	N.P.	N.P.	N.P.	N.P.	N.P.
	4	150,000	112,500	99,000	85,500	72,000	N.P.	N.P.	N.P.	N.P.	N.P.
4. Heavy Timber	1	68,000	51,000	42,000	33,000	27,000	N.P.	N.P.	N.P.	N.P.	N.P.
	2	88,000	66,000	57,000	48,000	40,500	N.P.	N.P.	N.P.	N.P.	N.P.
	3	108,000	81,000	72,000	63,000	54,000	N.P.	N.P.	N.P.	N.P.	N.P.
	4	128,000	96,000	87,000	78,000	67,500	N.P.	N.P.	N.P.	N.P.	N.P.
5A. Exterior Masonry Protected	1	62,000	46,500	40,500	28,500	24,000	N.P.	N.P.	N.P.	N.P.	N.P.
	2	80,000	60,000	51,000	42,000	37,500	N.P.	N.P.	N.P.	N.P.	N.P.
	3	98,000	73,500	64,500	55,500	46,500	N.P.	N.P.	N.P.	N.P.	N.P.
	4	116,000	87,000	78,000	69,000	58,500	N.P.	N.P.	N.P.	N.P.	N.P.
5B. Exterior Masonry Unprotected	1	56,000	42,000	34,500	27,000	N.P.	N.P.	N.P.	N.P.	N.P.	N.P.
	2	72,000	54,000	45,000	37,500	N.P.	N.P.	N.P.	N.P.	N.P.	N.P.
	3	88,000	66,000	57,000	48,000	N.P.	N.P.	N.P.	N.P.	N.P.	N.P.
	4	104,000	78,000	69,000	58,500	N.P.	N.P.	N.P.	N.P.	N.P.	N.P.
6. Metal Frame Unprotected	1	56,000	42,000	34,500	27,000	N.P.	N.P.	N.P.	N.P.	N.P.	N.P.
	2	72,000	54,000	45,000	37,500	N.P.	N.P.	N.P.	N.P.	N.P.	N.P.
	3	88,000	66,000	57,000	48,000	N.P.	N.P.	N.P.	N.P.	N.P.	N.P.
	4	104,000	78,000	69,000	58,500	N.P.	N.P.	N.P.	N.P.	N.P.	N.P.
7. Wood Frame Protected	1	50,000	37,500	N.P.	N.P.	N.P.	N.P.	N.P.	N.P.	N.P.	N.P.
	2	64,000	48,000	N.P.	N.P.	N.P.	N.P.	N.P.	N.P.	N.P.	N.P.
	3	76,000	57,000	N.P.	N.P.	N.P.	N.P.	N.P.	N.P.	N.P.	N.P.
	4	88,000	66,000	N.P.	N.P.	N.P.	N.P.	N.P.	N.P.	N.P.	N.P.
8. Wood Frame Unprotected	1	40,000	30,000	N.P.	N.P.	N.P.	N.P.	N.P.	N.P.	N.P.	N.P.
	2	48,000	36,000	N.P.	N.P.	N.P.	N.P.	N.P.	N.P.	N.P.	N.P.
	3	56,000	42,000	N.P.	N.P.	N.P.	N.P.	N.P.	N.P.	N.P.	N.P.
	4	64,000	48,000	N.P.	N.P.	N.P.	N.P.	N.P.	N.P.	N.P.	N.P.

N.P. MEANS NOT PERMITTED

*4-HOUR FIRE DIVISION WALL SHALL BE CONSIDERED AS A STREET FOR THE PURPOSE OF COMPUTING THE AREA LIMITATIONS FOR THIS TABLE.

Hazardous occupancies

INDUSTRY, LABOR AND HUMAN RELATIONS

ILHR 59

FP ILHR 59.13 Types of exits. (1) **GENERAL.** (a) Only the following types of exits shall be used to comply with the provisions of s. ILHR 59.14:

1. Standard exit as specified in s. ILHR 51.15, except as provided in sub. (2);
2. Stairways as specified in s. ILHR 51.16, except as provided in sub. (2);
3. Smokeproof stair tower as specified in s. ILHR 51.17;
4. Interior enclosed stairway as specified in s. ILHR 51.18;
5. Horizontal exit as specified in s. ILHR 51.19;
6. Fire escapes as specified in s. ILHR 51.20; and
7. Nonparking access ramps with a maximum slope of 1:8.

(b) At least half of the exits required under s. ILHR 59.14 shall be standard exits, stairways, smokeproof stair towers or interior enclosed stairways to grade.

(2) **EXCEPTIONS.** (a) A spiral stairway shall not serve as a required exit, but may be used as an employe convenience stairway if located in nonpublic areas.

(b) The width of required exit stairways serving unoccupied areas, such as storage areas, equipment mezzanines and similar areas not exceeding 750 sq. ft. may be reduced to 3 feet 0 inches.

(c) Doors in standard exits serving rooms, spaces or areas with an occupancy load of 25 persons or less are not required to swing in the direction of egress.

(d) A door not complying with s. ILHR 51.15 (2), may be used as a standard exit serving storage garages or storage areas not exceeding 3,000 square feet in area.

Note: Where accessibility and interior circulation for persons with functional limitations must be provided, the requirements of s. ILHR 52.04 (9) govern.

History: Cr. Register, December, 1981, No. 312, eff. 1-1-82; am. (2) (d), Register, August, 1985, No. 356, eff. 1-1-86.

FP ILHR 59.14 Number and location of exits. (1) **GENERAL.** (a) Except as provided in par. (b), every floor level and every room, space or area of a storage garage and a repair garage shall be provided with at least 2 exits.

(b) One exit is permitted from the following:

1. Any room, space or area used for storage garage purposes with an occupancy load of 10 persons or less and which does not exceed 3,000 sq. ft. in net floor area;
2. Any room, space or area used for repair garage purposes and does not exceed 750 sq. ft. in net floor area;
3. Any room, space or area used as other than a storage or repair garage with an capacity of 25 persons or less; and
4. A mezzanine floor level, provided the mezzanine is:
 - a. Three thousand square feet or less in net floor area;

- b. Used only for storage purposes;
- c. Open on at least one side to the floor below; and
- d. Not more than 12 feet above the floor below.

(2) **EXIT DISTANCE.** Exits shall be provided and distributed as follows:

(a) *Storage garages.* 1. No area of a storage garage shall be more than 100 feet from an exit, unless the entire storage garage is protected by an automatic sprinkler system.

2. No area of a storage garage entirely protected by an automatic fire sprinkler system shall be more than 200 feet from an exit.

(b) *Repair garages.* 1. No area of a repair garage shall be more than 75 feet from an exit, unless the entire repair garage is protected by an automatic fire sprinkler system.

2. No area of a repair garage entirely protected by an automatic fire sprinkler system shall be more than 150 feet from an exit.

(c) * *Measurement of exit distance.* The exit distances required by this section shall be measured along public passageways and aisles to:

- 1. Standard exits leading to grade as specified in s. ILHR 51.15;
- 2. Doors opening into smokeproof stair towers as specified in s. ILHR 51.17, interior enclosed stairways as specified in s. ILHR 51.18, or fire escapes as specified in s. ILHR 51.20; or
- 3. Horizontal exits as specified in s. ILHR 51.19.

(3) **LOCATION OF EXITS.** Except as provided in sub. (1) (b), exits in all storage garages and repair garages shall be located and distributed so that in the event an exit is blocked, another exit is available from every area of the storage garage or repair garage.

(4) **EXIT LIGHTS.** All required exits shall be identified by an approved exit light. Directional exit lights shall be provided to direct occupants to the exits. Exit lights and directional exit lights shall be as specified in s. ILHR 51.15 (5).

(5) **EXIT MAINTENANCE.** Exits shall be maintained in accordance with s. ILHR 52.21.

History: Cr. Register, December, 1981, No. 312, eff. 1-1-82; cr. (4), Register, December, 1983, No. 336, eff. 1-1-84; emerg. am. (2) (a) 2. and (b), eff. 9-6-86; am. (2) (a) 2. and (b), Register, November, 1986, No. 371, eff. 12-1-86.

ILHR 59.15 Required exit width. (1) **GENERAL.** Every floor level of a storage garage and repair garage shall be provided with at least the required aggregate width of exits as specified in ss. ILHR 51.15 (6) and 51.16 (3).

(2) **HORIZONTAL EXITS.** Horizontal exits may provide up to one-half of the required aggregate width of exits for a floor level.

History: Cr. Register, December, 1981, No. 312, eff. 1-1-82.

*See Appendix A for further explanatory material.

282-2

WISCONSIN ADMINISTRATIVE CODE

ILHR 59

Hazardous occupancies

ILHR 59.16 Capacity of structures. In calculating the required aggregate width of exits under s. ILHR 59.15 and the required number of sani-

tary facilities under s. ILHR 59.20, the capacities of structures and floor levels shall be computed on the following basis:

- (1) Storage garages and repair garages - 300 sq. ft. per person; and
- (2) Other areas as dictated by the appropriate sections of chs. ILHR 54 to 62.

Note: See ss. ILHR 54.05, 55.06, 56.07 for additional requirements.

History: Cr. Register, December, 1981, No. 312, eff. 1-1-82.

ILHR 59.17 Enclosure of stairways and shafts. (1) **GENERAL.** (a) Except as provided in par. (b), all stairways and shafts within a storage garage and a repair garage shall be fully enclosed with smoke partitions. Smoke partitions shall be constructed of solid and rigid materials. Openings in such enclosures shall be protected with doors equipped with automatic closing devices. **FP**

(b) Stairways to open storage mezzaniness 3,000 square feet or less in area are not required to be enclosed.

(2) **THREE OR MORE FLOOR LEVELS.** Stairways and shafts serving 3 or more floor levels shall be enclosed pursuant to s. ILHR 51.18 with fire-resistive construction as specified in Table 51.03-A.

History: Cr. Register, December, 1981, No. 312, eff. 1-1-82; reprinted to correct error in (2), Register, February, 1982, No. 314; am. (2), Register, October, 1982, No. 322, eff. 11-1-82.

ILHR 59.18 Vehicular guardrails. Vehicular guardrails shall be provided at all floor openings and at all differences in floor level elevations as follows:

(1) **DRIVE LANES.** Vehicular guardrails shall be installed at the end of drive lanes and shall be designed for a minimum horizontal live load of 1000 pounds per linear foot acting at 18 inches above the floor level; and

(2) **PARKING STALLS.** Vehicular guardrails shall be installed at the end of parking stalls and shall be designed for a minimum horizontal live load of 500 pounds per linear foot acting at 18 inches above the floor level.

History: Cr. Register, December, 1981, No. 312, eff. 1-1-82.

ILHR 59.19 Illumination levels. (1) **EXITS.** All stairways and exits and the passageways leading to them shall be illuminated to facilitate egress. The intensity of illumination shall be not less than 10 footcandles at the floor or step level. **FP**

(2) **DRIVING AREAS.** The minimum illumination level for driving areas at a horizontal plane 30 inches above the floor shall be an intensity of at least 2 footcandles.

History: Cr. Register, December, 1981, No. 312, eff. 1-1-82.

ILHR 59.20 Sanitary facilities. (1) **GENERAL.** Sanitary facilities shall be provided as specified in ss. ILHR 54.12, 55.32 or 56.16, as appropriate for the use of the building.

(2) **UNATTENDED STORAGE GARAGES.** Sanitary facilities are not required to be provided in unattended storage garages.

History: Cr. Register, December, 1981, No. 312, eff. 1-1-82.

FP

ILHR 59.21 Isolation of hazards and separations. All fuel-fired heating equipment, except direct vent sealed combustion chamber appliances, within a storage garage and a repair garage, including, but not limited to boilers, furnaces and water heaters, shall be isolated from the remainder of the storage garage or repair garage by at least 2-hour fire-resistive construction as specified in s. ILHR 51.04 or shall be installed as specified in sub. (3).

(1) **PROTECTION OF OPENINGS.** All openings in required enclosures shall be protected with self-closing fire-resistive door assemblies as specified in s. ILHR 51.047. The installation or use of hold-open devices for these doors shall be prohibited.

(2) **PROHIBITED OPENINGS.** (a) Except as provided in par. (b), openings shall be prohibited in any building component separating garage areas and fuel-fired heating equipment where the fuel-fired heating equipment is located below the elevation of the garage floor.

(b) Supply and return air grilles or registers in garage areas are permitted if the bottom of the grille or register opening is at least 18 inches above the garage floor.

(3) **SUSPENDING EQUIPMENT.** (a) Except as provided in par. (b), boilers up to 200,000 Btu input, water heaters up to 200,000 Btu input, gas and liquid fuel-fired space heaters, suspended furnaces, vented and unvented unit heaters may be used without an enclosure where approved by the department. Where suspended furnaces, vented and unvented unit heaters, boilers and water heaters are used without an enclosure, all units shall be located at least 8 feet above the floor or, in aircraft hangars, 10 feet above the upper surface of the wing or engine enclosure of the aircraft. The blow-off pipe for suspended boilers and water heaters shall be extended down to within 6 inches of the floor.

(b) The rated enclosure for heating equipment in storage or repair garages may be omitted if the burner of the equipment is located at least 8 feet off the floor and the equipment is protected from physical damage.

Note: See s. ILHR 64.21 for additional requirements.

History: Cr. Register, December, 1981, No. 312, eff. 1-1-82; am. (intro.) and (2) (a), Register, December, 1983, No. 336, eff. 1-1-84; am. (intro.) and cr. (3), Register, August, 1985, No. 356, eff. 1-1-86.

ILHR 59.22 Occupancy separations—mixed occupancies. (1) **GENERAL.** (a) Where a storage garage or a repair garage is located in a building used for other purposes, not within the scope of this chapter, the storage garage or repair garage shall be separated from any other occupancy by construction having at least the fire-resistive ratings as specified in Table 59.22.

(b) Where a storage garage or a repair garage is located below an exit court of any occupancy, the storage garage or repair garage shall be separated from the exit court by construction having at least the fire-resistive ratings as specified in Table 59.22.

(2) **PARAPETS.** (a) All walls with a 3-hour fire-resistive rating serving as a required occupancy separation shall be provided with a 3-hour fire-resistive rated parapet at least one foot in height.

Register, August, 1985, No. 356

(b) All walls with a 4-hour fire-resistive rating serving as a required occupancy separation shall be provided with a 4-hour fire-resistive rated parapet at least 3 feet in height.

(3) OPENINGS. (a) All openings in walls serving as a required occupancy separation shall be protected by means of self-closing fire-resistive door assemblies as specified in s. ILHR 51.047.

(b) All floors and ceilings serving as a required occupancy separation shall be unpierced, except for plumbing or electrical components.

Note: See s. ILHR 51.049 for plastic plumbing and electrical components penetrating fire-rated construction.

TABLE 59.22
OCCUPANCY SEPARATIONS FIRE-RESISTIVE RATINGS IN HOURS

OCCUPANCY TYPES	CH ^{1,3} 54	CH 55	CH 56	CH 57	CH 58	CH ² 59	CH ⁴ 60	CH 61	CH ² 62	BELOW EXIT COURTS
Storage Garage greater than 500 sq. ft.	2	3	2	2	3	0	2	See s. ILHR 61.10 (2)	0	3
Storage Garage equal to or less than 500 sq. ft.	1	3	2	See s. ILHR 57.01 (4)	3	0	1	See s. ILHR 61.10 (2)	0	3
Repair Garage greater than 500 sq. ft.	3	4	3	3	4	0	3	3	0	4
Repair Garage equal to or less than 500 sq. ft.	2	4	3	2	4	0	2	2	0	4

¹ Occupancy separations are not required within a fire station or other similar occupancy to isolate vehicles from other areas of the building that are directly and permanently related to the functions of the building.

² An occupancy separation is not required to separate a storage garage, repair garage or open parking structure from each other, however, the most stringent occupancy requirements shall apply. Where these areas are to be classified as separate occupancies, a separation of at least one-hour fire-resistive construction shall be provided.

³ Occupancy separations are not required within an office, factory, or warehouse occupancies only, with a storage garage accommodating one or 2 vehicles which are directly related to the functions of that occupancy. Where a storage garage accommodating one or 2 vehicles within an office, factory or warehouse is part of a multi-occupancy/multi-tenant building (i.e., strip shopping center) the occupancy separation must at least be provided at the adjoining tenant's wall.

⁴ Storage garages in buildings used exclusively for a day care center serving 4 to 8 children or a day care center serving 4 to 8 children in conjunction with a one- or 2-family dwelling shall be separated from the day care center as specified in s. ILHR 21.08 (2).

History: Cr. Register, December, 1981, No. 812, eff. 1-1-82; am. table, Register, October, 1982, No. 322, eff. 11-1-82; am. table, Register, December, 1983, No. 336, eff. 1-1-84.

ILHR 59.23 Fire protection. (1) STANDPIPES. (a) Except as provided in FP par. (e), fire department standpipes shall be provided as follows:

1. In all storage garages and repair garages 3 or more stories in height; and

2. In all storage garage and repair garage floor levels more than 500 sq. ft. in area, located below grade and not accessible to fire fighting vehicles.

(b) Required fire department standpipes with a fire department siamese connection greater than 50 feet to a street shall be interconnected to a standpipe system with such a connection 50 feet or less to a street.

(c) Required fire department standpipes shall be provided in each stair enclosure serving a storage or repair garage and shall be provided with approved 2½ in. valve hose connections at each floor level with one connection in the stair tower and one immediately outside.

(d) Fire department standpipes shall conform to the requirements specified in s. ILHR 51.21 (3) (e) to (i).

(e) 1. The department will recognize alternative systems and designs in lieu of required fire department standpipes, if an equivalent degree of safety is provided in storage or repair garages 60 feet or less in height.

2. The department will accept storage garages or repair garages without fire department standpipes, if clearances are provided to allow fire fighting vehicles access throughout the storage or repair garages.

3. Fire department standpipes as specified in this subsection need not be provided in buildings 60 feet or less in height completely protected by an automatic fire sprinkler system.

4. Fire department standpipes shall be provided in buildings more than 60 feet in height in accordance with s. ILHR 51.21 (3).

(2) * **FIRE EXTINGUISHERS.** Portable fire extinguishers shall be provided and maintained as specified in s. ILHR 51.22.

Note: See ch. ILHR 52, subch. II for requirements pertaining to automatic fire sprinkler systems.

History: Cr. Register, December, 1981, No. 312, eff. 1-1-82; r. (2), renun. (3) to be (2), Register, June, 1983, No. 330, eff. 7-1-83; emerg. cr. (1) (e) 3. and 4., eff. 9-6-86; cr. (1) (e) 3. and 4., Register, November, 1986, No. 371, eff. 12-1-86.

ILHR 59.24 Fire alarms. A fire alarm system complying with s. ILHR 51.24 shall be provided in every storage garage and repair garage where more than 10 persons are employed above the second story except storage garages and repair garages which are provided with a complete automatic sprinkler system.

History: Cr. Register, December, 1981, No. 312, eff. 1-1-82.

*See Appendix A for further explanatory material.

Chapter ILHR 60

CHILD DAY CARE FACILITIES

ILHR 60.001	Scope (p. 289)	ILHR 60.19	Operating features (p. 292)
ILHR 60.01	Definitions (p. 289)	ILHR 60.30	Class of construction (p. 293)
ILHR 60.10	Occupancy separations (p. 290)	ILHR 60.31	Exiting (p. 293)
ILHR 60.105	Height of first floor above grade (p. 290)	ILHR 60.32	Required exit width (p. 294)
ILHR 60.11	Capacity of buildings (p. 290)	ILHR 60.33	Passageways (p. 294)
ILHR 60.12	Doors (p. 290)	ILHR 60.34	Stair and shaft enclosure (p. 294)
ILHR 60.13	Windows and outside openings (p. 291)	ILHR 60.35	Fire extinguishers (p. 294)
ILHR 60.15	Sanitary facilities (p. 291)	ILHR 60.36	Fire alarm and detection systems (p. 295)
ILHR 60.16	Electrical work (p. 291)	ILHR 60.37	Hazardous areas (p. 295)
ILHR 60.17	Illumination (p. 292)	ILHR 60.38	Exit and emergency lighting (p. 295)
ILHR 60.18	Heating and ventilating (p. 292)		

Note: Chapter Ind 60 was renumbered chapter ILHR 60, effective in January 1, 1984.

Note: See ch. HSS 45 relating to day care licensing.

ILHR 60.001 Scope. (1) (a) The requirements of this chapter shall apply to all buildings or parts of buildings which accommodate public or private day care centers for 9 or more children.

(b) The requirements of this chapter shall not apply to public school programs defined in s. 115.01 (1), Stats., or private school programs defined in s. 121.51 (3), Stats., or to short-time programs such as Boy Scouts, Girl Scouts, Sunday school and similar type programs.

Note: Refer to ch. HSS 45, rules of the department of health and social services for requirements pertaining to day care centers serving 4 to 8 children.

(2) Chapters ILHR 50 to 53 are applicable for general and structural design requirements. Chapters ILHR 63 and 64 are applicable to newly constructed day care centers and to alterations to mechanical systems.

(3) School age day care programs for children 5 years of age and older shall comply with the requirements of one of the following chapters:

(a) Ch. ILHR 56 - Schools and Other Places of Instruction; or

(b) Ch. ILHR 60 - Child Day Care Facilities.

History: Cr. Register, October, 1974, No. 226, eff. 11-1-74; am. (4), Register, December, 1983, No. 336, eff. 1-1-84; cr. (5), Register, August, 1985, No. 356, eff. 9-1-85; emerg. r. and recr. eff. 9-1-89; r. and recr. Register, February, 1990, No. 410, eff. 3-1-90.

ILHR 60.01 Definitions. (1) **DAY CARE CENTER.** Any place which receives at any one time for compensation 4 or more children under the age of 7 years, for care and supervision, for less than 24 hours a day for more than 10 days a month, without the attendance of a parent, relative or legal guardian.

History: Cr. Register, October, 1974, No. 226, eff. 11-1-74.

ILHR 60.10 Occupancy separations. (1) Except as provided in sub. (2), where a day care center is located in a building used also for assembly hall or hazardous occupancy purposes, the day care center shall be separated

Register, February, 1990, No. 410

rated from the assembly hall or hazardous occupancy with occupancy separations as specified in ss. ILHR 55.05 and 59.22, respectively.

(2) An occupancy separation as specified under s. ILHR 55.05 is not required to separate a day care center from a church assembly hall occupancy if the day care center complies with the more stringent requirements of ch. ILHR 55.

History: Cr. Register, October, 1974, No. 226, eff. 11-1-74; r. and recr., Register, December, 1981, No. 312, eff. 1-1-82.

ILHR 60.105 Height of first floor above grade. The elevation of the first floor and the sills of all required exit discharges from the first floor shall be at or not more than 6 feet above an exit discharge grade for existing buildings to be licensed as child day care centers.

History: Cr. Register, December, 1983, No. 336, eff. 1-1-84.

ILHR 60.11 Capacity of buildings. The occupant load shall be the maximum number of children intended to occupy that floor, but not more than one child per 35 square feet of net floor area. Licensing limitations of the department of health and social services may supersede this requirement.

Note: The minimum staff-to-child ratio shall meet the requirements of ch. HSS 55 which is as follows:

Age	Minimum number of staff to children
0-1 years	1 to 3 children
1-2 years	1 to 4 children
2-2½ years	1 to 6 children
2½-3 years	1 to 8 children
3-4 years	1 to 10 children
4-5 years	1 to 12 children
5 years or over	1 to 16 children

History: Cr. Register, October, 1974, No. 226, eff. 11-1-74.

FP ILHR 60.12 Doors. (1) All exit doors, and all doors along the path of travel to an exit, shall meet the requirements of s. ILHR 51.15 with the following exceptions:

(a) The width of all required exit doors may be reduced to 2 feet 8 inches in existing buildings not accommodating more than 8 children;

(b) All such doors used by not more than 25 persons need not swing outward;

(c) All such doors in centers serving 20 or less children need not be provided with illuminated exit signs; and

(d) Sliding glazed patio-type doors may serve as the second exit. A means to prevent accumulation of snow and ice in the door track or freezing of the door shall be provided.

(2) Every closet door latch shall be such that children can open the door from inside the closet.

(3) Every toilet room door lock shall be designed to permit opening of the locked door from the outside in an emergency, and the opening device shall be readily accessible to the staff.

History: Cr. Register, October, 1974, No. 226, eff. 11-1-74; cr. (1)(d), Register, December, 1977, No. 264, eff. 1-1-78; r. (1)(a), renum. (1)(b) to (d) to be (1)(a) to (c), Register, January, Register, February, 1990, No. 410

1980, No. 289, eff. 2-1-80; am. (1) (c), Register, May, 1980, No. 293, eff. 6-1-80; cr. (1) (d), Register, December, 1981, No. 312, eff. 1-1-82.

ILHR 60.13 Windows and outside openings. (1) All areas used for sleeping purposes shall be provided with vision panels or windows facing directly upon a street, alley, or open court. The vision panels or windows shall be glazed with glass or other approved material.

(2) The windows or vision panels shall have a total glazed area of at least 8% of the floor area of the room served. The openable area of the windows shall be equal to at least 4% of the floor area of the room served.

(3) See s. ILHR 60.18 (2) for exception to the requirement for openable windows.

History: Cr. Register, October, 1974, No. 226, eff. 11-1-74; am. (2) and (3), Register, January, 1980, No. 289, eff. 2-1-80; r. and recr. (2), Register, December, 1981, No. 312, eff. 1-1-82; am. (2), Register, October, 1982, No. 322, eff. 11-1-82; am. (1), Register, December, 1983, No. 336, eff. 1-1-84.

ILHR 60.15 Sanitary facilities. (1) **FIXTURES REQUIRED.** Toilet facilities shall be provided in all day care centers.

(a) One water closet shall be provided for the first 10 children. One water closet shall be provided for each additional 15 children, or fraction.

(b) Children under the age of 24 months need not be included when determining the required fixtures; however, in all cases, at least one water closet and one lavatory shall be provided in all day care centers.

(c) Water closets and urinals for the staff, in accordance with s. ILHR 54.12, shall be provided in addition to those required for the children, in day care centers with 10 or more staff members at any one time.

(d) Urinals may be substituted for up to $\frac{1}{3}$ of the total required water closets.

(e) Lavatories shall be provided in the ratio of one lavatory for every 2 required water closets and urinals, or fraction.

(2) **PRIVACY.** (a) Doors to the toilet rooms and water closet compartments may be omitted for toilet rooms used by children, provided that other toilet facilities equipped with toilet room doors and water closet compartments, are available for the staff and children 10 years of age and older.

(b) Sex designated toilet rooms shall be provided, available for staff use, in centers having 10 or more staff members at any one time.

Note: #1: The term "staff member," as used in this section, is intended to include all employees, whether on pay status or on a volunteer status.

Note: #2: The intent of sub. (2) is to allow toilet rooms used in common by both sexes in day care centers with less than 10 adults, and to omit the privacy requirements of toilet room doors and water closet compartments only for children who have not reached the age of sex awareness.

History: Cr. Register, October, 1974, No. 226, eff. 11-1-74; r. and recr. Register, December, 1976, No. 252, eff. 1-1-77; r. and recr., Register, December, 1977, No. 264, eff. 1-1-78; am. (1) (b) and (e), Register, August, 1985, No. 356, eff. 9-1-85.

ILHR 60.16 Electrical work. (1) The electrical systems in existing buildings proposed to be used as day care centers shall conform to the Wisconsin state electrical code, volume 2, ch. ILHR 16. **FP**

(2) Special protective receptacle covers shall be installed in all areas occupied by children.

History: Cr. Register, October, 1974, No. 226, eff. 11-1-74.

ILHR 60.17 Illumination. The illumination for occupied areas, other than sleeping areas, shall have a minimum intensity of 20 foot-candles at a horizontal plane 24 inches above the floor. All other spaces shall meet the requirements of s. Ind 19.04.

History: Cr. Register, October, 1974, No. 226, eff. 11-1-74.

ILHR 60.18 Heating and ventilating. (1) The heating system shall be capable of maintaining an inside temperature of not less than 67° F.

(2) Fresh air at the rate of 5 cubic feet per minute per occupant shall be provided for centers that do not comply with the openable window requirements of s. ILHR 60.13 (2).

History: Cr. Register, October, 1974, No. 226, eff. 11-1-74; am. (2), Register, January, 1980, No. 289, eff. 2-1-80.

FP ILHR 60.19 Operating features. (1) Fire prevention inspections shall be conducted monthly. A copy of the latest completed inspection form shall be posted in a conspicuous place in the day care facility.

(2) A fire evacuation plan shall be practiced not less than once per month. Fire alarm and/or smoke detection systems shall be tested at weekly intervals. It is recommended that fire safety be a part of the educational program of the center.

(3) Furnishings, decorations, or other objects shall not be so placed as to obstruct exits, access thereto, egress therefrom, or visibility thereof.

(4)* Flammable and combustible liquids shall be stored in areas accessible only to designated individuals and as recommended in NFPA standard No. 30, Flammable and Combustible Liquids Code.

Note: NFPA standard No. 30 is not a mandatory standard.

(5) Railings guarding differences of elevation (i.e., open sides of stairways, elevated platforms, walks, balconies, mezzanines) shall be designed to prevent the passage of an object with a diameter larger than 9 inches.

History: Cr. Register, October, 1974, No. 226, eff. 11-1-74; cr. (5), Register, January, 1980, No. 289, eff. 2-1-80.

ILHR 60.20 Class of construction. History: Cr. Register, October, 1974, No. 226, eff. 11-1-74; emerg. r. eff. 9-1-89; r. Register, February, 1990, No. 410, eff. 3-1-90.

ILHR 60.21 Exiting. History: Cr. Register, October, 1974, No. 226, eff. 11-1-74; am. (1), Register, December, 1977, No. 264, eff. 1-1-78; am. (1), Register, December, 1983, No. 336, eff. 1-1-84; emerg. r. eff. 9-1-89; r. Register, February, 1990, No. 410, eff. 3-1-90.

ILHR 60.22 Passageways. History: Cr. Register, October, 1974, No. 226, eff. 11-1-74; emerg. r. eff. 9-1-89; r. Register, February, 1990, No. 410, eff. 3-1-90.

ILHR 60.23 Stair and shaft enclosure. History: Cr. Register, October, 1974, No. 226, eff. 11-1-74; am. (3), Register, October, 1982, No. 322, eff. 11-1-82; am. (3), Register, December, 1983, No. 336, eff. 1-1-84; r. and recr. (3), Register, August, 1985, No. 356, eff. 9-1-85; emerg. r. eff. 9-1-89; r. Register, February, 1990, No. 410, eff. 3-1-90.

ILHR 60.24* Fire extinguishers. History: Cr. Register, October, 1974, No. 226, eff. 11-1-74; emerg. r. eff. 9-1-89; r. Register, February, 1990, No. 410, eff. 3-1-90.

*See Appendix A for further explanatory material.

Register, February, 1990, No. 410

ILHR 60.25 Hazardous areas. History: Cr. Register, October, 1974, No. 226, eff. 11-1-74; am. (1) (a), Register, December, 1975, No. 240, eff. 1-1-76; am. (1) (intro.), Register, August, 1985, No. 356, eff. 1-1-86; emerg. r. eff. 9-1-89; r. Register, February, 1990, No. 410, eff. 3-1-90.

ILHR 60.30 Class of construction. (1) Class of construction for day care centers shall comply with Table 60.30. Day care centers located in buildings of more than 4 stories shall be provided with one independent stairway serving the day care center only and restricted to the height indicated in Table 60.30.

TABLE 60.30

Type of Construction	Maximum Allowable Height (feet)	Maximum Allowable Number of Stories			
		1	2	3	4
Fire-resistive Type A No. 1 and Type B No. 2	85	X	X	X	X
Metal Frame Protected No. 3 and Heavy Timber No. 4	75	X	X	X	
Exterior Masonry No. 5	50	X	(c)	(a) & (b) or (a) & (d)	
Metal Frame Unprotected No. 6	50	X	(c)	(a)	
Wood Frame Protected No. 7	40	X	X		
Wood Frame Unprotected No. 8	35	X	(c)		

X = permitted.

(a) All floors and supporting members shall have a one-hour fire-resistive rating.

(b) The entire building shall be equipped with an automatic sprinkler system in accordance with s. ILHR 51.23.

(c) All ceilings shall be covered with ½-inch gypsum wallboard or equivalent.

(d) All floor systems shall be of noncombustible construction.

History: Cr. Register, October, 1974, No. 226, eff. 11-1-74.

ILHR 60.31 Exiting. (1) Each floor shall have not less than 2 exits. All required exits shall lead directly, or through an enclosed stairway, to the outside. FP

(2) The exits shall be located to provide the best possible means of egress.

(3) Travel distance measured along safe passageways between:

(a) Any point in a sleeping room or suite and an exit access door of that room or suite shall not exceed 50 feet;

(b) Any room door intended as an exit access and an exit shall not exceed 50 feet; and

(c) Any point in a room or suite and an exit shall not exceed 100 feet.

(4) The travel distances in sub. (3) shall be reduced by 50% for children under the age of 24 months.

(5) The travel distances in sub. (3) may be increased by 50 feet in buildings completely protected with an automatic fire sprinkler system. No increase in travel distance is permitted for children under the age of 24 months.

(6) Children under the age of 24 months shall be restricted to the first floor, as determined in s. ILHR 51.02 (14), or to ground floors as defined in s. ILHR 51.01 (67).

History: Cr. Register, October, 1974, No. 226, eff. 11-1-74; am. (4), (5) and (6) Register, December, 1977, No. 264, eff. 1-1-78; am. (6), Register, December, 1983, No. 336, eff. 1-1-84; am. (4) and (5), Register, August, 1985, No. 356, eff. 9-1-85.

FP ILHR 60.32 Required exit width. (1) The total required exit width from a building level shall be in accordance with the requirements of ss. ILHR 51.15 (6) and 51.16 (3).

(2) If horizontal exits (s. ILHR 51.19) are provided for any floor, the number of persons accommodated on such floor may be increased at the rate of 100 persons for each 40 inches of width of such exits, provided such increase shall not exceed 100% of the number of persons accommodated by the stairways.

History: Cr. Register, October, 1974, No. 226, eff. 11-1-74; r. and rec. Register, December, 1974, No. 228, eff. 1-1-75.

FP ILHR 60.33 Passageways. (1) The minimum unobstructed width of corridors and passageways shall be determined in the same manner as specified for stairways and exits in s. ILHR 60.32. The minimum width shall be not less than 3 feet 8 inches.

(2) The minimum passageway width shall not be less than 3 feet in existing buildings proposed to be used as day care centers, provided the capacity of the day care center does not exceed 40 persons.

History: Cr. Register, October, 1974, No. 226, eff. 11-1-74.

FP ILHR 60.34 Stair and shaft enclosure. (1) **GENERAL.** Except as provided in sub. (2), all stairs and vertical shafts serving 2 or more floor levels shall comply with the requirements of s. ILHR 51.02 (11) and Table 51.03-A. All required stair enclosures shall lead to the outside without interruption.

(2) **EXCEPTIONS.** (a) Exit stairways serving day care centers located in one story places of worship need not be enclosed.

(b) Exit stairways serving day care centers located in one and two story schools constructed prior to January 1, 1982 need not be enclosed.

(c) Unenclosed stairways, connecting the floor of exit discharge with one adjacent floor level, may be used as required exits for day care centers accommodating 9 to 39 children, provided the stairways are enclosed at all other levels with fire-resistive rated construction equal to or better than the hourly rating specified in Table 51.03-A.

History: Cr. Register, October, 1974, No. 226, eff. 11-1-74; am. (1), Register, October, 1982, No. 322, eff. 11-1-82; r. and rec. Register, August, 1985, No. 356, eff. 9-1-85.

FP ILHR 60.35* Fire extinguishers. Portable fire extinguishers suitable for Class B fires shall be installed in kitchens and cooking areas, and extin-

*See Appendix A for further explanatory material.

guishers suitable for Class A fires shall be installed throughout the remainder of the center.

TABLE 60.35

Basic Minimum Extinguisher Rating for Area Specified	Maximum Travel Distance to Extinguishers (feet)	Area to be Protected per Extinguisher (square feet)
1A	75	3,000
2A	75	6,000
3A	75	9,000
4A	75	11,250
6A	75	11,250

History: Cr. Register, October, 1974, No. 226, eff. 11-1-74.

ILHR 60.36 Fire alarm and detection systems. Every building accommodating more than 20 children shall be provided with a fire alarm system as specified in s. ILHR 51.24 or an approved smoke detection system as specified in s. ILHR 51.245. **FP**

History: Cr. Register, October, 1974, No. 226, eff. 11-1-74; am., Register, December, 1981, No. 312, eff. 1-1-82.

ILHR 60.37 Hazardous areas. Hazardous areas, including boiler or furnace rooms, fuel storage, maintenance shops, woodworking shops, painting areas, and laundries having gas- or oil-fired units with a maximum aggregate input of 37,000 Btu or more, shall be separated from other parts of the building by construction having not less than a one-hour fire-resistive rating. All openings shall be protected by ¾-hour self-closing doors in buildings of 3 stories or less in height. Enclosures shall have a 2-hour fire-resistive rating with 1½-hour "B" label doors in buildings more than 3 stories in height. If the hazard is severe, automatic sprinklers shall be provided in addition to the fire-resistive enclosure when deemed necessary by the department. **FP**

History: Cr. Register, October, 1974, No. 226, eff. 11-1-74.

ILHR 60.38 Exit and emergency lighting. (1) **EXIT LIGHTS.** All required exit doors and exit stairways in day care centers serving more than 20 children shall be plainly marked as specified in s. ILHR 51.15 (5). **FP**

(2) **EMERGENCY POWER SOURCE.** All illuminated exit signs shall be supplied from an emergency source recognized by Ch. E 700, Vol. 2 Wisconsin State Electrical Code, [s. ILHR 16.31] Wis. Adm. Code.

History: Cr. Register, October, 1974, No. 226, eff. 11-1-74; am. (1), Register, May, 1980, No. 293, eff. 6-1-80; am. (1), Register, December, 1983, No. 336, eff. 1-1-84.

Next page is numbered 299

Chapter ILHR 61

COMMUNITY-BASED RESIDENTIAL FACILITIES (CBRF) AND SHELTERED FACILITIES FOR BATTERED WOMEN

ILHR 61.001	Scope (p. 299)	ILHR 61.19	Kitchen and cooking areas (p. 308)
ILHR 61.01	Definitions (p. 300)	ILHR 61.20	Fire extinguishers (p. 308)
ILHR 61.10	Building construction and site (p. 301)	ILHR 61.21	Maintenance and cleanliness (p. 308)
ILHR 61.11	Minimum class of construction (p. 303)	ILHR 61.22	Building service equipment (p. 308)
ILHR 61.12	Exiting and doors (p. 304)	ILHR 61.23	Potable water and plumbing (p. 308)
ILHR 61.13	Sizes of rooms (p. 305)	ILHR 61.24	Heating and ventilating (p. 308)
ILHR 61.14	Smoke detection (p. 305)	ILHR 61.25	Electrical (p. 309)
ILHR 61.15	Windows (p. 306)	ILHR 61.26	Retroactivity (p. 310)
ILHR 61.16	Privacy (p. 306)		
ILHR 61.17	Sanitary facilities (p. 306)		
ILHR 61.18	Requirements for barrier-free environment (p. 306)		

Note: Chapter Ind 60 was renumbered chapter ILHR 60 effective January 1, 1984.

ILHR 61.001 Scope. (1) **CBRF SERVING 9-20.** (a) The requirements of this chapter shall apply to all community-based residential facilities, herein afterwards referred to as CBRF, providing care, treatment and services to 9 through 20 unrelated adults, to be located in existing buildings.

Note: Refer to Ch. HSS 3, rules of the department of health and social services for requirements pertaining to CBRF to be located in existing buildings providing care, treatment and services to 3 through 8 unrelated adults.

(b) Except for s. ILHR 51.01, the requirements of chs. ILHR 51 to 53 and 64 do not apply to existing conditions unless specifically referred to in this chapter. Additions, alterations and remodelings shall conform to the current applicable portions of these chapters.

(2) **NEWLY CONSTRUCTED CBRF.** (a) All newly constructed CBRF providing care, treatment and services for 3 to 8 unrelated adults shall be within the scope of chs. ILHR 20-25.

(b) All newly constructed CBRF providing care, treatment and services for 9 or more unrelated adults shall be within the scope of ch. ILHR 57.

Note #1: This code is not intended to limit the power of cities, villages and towns to make, or enforce, additional or more stringent regulations, provided the regulations do not conflict with this code, or with any other rule of the department or law.

Note #2: CBRF intending to utilize federal funds may have to comply with other requirements in addition to those outlined herein, such as NFPA 101—Life Safety Code, ANSI standards for barrier-free design, and miscellaneous federal regulations.

(3) **SHELTERED FACILITIES FOR BATTERED WOMEN.** (a) The requirements of this chapter shall apply to all sheltered facilities for battered women, as specified in s. 46.95, Stats., serving 20 or less occupants.

(b) Except for s. ILHR 51.01, the requirements of chs. ILHR 51 to 53 and 64 do not apply to existing conditions unless specifically referred to

in this chapter. Additions, alterations and remodelings shall conform to the current applicable portions of these chapters.

Note: Refer to ch. ILHR 57 for sheltered facilities serving more than 20 occupants.

History: Cr. Register, May, 1978, No. 269, eff. 7-1-78; am. Register, October, 1982, No. 322, eff. 11-1-82; correction in (2) (a) made under s. 13.93 (2m) (b) 7, Stats., Register, August, 1985, No. 356.

ILHR 61.01 Definitions. (1) **AMBULATORY.** Ambulatory means able to walk without assistance or difficulty.

(2) **CAPACITY.** The capacity for CBRF is that maximum number of residents as allowed by rules of the department of health and social services.

(3) **CLASSES OF CBRF.** (a) *Class A.* Class A CBRF serve residents all of whom are ambulatory, capable of following directions and taking independent action for self-preservation under emergency conditions.

(b) *Class B.* Class B CBRF serve residents one or more of whom are semiambulatory or nonambulatory, but all of whom are mentally and physically capable of taking independent action for self-preservation under emergency conditions.

(c) *Class C.* Class C CBRF serve residents one or more of whom are not physically or mentally capable of taking independent action for self-preservation under emergency conditions.

(4) **COMMUNITY-BASED RESIDENTIAL FACILITY.** A community-based residential facility is any place where 3 or more unrelated adults reside in which care, treatment or services above the level of room and board but not including nursing care are provided to persons residing in the facility as a primary function of the facility. "Community-based residential facility" does not include a nursing home, except that the department of health and social services may designate a category or categories of intermediate care facilities which serve fewer than 20 residents and which otherwise meet the definition of this subsection to be licensed and regulated as community-based residential facilities. The reception and care or treatment of a person in a convent or facility owned or operated exclusively by and for members of a religious order shall not constitute the premises to be a "community-based residential facility."

(5) **DEPARTMENT.** Department means the department of industry, labor and human relations, unless otherwise designated.

(6) **ELECTRICAL SERVICE.** Electrical service means the conductors and equipment for delivering electrical energy from the supply system to and including the wiring system of the CBRF.

(7) **EXISTING BUILDING.** An existing building, for the purposes of this code (ch. ILHR 61), is one which was constructed and occupied, or ready for occupancy, at least 24 months prior to the date of first application for licensure as a CBRF. Existing buildings which do not satisfy these requirements shall be considered new construction as specified in s. ILHR 61.001 (2).

(7a) **EXISTING BUILDING, CURRENTLY LICENSED.** A facility licensed or certified within 24 months prior to the effective date of these rules (ch. ILHR 61) is considered an existing building for the purposes of this code (ch. ILHR 61).

(8) **FLOORS AND STORIES.** (a) *Attic floor.* Attic floor containing habitable rooms and that are occupied shall be counted as a story.

(b) *Basement floor.* A basement is a floor level partially or totally below grade and not having any required exit for any floor level above it.

(c) *First floor.* The first floor is the lowest floor having one or more required exits for that floor and for any floor above or below it.

(9) **HABITABLE FLOOR SPACE.** Habitable floor space is the area of habitable rooms with a ceiling height more than 5 feet 6 inches, used for the purposes of sleeping, living, cooking or dining.

(10) **HABITABLE ROOM.** A habitable room is any room used for the purposes of sleeping, living, cooking or dining, excluding such places as closets, bath or toilet rooms, pantries, stairways, corridors, service rooms, laundries, utility rooms, cellars or basements unless finished for occupancy, storage spaces, foyers, unfinished attics, administrative offices, garages and similar spaces.

(11) **NONAMBULATORY.** Nonambulatory means not able to walk at all.

(12) **OUTSIDE WINDOWS.** Outside windows are windows which open directly to the out-of-doors or to unheated enclosed spaces, such as exterior balconies or sun porches.

(13) **PRIMARY FUNCTION.** Primary function is the basic or essential care, treatment or service provided to residents of the facility.

(14) **SEMIAMBULATORY.** Semiambulatory means able to walk with difficulty or able to walk only with assistance of aids, such as crutches, canes or walkers.

History: Cr. Register, May, 1978, No. 269, eff. 7-1-78.

ILHR 61.10 Building construction and site. (1) **CONDITION OF BUILDING AND SITE.** All buildings utilized as CBRF shall be structurally sound without visible evidence of structural failure or deterioration.

(a) All courts, yards, or other areas on the premises shall be properly drained or graded to divert water away from the building.

(b) Fences, other minor construction, driveways, parking areas and similar paved areas shall be properly maintained in a safe condition.

(c) Walks shall provide convenient all-weather access to buildings and shall be properly maintained in a safe condition.

(d) Exterior surfaces of buildings and structures not inherently resistant to deterioration shall be treated with a protective coating of paint or other suitable preservative which will provide adequate resistance to weathering. Any exterior surface treated with paint or other preservative shall be maintained so as to prevent chipping, cracking or other deterioration of the exterior surface or the surface treatment. All paint or other preservative shall be applied in a workmanlike fashion. Lead-based paint shall not be used.

(e) Every interior floor, wall and ceiling shall be kept in proper repair. Interior walls and ceiling in spaces subjected to moisture shall be provided with water-resistant, hard surfaces and shall have no serious surface irregularities or cracking.

Note: The use of "indoor-outdoor" carpeting, or other such carpeting approved for application on floors subjected to moisture, is acceptable.

(f) Every foundation wall, exterior wall, floor and roof shall be watertight rodentproof and reasonably weathertight and shall be kept in proper repair.

(g) Every exterior window, exterior door and exterior basement hatchway shall be watertight, rodentproof and reasonably weathertight and kept in proper repair. Every interior door shall be kept in proper repair. All installed door and window hardware shall be maintained in proper working condition.

FP (h) Every inside and outside stair, every porch and every appurtenance to the building shall be so maintained as to be safe in use.

(i) Abrasive strips or nonskid surfaces to reduce or prevent slipping shall be used when slippery surfaces present a hazard.

(2) **GARAGES AND ACCESSORY BUILDINGS.** Garages and accessory buildings located on the same property with a CBRF shall comply with the following:

(a) *Attached garages.* 1. Common walls between a CBRF and an attached garage shall be protected with not less than one layer of 5/8 inch type X gypsum board with taped joints, or equivalent, on the garage side and with not less than one layer of 1/2 inch gypsum board with taped joints, or equivalent, on the CBRF side. Such walls shall provide a complete separation.

2. Floor-ceiling assemblies between garages and CBRF shall be protected with not less than one layer of 5/8 inch type X gypsum board on the garage side of the ceiling or roof framing.

FP 3. Openings between attached garages and CBRF shall be protected by self-closing, 1-3/4 inch solid wood core doors or with self-closing doors of equivalent fire-resistive rating.

Note: A spring of sufficient strength to close the door and activate the door latch will be acceptable for meeting the self-closing portion of this requirement.

4. The level of the garage floor shall be at least 1-1/2 inches below any adjoining floor level.

a. *Exception.* Basement garage floors need not comply with this rule if pitched towards the garage door or provided with a floor drain.

(b) *Detached garages.* 1. Detached garages shall be located a minimum of 3 feet 0 inches from the CBRF.

2. Detached garages less than 3 feet 0 inches from the CBRF shall comply with the requirements for attached garages as found in sub. (2) (a).

(c) *Detached accessory buildings.* 1. Detached accessory buildings in which fueled, motorized vehicles and appliances (snowmobiles, power lawn mowers, motorcycles, snow blowers and similar equipment) are stored shall be located a minimum of 3 feet 0 inches from the CBRF.

2. Detached accessory buildings in which fueled, motorized vehicles and appliances are stored, less than 3 feet 0 inches from the CBRF, shall

comply with the requirements for attached garages as found in sub. (2) (a).

(3) **SMOKE SEPARATION.** (a) A door shall be provided at any interior stair between the basement and the first floor. This door shall be provided with a latch and an automatic closing device and normally be kept closed. FP

(b) Any shaft (clothes chute, dumbwaiter, laundry chute and similar shafts) leading to the basement shall be provided with a door on each level above the lowest floor. The door shall be provided with a latch and an automatic closing device and shall normally be kept closed.

Note: A spring of sufficient strength to close the door and activate the door latch will be acceptable for meeting the automatic closing device portion of these requirements.

History: Cr. Register, May, 1978, No. 269, eff. 7-1-78.

ILHR 61.11 Minimum class of construction. Class of construction for CBRF shall comply with Table 61-1.

TABLE 61-1
MINIMUM CLASS OF CONSTRUCTION (s. ILHR 51.03)

Number of Stories	Minimum Type of Construction for Class of CBRF		
	Class A	Class B	Class C
1	8	8	3(c),(d)
2	8	8(b),(c)	2(e)
3	5(a)	2(d)	2
4	5	2	2
5 to 8	2	2	2
Over 8	1	1	1

(a) Type 8 construction will be permitted if the basement is protected by a complete automatic sprinkler system or if all ceilings, including basements, are completely protected with ½ inch gypsum wallboard, or equivalent, and all stairway exits are interior stairs, one of which is completely enclosed, with at least one-hour rated construction, to a first-story outside exit.

(b) Type 8 construction will be permitted if building is protected by a complete automatic sprinkler system or if only ambulatory residents are permitted above the first story and in the basement.

(c) Types 5 and 6 construction will be permitted if of totally noncombustible construction.

(d) Type 8 construction will be permitted if building is protected by a complete automatic sprinkler system and provided only ambulatory residents are permitted above the first story and in the basement.

(e) Types 3, 5 and 6 construction will be permitted if of totally noncombustible construction and the building is protected by a complete automatic sprinkler system.

Note: The following brief descriptions of construction types are included as guidelines only. Designers and builders should refer to s. ILHR 51.03 and Table 51.03-A for detailed descriptions and requirements for the various construction types.

Type 8 — Wood framed walls, floors, roofs and partitions, including wood framed exterior walls faced with masonry veneers (typical residential construction).

Type 6 — Metal framed walls and roofs with steel structural framing; sheet metal covered exterior walls and roof (typical pre-engineered metal building).

Type 5 — Exterior walls entirely of masonry (concrete block, brick, concrete, etc.); floor and roof systems of wood, steel or concrete; interior partitions are wood framed. (Buildings with wood floor and roof systems or with wood framed partitions are not considered noncombustible.)

Type 3 — Totally noncombustible building with floors, roof and structural framing protected with hourly rated fireproofing material.

Types 2 and 1 — The same as Type 3 but with higher degrees for fireproofing.

History: Cr. Register, May, 1978, No. 269, eff. 7-1-78.

FP ILHR 61.12 Exiting and doors. (1) **NUMBER, TYPE AND ACCESS TO EXITS.** (a) All CBRF, and each floor level having habitable rooms, shall have at least 2 means of exit which provide unobstructed travel to the outside at street or grade level.

1. *Exception.* A single exit will be permitted from basements or attics utilized for recreational, nonsleeping purposes only.

2. A wooden balcony or a flat roof, within 10 feet of grade, or an exterior wood stair may serve as one of the required exits from the second floor of a 2-story CBRF, except Class B and C CBRF with nonambulatory residents on the second floor.

(b) Exits shall be standard exits to grade (doors), stairways as specified in sub. (3), or fire escapes. (See exception under sub. (1) (a) 1.)

(c) No exit passageway shall be through a private room or bath/toilet room.

(d) Exit passageways and stairways to the outside exits shall be at least 3 feet wide, except existing secondary exit passageways, stairways and doors may be reduced to 2 feet 4 inches in width.

(e) The required width shall be maintained clear and unobstructed at all times.

(2) **DOORS.** (a) Outside exit doors and doors in exit access corridors shall be at least 2 feet 8 inches in width, except as provided in sub. (1) (d) for existing secondary exit doors.

(b) All doors shall have such fastenings or hardware that they can be opened from the inside with one hand without the use of a key.

(c) Closet doors shall be openable from the inside.

(d) All interior doors equipped with locks shall be designed to permit opening of the locked doors from either side in case of emergency.

(3) **STAIRS: GENERAL.** (a) *Treads and risers.* All required interior and exterior exit stairways shall have a minimum tread width (exclusive of nosing or projection) of 9 inches and a maximum riser height of 8 inches.

1. *Exception.* Stairs serving basements and attics without habitable rooms may have a minimum tread width (exclusive of nosing or projection) of 8 inches and a maximum riser height of 9 inches.

(b) *Handrails.* One or more handrails, at least 29 inches above the nose of the tread, shall be provided on all stairways. Handrails shall be provided on the open sides of stairways and platforms.

(c) *Winder stairs.* 1. Winders in stairways shall be provided with handrails on both sides, at least 29 inches above the nose of the tread.

2. Winders in stairways used as required exits shall have treads of at least 7 inches in width at a point one foot from the narrow end of the tread.

(d) *Spiral stairs.* Spiral stairs shall be prohibited for use as required exit stairs.

(4) **STAIRS: ENCLOSURE.** (a) Three-story CBRF shall have at least one stairway exit, enclosed with at least one-hour rated construction, leading to a first-story outside exit.

(b) CBRF, 4 or more stories in height, shall have all stairways enclosed with at least one-hour rated construction. All required exit stairways shall have such enclosures leading to a first-story outside exit.

Note: Buildings of Type 1 and 2 construction require 2-hour rated stair enclosures in accordance with s. ILHR 51.03 (1) and (2).

(5) **ILLUMINATION.** All exit passageways and stairways shall be capable of being illuminated at all times.

History: Cr. Register, May, 1978, No. 269, eff. 7-1-78.

ILHR 61.13 Sizes of rooms. (1) **HABITABLE FLOOR SPACE.** (a) Each sleeping room for ambulatory residents shall contain not less than 60 square feet of habitable floor space; and each sleeping room for semiambulatory or nonambulatory residents shall contain not less than 90 square feet of habitable floor space.

(b) In addition to the area required in sub. (1) (a), the CBRF shall provide habitable floor space, other than sleeping rooms, of not less than 60 square feet of area for each ambulatory resident and of not less than 90 square feet in area for each semiambulatory or nonambulatory resident.

(c) All habitable rooms shall have an average ceiling height of not less than 7 feet 0 inches.

History: Cr. Register, May, 1978, No. 269, eff. 7-1-78.

ILHR 61.14 Smoke detection. (1) **GENERAL.** All CBRF within the scope of this chapter shall be provided with an approved smoke detection system. **FP**

(2) **TYPE OF SYSTEM.** The smoke detection system specified in sub. (1) shall be at least a low voltage interconnected smoke detection system designed to protect the entire facility and capable of sounding an alarm throughout the facility or at a central location upon activation of any smoke detector.

(3) **SMOKE DETECTOR LOCATION.** At least 1 approved interconnected smoke detector shall be provided at the following locations:

(a) At the head of every open stairway;

(b) At the door leading to every enclosed stairway on each floor level;

(c) In every corridor, spaced not more than 30 feet apart and not further than 15 feet from any wall;

(d) In each common use room, including living rooms, dining rooms, family rooms, lounges and recreation rooms but not including kitchens; and

(e) In each sleeping room in which smoking is allowed.

Register, August, 1985, No. 356

(4) **APPLICABILITY.** The provisions of this section shall apply to all CBRF constructed on or after the effective date of this section and to those CBRF previously constructed.

Note: See s. ILHR 61.245 for additional requirements pertaining to smoke detectors.

History: Cr. Register, May, 1978, No. 269, eff. 7-1-78; r. and recr. Register, December, 1978, No. 276, eff. 1-1-79; am., Register, December, 1981, No. 312, eff. 1-1-82, except (2) eff. 1-1-83; r. and recr. Register, August, 1985, No. 356, eff. 9-1-85.

ILHR 61.15 Windows. (1) **MINIMUM SIZE.** Every living and sleeping room shall have outside window(s) with a total sash area of at least 10% of the floor area of the room. The openable area of such windows shall be equal to not less than 5% of the floor area of the room served.

(2) **MINIMUM OPENING FOR SLEEPING ROOMS.** At least one window in each sleeping room shall be openable from the inside without the use of tools and shall provide a clear opening of not less than 16 inches in the least dimension.

(3) **STORM WINDOWS AND SCREENS.** All windows serving habitable rooms shall be provided with storm windows in winter and openable windows serving habitable rooms shall be provided with insect-proof screens in summer.

(a) *Exception.* Insulated windows need not be provided with storm windows.

History: Cr. Register, May, 1978, No. 269, eff. 7-1-78.

ILHR 61.16 Privacy. Privacy for sleeping rooms shall be provided by full-height partitions and rigid, swing-type room doors.

History: Cr. Register, May, 1978, No. 269, eff. 7-1-78.

ILHR 61.17 Sanitary facilities. (1) **BATH AND TOILET ROOMS.** (a) Every CBRF shall have at least 2 separate bath and toilet rooms, or combination bath/toilet rooms, which are accessible from public (non-sleeping) areas.

(b) Door locks shall be provided to ensure privacy.

(2) **NUMBER OF FIXTURES.** Every CBRF shall have at least 2 water closets (toilets), 2 lavatories (sinks) connected to hot and cold water and 2 bathing facilities (bathtubs or showers) connected to hot and cold water; however, the ratio of occupants to water closets and lavatories shall be not less than one water closet and one lavatory per 8 occupants.

(3) **LOCATION OF BATH AND TOILET ROOMS.** Bath and toilet rooms shall be so distributed that the maximum vertical travel distance to them from sleeping rooms is not more than one floor level.

History: Cr. Register, May, 1978, No. 269, eff. 7-1-78.

ILHR 61.18 Requirements for barrier-free environment. (1) **SCOPE.** The requirements of this section are intended to ensure that all CBRF licensed for mentally retarded or physically disabled residents shall be accessible and usable by such residents.

(2) **DEFINITIONS.** (a) *Primary floor.* The primary floor is any floor level at least 50% of which is used for habitable floor space.

Register, August, 1985, No. 356

(3) REQUIREMENTS FOR ACCESSIBILITY. All CBRF shall comply with the requirements found in Table 61.18.

TABLE 61.18

Barrier-Free Requirements	Class of CBRF		
	A	B	C
Ramped or grade-level entrance from street, alley or ancillary parking to a primary floor	Not required	Not required ¹	Required
Stepped entrance to a primary floor within 2'-0" of grade	Not required	Required ¹	Not permitted
All passageway doors on primary floor minimum 2'-8" wide.....	Not required	Not required ^{2, 3}	Required
All passageway doors on primary floor minimum 2'-6" wide.....	Not required	Required ²	Not permitted ³
Elevators, ramps or lifts to other floor levels	Not required	Required ⁴	Required ⁴
Interior access to all common-use areas.....	Not required	Required	Required
Interior access to at least one bathing and toilet facility.....	Not required	Required	Required
Grab bars for toilet and bath fixtures	Not required	Required ⁵	Required ⁵
Compliance with s. ILHR 52.04 (8)...	Not required	Required ⁶	Required ⁶

¹Ramped or grade-level entrance required if residents are not capable of negotiating stairs.

² 8" doors required if residents in wheelchairs are allowed.

³ 2' 6" sleeping room doors permitted for rooms used by ambulatory residents.

⁴May be omitted if use of other floors is restricted to ambulatory or semiambulatory residents physically capable of negotiating stairs or if there are no one-of-a-kind, common-use areas located on those floors.

⁵Not required in rooms used only by ambulatory residents.

⁶Not required in rooms used only by ambulatory residents or residents not confined to a wheelchair.

(4) RAMP REQUIREMENTS. Ramps, as required in Table 61.18, shall **FP** comply with the following:

(a) *Ramp slope.* Ramps shall have a slope of not more than one foot of rise in 12 feet of run. An interior ramp with a slope of one foot of rise in 8 feet will be permitted. The ramps shall have a slip-resistant surface and shall have no side slope;

(b) *Ramp width.* Ramps shall be at least 4 feet wide, of which not more than 4 inches on each side may be occupied by a handrail;

(c) *Ramp handrails.* Ramps shall have a handrail on each side which shall be at least 2 feet 6 inches high (preferable height, 2 feet 8 inches). Handrails on unenclosed ramps shall include an intermediate parallel rail at mid height;

(d) *Ramp clearance.* Where ramps are provided to doorways, the ramp on each side of the doorway shall be level for a distance of 5 feet from the door; and

(e) *Ramp platforms.* Ramps having a 1:8 slope shall have a 5-foot long level platform at 16-foot intervals. Ramps having a 1:12 slope shall have a level platform at 30-foot intervals. Both types of ramps shall have a

level platform at least 5 feet long where they turn and at least 5 feet of level clearance at the bottom of the ramps.

History: Cr. Register, May, 1978, No. 269, eff. 7-1-78.

ILHR 61.19 Kitchen and cooking areas. All CBRF shall have a kitchen or an area set aside for cooking and dining accessible from public (non-sleeping) areas. Kitchens or cooking areas shall be provided with one sink, in good working condition, connected to hot and cold water; utility service connections; and space for a stove and a refrigerator.

History: Cr. Register, May, 1978, No. 269, eff. 7-1-78.

FP ILHR 61.20 Fire extinguishers. A portable, dry chemical fire extinguisher, with a minimum 2A, 10 B-C rating, shall be provided on each occupied floor level. On the floor containing the kitchen, the fire extinguisher shall be located in the kitchen or cooking area.

History: Cr. Register, May, 1978, No. 269, eff. 7-1-78; am. Register, August, 1985, No. 356, eff. 9-1-85.

ILHR 61.21 Maintenance and cleanliness. All CBRF, and all parts thereof, shall be maintained and kept in good repair, shall be kept clean, and shall also be kept free from any accumulation of dirt, trash or debris.

History: Cr. Register, May, 1978, No. 269, eff. 7-1-78.

ILHR 61.22 Building service equipment. Each gas line providing service piping connections for appliances shall have a separate shut-off (stop cock) for each appliance served.

History: Cr. Register, May, 1978, No. 269, eff. 7-1-78.

ILHR 61.23 Potable water and plumbing. Where a public water supply is available it shall be used to provide a continuing and adequate supply of potable water. When a public water system is not available the well, or wells, shall be approved by the department of natural resources. Water samples from an approved well shall be tested at the state laboratory of hygiene, or a state approved laboratory, at least annually. The water supply shall be bacteriologically safe prior to use.

Note: Refer to ch. ILHR 82 for requirements pertaining to the plumbing system.

History: Cr. Register, May, 1978, No. 269, eff. 7-1-78.

FP ILHR 61.24 Heating and ventilating. (1) **HEATING.** (a) *General.* All occupied rooms in CBRF shall be provided with a permanently connected heating system.

(b) *Operation and maintenance.* 1. The heating system shall be maintained in a clean and safe condition. A minimum temperature, as specified in the licensing rules, shall be maintained in all CBRF.

2. Replacement equipment shall be of an approved type.

Note: The department recognizes listings of independent testing agencies such as American Gas Association (AGA) and Underwriters' Laboratories (UL).

(c) *Chimneys and breeching.* 1. Chimneys (masonry or factory-built) and breeching shall be kept in good repair and shall be of the type required for the type of connected heating equipment.

2. Every chimney shall be provided with an access panel to permit inspection and servicing.

Register, August, 1985, No. 356

(d) *Clearance to combustibles and combustible construction.* 1. Heating equipment shall be installed in accordance with the manufacturer's recommendations to provide minimum clearance. In the absence of manufacturer's recommendations, a minimum clearance of 36 inches shall be provided.

a. Exception: Existing installations providing less than 36 inches of clearance will be accepted if there is no physical evidence of problem (charring, etc.).

2. New combustible construction, such as partitions, shelving or storage lockers, shall not encroach upon the required clearance.

(e) *Safety features.* 1. All oil- and gas-fired equipment shall be provided with automatic controls that will shut off the fuel supply to the burner in case of ignition failure.

2. Steam boilers shall be provided with pressure gauge and safety valve.

3. Hot-water boilers shall be provided with pressure-temperature relief valve.

4. Fixed electric heating equipment shall be of a type equipped with safety and temperature controls.

5. Gas-fired fireplaces shall be provided with automatic controls that will shut off the fuel supply in case of flame-out and shall be properly vented.

6. Solid-fuel fireplaces shall be equipped with safety screen.

(f) *Space heaters.* Portable and fixed fuel-fired, and portable electric space heaters are prohibited in CBRF.

1. *Exception.* Fixed, gas-fired pre-vented wall heaters may be used.

(2) **VENTILATION: GENERAL REQUIREMENTS.** (a) *Kitchen or cooking areas.* Kitchens or cooking areas shall be provided with at least one openable outside window, an exhaust fan vented to the outside, or a means of filtered mechanical air circulation.

(b) *Bath and toilet rooms.* Bath and toilet rooms shall have at least one openable outside window at least 2 square feet in area, or a mechanical or gravity exhaust vented to the outside, or an approved ductless exhaust fan.

History: Cr. Register, May, 1978, No. 269, eff. 7-1-78.

ILHR 61.25 Electrical. (1) **GENERAL.** (a) Every CBRF shall be supplied with electrical service, wiring, outlets and fixtures which shall be properly installed and shall be maintained in good and safe working condition. **FP**

(b) The electrical service shall be of the proper size to handle the load connected to it.

Note: As a guide to the owner/operator for determining the adequacy of existing electrical service, the habitable rooms should have electrical service capable of providing at least 3 watts per square foot of total floor area in addition to that provided for air conditioning, ranges, fixed electric heaters and motor-driven equipment $\frac{1}{2}$ hp or over.

(2) **PROTECTION.** The branch circuits shall be protected by S-type or equivalent safety type, tamper-proof fuses, or circuit breakers not to exceed the ampacity of the smallest wire size in the circuit.

(3) **MINIMUM NUMBER OF FIXTURES AND OUTLETS.** The minimum number of fixtures and outlets shall be as follows:

(a) Every lavatory, bathroom, kitchen or kitchenette, dining room, laundry room, and furnace room shall contain at least one approved ceiling or wall-type electric light fixture equipped with sufficient lamps or tubes to provide no less than 5 footcandles at floor level at center of room. Where more than one fixture is used or required, they shall be equally spaced as far as practicable. (A switched outlet may be substituted for ceiling or wall fixture in lavatories, bathrooms and dining rooms.); and

(b) Electric duplex outlet receptacles shall be provided as follows. (To determine room area, measurements shall be taken at room perimeter and shall include doors and door-alcoves.)

1. Living room, one per 75 sq. ft. of floor area or major fraction (minimum of 2).

2. Dining room, one per 75 sq. ft. of floor area or major fraction (minimum of 2).

3. Kitchen, one per 8 lineal feet or fraction of countertop and preparation area, including island-type areas. In addition, kitchens used for dining purposes, one per 75 sq. ft. of floor area or major fraction. Separate outlets shall be provided for refrigerators.

Note: Preparation areas include countertops and all other similar areas at counter height.

4. Bedroom, one per 75 sq. ft. of floor area or major fraction (minimum of 2).

5. Laundry, one.

6. Toilet rooms, one (may be part of wall fixture if 72 inches or less from floor).

7. Other habitable rooms, minimum of 2.

(4) **OUTLET AND SWITCH LOCATIONS; EXPOSED WIRING.** (a) *Outlets.* Convenience outlets shall be located to discourage use of extension cords.

(b) *Switches.* Switches or equivalent devices for turning on one light in each room or passageway shall be located so as to conveniently control the lighting in the area.

(c) *Exposed wiring.* All temporary wiring and exposed, abandoned wiring shall be removed.

History: Cr. Register, May, 1978, No. 269, eff. 7-1-78.

ILHR 61.26 Retroactivity. The rules of this chapter shall apply to buildings with occupancies under the scope of this chapter now in existence and to buildings hereafter converted to use as a CBRF.

History: Cr. Register, May, 1978, No. 269, eff. 7-1-78.

Chapter ILHR 62

SPECIALTY OCCUPANCIES

- | | | | |
|---|---|---|--|
| ILHR 62.001 | Scope (p. 311) | ILHR 62.50 | Fire extinguishers (p. 319) |
| ILHR 62.10 | Definitions (p. 312) | ILHR 62.51 | Illumination; exit lights and signs (p. 320) |
| Subchapter I Open Parking Structures | | | |
| ILHR 62.20 | Scope (p. 312) | Subchapter IV Outdoor Theaters | |
| ILHR 62.205 | Classifications (p. 312) | ILHR 62.52 | Scope (p. 320) |
| ILHR 62.21 | Construction requirements (p. 312) | ILHR 62.53 | Entrances and exits (p. 320) |
| ILHR 62.22 | Setbacks (p. 313) | ILHR 62.54 | Vehicle storage (p. 321) |
| ILHR 62.23 | Separation from other occupancies (p. 313) | ILHR 62.55 | Tower construction (p. 321) |
| ILHR 62.24 | Construction, height and allowable area (p. 313) | ILHR 62.56 | Location of tower (p. 321) |
| ILHR 62.25 | Clearance limitations (p. 313) | ILHR 62.57 | Concession and motion picture machine booth (p. 321) |
| ILHR 62.26 | Number, location and type of pedestrian exits (p. 314) | ILHR 62.58 | Sanitary equipment (p. 321) |
| ILHR 62.27 | Stairway enclosures (p. 314) | ILHR 62.59 | Ramps and speaker equipment (p. 321) |
| ILHR 62.28 | Pedestrian and perimeter guardrails (p. 314) | ILHR 62.60 | Lighting (p. 322) |
| ILHR 62.29 | Illumination and exit lights (p. 315) | ILHR 62.61 | Speed limit (p. 322) |
| ILHR 62.30 | Standpipes (p. 315) | ILHR 62.62 | Running of engines (p. 322) |
| ILHR 62.31 | Sanitary facilities (p. 315) | Subchapter V Assembly Seating Facilities | |
| ILHR 62.32 | Isolation of hazards (p. 316) | ILHR 62.70 | Scope (p. 322) |
| ILHR 62.33 | Exceptions for mechanical access open parking structures (p. 316) | ILHR 62.71 | Approval and supervision (p. 322) |
| ILHR 62.34 | Barrier-free requirements (p. 316) | ILHR 62.72 | Inspection and maintenance (p. 323) |
| Subchapter II Television and Radio Antenna | | | |
| ILHR 62.35 | Scope (p. 316) | ILHR 62.73 | Design loads (p. 323) |
| ILHR 62.36 | Construction requirements (p. 316) | ILHR 62.74 | Construction requirements (p. 324) |
| ILHR 62.37 | Design loads (p. 317) | ILHR 62.75 | Means of egress (p. 325) |
| ILHR 62.38 | Antenna systems on buildings (p. 317) | ILHR 62.76 | Seating (p. 327) |
| ILHR 62.39 | Setbacks (p. 317) | ILHR 62.77 | Guardrails (p. 327) |
| ILHR 62.40 | Antenna system support (p. 317) | ILHR 62.78 | Isolation of hazards (p. 328) |
| ILHR 62.41 | Electrical requirements (p. 317) | ILHR 62.79 | Sanitary facilities (p. 328) |
| Subchapter III Tents | | | |
| ILHR 62.42 | Scope (p. 318) | ILHR 62.80 | Illumination and emergency lighting (p. 329) |
| ILHR 62.43 | Area limitation and setbacks (p. 318) | ILHR 62.81 | Fire prevention (p. 329) |
| ILHR 62.44 | Structural requirements (p. 318) | Subchapter VI Greenhouses | |
| ILHR 62.45 | Flame resistance (p. 318) | ILHR 62.90 | Scope (p. 329) |
| ILHR 62.46 | Fire hazards (p. 318) | ILHR 62.91 | Classifications (p. 329) |
| ILHR 62.47 | Exits (p. 319) | ILHR 62.92 | Construction (p. 329) |
| ILHR 62.48 | Toilet facilities (p. 319) | ILHR 62.93 | Separations (p. 330) |
| ILHR 62.49 | Electrical installations (p. 319) | ILHR 62.94 | Height and allowable area (p. 330) |
| | | ILHR 62.95 | Exits (p. 330) |
| | | ILHR 62.96 | Design loads (p. 330) |
| Subchapter VII Pedestrian Access Structures Connecting Buildings | | | |
| | | ILHR 62.97 | Scope (p. 332) |
| | | ILHR 62.98 | General requirements (p. 332) |
| | | ILHR 62.99 | Exiting (p. 334) |
| | | ILHR 62.991 | Special requirements (p. 334) |

Note: Chapter Ind 62 was renumbered chapter ILHR 62 effective January 1, 1984.

ILHR 62.001 Scope. This classification includes all specialty occupancies as indicated in the scope of each subchapter of this chapter.

History: Cr. Register, December, 1977, No. 264, eff. 1-1-78; am. Register, December, 1981, No. 312, eff. 1-1-82.

ILHR 62.10 Definitions. (1) "Assembly seating facilities" means structures including but not limited to, bleachers, grandstands and stadiums on which persons are seated for such purposes as entertainment, worship or deliberation.

(1m) "Greenhouses" means structures clad with light-transmitting material designed primarily for the purpose of cultivating plant life and used as public buildings or places of employment.

(2) "Open parking structure" means a structure with open areas in the exterior walls or ventilation shafts, or combination of both, as specified in s. ILHR 62.21 used solely for the parking of passenger vehicles without any facilities for repairing or fueling of vehicles within the structure.

(3) "Outdoor theater" means a place of outdoor assembly used for the showing of plays, operas, motion pictures and similar forms of entertainment in which the audience views the performance from self-propelled vehicles parked within the theater enclosure.

(4) "Permanent" means in place for more than 180 consecutive calendar days.

(5) "Repair garage" means a structure as defined in s. ILHR 59.01 (4).

(6) "Storage garage" means a structure as defined in s. ILHR 59.01 (5).

(7) "Tents" mean portable, temporary shelters or structures, the covering of which is made of pliable material.

History: Cr. Register, December, 1977, No. 264, eff. 1-1-78; cr. (3) and (4), Register, January, 1980, No. 289, eff. 2-1-80; r. and recr., Register, December, 1981, No. 312, eff. 1-1-82; cr. (1m), Register, December, 1983, No. 336, eff. 1-1-84.

Subchapter I — Open Parking Structures

ILHR 62.20 Scope. This subchapter provides the minimum requirements for the design and construction of open parking structures as specified in s. ILHR 62.10 (2).

History: Cr. Register, December, 1977, No. 264, eff. 1-1-78; am., Register, December, 1981, No. 312, eff. 1-1-82.

ILHR 62.205 Classifications. Open parking structures shall be classified as either ramp access or mechanical access types as follows:

(1) Ramp access, open parking structures employ a series of continually sloped floors or a series of interconnected ramps between floors permitting the movement of vehicles under their own power between the street level and parking areas; or

(2) Mechanical access, open parking structures employ fully automated parking machines, lifts, elevators or other mechanical devices for moving vehicles between the street level and the parking area, and in which public occupancy is prohibited above street level.

History: Cr. Register, December, 1981, No. 312, eff. 1-1-82.

ILHR 62.21 Construction requirements. (1) **GENERAL.** Open parking structures shall be provided with open areas in the exterior walls or ventilation shafts, or a combination of both, on each level of at least 4% of Register, August, 1985, No. 356

the total floor area of that level, distributed on at least 2 exterior sides so as to provide cross ventilation.

(2) **MATERIAL.** All open parking structures shall be constructed of noncombustible materials.

Note: Structural components of open parking structures are subjected to corrosive and deteriorating elements. The designer should consider the effects of such elements and should consider the use of air-entrained concrete, concrete sealers and coatings, additional cover for reinforcing and other accepted engineering practices to protect the components.

(3) **FLOORS.** Floors shall be provided with drainage as specified in s. ILHR 82.36.

History: Cr. Register, December, 1977, No. 264, eff. 1-1-78; r. and rec. Register, December, 1981, No. 312, eff. 1-1-82; correction in (3) made under s. 13.93 (2m) (b) (7), Stats., Register, August, 1985, No. 356.

ILHR 62.22 Setbacks. Open parking structures may be erected without enclosing walls, except that enclosing walls of not less than 2-hour fire-resistive construction, as specified in s. ILHR 51.04, shall be provided on all sides which are less than 10 feet from a property line between premises or any other building.

History: Cr. Register, December, 1977, No. 264, eff. 1-1-78.

ILHR 62.23 Separation from other occupancies. Every open parking structure shall be separated from any other occupancy by noncombustible 2-hour (NC-2) rated construction, or better, except as specified in s. ILHR 55.05. (With respect to s. ILHR 55.05, open parking structures are considered nonhazardous.) All openings in the wall to adjoining occupancies shall be protected by means of self-closing, fire-resistive doors as specified in s. ILHR 51.047.

Note: It is also the intent of this section to consider office and building maintenance areas used in conjunction with the operation of the open parking structure as distinct occupancies requiring 2-hour separation.

History: Cr. Register, December, 1977, No. 264, eff. 1-1-78.

ILHR 62.24 Construction, height and allowable area. (1) **CONSTRUCTION AND HEIGHT.** Open parking structures shall be of the type of construction and shall not exceed the height as specified in this section. The maximum floor area of any such structure shall not exceed that permitted for the corresponding type of construction and height as follows:

(a) Open parking structures of noncombustible zero-hour (NC-0) rating shall not exceed 70 feet in height or 700,000 square feet in total area.

(b) Open parking structures of noncombustible 2-hour rating or better shall not be limited in height or area per floor level. Exterior walls need not be rated, except as provided in s. ILHR 62.22.

Note: Open parking structures in excess of 60 feet in height are exempt from the administrative rules and statutes requiring automatic fire sprinkler systems (see s. ILHR 52.01 (1) and (2) and s. 101.14, Stats.).

History: Cr. Register, December, 1977, No. 264, eff. 1-1-78; am. (1) (intro.), Register, December, 1981, No. 312, eff. 1-1-82.

ILHR 62.25 Clearance limitations. (1) * **PRINCIPAL VEHICLE AND PEDESTRIAN TRAFFIC AREAS.** The clear height of each floor level in principal vehicle and pedestrian traffic areas shall be not less than 7 feet 0 inches.

*See Appendix A for further explanatory material.

(2) **CLEARANCE SIGNS.** Clearance limitation signs shall be prominently posted at all vehicle entrances.

Note: A lesser clear height may be permitted in mechanical-access open parking structures when approved by the department.

History: Cr. Register, December, 1977, No. 264, eff. 1-1-78.

FP ILHR 62.26 Number, location and type of pedestrian exits. (1) **NUMBER OF EXITS.** Every open parking structure and every floor level thereof shall have at least 2 exits.

(2) **DISTANCE TO EXITS.** Additional exits shall be provided so that no part of the open parking structure will be more than 200 feet distant to the exit discharge grade or to a stair enclosure if the walls separating the stair from the open parking structure are of at least noncombustible one-hour (NC-1) rating or better and the enclosure is continuous to an outside exit.

Note: In all cases, required exit stairs are required to be enclosed (see s. ILHR 62.27). If the designer elects to increase the exit distance by measuring to the stair enclosure, the enclosure must have at least a noncombustible one-hour (NC-1) rating.

(3) **LOCATION OF EXITS.** Exits in all open parking structures shall be placed as far apart as practicable and so located that if any exit is blocked, some other exit will still be available from every part of the structure.

(4) **TYPE OF EXITS.** At least one-half of the exits required by this section shall be standard exits to grade, stairways or horizontal exits as specified in ss. ILHR 51.15, 51.16 and 51.19, respectively. The other exits may be non-parking access ramps with a maximum slope of 1:8.

History: Cr. Register, December, 1977, No. 264, eff. 1-1-78; am. (4), Register, December, 1978, No. 276, eff. 1-1-79; am. (4), Register, January, 1980, No. 289, eff. 2-1-80.

ILHR 62.27 Stairway enclosures. Stair enclosures of NC-0 hour rating, or better, shall be provided for all required exit stairways, unless otherwise required to be rated.

Note: It is the intent of s. ILHR 62.27 to require all required exit stairs to be enclosed. If the designer elects to measure the exit distance to the stair enclosure, the enclosure must be then rated. (See s. ILHR 62.26 (2).)

History: Cr. Register, December, 1977, No. 264, eff. 1-1-78.

ILHR 62.28 Pedestrian and perimeter guardrails. (1) **PEDESTRIAN GUARDRAILS.** (a) Pedestrian guardrails, or equivalent, conforming to the requirements of s. ILHR 51.162, shall be provided on all open sides of the structure on each level.

(b) Pedestrian guardrails as specified in s. ILHR 62.28 (1) (a) shall be provided at changes of elevation within the structure where the clear vertical opening at the elevation change is one foot 6 inches or greater.

(2) **PERIMETER GUARDRAILS.** (a) Perimeter guardrails shall be installed at the end of drive lanes and shall be designed for a minimum horizontal live load of 1000 pounds per lineal foot acting at 18 inches above the floor level.

Register, August, 1985, No. 356

(b) Perimeter guardrails shall be installed at the end of parking stalls and shall be designed for a minimum horizontal live load of 500 pounds per lineal foot acting at 18 inches above the floor.

History: Cr. Register, December, 1977, No. 264, eff. 1-1-78; am. (1), Register, January, 1980, No. 289, eff. 2-1-80.

ILHR 62.29 Illumination and exit lights. (1) **ILLUMINATION LEVELS.** Minimum illumination levels at a horizontal plane 30 inches above the floor shall conform to the requirements of Table 62-I.

FP

(2) **EXIT LIGHTS.** Every required exit from each floor shall be indicated by an approved exit sign as specified in s. ILHR 51.15 (5).

TABLE 62-I
 MINIMUM ILLUMINATION LEVELS

Area	Intensity (in footcandles)
Stairways and exits	10
Parking areas	2

History: Cr. Register, December, 1977, No. 264, eff. 1-1-78; am. (2), Register, December, 1983, No. 336, eff. 1-1-84.

ILHR 62.30 Standpipes. (1) **FIRE DEPARTMENT STANDPIPES.** Except as provided in sub. (2), fire department standpipes shall be provided in all open parking structures 3 or more stories in height.

FP

(a) Fire department standpipes shall be dry standpipes systems.

(b) Fire department standpipes with a fire department connection greater than 50 feet to a street shall be interconnected to a standpipe system with such a connection 50 feet or less to a street.

(c) Fire department standpipes shall be provided in each stair enclosure and shall be provided with approved 2½ inch valve hose connections at each flow level with one valve connection in the stair enclosure and one valve connection immediately outside the enclosure.

(d) Fire department standpipes shall be as specified in s. ILHR 51.21 (3) (e) to (i).

(2) **EXCEPTIONS.** (a) The department will recognize alternative systems and designs if an equivalent degree of safety is provided in lieu of required fire department standpipes in open parking structures 60 feet or less in height.

(b) The department will accept open parking structures without fire department standpipes if clearances are provided to allow fire-fighting vehicles access throughout the open parking structure.

History: Cr. Register, December, 1977, No. 264, eff. 1-1-78; am. (1) (d) 2., Register, December, 1978, No. 276, eff. 1-1-79; r. and recr., Register, December, 1981, No. 312, eff. 1-1-82.

ILHR 62.31 Sanitary facilities. (1) **UNATTENDED PARKING STRUCTURES.** Sanitary facilities need not be provided in unattended parking structures.

(2) **ATTENDED PARKING STRUCTURES.** Sanitary facilities for employes shall be provided in accordance with s. ILHR 54.12 in attended parking structures.

Note: Sanitary facilities for patrons need not be provided.

History: Cr. Register, December, 1977, No. 264, eff. 1-1-78.

FP ILHR 62.32 Isolation of hazards. (1) **FIRE PROTECTION.** (a) Except as provided in par. (b), boilers, furnaces, including fuel rooms and breeching, and all open-flame equipment within open parking structures shall be isolated from the rest of the open parking structure by at least 2-hour fire-resistive construction as specified in ss. ILHR 51.04 to 51.049.

(b) Direct vent sealed combustion chamber appliances and suspended heating equipment as specified in Table 64.21 need not be enclosed with fire-resistive construction as specified in par. (a).

(2) **PROTECTION OF OPENINGS.** All openings in such enclosure shall be protected with self-closing fire-resistive doors as specified in s. ILHR 51.047.

(3) **SUSPENDED EQUIPMENT.** Space heaters, suspended furnaces, and direct-fired unit heaters, fired with various fuels, may be used without an enclosure where approved by the department. Where such equipment is used without an enclosure, they shall be located at least 8 feet above the floor.

History: Cr. Register, December, 1977, No. 264, eff. 1-1-78; am. (1), Register December, 1981, No. 312, eff. 1-1-82; am. (1), Register, August, 1985, No. 356, eff. 1-1-86.

ILHR 62.33 Exceptions for mechanical access open parking structures. Mechanical access open parking structures need not comply with ss. ILHR 62.25 - 62.29, inclusive.

History: Cr. Register, December, 1977, No. 264, eff. 1-1-78.

ILHR 62.34 Barrier-free requirements. (1) **PARKING SPACES.** Accessible parking spaces shall be provided in accordance with the applicable requirements specified in s. ILHR 52.04 (3) (a).

(2) **TOILET FACILITIES.** Toilet facilities provided for the employes, as specified in s. ILHR 62.31 (2), shall comply with the requirements of s. ILHR 52.04 (4) (c).

History: Cr. Register, December, 1978, No. 276, eff. 1-1-79.

Subchapter II—Television and Radio Transmitting and Receiving Antenna

ILHR 62.35 Scope. The requirements of this part shall apply to the outdoor portion of all apparatus, more than 12 feet in height, used for transmitting and receiving television or radio waves.

History: Cr. Register, December, 1978, No. 276, eff. 1-1-79.

ILHR 62.36 Construction requirements. All television and radio antenna systems, including the supporting tower or mast, shall be constructed of galvanized steel or other corrosive-resistant noncombustible material. Where approved by the department, towers constructed of wood or wood poles set in the ground may be used to support antenna

Register, August, 1985, No. 356

systems, but no wood tower or wood pole may be mounted on the roof of any building structure.

History: Cr. Register, December, 1978, No. 276, eff. 1-1-79.

ILHR 62.37 Design loads. (1) **DEAD AND ICE LOADS.** The supporting tower shall be designed for the dead load of the structure and all appurtenances plus an ice load of at least ½ inch in radial thickness. The ice load shall be considered on all members of the structure including guys.

(2) **WIND LOADS.** (a) Self-supporting towers shall be designed for the wind loads specified in s. ILHR 53.12.

1. Open face or latticed tower structures shall be designed for wind pressure applied to the projected area of all members, including ice, in one face multiplied by the following factors:

- a. 1.75 for towers of square cross-section; or
- b. 1.5 for towers of triangular cross-section.

2. Wind loads shall be considered basic design loads with no increase in allowable unit stresses permitted.

(b) Guyed towers shall be designed in accordance with a recognized engineering standard.

Note: "Structural Standards for Steel Antenna Towers and Antenna Supporting Structures", EIA Standard RS-222-C, published by Electronic Industries Association, 2001 Eye Street, N.W., Washington, D.C. 20006, is an acceptable standard for the design of guyed towers and self-supporting towers.

History: Cr. Register, December, 1978, No. 276, eff. 1-1-79; r. and recr. Register, December, 1983, No. 336, eff. 1-1-84.

ILHR 62.38 Antenna systems on buildings. Antenna systems installed on the roof of a building shall not be supported by or attached to a chimney. All such installations shall be mounted on an independent platform or base and anchored in place. The platform or base of the tower shall be sized to distribute the weight of the structure so the roof construction will safely support the weight of the structure in addition to the required live and dead roof loads.

History: Cr. Register, December, 1978, No. 276, eff. 1-1-79.

ILHR 62.39 Setbacks. No wires, cables, or guy wires shall extend over any street or other public thoroughfare or over any electric power or communication lines.

History: Cr. Register, December, 1978, No. 276, eff. 1-1-79; am. Register, December, 1983, No. 336, eff. 1-1-84.

ILHR 62.40 Antenna system support. Poles used for electric power or for communication lines shall not be used for supporting or for guying any antenna system. Where antenna installations are so located that damage will be caused to adjacent power or communication lines by the falling of the antenna structure, a separate safety wire shall be attached to the top of the tower and secured in a direction away from the power or communication lines.

History: Cr. Register, December, 1978, No. 276, eff. 1-1-79.

ILHR 62.41 Electrical requirements. Electrical installations in connection with antenna systems, including the grounding of the tower or mast,

shall comply in all respects with the requirements of the Wisconsin state electrical code, volume 2, ch. ILHR 16.

History: Cr. Register, December, 1978, No. 276, eff. 1-1-79.

Subchapter III—Tents

ILHR 62.42 Scope. The requirements of this part shall apply to all tents, except those used exclusively for construction purposes.

History: Cr. Register, January, 1980, No. 289, eff. 2-1-80.

ILHR 62.43 Area limitation and setbacks. (1) **AREA OF GROUND COVERED.** No tent shall be erected to cover more than 75% of the premises on which it is located.

(2) **SETBACK TO PROPERTY LINE AND OTHER STRUCTURES.** (a) Tents used for assembly purposes which cover 1500 square feet or more of ground area shall be located at least 20 feet from any other structure or adjoining property lines.

(b) Concession and other tents not used for assembly purposes need not be separated from each other and may be located less than 20 feet from other structures.

(3) **SETBACK FOR EXITING.** Stake lines of adjacent tents used for assembly purposes shall be sufficient distance from each other to provide an emergency exit passageway not less than 6 feet in width between stake lines. Proper protection shall be provided along such stake lines to eliminate tripping hazards.

History: Cr. Register, January, 1980, No. 289, eff. 2-1-80.

ILHR 62.44 Structural requirements. (1) **MATERIAL SIZE AND STRENGTH.** Poles and other members supporting tents shall be of sufficient size and strength to support the structure safely without exceeding the stresses specified in ch. ILHR 53 of this code.

(2) **WIND LOAD.** (a) All tents shall be adequately guyed, supported and braced to withstand a wind pressure or suction of not less than 10 pounds per square foot.

(b) The poles, guys, stakes, fastenings and similar devices shall be of sufficient strength and so attached as to resist a wind pressure of at least 20 pounds per square foot of projected area of the tent.

History: Cr. Register, January, 1980, No. 289, eff. 2-1-80.

ILHR 62.45 Flame resistance. All tents used for assembly purposes or in which animals are stabled and all other tents used by the public in places of outdoor assembly shall be effectively flameproofed. The owner shall furnish a certificate or a test report by a recognized testing engineer or laboratory as evidence that such tents have the required flame resistance.

History: Cr. Register, January, 1980, No. 289, eff. 2-1-80.

FP ILHR 62.46 Fire hazards. (1) **CLEARING OF GROUND.** The ground enclosed by an tent used in connection with a place of outdoor assembly and for a distance of not less than 10 feet outside such structure on all sides shall be cleared of all flammable material or vegetation which will
Register, August, 1985, No. 356

transmit fire. The premises shall be kept free from such flammable material during the period the premises are used by the public.

(2) **COMBUSTIBLE MATERIAL FOR CARE OF ANIMALS.** No hay, straw, shavings or similar combustible materials other than that necessary for the current feeding and care of animals shall be permitted within any tents used for public assembly except that sawdust and shavings may be used if kept damp.

(3) **NO SMOKING.** No smoking or unapproved open flame of any kind shall be permitted in any tent while occupied by the public. "No Smoking" signs shall be conspicuously posted in all tents open to the public.

(4) **SAFETY FILM.** Tents shall not be used for motion picture performances unless safety film is used.

History: Cr. Register, January, 1980, No. 289, eff. 2-1-80.

ILHR 62.47 Exits. (1) **NUMBER OF EXITS.** (a) Every tent occupied by the public shall have at least 2 standard exits located at or near opposite ends of the structure. **FP**

(b) In tents used for assembly purposes, exits shall be provided on 3 sides if the capacity exceeds 600 persons and on 4 sides where the capacity exceeds 1,000 persons.

(2) **EXIT DISTANCE.** Exits shall be uniformly distributed but in no case shall the line of travel to an exit be greater than 150 feet.

(3) **EXIT WIDTH.** The total width of exits from a tent used for assembly purposes shall be not less than 44 inches per 100 persons. Exit openings shall comply in all respects with the requirements of ss. ILHR 51.15 and 55.10 of this code.

History: Cr. Register, January, 1980, No. 289, eff. 2-1-80.

ILHR 62.48 Toilet facilities. Separate toilet facilities, in conjunction with all tents used as places of outdoor assembly, shall be provided in accordance with s. ILHR 55.32. Toilet rooms and equipment shall comply with the requirements of ss. ILHR 52.50-52.64 of this code or as approved by the department.

History: Cr. Register, January, 1980, No. 289, eff. 2-1-80.

ILHR 62.49 Electrical installations. (1) **GENERAL.** Electrical systems in all tents used as places of outdoor assembly shall be installed in accordance with the requirements of the Wisconsin state electrical code, volume 2, ch. ILHR 16. All such systems shall be maintained and operated in a safe and workmanlike manner. **FP**

(2) **PROTECTION AND ISOLATION.** The electrical system and equipment shall be isolated from the public by proper elevation and guarding. All electrical fuses and switches shall be installed in approved enclosures. Cables laid on the ground or in areas traversed by the public shall be placed in trenches or protected by approved covers.

History: Cr. Register, January, 1980, No. 289, eff. 2-1-80.

ILHR 62.50 *Fire extinguishers. (1) **GENERAL.** Portable fire extinguishers shall be installed as specified in Table 62.50. **FP**

*See Appendix A for further explanatory material.

TABLE 62.50

Basic Minimum Extinguisher Rating	Maximum Travel Distance to Extinguisher (feet)	Area to be Protected per Extinguisher (sq. ft.)
1A	75	3,000
2A	75	6,000
3A	75	9,000
4A or larger	75	11,250

(2) **LOCATION.** (a) Extinguishers shall be conspicuously located where they will be readily accessible and immediately available in the event of fire.

(b) Extinguishers shall not be obstructed or obscured from view.

(3) **MAINTENANCE.** Portable fire extinguishers shall be maintained as specified in s. ILHR 51.22.

History: Cr. Register, January, 1980, No. 289, eff. 2-1-80; r. and recr., Register, December, 1981, No. 312, eff. 1-1-82.

FP ILHR 62.51 Illumination; exit lights and signs. (1) **LIGHTING OF EXITS.** All exits, aisles and passageways leading to exits in tents used as places of outdoor assembly shall be kept adequately lighted at all times when the structure is occupied by the public. Artificial illumination having an intensity of not less than 2.5 footcandles at the floor line shall be provided when natural light is inadequate.

(2) **ILLUMINATED EXIT SIGNS.** Exit lights and signs complying with the requirements of s. ILHR 55.11 shall be provided in all tents used as places of outdoor assembly where more than 100 persons can be accommodated.

History: Cr. Register, January, 1980, No. 289, eff. 2-1-80.

Subchapter IV—Outdoor Theaters

ILHR 62.52 Scope. The requirements of this part shall apply to all outdoor theaters now in existence and to outdoor theaters hereafter constructed, except as provided in s. ILHR 62.56.

History: Cr. Register, January, 1980, No. 289, eff. 2-1-80.; correction made under s. 13.93 (2m) (b) 7, Stats., Register, August, 1985, No. 356.

ILHR 62.53 Entrances and exits. All entrances and exits for outdoor theaters shall comply with the regulations of the department of transportation for driveways from property abutting state highways and the following additional requirements:

(1) **NUMBER OF ENTRANCES.** Not more than one entrance shall be provided for each access road but each such entrance may be divided into 2 roadways and channelized to properly provide for vehicles turning right or left from the highway.

(2) **HIGHWAY RIGHT-OF-WAY.** That portion of an entrance or exit lying within the highway right-of-way shall comply with the regulations of the authority in charge of the maintenance of the highway or, in the event this authority has no regulation, it shall comply with regulations prescribed by the state department of transportation.

Register, August, 1985, No. 356

(3) **NUMBER OF EXITS.** Not more than one exit shall be provided for each access highway but such exit may be suitably channelized to provide for right and left turns to the highway, and not more than one traffic lane shall be permitted for each traffic lane on the highway available to vehicles leaving the theater.

History: Cr. Register, January, 1980, No. 289, eff. 2-1-80.

ILHR 62.54 Vehicle storage. (1) **AREA NEEDED.** A storage area for vehicles, equal to not less than 10% of the theater capacity, shall be provided between the highway and the ticket booth. In all cases, sufficient storage space shall be provided so the vehicles will not back up on the traveled way of the highway. Storage area shall be calculated on the basis of 162 square feet per vehicle.

(2) **HOLD-OVER AREA.** A hold-over storage area having sufficient capacity to accommodate not less than 15% of the theater capacity shall be provided between the ticket booth and the ramp area.

History: Cr. Register, January, 1980, No. 289, eff. 2-1-80.

ILHR 62.55 Tower construction. The tower supporting the motion picture screen shall be designed to resist a horizontal wind pressure of not less than 30 pounds for every square foot of exposed surface.

History: Cr. Register, January, 1980, No. 289, eff. 2-1-80.

ILHR 62.56 Location of tower. The screen shall be so oriented that the picture is not visible from any major highway. This requirement does not apply to towers erected prior to January 1, 1952.

History: Cr. Register, January, 1980, No. 289, eff. 2-1-80.

ILHR 62.57 Concession and motion picture machine booth. (1) **MOTION PICTURE BOOTH.** The motion picture booth and equipment shall comply in all respects with the requirements of ss. ILHR 55.40 through 55.49.

(2) **CONCESSION BUILDINGS.** Concession buildings in connection with outdoor theaters shall comply with the requirements of ch. ILHR 54.

History: Cr. Register, January, 1980, No. 289, eff. 2-1-80.

ILHR 62.58 Sanitary equipment. (1) **NUMBER OF FIXTURES REQUIRED.** Outdoor theaters shall be provided with separate toilet facilities as required by s. ILHR 55.32. Toilet rooms and equipment shall comply with the requirements of ss. ILHR 52.50 through 52.64.

(2) **DETERMINATION OF CAPACITY.** In determining the number of fixtures required for toilet rooms in connection with outdoor theaters, the capacity of the theater is established by allowing 2¼ persons for each vehicle accommodated, exclusive of vehicles parked in the waiting or hold-over area.

(3) **APPROACHES TO TOILET ROOMS.** Where the public toilet rooms are so located that the patrons must cross the ramp area in order to reach the toilet rooms, a suitable approach or passageway leading thereto shall be maintained. Such passageways shall be properly lighted and they shall be kept free from obstructions.

History: Cr. Register, January, 1980, No. 289, eff. 2-1-80.

ILHR 62.59 Ramps and speaker equipment. (1) **RAMP SPACING.** Ramps shall be spaced not less than 38 feet apart. The ramps shall be so designed

that any vehicle can move from its parked position to the exit driveway without being required to back up.

(2) **SURFACE REQUIRED.** All ramps, parking areas, entrance and exit driveways shall be properly surfaced with a gravel surfacing or better, adequate to withstand the weight of the vehicles accommodated.

(3) **PUBLIC TRANSPORTATION SPEAKER FACILITIES.** Where additional seating space is provided in the theater enclosure for patrons using public transportation facilities, the speaker arrangement shall be such that the sound will be confined to the immediate seating area and not broadcast beyond the theater enclosure.

(4) **SPACING OF SPEAKER POSTS AND ELECTRICAL WIRING.** There shall not be less than 18 feet distance between speaker posts, measured parallel to the ramps, except in seated areas for patrons using public transportation. All electrical wiring and electrical equipment shall be installed in accordance with the provisions of the Wisconsin state electrical code, volume 2, ch. ILHR 16. Each speaker post shall be wired with wire approved for underground use laid in trenches not less than 12 inches in depth.

History: Cr. Register, January, 1980, No. 289, eff. 2-1-80.

ILHR 62.60 Lighting. All entrance and exit driveways shall be adequately lighted and properly marked to avoid congestion and confusion and shall remain lighted throughout the performance and until the audience has left the area.

History: Cr. Register, January, 1980, No. 289, eff. 2-1-80.

ILHR 62.61 Speed limit. In every outdoor theater, notices of a permanent character shall be prominently displayed designating the maximum speed limit permitted for cars driven within the area. Parking lights shall be used when cars moving in the theater enclosure.

History: Cr. Register, January, 1980, No. 289, eff. 2-1-80.

ILHR 62.62 Running of engines. At each performance, an instructive trailer shall be shown on the screen informing the patrons of the danger of carbon monoxide poisoning when the engine is running and stating that when it becomes necessary to run the engine, the windows of the vehicle should be opened at least one inch.

History: Cr. Register, January, 1980, No. 289, eff. 2-1-80.

Subchapter V Assembly Seating Facilities

ILHR 62.70 Scope. The requirements of this subchapter apply to all assembly seating facilities intended primarily to support persons for the purpose of spectator seating.

History: Cr. Register, December, 1981, No. 312, eff. 1-1-82.

ILHR 62.71 Approval and supervision. (1) **APPROVAL OF PLANS.** Plans and specifications shall be submitted to the department in accordance with the applicable provisions of ch. ILHR 50. The following information shall also be included with each submittal:

(a) A plot plan for outdoor seating facilities showing location of facility relative to property lines and adjacent buildings or structures on the same premises; or a floor plan for indoor seating facilities showing location of seating relative to all required exits, aisles and passageways;

(b) Location and size of all structural members, seating area and number of seats, aisles and guardrail assemblies and number and spacing of all rows; and

(c) Structural calculations or a test report made by an independent testing agency and certified by a Wisconsin registered architect or engineer showing that the dead and live load in the open or partially open position and dead load in the closed position can be safely carried by the supporting structure.

1. Exception. The information specified in this paragraph need not be submitted if the seating facility has been granted a materials approval as specified in sub. (2).

(2) APPROVAL OF DESIGN. The design of each type or model of a seating facility may be approved by the department prior to installation for designs that are structurally repetitive in nature.

Note: See s. ILHR 50.19 for further information.

(3) INSTALLATION SUPERVISION. (a) The installation of all permanent seating facilities having more than 5 rows in height shall be erected under the supervision of a Wisconsin registered architect or engineer.

(b) Every temporary seating facility shall be inspected for proper erection in accordance with the manufacturer's instructions prior to initial public occupancy.

History: Cr. Register, December, 1981, No. 312, eff. 1-1-82.

ILHR 62.72 Inspection and maintenance. Every seating facility shall be inspected at least annually. Any loose connections, defective or broken members shall be repaired before the facility is used. All repairs and maintenance shall conform with the provisions of chs. ILHR 50-64. **FP**

History: Cr. Register, December, 1981, No. 312, eff. 1-1-82.

ILHR 62.73 Design loads. (1) **DEAD LOADS.** All seating facilities shall be designed and constructed to support the actual dead weight of all component members.

(2) **LIVE LOADS.** All seating facilities shall be designed and constructed to support the superimposed minimum live loads specified in Table 62.73. In every case where the live load is greater than the minimum, the actual load shall be used. The most severe distribution, concentration and combination of design loads and forces shall be taken into consideration.

TABLE 62.73
MINIMUM STRUCTURAL LOADINGS

Component or Load Orientation	Load *
Vertical loads:	
Seating structure with load applied over the horizontal projected area	100 PSF
Seats and footboards	120 PLF
Seating platforms	100 PSF
Nonseating areas, such as aisles and passageways	100 PSF
Sway loads in combination with vertical loads:	
Acting parallel to seating	24 PLF
Acting normal to seating, such as front to rear and rear to front	10 PLF
Wind loads in combination with live, dead and sway loads:	
Vertical projected area when occupied	15 PSF
Vertical projected area when unoccupied	30 PSF
Guardrail loads:	
All rail members with load acting vertically and horizontally	50 PLF
Floor and ground loadings:	
Floors supporting seating facilities	See Table 53-I
Ground supporting seating facilities	See ch. ILHR 53-Part II

* PSF = Pounds per square foot; PLF = Pounds per linear foot

(3) **PARTIAL LOADING.** (a) Except as provided in par. (b), structural members in which the stresses are greater under a partial loading than under full loading shall be designed to meet the conditions of greatest stress.

(b) Allowable stresses due to dead and live loads combined with either the wind or sway load or both, may be increased 33¼% provided the structural capacity of the component used is not less than that required for dead and live loads alone.

(4) **ANCHORAGE LOADS.** Folding or telescoping seating facilities that are attached to a floor or wall shall be anchored to withstand all impact loads in addition to the required live and dead loads.

(5) **STRUCTURAL MEMBER OMISSION.** All seating facilities shall be designed and manufactured so that if any structural member essential to the strength and stability of the structure is omitted during erection, the absence of such unused member will be self-evident.

(6) **FOUNDATIONS, BASE PLATES AND MUDSILLS.** (a) Where provided, foundations for seating facilities shall comply with the requirements of ch. ILHR 53, Part II.

(b) Mudsills of approved material sized to prevent settlement shall be provided when seating facilities rest directly on the ground. All bearing surfaces between mudsills and base plates shall be in full contact with each other.

History: Cr. Register, December, 1981, No. 312, eff. 1-1-82.

ILHR 62.74 Construction requirements. (1) **AREA LIMITATIONS.** (a) *Combustible construction.* Seating facilities constructed entirely of combustible construction shall not exceed 10,000 square feet in ground area or 200 feet in length.

Register, August, 1985, No. 356

(b) *Partially noncombustible construction.* Seating facilities shall not exceed 20,000 square feet in ground area or 400 feet in length when constructed of any of the following:

1. Noncombustible framing and combustible seatboards or footboards;
2. Entirely of fire retardant treated wood; or
3. Entirely of members conforming to dimensions for heavy timber construction as specified in s. ILHR 51.03 (4).

(c) *Noncombustible construction.* Seating facilities constructed of totally noncombustible construction shall not be limited in ground area or length.

(2) **HEIGHT LIMITATION.** (a) *Combustible construction.* Seating facilities constructed entirely of combustible materials shall not exceed 20 feet above the ground or floor.

(b) *Noncombustible construction.* Seating facilities constructed of totally or partially noncombustible construction shall not be limited in height.

(c) *Within tents.* The highest level of seat platforms of any portable seating facility within a tent shall not exceed 12 feet above the ground or floor.

(d) *Folding or telescoping.* The highest level of seat platforms of any folding or telescoping seating facility not attached to a wall shall not exceed 12 rows or 11 feet above the floor, whichever is lower.

(3) **CLEARANCE LIMITATIONS.** A minimum of 7 feet vertical clearance shall be provided between any platform, seatboard or footboard and any ceiling or projection beneath the ceiling.

(4) **LOCATION AND SETBACK.** Outdoor seating facilities shall be located at least 10 feet from any other building or adjoining property line unless the exterior walls of such adjacent building are of one-hour fire-resistive construction or better and all openings therein are protected with fire-resistive doors and windows as specified in ss. ILHR 51.047 and 51.048.

(5) **BARRIER-FREE REQUIREMENTS.** Accessible seating space shall be provided in permanent, elevated seating facilities in accordance with the applicable requirements as specified in s. ILHR 52.04.

History: Cr. Register, December, 1981, No. 312, eff. 1-1-82.

ILHR 62.75 Means of egress. (1) **TYPE OF EXITS.** (a) Except as provided in par. (b), all required exits from any part of a seating facility shall be doorways, stairways or ramps conforming to the requirements specified in ss. ILHR 55.08 through 55.10. FP

(b) Doorways, stairways and ramps are not required for assembly seating facilities when aisles are not required.

(2) **NUMBER OF EXITS.** (a) *Outdoor seating.* Every outdoor seating facility, and every balcony or tier considered separately, shall be provided with at least 2 exits located as remote from each other as practicable and leading directly to the outside at grade. If the capacity of any such facility, balcony or tier exceeds 1,000 persons, there shall be at least 3 exits

and where the capacity exceeds 4,000 persons, there shall be at least 4 exits.

(b) *Indoor seating.* The number of exits for every indoor seating facility shall comply with the requirements as specified in s. ILHR 55.07.

(3) **DISTANCE TO EXITS.** Exits shall be distributed uniformly to prevent congestion and shall be so located that the line of travel to an exit or to a street, alley or open court is not greater than 150 feet.

(4) **AGGREGATE WIDTH OF EXITS.** (a) *Outdoor seating.* The total clear width of exits from any outdoor seating facility shall be not less than 22 inches for each 500 persons, or fraction thereof.

(b) *Indoor seating.* The total clear width of exits off of any indoor seating facility shall be not less than 22 inches per 100 persons, or fraction thereof.

(5) **EXIT LIGHTS AND SIGNS.** Exit lights and signs shall comply with the requirements as specified in s. ILHR 55.11.

(6) **AISLES REQUIRED.** (a) Except as provided in par. (b), aisles shall be required in all seating facilities.

(b) Aisles may be omitted provided all of the following conditions exist:

1. Seats are without backrests;
2. The rise between rows does not exceed 12 inches;
3. The number of rows does not exceed 20 for outdoor seating facilities or 16 for indoor seating facilities;
4. The row spacing does not exceed 28 inches; and
5. The first seatboard is not more than 20 inches above the ground or floor.

(7) **AISLE WIDTH.** Aisles having seats on both sides shall be not less than 42 inches in width and aisles having seats on one side only shall be not less than 36 inches wide.

(8) **AISLE LOCATION.** (a) *Outdoor seating.* For seating not within a building, the number of seats between any seat and an aisle shall not be greater than 20 when the seats are without backrests and 11 when the seats have backrests.

(b) *Indoor seating.* Except as provided in par. (c), the number of seats between any seat and an aisle for seating within a building, shall not be greater than 9 when the seats are without backrests and 6 when the seats have backrests.

(c) *Continental seating.* The number of seats between any seat and an aisle may be increased to 49 where:

1. A minimum unobstructed passage of 22 inches is provided between rows of unoccupied seats; and
2. The unobstructed passage between rows leads to a side aisle on each end of the rows where exit doors are located at no more than 20 foot intervals leading to an exit corridor or exit court.

(9) **CROSS AISLES.** Where provided, aisles parallel to the seat rows shall be not less than 48 inches in width.

(10) **UNOBSTRUCTED MEANS OF EGRESS.** No aisle, stair, door or other way of ingress or egress shall be obstructed in any manner while the seating facility is occupied by the public.

History: Cr. Register, December, 1981, No. 312, eff. 1-1-82.

ILHR 62.76 Seating. (1) **SEATING ARRANGEMENTS.** A minimum 12-inch spacing shall be provided between the back of each seat and the front of the seat immediately behind it. The seating arrangement shall comply with the spacing requirements specified in Table 62.76. Where the same level is used for both seats and footrests, the width of this level shall be not less than 26 inches.

TABLE 62.76
 ROW SPACING REQUIREMENTS

Type of Seating	Minimum Back-to-Back Spacing ¹ (Inches)
Seats without backrests	22
Seats with backrests	30
Chair seating	32

¹All measurements are taken between plumb lines.

(2) **FOOTRESTS.** Where the same level is not used for both seatboard and footboard, independent footrests shall be provided.

(3) **SEATBOARDS AND FOOTBOARDS.** (a) Seatboards and footboards (footrests) shall have a minimum width of 9 inches.

(b) All seatboards and footboards shall be fastened in place in such a manner that they cannot be accidentally displaced.

(4) **SEAT OCCUPANT WIDTH.** The seating capacity shall be established by allowing one sitting or seat to each 18 inches of length.

(5) **RISE BETWEEN ROWS.** The maximum rise between seat rows shall not exceed 16 inches unless the horizontal row spacing is 40 inches or more.

(6) **STEPS.** Where the rise between rows exceeds 12 inches, intermediate steps shall be provided the full width of the aisles. Such steps shall have a uniform rise of not more than 8 inches and a tread of not less than 10 inches in width. In no case shall the angle of seating exceed 45 degrees.

(7) **OPENINGS.** The design of the seatboards and footboards shall be such that a sphere with a diameter larger than 9 inches will not pass from the seating area to the area beneath the seating where seatboards are more than 5 rows above the ground or floor.

History: Cr. Register, December, 1981, No. 312, eff. 1-1-82.

ILHR 62.77 Guardrails. (1) **FRONT RAIL.** Where the front footrest or cross aisle is more than 2 feet above the ground or floor, a guardrail with a midrail shall be provided at the front of such footrest or cross aisle.

(a) *At front footrest.* When required, the rail at the front footrest shall be not less than 30 inches in height.

(b) *At front cross aisle.* When required, the rail at the front cross aisle shall be not less than 36 inches in height.

(2) **BACK AND SIDE RAILS.** (a) Except as provided in par. (b), a guardrail not less than 42 inches in height above the aisle surface or footrest or above the center of the seatboard surface, whichever is adjacent, shall be provided along the back and sides of seating where the seats are more than 4½ feet above the ground or floor.

(b) When a wall or fence is within 6 inches of seating and affords protection equivalent to that required under par (a), guardrails may be omitted.

(3) **OPENINGS BELOW TOP RAIL.** All back, side and front cross aisle guardrails shall have intermediate rails or an ornamental pattern between the footboard or cross aisle and the top rail to prevent the passage of a sphere with a diameter larger than 9 inches.

(4) **CROSS AISLE RAIL.** A guardrail not less than 30 inches in height with a midrail shall be provided along the front edge of cross aisles where the backs of the seats in front of the cross aisle are less than 24 inches above the cross aisle surface.

(5) **LOADING.** All guardrails shall be designed and constructed to withstand a vertical and horizontal load of 50 pounds per linear foot. Loads need not be applied simultaneously.

History: Cr. Register, December, 1981, No. 312, eff. 1-1-82.

FP ILHR 62.78 Isolation of hazards. (1) **GENERAL.** (a) Except as provided in par. (b), all fuel-fired heating boilers and furnaces, power boilers, fuel rooms and breeching, storage vaults for paints, oils, and similar combustibles and other similar hazards in a seating facility shall be isolated from the rest of the seating facility by at least 2-hour fire-resistive construction as specified in ss. ILHR 51.04 to 51.049.

(b) Direct vent sealed combustion chamber appliances and suspended heating equipment as specified in Table 64.21 need not be enclosed with fire-resistive rated construction as specified in par. (a).

Note: See ch. Ind 8, for isolation of flammable and combustible liquids.

(2) **PROTECTION OF OPENINGS.** All openings shall be protected with self-closing fire-resistive doors as specified in s. ILHR 51.047.

History: Cr. Register, December, 1981, No. 312, eff. 1-1-82; r. and recr., Register, August, 1985, No. 356, eff. 1-1-86.

ILHR 62.79 Sanitary facilities. All places of spectator assembly shall be provided with toilet rooms and sanitary fixtures as specified in s. ILHR 55.32. Toilet room construction and equipment shall comply with the requirements as specified in ss. ILHR 52.50 to 52.64.

History: Cr. Register, December, 1981, No. 312, eff. 1-1-82.
Register, August, 1985, No. 356

(9) **CROSS AISLES.** Where provided, aisles parallel to the seat rows shall be not less than 48 inches in width.

(10) **UNOBSTRUCTED MEANS OF EGRESS.** No aisle, stair, door or other way of ingress or egress shall be obstructed in any manner while the seating facility is occupied by the public.

History: Cr. Register, December, 1981, No. 312, eff. 1-1-82.

ILHR 62.76 Seating. (1) **SEATING ARRANGEMENTS.** A minimum 12-inch spacing shall be provided between the back of each seat and the front of the seat immediately behind it. The seating arrangement shall comply with the spacing requirements specified in Table 62.76. Where the same level is used for both seats and footrests, the width of this level shall be not less than 26 inches.

TABLE 62.76
 ROW SPACING REQUIREMENTS

Type of Seating	Minimum Back-to-Back Spacing ¹ (Inches)
Seats without backrests	22
Seats with backrests	30
Chair seating	32

¹All measurements are taken between plumb lines.

(2) **FOOTRESTS.** Where the same level is not used for both seatboard and footboard, independent footrests shall be provided.

(3) **SEATBOARDS AND FOOTBOARDS.** (a) Seatboards and footboards (footrests) shall have a minimum width of 9 inches.

(b) All seatboards and footboards shall be fastened in place in such a manner that they cannot be accidentally displaced.

(4) **SEAT OCCUPANT WIDTH.** The seating capacity shall be established by allowing one sitting or seat to each 18 inches of length.

(5) **RISE BETWEEN ROWS.** The maximum rise between seat rows shall not exceed 16 inches unless the horizontal row spacing is 40 inches or more.

(6) **STEPS.** Where the rise between rows exceeds 12 inches, intermediate steps shall be provided the full width of the aisles. Such steps shall have a uniform rise of not more than 8 inches and a tread of not less than 10 inches in width. In no case shall the angle of seating exceed 45 degrees.

(7) **OPENINGS.** The design of the seatboards and footboards shall be such that a sphere with a diameter larger than 9 inches will not pass from the seating area to the area beneath the seating where seatboards are more than 5 rows above the ground or floor.

History: Cr. Register, December, 1981, No. 312, eff. 1-1-82.

ILHR 62.77 Guardrails. (1) **FRONT RAIL.** Where the front footrest or cross aisle is more than 2 feet above the ground or floor, a guardrail with a midrail shall be provided at the front of such footrest or cross aisle.

(a) *At front footrest.* When required, the rail at the front footrest shall be not less than 30 inches in height.

(b) *At front cross aisle.* When required, the rail at the front cross aisle shall be not less than 36 inches in height.

(2) **BACK AND SIDE RAILS.** (a) Except as provided in par. (b), a guardrail not less than 42 inches in height above the aisle surface or footrest or above the center of the seatboard surface, whichever is adjacent, shall be provided along the back and sides of seating where the seats are more than 4½ feet above the ground or floor.

(b) When a wall or fence is within 6 inches of seating and affords protection equivalent to that required under par (a), guardrails may be omitted.

(3) **OPENINGS BELOW TOP RAIL.** All back, side and front cross aisle guardrails shall have intermediate rails or an ornamental pattern between the footboard or cross aisle and the top rail to prevent the passage of a sphere with a diameter larger than 9 inches.

(4) **CROSS AISLE RAIL.** A guardrail not less than 30 inches in height with a midrail shall be provided along the front edge of cross aisles where the backs of the seats in front of the cross aisle are less than 24 inches above the cross aisle surface.

(5) **LOADING.** All guardrails shall be designed and constructed to withstand a vertical and horizontal load of 50 pounds per linear foot. Loads need not be applied simultaneously.

History: Cr. Register, December, 1981, No. 312, eff. 1-1-82.

FP ILHR 62.78 Isolation of hazards. (1) **GENERAL.** (a) Except as provided in par. (b), all fuel-fired heating boilers and furnaces, power boilers, fuel rooms and breeching, storage vaults for paints, oils, and similar combustibles and other similar hazards in a seating facility shall be isolated from the rest of the seating facility by at least 2-hour fire-resistive construction as specified in ss. ILHR 51.04 to 51.049.

(b) Direct vent sealed combustion chamber appliances and suspended heating equipment as specified in Table 64.21 need not be enclosed with fire-resistive rated construction as specified in par. (a).

Note: See ch. Ind 8, for isolation of flammable and combustible liquids.

(2) **PROTECTION OF OPENINGS.** All openings shall be protected with self-closing fire-resistive doors as specified in s. ILHR 51.047.

History: Cr. Register, December, 1981, No. 312, eff. 1-1-82; r. and recr., Register, August, 1985, No. 356, eff. 1-1-86.

ILHR 62.79 Sanitary facilities. All places of spectator assembly shall be provided with toilet rooms and sanitary fixtures as specified in s. ILHR 55.32. Toilet room construction and equipment shall comply with the requirements as specified in ss. ILHR 52.50 to 52.64.

History: Cr. Register, December, 1981, No. 312, eff. 1-1-82.
Register, August, 1985, No. 356

to any permanent loads such as, but not limited to, hanging baskets, planters and similar items, that are to be supported by structural mem-

bers for a continuous period of 30 days or more, and the loads shall be included as part of the dead load.

(2) **CONCENTRATED LOADS.** (a) All roof members, such as but not limited to, purlins, rafters and truss top members, shall be capable of safely supporting a minimum concentrated live load of 100 pounds applied downward and normal to the roof surface at their midspan. In addition, each bottom chord panel point of the roof trusses shall be capable of safely supporting a minimum concentrated live load of 100 pounds.

(b) Maximum allowable deflection for structural members of greenhouses may not exceed 1/120 of span.

(3) **ROOF LOADS.** (a) *Definitions.* The following definitions apply only to the provisions of this section:

1. "Thermal resistance (R)" means a factor which measures the resistance of a material to the transmission of heat.

Note: The smaller the R value, the greater the amount of heat a material will transmit.

2. "Continuously heated single glazed greenhouse" means a single glazed greenhouse which has a constantly maintained interior temperature of at least 50° F., measured at 3 feet above the floor surface, a maintenance attendant is on duty at all times or the greenhouse is equipped with a temperature alarm system to provide warning in the event of a heating system failure and the roof material has a total thermal resistance of less than 1.0.

Note: Air inflated double film greenhouse roof materials and air inflated double film over rigid light-transmitting material satisfy the intent of this definition.

3. "Continuously heated double glazed greenhouse" means a double glazed greenhouse which meets the requirements specified in subd. 2. except that the roof material may have a total thermal resistance of greater than 1.0, but less than 2.0.

4. "Intermittently heated or unheated greenhouse" means any greenhouse that does not meet the requirements specified in subd. 2. or 3.

(b) *Roof loads.* 1. Except as specified in subd. 3., roof structural members subject to snow accumulation shall be designed for the following roof load distributions:

THERMAL CONDITION	MINIMUM ROOF LOAD
Continuously heated single glazed greenhouse	15 Pounds Per Square Foot
Continuously heated double glazed greenhouse	20 Pounds Per Square Foot
Intermittently heated or unheated greenhouse	See s. ILHR 53.11 (4) (a)

2. The minimum roof loads shall be distributed over the entire area shall be applied to the horizontal projection of the roof.

3. Free-standing, single glazed, Quonset-type greenhouses not over 4,500 square feet gross ground area shall be designed for a minimum roof load of 10 pounds per square foot.

(c) *Heat transfer barriers.* Heat transfer barriers installed in the interior of the greenhouse may be used in winter months if they are automatically or manually retractable with a 20 minute time period. Permanent heat transfer barriers may not be used.

(d) *Wind loads.* Except as provided in subds. 1. and 2., greenhouses shall be designed to withstand the wind loads specified in s. ILHR 53.12.

1. Greenhouses with a maximum height of 30 feet shall be designed to resist a minimum of total wind load of 15 pounds per square foot.

2. Quonset-type greenhouses not over 15 feet in height shall be designed to resist a minimum total wind load of 10 pounds per square foot.

History: Cr. Register, December, 1983, No. 336, eff. 1-1-84.

Subchapter VII

Pedestrian Access Structures Connecting Buildings

ILHR 62.97 Scope. The requirements of this subchapter shall apply to all structures used as pedestrian access corridors or walkways between buildings or structures.

History: Cr. Register, August, 1985, No. 356, eff. 1-1-86.

FP ILHR 62.98 General requirements. (1) **CONSTRUCTION.** All pedestrian access structures shall be of one of the following classes of construction as specified in s. ILHR 51.03:

(a) Structures of 4 stories or less, where the open space below elevated structures is counted as a story, shall be of Type 6 construction, or better, and shall be of totally noncombustible construction;

(b) 1. Except as provided in subd. 2., structures of 5 stories, where the space below elevated structures is counted as a story, shall be of Type 3 construction, or better.

2. Supporting columns in the space beneath elevated structures may be of noncombustible 0-hour rated construction.

(c) 1. Except as provided in subd. 2., structures of 6 or more stories, where the space below elevated structures is counted as a story, shall be of Type 2 construction, or better.

2. Supporting columns in the space beneath elevated structures may be of noncombustible 0-hour rated construction.

(2) **FLOORS.** (a) Except as provided in par. (b), floor systems separating pedestrian walkway levels shall be of noncombustible one-hour rated construction or better.

(b) The floor system between the lowest pedestrian level and the space below an elevated structure may be of noncombustible 0-hour rated construction.

Register, August, 1985, No. 356

(3) **SEPARATIONS.** The pedestrian access structure shall be separated from any building to which it is connected as follows:

(a) 1. Except as provided in subd. 2., the wall of the building within the structure separating the structure from the building shall be of at least 2-hour rated construction.

2. The wall separating the structure from the building need not be of hourly-rated construction provided the structure is more than 20 feet long and all side walls of the structure be open to the atmosphere with the area of the opening being equal to or exceeding 30% of the side wall area.

(b) 1. Except as provided in subd. 2., openings in the wall separating the structure from the building shall be protected with 1½-hour rated fire door assemblies equipped with self-closing devices activated by products of combustion detectors which respond to products of combustion other than heat.

2. a. The opening may be protected with an open head water deluge curtain activated by a products of combustion detector which responds to products of combustion other than heat, in conjunction with solid doors equipped with self-closing devices activated by the water deluge curtain detector.

b. The protection of openings in the wall separating the structure from the building may be omitted provided the structure is more than 20 feet long and all side walls of the structure be open to the atmosphere with the area of the opening being equal to or exceeding 30% of the side wall area.

(4) **EXTERIOR PROTECTION.** (a) Where the sidewalls of a pedestrian access structure are within 10 feet horizontally of a wall opening of the connected or an adjacent building, the wall opening shall be protected by at least a ¾-hour rated fire door or fire window assembly or the sidewalls of the structure shall be of at least noncombustible 1-hour rated construction for a distance or at least 10 feet from the opening or the wall of the connected building.

(b) 1. Except as provided in subd. 2., all wall openings of a connected building directly below or below and within 10 feet horizontally of the pedestrian access structure shall be protected by at least ¾-hour rated fire door or fire window assemblies or the lower floor of the structure shall be of at least noncombustible one-hour rated construction for a distance of at least 20 feet from the wall of the connected building.

2. The fire resistive rated construction and protection of openings specified in subd. 1. may be omitted provided the pedestrian access structure is protected by a complete automatic fire sprinkler system.

(5) **SEPARATION AT LOT LINE.** (a) Pedestrian access structures constructed over lot lines and connecting buildings with different owners shall be provided with a separation having a minimum 2-hour fire-resistive rating.

(b) All openings in the separation shall be protected by approved 1½-hour rated fire door assemblies or better.

(6) FIRE DEPARTMENT ACCESS. (a) Except as provided in par. (b), fire department access openings as specified in s. ILHR 52.02 (2) shall be provided on each level of the pedestrian access structure.

(b) Fire department access openings may be omitted in structures protected by a complete automatic fire sprinkler system.

History: Cr. Register, August, 1985, No. 356, eff. 1-1-86.

FP ILHR 62.99 Exiting. (1) NUMBER OF EXITS. (a) Except as provided in sub. (3), every pedestrian access structure, and every level, other than the open space below the structure, shall be provided with at least one exit.

(2) TYPE OF EXITS. (a) Except as provided in par. (b), the exit specified in sub. (1) from the pedestrian access structure shall be an exit door to grade, a stairway to grade constructed as specified in s. ILHR 51.16, or a fire escape to grade constructed as specified in s. ILHR 51.20.

(b) 1. Open stairways or fire escapes may not be used as an exit for any level more than 55 feet above grade.

2. Type "A" fire escapes may terminate on a platform at least 3 feet long, located not more than 10 feet above grade.

(3) EXCEPTIONS. The exit specified in sub. (1) from the pedestrian access structure may be omitted providing:

(a) The doors connecting the structure and the building are equipped with exit hardware such that a person can pass from the structure into the building; or

(b) The doors connecting the structure and the building are equipped with hardware that requires a key to pass from the building onto the structure, and that key will also open the door allowing passage from the structure back into the building.

(4) EXIT DISTANCE. (a) Except as provided in par. (b), exits shall be distributed or located so that no part of the pedestrian access structure will be more than 200 feet distance from an exit.

(b) Where approved automatic fire sprinklers are provided throughout the pedestrian access structure, an increase in exit distance to 300 feet will be permitted.

History: Cr. Register, August, 1985, No. 356, eff. 1-1-86.

ILHR 62.991 Special requirements. (1) PERMITTED USE. Pedestrian access structures may not be used for purposes other than pedestrian walkways.

(2) HEATING AND VENTILATING. (a) Pedestrian access structures need not be heated but shall be provided with ventilation as specified in s. ILHR 64.05 for shopping mall corridor areas.

(b) If the pedestrian access structure is to be heated, the structure shall comply with the provisions of ch. ILHR 63 based upon the inside design temperature utilized.

Register, August, 1985, No. 356

(3) **STRUCTURAL.** (a) The floor of the pedestrian access structure shall be designed and constructed for the actual loading, but in no case shall the design live load be less than 100 pounds per square foot.

(b) The roof of the pedestrian access structure shall be designed and constructed in accordance with the provisions of s. ILHR 53.11 (4).

(c) The pedestrian access structure shall be designed and constructed to withstand the wind loads specified in s. ILHR 53.12.

(d) Elevated pedestrian access structures shall be designed as bridges, including design factors for sway, sympathetic vibration and deflection.

History: Cr. Register, August, 1985, No. 356, eff. 1-1-86.

Chapter ILHR 63

ENERGY CONSERVATION

Part I Scope and Purpose	Part V Water Heating
ILHR 63.001 Scope (p. 337)	ILHR 63.30 Purpose (p. 348)
ILHR 63.002 Purpose (p. 338)	ILHR 63.31 Water heaters, storage tanks and boilers (p. 348)
ILHR 63.01 Plans and specifications (p. 338)	ILHR 63.32 Conservation of hot water (p. 348)
Part II Definitions	ILHR 63.33 Insulation (p. 349)
ILHR 63.02 Definitions (p. 338)	Part VI Illumination and Electrical Systems
Part III Design Conditions	ILHR 63.41 Lighting (p. 349)
ILHR 63.10 Scope (p. 339)	ILHR 63.42 Lighting control (p. 351)
ILHR 63.11 General requirements (p. 339)	Part VII Non-Depletable Energy Source
ILHR 63.12 Design criteria (p. 341)	ILHR 63.50 Buildings utilizing solar, geothermal, wind or other nondepletable energy source (p. 352)
Part IV Heating and Air Conditioning Equipment and System	ILHR 63.51 Documentation (p. 352)
ILHR 63.20 Equipment efficiencies (p. 343)	Part VIII System Analysis Design
ILHR 63.21 Controls (p. 345)	ILHR 63.60 Annual energy consumption (p. 352)
ILHR 63.22 Insulation (p. 347)	ILHR 63.61 Simulation (p. 352)
ILHR 63.23 Cooling with outdoor air in conjunction with mechanical cooling systems (economizer cycle) (p. 348)	ILHR 63.62 Documentation (p. 353)
ILHR 63.24 Maintenance (p. 348)	

Note: Chapter Ind 63 was renumbered to be chapter ILHR 63 effective January 1, 1984.

Part I—Scope and Purpose

ILHR 63.001 Scope. (1) **GENERAL.** The provisions of this chapter shall apply to all public buildings and places of employment. These provisions are not retroactive unless specifically stated in the administrative rule. Where different sections of this chapter specify different requirements, the most restrictive requirement shall govern.

(2) **EXEMPT BUILDINGS AND STRUCTURES.** Buildings and structures, or portions thereof, without space heating or cooling, service water heating, or illumination are exempt from the requirements of this chapter.

(3) **APPLICATIONS TO EXISTING BUILDINGS.** (a) Additions to existing buildings or structures may be made without making the entire building or structure comply, but the addition shall comply with the requirements of this chapter.

(b) Any change of occupancy or use of any existing building or structure within the scope of this chapter which would increase the energy consumption shall not be permitted unless such building or structure is made to comply with the requirements of this chapter.

(c) Heating and cooling equipment replacement and complete lighting system replacement shall comply with the requirements of this chapter.

Note: It is the intent of the department to have every new building or addition and every change of occupancy meet the energy conservation requirements of this chapter. It is not the intent to prevent a previously built building from installing air conditioning, nor to cause equipment with several years of remaining service to be discarded due to not being able to meet the required efficiencies of this chapter. However, occupancy changes such as building a

warehouse and later remodeling it into an office space will not be permitted unless all the requirements of this chapter are met.

History: Cr. Register, May, 1978, No. 269, eff. 7-1-78, am. (2) and (3)(b), Register, January, 1980, No. 289, eff. 2-1-80; cr. (3) (c), Register, December, 1983, No. 336, eff. 1-1-84.

ILHR 63.002 Purpose. The purpose of this chapter is to provide design requirements which will promote efficient utilization of energy in public buildings and places of employment.

(1) **GENERAL.** The intent of this chapter is to provide minimum requirements for construction and equipment to conserve energy.

(2) **FLEXIBILITY IN USE.** It is intended that this chapter be flexible and permit the use of innovative approaches and techniques to achieve effective utilization of energy.

(3) **CONFLICT WITH OTHER RULES.** This chapter is not intended to conflict with any safety or health requirements. Where such conflict occurs, the safety and health requirements shall govern.

History: Cr. Register, May, 1978, No. 269, eff. 7-1-78.

ILHR 63.01 Plans and specifications. Architectural and mechanical plans and specifications shall be submitted in accordance with the requirements outlined in ss. ILHR 50.07 and 50.12 and shall contain details and data to demonstrate compliance with the requirements of this chapter. Such information shall include, but is not limited to: design criteria, exterior envelope component materials, resistance values of insulating materials, and the thermal performance value of the building envelope. Size and type of equipment, system and equipment controls and equipment efficiencies shall be submitted with the mechanical plans.

Note: The resistance values for insulating materials are expressed in Fahrenheit degrees per Btu/(hour)(square foot).

History: Cr. Register, May, 1978, No. 269, eff. 7-1-78; am. (1), Register, December, 1978, No. 276, eff. 1-1-79; r. and rec. (2), Register, January, 1980, No. 289, eff. 2-1-80; r. (2), renum. (1) to be ILHR 63.01, Register, December, 1985, No. 360, eff. 1-1-86.

Part II—Definitions

ILHR 63.02 Definitions. (1) **COEFFICIENT OF PERFORMANCE (COP).** Coefficient of performance is the ratio of the rate of net heat removal for cooling or net heat output for heating to the rate of total energy input, expressed in consistent units and under standard rating conditions.

(2) **COOLING LOAD.** Cooling load is the rate at which heat must be removed from the space to maintain a selected indoor air temperature.

(3) **ENERGY.** Energy is the capacity for doing work; taking a number of forms which may be transformed from one into another, such as thermal (heat), mechanical (work), electrical, and chemical; in customary units, measured in kilowatt hours (kwh) or British thermal units (Btu).

(4) **ENERGY EFFICIENCY RATIO (EER).** The energy efficiency ratio is the ratio of net cooling capacity in Btu per hour to total rate of electric input in watts under designated operating conditions.

(5) **NONDEPLETABLE ENERGY SOURCES.** Nondepletable energy sources are sources of energy (excluding minerals) derived from incoming solar radiation, including photosynthetic processes; from phenomena resulting therefrom, including wind, waves and tides, lake or pond thermal differences; and energy derived from the internal heat of the earth, including nocturnal thermal exchanges.

(6) **RECOVERED ENERGY.** Recovered energy is the energy utilized which would otherwise be wasted from an energy utilization system.

(7) **SERVICE WATER HEATING.** Service water heating is the supply of hot water for domestic or commercial purposes other than comfort heating and processing.

(8) **THERMAL PERFORMANCE.** Thermal performance is the design heat loss, excluding infiltration and ventilation, through above-grade gross walls and roofs facing heated interiors.

(9) **ZONE.** A zone is a space or group of spaces within a building with heating or cooling requirements sufficiently similar so that comfort conditions can be maintained throughout by a single controlling device. As a minimum, each floor of a building shall be considered as a separate zone.

History: Cr. Register, May, 1978, No. 269, eff. 7-1-78; am. (2), Register, January, 1980, No. 289, eff. 2-1-80.

Part III—Design Conditions

ILHR 63.10 Scope. The criteria of this part establish the minimum requirements for the thermal design of the exterior envelope of buildings and establish criteria for the design of the heating, ventilating and air-conditioning systems and their parts.

History: Cr. Register, May, 1978, No. 269, eff. 7-1-78.

ILHR 63.11 General requirements. (1) **BUILDING USE.** When a building houses more than one use, each portion of the building shall conform to the requirements for the use housed therein.

(2) **MOISTURE CONDENSATION.** The design of buildings for energy conservation shall not create conditions of accelerated deterioration from moisture condensation.

Note: The designer should consider the use of vapor barriers and ventilation to control condensation.

(3) **INFILTRATION.** *Exterior openings.* The following openings, and all other similar openings in the exterior building envelopes, shall be caulked, gasketed, weatherstripped, or otherwise sealed:

1. Exterior joints around window and door frames;
2. Between wall cavities and window or door frames;
3. Between walls and floors;
4. Between separate wall panels; and
5. At penetrations of utility services through walls, floors and roofs.

(b) *All Exterior windows and doors.* All exterior windows and doors shall be designed to limit air leakage into or from the building and shall be caulked, gasketed, weatherstripped or otherwise sealed.

(c) *Factory manufactured exterior windows and doors.* Factory manufactured exterior windows and doors shall be designed and manufactured to have a rate of infiltration equal to or less than the rates specified in Table 63.11.

TABLE 63.11

AIR INFILTRATION RATES FOR FACTORY MANUFACTURED
EXTERIOR WINDOWS AND DOORS

Component	Infiltration Rate (Expressed in CFM/linear foot of perimeter crack of operable sash, unless otherwise specified)
Operable windows, prime	
Residential*	.30
All other occupancies	.15
Prehung, swing-type doors	.50
Glazed, sliding (patio type) doors	.50
	CFM/square foot of door area

*Residential occupancies include all ch. ILHR 57 residential occupancies including motels and hotels.

1. Compliance with the air infiltration rates specified in Table 63.11 shall be certified by an independent testing laboratory or a Wisconsin registered architect or professional engineer using the criteria for air leakage specified in ASTM E-283, Standard Method of Test for Rate of Air Leakage Through Exterior Windows, Curtain Walls and Doors at a pressure differential of 1.567 pounds per square foot (equivalent to effect of 25 mile per hour wind).

Note: The term "factory manufactured" does not apply to units constructed or fabricated in the field or to units assembled from individual components at a lumber yard or building material center.

(4) **DESIGN TEMPERATURE DIFFERENTIALS.** (a) *Winter.* The winter design temperature differential shall be determined using the indoor design temperature as given in Table 1 of ch. ILHR 64 and the outdoor design temperature as given in Figure 1.

(b) *Summer.* The summer design temperature differential shall be determined using an indoor design temperature of 78° F. and the outdoor design temperature as given in Figure 1.

FIGURE 1

OUTDOOR DESIGN CONDITIONS

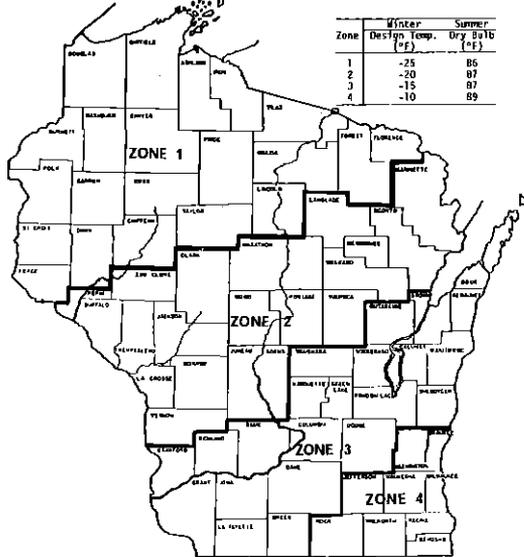

(5) PROHIBITION OF HEATED SIDEWALKS. The installation or use of heated sidewalks is prohibited as specified in s. 101.124, Stats.

Note: Section 101.124, Stats., reads as follows:

"Heated Sidewalks Prohibited. In this section "exterior pedestrian traffic surface" means any sidewalk, ramp, stair, stoop, step, entrance way, plaza or pedestrian bridge not fully enclosed within a building and "heated" means heated by electricity or energy derived from the combustion of fossil fuels, but not including the use of waste thermal energy. "Exterior pedestrian traffic surface" does not include any means of ingress and egress by the physically disabled required under s. 101.13 (2), Stats. No person may construct a heated exterior pedestrian traffic surface. The department may not approve any plan under s. 101.12, Stats., which includes such heated surface. The department shall order any existing heated exterior pedestrian traffic surface in operation after April 30, 1980, to be shut off. This section does not apply to any inpatient health care facility as defined in s. 140.85 (1), Stats."

History: Cr. Register, May, 1978, No. 269, eff. 7-1-78; r. and rec. (3), Register, May, 1980, No. 293, 6-1-80; am. (3) and (4), cr. (5), Register, December, 1981, No. 312, eff. 1-1-82; am. table and (3) (c) 1., Register, August, 1985, No. 356, eff. 1-1-86.

ILHR 63.12 Design criteria. (1) THERMAL PERFORMANCE. (a) Except as provided in par. (b), the thermal performance values for the exterior envelope of all buildings, shall not exceed the values specified in Table 63.12-A.

TABLE 63.12-A

THERMAL PERFORMANCE VALUES

Number of Stories	Thermal Performance Values*
1-2	12
3-4	13
5-7	16
8-12	18
13-20	20
Over 20	21

*Expressed in Btu/hour/square foot of above-grade exterior envelope.

(b) 1. The thermal performance values for the exterior envelope of all ch. ILHR 57 residential buildings of 3 stories or less in height shall not exceed 9 Btu/hour/square foot of above-grade exterior envelope.

2. The thermal performance values specified in Table 63.12-A shall not apply to special use buildings, such as greenhouses, tents, inflatable and similar types of structures.

3. The thermal performance values specified in par. (a) may be increased or decreased provided the U value for other components is decreased or increased so the total heat gain or loss for the entire building envelope and floor area does not exceed the total heat gain or loss resulting from conformance to the values specified in subs. (1) through (3).

Note: To determine the thermal performance value of a building, the designer may use a static or dynamic method of calculation provided such calculation method is acceptable to the department.

(2) FLOORS OVER UNCONDITIONED SPACES. The overall heat transmission coefficient (U-value) for floors of heated or mechanically cooled spaces over unconditioned spaces shall not exceed 0.08 Btu/°F. Sq. Ft. hour.

(3) SLAB-ON-GRADE PERIMETER INSULATION. For slab-on-grade floors with or without grade beam, foundation bearing wall or foundation frost wall, the thermal resistance of the insulation around the perimeter of the floor shall not be less than the values shown in Table 63.12-B. The insulation shall extend 48 inches in the vertical or horizontal direction or combination thereof with a total dimension of 48 inches. Slab-on-grade perimeter insulation shall be moisture resistant.

TABLE 63.12-B

PERIMETER INSULATION REQUIREMENTS

Slab-on-grade Perimeter Insulation		Zone 1	Zone 2	Zone 3	Zone 4
R = $\frac{^{\circ}\text{F Sq. Ft. Hour}}{\text{Btu}}$	Unheated Slabs	6.7	6.2	5.9	5.2
	Heated Slabs†	9.3	9.0	8.6	8.2

† Heated slabs have piping, ductwork or other heat distribution system components embedded in or under them.

History: Cr. Register, May, 1978, No. 269, eff. 7-1-78; am. (1)(intro.), Register, January, 1980, No. 289, eff. 2-1-80; r. and recr. (1), Register, May, 1980, No. 293, eff. 6-1-80; am., Register, December, 1981, No. 312, eff. 1-1-82; am. (1) (b) 1., Register, October, 1982, No. 322, eff. 11-1-82; r. and recr. (3), Register, December, 1983, No. 336, eff. 1-1-84; am. (1) (b) 1., Register, August, 1985, No. 356, eff. 1-1-86.

Register, August, 1985, No. 356

Part IV—Heating and Air-Conditioning Equipment and Systems

ILHR 63.20 Equipment efficiencies. (1) **ELECTRICAL EQUIPMENT.** All electrical heating and cooling equipment shall comply with the minimum coefficients of performance (COP) or energy efficiency ratios (EER) established in this section.

(a) *Air-conditioning equipment.* Air-conditioning equipment shall have minimum EER and COP values as indicated in Table 63.20-A.

(b) *Heat pumps.* Heat pumps in the cooling mode shall have EER and COP values as indicated in Table 63.20-A based on the standard rating conditions specified in Table 63.20-B. Heat pumps in the heating mode shall be rated at the standard rating conditions and have a minimum COP as shown in Table 63.20-C.

TABLE 63.20-A
 MINIMUM EER AND COP FOR ELECTRIC HEATING, VENTILATING AND
 AIR-CONDITIONING SYSTEM EQUIPMENT, COOLING MODE†

Standard Rating Capacity	EER	COP
Under 65,000 Btu/hour (19,050 watts)	7.8	2.3
65,000 Btu/hour (19,050 watts) and over	8.2	2.4

†Adopted from Table 6.2, ASHRAE Standard 90A-80, Energy Conservation in New Building Design (The American Society of Heating, Refrigerating, and Air-Conditioning Engineers, Inc., 1791 Tullie Circle N.E., Atlanta, Georgia 30329).

TABLE 63.20-B
 HVAC SYSTEM EQUIPMENT STANDARD RATING
 CONDITIONS†—COOLING††

Item		Temperatures			
		Dry Bulb	Wet Bulb	Inlet	Outlet
Air Entering Equipment	°F(°C)	80(26.7)	67(19.4)	—	—
Condenser Ambient (Air Cooled)	°F(°C)	95(35.0)	75(23.9)	—	—
Condenser Water (Water Cooled)	°F(°C)	—	—	85(29.4)	95(35.0)

†Standard ratings are at sea level.

††Reproduced with permission from ASHRAE Standard 90A-80, Energy Conservation in New Building Design (The American Society of Heating, Refrigerating, and Air-Conditioning Engineers, Inc., 1791 Tullie Circle, N.E., Atlanta, Georgia 30329).

TABLE 63.20-C

MINIMUM COP FOR HEAT PUMPS, HEATING MODE†

Source and Outdoor Temperature °F	Minimum COP
Air Source (return air 70° F) 47 db/43 wb	2.7
Air Source (return air 70° F) 17 db/15 wb	1.8
Water Source 60° Entering (return air 70°F)	3.0

†Adapted from Tables 6.10 ASHRAE Standard 90A-80, Energy Conservation in New Building Design (The American Society of Heating, Refrigerating, and Air-Conditioning Engineers, Inc., 1791 Tullie Circle, N.E., Atlanta, Georgia 30329).

TABLE 63.20-D

MINIMUM COP FOR HEATING, VENTILATING AND AIR-CONDITIONING SYSTEMS, HEAT-OPERATED COOLING EQUIPMENT†

Heat Source	Minimum COP
Direct-fired (gas, oil)	0.48
Indirect-fired (steam, hot water)	0.68

†Adapted from Table 6.7 ASHRAE Standard 90A-80, Energy Conservation in New Building Design (The American Society of Heating, Refrigerating, and Air-Conditioning Engineers, Inc., 1791 Tullie Circle, N.E., Atlanta, Georgia 30329).

(2) **COMBUSTION HEATING EQUIPMENT.** All gas-fired and oil-fired heating equipment shall have a minimum combustion efficiency of 75% at maximum rated output.

(3) **HEAT-OPERATED EQUIPMENT, COOLING MODE.** Heat-operated cooling equipment shall have a COP cooling not less than the values shown in Table 63.20-D when tested at standard rating conditions. These requirements apply to, but are not limited to, absorption equipment, engine-driven equipment and turbine-driven equipment.

(4) **ELECTRICALLY OPERATED SYSTEMS COMPONENTS, COOLING MODE.** Components of heating, ventilating and air-conditioning systems having entirely electric energy input shall have a COP cooling not less than the values shown in Table 63.20-E when tested at the standard conditions shown in Table 63.20-F.

TABLE 63.20-E

MINIMUM COP FOR ELECTRICALLY DRIVEN HEATING, VENTILATING
AND AIR-CONDITIONING SYSTEM COMPONENTS†

Component	Condensing Means	Air		Water		Evaporative	
		EER	COP	EER	COP	EER	COP
Self-Contained Water Chillers	Centrifugal	8.0	2.3	13.8	4.0	—	—
	Positive Displacement	8.4	2.5	12.0	3.5	—	—
Condenserless Water Chillers	Positive Displacement	9.9	2.9	12.0	3.5	—	—
Compressor and Condenser Units 65,000 Btu/hour (19,050 watts and over)	Positive Displacement	9.5	2.8	12.5	3.7	12.5	3.7

†Adapted from Tables 6.4 and 6.5 ASHRAE Standard 90A-80, Energy Conservation in New Building Design (The American Society of Heating, Refrigerating and Air-Conditioning Engineers, Inc., 1791 Tullie Circle, N.E., Atlanta, Georgia 30329).

TABLE 63.20-F

APPLIED HVAC SYSTEM COMPONENTS
STANDARD RATING CONDITIONS†—COOLING††

Item		Centrifugal or Self-Contained Reciprocating Water Chiller	Condenserless Reciprocating Water Chiller
Leaving Chilled Water Temp	*F	44	44
Entering Chilled Water Temp	*F	54	54
Leaving Condenser Water Temp	*F	95	—
Entering Condenser Water Temp	*F	85	—
Fouling Factor, Water			
Nonferrous Tubes	*	0.0005	0.0005
Steel Tubes	*	0.0010	0.0010
Fouling Factor, Refrigerant	*	0.0000	0.0000
Condenser Ambient (Air or Evap. Cooled)	*F	95 db/75 wb	—
Compressor Saturated			
Water Cooled (or Evap. Cooled)	*F	—	105
Discharge Temp			
Air Cooled	*F	—	120

†Standard ratings are at sea level.

*F Sq. Ft. Hour
Btu

††Adapted from Table 6.3.1, ASHRAE Standard 90A-80, Energy Conservation in New Building Design (The American Society of Heating, Refrigerating, and Air-Conditioning Engineers, Inc., 1791 Tullie Circle, N.E., Atlanta, Georgia 30329).

History: Cr. Register, May, 1978, No. 269, eff. 7-1-78; am. tables A, C, D and E, Register, January, 1980, No. 289, eff. 2-1-80; reprinted to correct error in (1) (b), Register, June, 1983, No. 330; r. and recr. tables A, C and E, am. tables B, D, and F, Register, December, 1983, No. 336, eff. 1-1-84.

ILHR 63.21 Controls. (1) ZONE HEATING AND COOLING. Simultaneous heating and cooling by reheating or recooling supply air or by concurrent

operation of independent heating and cooling systems serving a common zone shall be in accordance with the following:

(a) *Reheat systems*: Single zone reheat systems shall be controlled to sequence reheat and cooling. Multiple reheat systems serving multiple zones, other than those employing variable air volume for temperature control, shall be provided with controls that will automatically reset the system cold air supply to the highest temperature level that will satisfy the zone requiring the coolest air.

(b) *Dual duct and multi-zone systems*. These systems shall be provided with control(s) that will automatically reset:

1. The cold deck air supply to the highest temperature that will satisfy the zone requiring the coolest air; and

2. The hot deck air supply to the lowest temperature that will satisfy the zone requiring the warmest air.

(c) *Recooling systems*: Systems in which heated air is recooled, directly or indirectly, to maintain space temperature shall be provided with controls that will automatically reset the temperature to which the supply air is heated to the lowest level that will satisfy the zone requiring the warmest air.

1. *Exception*. A multiple zone heating, ventilating and air-conditioning system that employs reheating or recooling for control of not more than 5,000 cfm or 20% of the total supply air of the system, whichever is less, shall be exempt from the supply air temperature reset requirements of pars. (a), (b) and (c).

(d) *Heat pump supplemental heater*. The heat pump shall be installed with a control to prevent simultaneous operation of a supplemental heater when the heating load can be met by the heat pump alone. A two-stage thermostat, which controls the supplementary heat on its second stage, will be accepted as meeting this requirement. The cut-on temperature for the compression heating shall be higher than the cut-on temperature for the supplementary heat, and the cut-off temperature for the compression heating shall be higher than the cut-off temperature for the supplementary heat.

Note: Supplemental heater operation is permitted during transient periods, such as startups, following room thermostat set point advance, and during defrost.

(2) **CONCURRENT OPERATION**. Concurrent operation of independent heating and cooling systems serving common spaces and requiring the use of new energy for heating or cooling shall be minimized by one or both of the following:

(a) Providing sequential temperature control of both heating and cooling capacity in each zone;

(b) Limiting the heating energy input through automatic reset control of the heating medium temperature (or energy input rate) to only that necessary to offset heat loss due to transmission and infiltration and, where applicable, to heat the ventilation air supply to the space.

History: Cr. Register, May, 1978, No. 269, eff. 7-1-78; r. (1)(intro.) and am. (1)(d), Register, January, 1980, No. 289, eff. 2-1-80; r. (8), Register, December, 1981, No. 312, eff. 1-1-82. Register, August, 1985, No. 356

ILHR 63.22 Insulation. (1) **AIR-HANDLING DUCT INSULATION.** All ducts, plenums and similar enclosures serving buildings shall be insulated as follows:

(a) All duct systems, or portions thereof, shall be insulated to provide a thermal resistance, excluding film resistances, of:

$$R = \frac{\Delta T}{15} \quad \text{°F Sq. Ft. Hour/Btu}$$

Where ΔT equals the design temperature differential in degrees F between the air in the duct, plenum or similar enclosure and the surrounding medium. For underground duct insulation, the surrounding medium (ground) temperature for ducts within the building perimeter shall be 40° F. and for ducts outside the building perimeter shall be 30° F.

(b) *Exceptions.* Duct insulation is not required:

1. Where ΔT is 25° F or less;

2. When the heat gain or loss of the ducts, plenums and similar enclosures, without insulation, will not increase the energy consumption of the building.

(2) **PIPE INSULATION.** All piping within buildings shall be thermally insulated to achieve at least the equivalent insulation values of Table 63.22. Minimum insulation thickness shall be increased for materials with thermal resistance less than 4.0 °F Sq. Ft. Hour/Btu/inch or may be reduced for materials with thermal resistance greater than 4.6 °F Sq. Ft. Hour/Btu/inch.

Note: See s. ILHR 63.33 (2) for service water piping insulation.

(a) *Exception.* Piping insulation shall not be required where the fluid temperature is between 55°F and 120°F.

TABLE 63.22

MINIMUM PIPE INSULATION

(The thicknesses specified in this table are based on insulation having thermal resistance in the range of 4.0 H-Ft²- F²/Btu to 4.6 H-Ft²-F²/Btu per inch of thickness on a flat surface at a mean temperature of 75°F)

Piping System Types	Fluid Temperature Range °F	Insulation Thickness in Inches for Pipe Sizes†					
		Run-Outs†† up to 2"	1" and less	1½" to 2"	2½" to 4"	5" to 6"	8" and larger
Heating Systems:							
Steam and Hot Water							
High Pressure/Temp	306-450	1½	2½	2½	3	3½	3½
Med. Pressure/Temp	251-305	1½	2	2½	2½	3	3
Low Pressure/Temp	201-250	1	1½	1½	2	2	2
Low Temperature	120-200	½	1	1	1½	1½	1½
Steam Condensate (for feed water)	Any	1	1	1½	2	2	2
Cooling Systems:							
Chilled Water	40-55	¾	¾	1	1	1½	1½
Refrigerant	Below 40	1	1	1½	1½	1½	1½

† For piping exposed to outdoor ambient temperatures, increase thickness by ½ inch.

†† Run-outs not exceeding 12 feet in length to individual terminal units.

Note: Also see s. ILHR 64.37 for additional requirements.

History: Cr. Register, May, 1978, No. 269, eff. 7-1-78; am. Register, January, 1980, No. 289, eff. 2-1-80; am. (1) (a), Register, December, 1981, No. 312, eff. 1-1-82; r. and recr. table, Register, December, 1983, No. 336, eff. 1-1-84.

ILHR 63.23 Cooling with outdoor air in conjunction with mechanical cooling systems (economizer cycle) (1) OUTDOOR AIR. Each fan system shall be designed to use up to and including 100% of the fan system capacity for cooling with outdoor air automatically whenever its use will result in lower usage of new energy. Activation of economizer cycle shall be controlled by sensing outdoor air enthalpy and dry bulb temperature jointly, or outdoor air dry bulb temperature alone.

(a) *Exception.* Cooling with outdoor air is not required when the cooling capacity of the fan system is less than 60,000 Btu per hour.

Note: It is the intent of this section to require cooling with outdoor air for nominal 5-ton units or larger.

History: Cr. Register, May, 1978, No. 269, eff. 7-1-78; am. (1)(a), Register, January, 1980, No. 289, eff. 2-1-80.

ILHR 63.24 Maintenance. Equipment shall be labeled to clearly state the required regular maintenance. Such label may be limited to identifying, by title or publication number, the operation and maintenance manual for that particular model and type of product. Maintenance instructions shall be furnished for any equipment which requires preventive maintenance for efficient operation.

History: Cr. Register, May, 1978, No. 269, eff. 7-1-78.

Part V—Water Heating

ILHR 63.30 Purpose. The purpose of this part is to provide energy conservation criteria for the design and equipment selection for service water heating.

History: Cr. Register, May, 1978, No. 269, eff. 7-1-78.

ILHR 63.31 Water heaters, storage tanks and boilers. (1) COMBINATION SERVICE WATER HEATING/SPACE HEATING BOILERS. Space heating boilers shall not be used for service water heating from May 1 to September 30 unless the service water heating load equals or exceeds 30% of the net boiler load.

(2) **TEMPERATURE CONTROLS.** Service water heating systems shall be equipped with automatic temperature controls capable of adjustment from the lowest to the highest acceptable temperature settings for the intended use.

Note: The department recognizes the values specified in Table 1, ASHRAE Handbook and Product Directory, Systems Volume, Chapter 37.

(3) **SHUT DOWN.** A separate means shall be provided to permit turning off the energy supplied to service water heating systems.

History: Cr. Register, May, 1978, No. 269, eff. 7-1-78.

ILHR 63.32 Conservation of hot water. (1) SHOWERS. Showers shall be equipped to limit the flow of water to not more than 3 gallons per minute per shower head.

Register, August, 1985, No. 356

(2) **LAVATORIES.** Lavatories (washbasins) in toilet rooms of nonresidential public buildings shall be equipped to limit the flow of water through the faucet, after the handle is released, to not more than one gallon. Lavatories in toilet rooms of private living units shall be equipped to limit the flow to not more than 3 gallons per minute.

(3) **HEATED SWIMMING POOLS.** Heated swimming pools shall comply with the following:

(a) Heated swimming pools shall be equipped with controls to limit heating water temperatures to no more than 80° F, except for pools used for therapeutic purposes.

(b) Unenclosed heated pools shall be controlled so that the electric resistance or fossil-fueled pool water heating systems are inoperative from September 15 to May 15.

Note: The requirements of (3) of this section will be enforced by the department of health and social services. The same rules will be included in Wis. Adm. Code chapter H 72—Users of Indoor or Outdoor Artificial Swimming Pools.

History: Cr. Register, May, 1978, No. 269, eff. 7-1-78; am. (1) and (2), Register, January, 1980, No. 289, eff. 2-1-80.

ILHR 63.33 Insulation. (1) **STORAGE TANKS.** Heat loss from unfired hot water storage tanks shall be limited to 15 Btu per hour per square foot of external tank surface area. The design ambient temperature shall be no higher than 65° F.

(2) **PIPING.** (a) Except as provided in par. (b), piping heat loss for recirculation systems shall be limited to a maximum of 25 Btu per hour per square foot of external pipe insulation surface for aboveground piping and a maximum of 35 Btu per hour per square foot of external pipe insulation surface for underground piping. Maximum heat loss shall be determined at a ΔT equal to the maximum water temperature minus a design ambient temperature no higher than 65° F.

(b) Conformance to the minimum pipe insulation requirements specified in Table 63.22 shall be deemed as complying with the requirements of this subsection.

History: Cr. Register, May, 1978, No. 269, eff. 7-1-78; cr. (2) (a), Register, May, 1980, No. 293, eff. 6-1-80; am. (2), Register, December, 1983, No. 336, eff. 1-1-84.

Part VI—Illumination and Electrical Systems

ILHR 63.40 Power factor. **History:** Cr. Register, May, 1978, No. 269, 7-1-78; am. (1), Register, January, 1980, No. 289, eff. 2-1-80; r. and recr., Register, December, 1981, No. 312, eff. 1-1-82; r. Register, August, 1985, No. 356, eff. 1-1-86.

ILHR 63.41 Lighting. The building lighting shall be designed in accordance with one of the following methods:

(1) **LIGHTING POWER BUDGET.** (a) Except as provided in par. (b), for purposes of establishing a budget, the power allowed for the lighting load shall not exceed the value for the space use as indicated in Table 63.41. Each area of space shall be multiplied by its maximum lighting load respective value as indicated in Table 63.41. This calculation shall be made for all areas of the building and these values shall be summed to yield a total allowable lighting wattage. This total allowable lighting wattage is the maximum amount of lighting power for the building, which may then be allocated as desired provided this value is not exceeded.

(b) The following areas or classes of lighting equipment are exempt from the criteria of par. (a):

1. Local task lighting fixtures applied to an individual location with switching under the user's immediate control, such as, but not limited to, a portable desk lamp, a work light on a machine, or a hospital examination light; or

2. Lighting for special applications where the lighting is an essential technical element for the function performed, such as theatrical performances.

(2) ILLUMINATION BUDGET. If the total allowable lighting wattage value determined by the calculations outlined in sub. (1) is exceeded, then the illumination shall be determined by a method acceptable to the department.

Note #1: The material in this section is not intended to be used as a lighting design procedure. The purpose of this section is solely to outline a procedure for determining the maximum power limit for the lighting.

Note #2: See s. PSC 113.315, Wis. Adm. Code, for individual electric metering requirements for nontransient multi-dwelling unit residential buildings.

TABLE 63.41

LIGHTING POWER VALUES

Area/Use	Maximum Connected Lighting Load (Watts/Sq. Ft.)
<u>General</u>	
Conference Room	2.0
Corridor	1.0
Employee Cafeteria	2.0
Janitor Closet	0.5
Lobby	1.0
Locker Room	2.0
Lunch Room	2.0
Mechanical Room	0.5
Parking, Indoor	0.25
Parking, Outdoor	0.05
Office	3.0
Perimeter Facade	5.0/linear ft.
Reception or Waiting Room	3.0
Shower Room	2.0
Stairway	1.0
Storage	0.5
Toilet	2.0
<u>Assembly (Chs. ILHR 54 and ILHR 55)</u>	
Auditorium	2.0
Church Nave and Sanctuary	2.0
Dining Area	2.0
Gymnasium	2.0
Kitchen, Commercial	2.5
Natorium	2.0
Racquet Court	2.0
Recreation Area	2.0
Tavern	2.0
Theatre	2.0
<u>Educational (Chs. ILHR 56 and ILHR 60)</u>	
Auditorium	2.0
Classroom	2.5

TABLE 63.41 continued

Area/Use	Maximum Connected Lighting Load (Watts/Sq. Ft.)
Day Care/Nursery	2.5
Gymnasium	2.0
Laboratory	2.5
Library, Reading Area	3.0
Library, Stack Area.....	0.5
Museum	2.5
Natorium	2.0
Vocational Shop	2.5
<u>Health Care (Ch. ILHR 58)</u>	
Examination Room	3.0
Laboratory	2.5
Nurse Station	3.0
Operating Room.....	3.0
Patient Room.....	1.0
Physical Therapy	2.0
Treatment Room.....	3.0
<u>Industrial (Ch. ILHR 54)</u>	
Assembly.....	2.5
Inspection	2.5
Laboratory	2.5
Manufacturing	2.5
Shipping and Receiving.....	2.5
Storage (Including Warehouse Storage).....	0.5
<u>Mercantile (chs. ILHR 54 and ILHR 59)</u>	
Garage, Repair	1.0
Kitchen, Commercial	2.5
Laundry, Commercial.....	2.5
Mall	2.0
Sales Area (Including Display Lighting).....	2.5
Stock Room.....	1.0
<u>Residential (Ch. ILHR 57)</u>	
Bathroom	2.0
Closet	0.5
Hotel or Motel Bedroom	1.0
Kitchen, Residential.....	2.5
Laundry Area.....	2.5
Living or Sleeping Area	1.0
Storage.....	0.5

Notes:

1. Use the most similar area/use designation for unlisted occupancies.
2. In general, canopy lighting is given the value assigned for similar indoor tasks. For example, a shopping center canopy is given the 2.0 watts/sq. ft. value of mall.

History: Cr. Register, May, 1978, No. 269, eff. 7-1-78; am. (1) and (2), Register, December, 1981, No. 312, eff. 1-1-82. .

ILHR 63.42 Lighting control. Each room enclosed by ceiling-height partitions shall have independent control of the lighting in that room through control devices located within the room.

History: Cr. Register, May, 1978, No. 269, eff. 7-1-78; r. and recr., Register, December, 1981, No. 312, eff. 1-1-82.

Part VII—Nondepletable Energy Source

ILHR 63.50 Buildings utilizing solar, geothermal, wind or other nondepletable energy source. Any building, or portion thereof, utilizing any nondepletable energy source shall meet all the requirements of this chapter. An energy credit will be given to the building envelope in the amount of the net nondepletable energy collected. The nondepletable energy must be derived from a specific collection, storage and distribution system, which may include active and passive systems.

Note: An energy credit to the building envelope in the amount of the net recovered energy will be given to the use of recovery systems which will conserve energy, provided the amount expended is less than the amount recovered when the energy transfer potential and the operating hours are considered.

History: Cr. Register, May, 1978, No. 269, eff. 7-1-78.

ILHR 63.51 Documentation. Proposed alternative designs, submitted as variations to the standard design criteria, shall be accompanied by an energy analysis. This department will accept alternative systems designed according to the requirements of nationally recognized agencies.

History: Cr. Register, May, 1978, No. 269, eff. 7-1-78.

Part VIII—System Analysis Design

ILHR 63.60 Annual energy consumption. A building designed in accordance with this part will be deemed as complying with this chapter if the calculated annual energy consumption is not greater than a similar building with enclosure elements and energy consuming systems designed in accordance with parts I through VI of this chapter. If the proposed alternative design results in an increase in consumption of one energy source and a decrease in another energy source, the difference in each energy source shall be converted to equivalent energy units for purposes of comparing the total energy used.

History: Cr. Register, May, 1978, No. 269, eff. 7-1-78.

ILHR 63.61 Simulation. The calculation procedure used to simulate the operation of the building and its service systems through a full year operating period shall be detailed to permit the evaluation of the effect of system design, climatic factors, operational characteristics, and mechanical equipment on annual energy usage. Manufacturer's data or comparable field test data shall be used when available in the simulation of all systems and equipment. The calculation procedure shall be based upon 8,760 hours of operation of the building and its service systems and shall utilize the following input:

(1) **CLIMATIC DATA:** Coincident hourly data for temperatures, solar radiation, wind and humidity of typical days in the year representing seasonal variation.

(2) **BUILDING DATA:** Orientation, size, shape, thermal mass, air moisture and heat transfer characteristics.

(3) **OPERATIONAL CHARACTERISTICS:** Temperature, humidity, ventilation, illumination, control mode for occupied and unoccupied hours.

(4) **MECHANICAL EQUIPMENT:** Design capacity, partial load profile.

(5) **BUILDING LOADS:** Internal heat generation, lighting, equipment, number of people during occupied and unoccupied periods.

History: Cr. Register, May, 1978, No. 269, eff. 7-1-78.

ILHR 63.62 Documentation. Proposed alternative designs, submitted as requests for exception to the standard design criteria, shall be accompanied by an energy analysis comparison report. The report shall provide technical detail on the building and system design and on the data used.

History: Cr. Register, May, 1978, No. 269, eff. 7-1-78.

Chapter ILHR 64

HEATING, VENTILATING AND AIR CONDITIONING

Part I—Scope		ILHR 64.38 Gravity ventilation ducts (p. 375)	
ILHR 64.01	Scope (p. 356)	ILHR 64.39 Ventilation discharge (p. 376)	
ILHR 64.02	Approval of drawings and specifications (p. 356)	ILHR 64.40 Relief vents (p. 376)	
Part II—Design Requirements		ILHR 64.41 Plenums (p. 376)	
ILHR 64.03	Design (p. 356)	ILHR 64.42 Fire dampers and fire curtain doors (p. 378)	
ILHR 64.04	Outside temperature design conditions (p. 356)	ILHR 64.43 Dampers and damper controls (p. 378)	
ILHR 64.05	Inside design temperatures and ventilation requirements (p. 357)	ILHR 64.44 Fans and blowers (p. 379)	
ILHR 64.06	Mechanical ventilation systems (p. 358)	Part VI—Chimneys, Gas Vents, Mechanical Draft and Venting Devices	
ILHR 64.07	Natural ventilation system (p. 361)	ILHR 64.45	Chimneys, smoke stacks, gas vents, mechanical draft and venting devices (p. 379)
ILHR 64.08	Exhaust ventilation system (p. 361)	ILHR 64.46	Masonry chimneys (p. 379)
ILHR 64.09	Combustion air intakes (p. 362)	ILHR 64.47	Metal smokestacks (p. 380)
ILHR 64.10	Refrigerants (p. 363)	ILHR 64.48	Factory-built chimneys and gas vents (p. 381)
Part III Ventilation and Air Standards		ILHR 64.49	Gas vents (p. 381)
ILHR 64.11	Ventilation and air standards (p. 363)	ILHR 64.50	Chimney and vent connectors (p. 382)
ILHR 64.12	Definitions (p. 364)	Part VII—Equipment Location, Protection, Maintenance and Operation	
ILHR 64.13	Tempered air requirements (p. 364)	ILHR 64.51	Guarding and fire protection (p. 383)
ILHR 64.14	Tempered outside air requirements (p. 364)	ILHR 64.52	Maintenance and operation (p. 384)
ILHR 64.15	Air movement and distribution (p. 364)	ILHR 64.53	Final test required (p. 384)
ILHR 64.16	Air-cleansing devices (p. 364)	Part VIII—Occupancy Requirements	
ILHR 64.17	Controls (p. 365)	ILHR 64.54	Factories, office and mercantile buildings (p. 384)
ILHR 64.18	Contamination of air (p. 365)	ILHR 64.55	Theaters and places of assembly (p. 385)
ILHR 64.19	Location of outside ventilating air intakes or exhausts for mechanical ventilation systems (p. 366)	ILHR 64.56	Schools and other places of instruction (p. 385)
Part IV—Heating Equipment Requirements		ILHR 64.57	Health care facilities (p. 386)
ILHR 64.20	Equipment ratings and safety controls (p. 367)	ILHR 64.58	Penal institutions and places of detention (p. 386)
ILHR 64.21	Location of equipment (p. 368)	ILHR 64.59	Residential occupancies (p. 386)
ILHR 64.22	Special requirements (p. 370)	ILHR 64.60	Day care facilities (p. 387)
ILHR 64.23	Piping (p. 372)	ILHR 64.61	Repair areas (p. 387)
Part 5—Air Delivery Systems		ILHR 64.62	Vehicle service buildings (p. 388)
ILHR 64.31	Duct design (p. 373)	ILHR 64.63	Garages (p. 388)
ILHR 64.32	Duct use (p. 373)	ILHR 64.64	Vehicle showroom (p. 388)
ILHR 64.33	Underground duct construction and installation (p. 373)	ILHR 64.65	General sanitation and service areas (p. 389)
ILHR 64.34	Duct construction (p. 374)	ILHR 64.66	Natatoriums (p. 390)
ILHR 64.35	Duct connectors (p. 375)	ILHR 64.67	Kitchens (p. 390)
ILHR 64.36	Vertical shafts (p. 375)	ILHR 64.68	Seasonal occupancies (p. 393)
ILHR 64.37	Insulation (p. 375)		

Note: Chapter Ind 59 as it existed on December 31, 1975 was repealed and a new chapter Ind 64 was created effective January 1, 1976. Chapter Ind 64 was renumbered to be chapter ILHR 64 effective January 1, 1984.

Part I—Scope

ILHR 64.01 Scope. All heating, ventilating and air conditioning systems shall be designed, installed, maintained and operated so as to provide the service and results required within the provisions of this chapter. The minimum requirements established in each part of this chapter shall be complied with as they apply to that specific public building or place of employment. The administrative rules pertaining to energy conservation may be applied retroactively to existing buildings.

Note: Compliance with this code shall not constitute assurance of proper installation or operation of the heating, ventilating and air conditioning system. This code is not to be used as a design manual, but it is established as a minimum standard for safety, health and general welfare of the public.

History: Cr. Register, December, 1975, No. 240, eff. 1-1-76; am. Register, December, 1976, No. 252, eff. 1-1-77.

ILHR 64.02 Approval of drawings and specifications. All drawings and specifications shall be submitted to the department in accordance with the provisions of ss. ILHR 50.07 and 50.12.

History: Cr. Register, December, 1975, No. 240, eff. 1-1-76; am. Register, December, 1976, No. 252, eff. 1-1-77.

Part II—Design Requirements

ILHR 64.03 Design. (1) **BUILDING HEAT LOSS.** The total building heat loss shall be equal to the sum of the building transmission losses and infiltration or ventilation losses, whichever are greater.

(2) **HEATING SYSTEM DESIGN.** The primary heating system intended to maintain the inside design temperature of s. ILHR 64.05 (1) shall be designed to equalize building transmission losses and infiltration or ventilation losses during occupied periods. Credit will be given for internal heat gains against the total design loss of the heating system, provided the heat gains are demonstrated by the designer.

(3) **CAPACITY AND ARRANGEMENT.** The calculated capacity and the arrangement of all installations for required heating and ventilating shall be based upon simultaneous service to all parts of the building unless otherwise exempted by this code.

History: Cr. Register, December, 1975, No. 240, eff. 1-1-76; am. (1) and (2)(a), Register, January, 1980, No. 289, eff. 2-1-80; am. (2), Register, December, 1981, No. 312, eff. 1-1-82.

ILHR 64.04 Outside temperature design conditions. In the accompanying map, the state of Wisconsin has been divided into 4 zones. The maximum heat losses for a heating system shall be calculated on the basis of the outdoor temperatures indicated on the map with reference to location of the project.

History: Cr. Register, December, 1975, No. 240, eff. 1-1-76.
Register, August, 1985, No. 356

MAP OF WISCONSIN SHOWING DESIGN TEMPERATURE ZONES

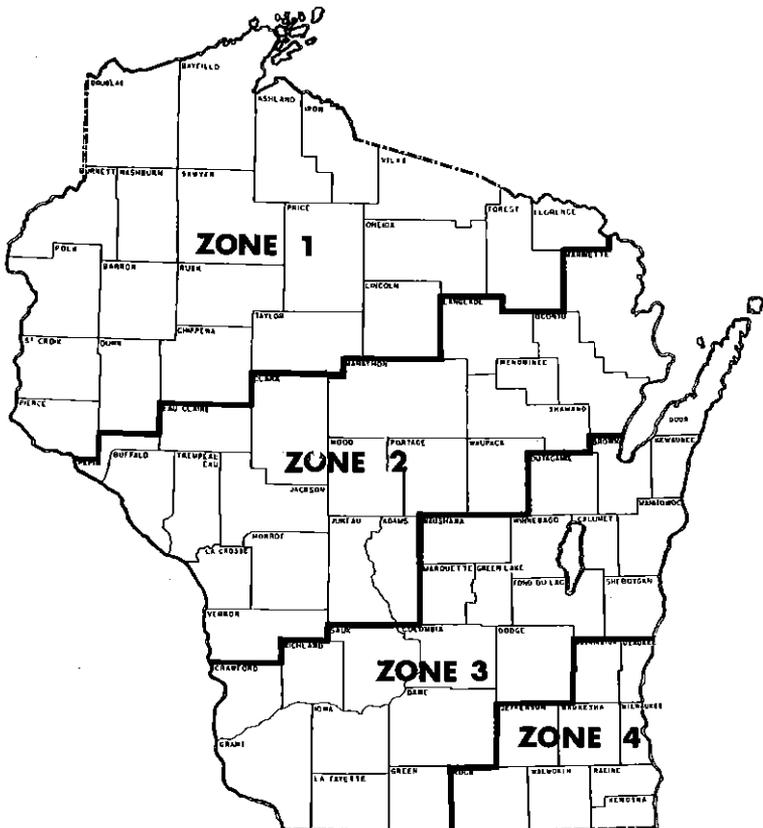

Zone 1	-25° below zero F
Zone 2	-20° below zero F
Zone 3	-15° below zero F
Zone 4	-10° below zero F

ILHR 64.05 Inside design temperatures and ventilation requirements. (1) INSIDE DESIGN TEMPERATURES. The heating system shall be designed to maintain a temperature of not less than that shown in Table 1 and must be operated at not less than that temperature during occupied periods.

(a) *Spot heating.* Spot heating may be used to heat individual fixed work stations in large industrial buildings where it is impractical to provide heat to the entire space as described in (1) above, provided the inside design temperature at the fixed work station is at least 60° F.

(2) **VENTILATION REQUIREMENTS.** The ventilating system shall be designed, maintained and operated to accomplish the required ventilation indicated in Table 1.

(a) *Outdoor air requirement waived.* If a mechanical air supply system is provided and the requirement for outdoor air determined in accordance

with Table 1 is less than 5% of the code required air movement of 6 air changes per hour, the requirement for outdoor air may be eliminated.

(b) *Outdoor air requirement and percent of openings waived.* The requirement for outdoor air or percent of openings may be omitted in large volume spaces containing 5,000 cubic feet per occupant.

History: Cr. Register, December, 1975, No. 240, eff. 1-1-76; cr. (1) (a), (2) (a) and (b), Register, December, 1976, No. 252, eff. 1-1-77; am. (2) (b), Register, December, 1978, No. 276, eff. 1-1-79; am. table, Register, August, 1985, No. 356, eff. 1-1-86.

ILHR 64.06 Mechanical ventilation systems. (1) **DEFINITION.** Mechanical ventilation is the process of supplying a mixture of tempered outside air or simultaneously removing contaminated air to the outside by power-driven fans or blowers or both.

(2) **DESIGN.** Mechanical ventilation systems shall be designed to supply a continuous source of outside air to all occupied areas during occupancy. Exhaust ventilation in equal volume shall be maintained simultaneously.

(3) **AIR MOVEMENT.** The air movement may be based on actual room height or up to 10 feet from the floor level of the room in question. The volume above 10 feet, in rooms which are more than 10 feet in height, need not be considered in the air change requirement if the required air change is designed to occur in the lower 10 feet of the occupied space.

(a) *Six air changes per hour.* The total air movement for all occupancies shall be at least 6 air changes per hour as specified in Table 1 of s. ILHR 64.05.

(b) *Less than 6 air changes per hour.* An air movement of less than 6 air changes per hour will be permitted where mechanical cooling (air conditioning) is provided and the heat gain requirement for the space has been satisfied.

(c) *Air movement requirement waived.* The air movement requirement for 6 air changes per hour may be omitted in the following applications:

1. Spot heating.
2. Buildings where the requirement for outside air is waived in accordance with s. ILHR 64.05(2)(b).
3. Buildings utilizing percentage of openings as specified in s. ILHR 64.05, Table 1.

(4) **AIR DISTRIBUTION.** An adequate number of air supply, return and exhaust outlets or grilles shall be provided to insure a uniform distribution of air.

(5) **RECIRCULATION AND TRANSFER OF AIR.** (a) *Recirculation.* No air contaminated by any source other than human occupancy shall be recirculated, except within the same ventilation classification.

ILHR 64.05 TABLE 1

Use or Occupancy	Minimum Inside Temp. (Deg. F)	Ventilation Classification ²	Ventilation Requirements			Applicable Occupancy Code Section (ILHR No.)
			Basis of Capacity			
			Determination of No. of Persons ³ Net sq. ft. per person	Percent of Openings ⁴	CFM/net sq. ft. Floor Area	
Factories, office and mercantile buildings						
Barber and beauty salons (where hair spray is used)	67	(b)	20	3	—	64.54
Canning factories	60	(b)	75	3	—	64.54, 64.68
Conference rooms	67	(b)	7	3	—	64.54
Court rooms	67	(b)	6	3	—	64.54
Factories and machine shops	60	(b)	75	3	—	64.54
First aid rooms	67	(b)	6	3	—	64.54
Flammable liquids storage	NMR	(d)	—	—	—	64.18
Foundries and boiler shops	50	(b)	75	3	—	64.13, 64.54
Funeral homes:						
Chapel	67	(b)	6	3	—	64.54
Embalming room	67	(d)	—	—	2	64.54
Offices	67	(b)	75	3	—	64.54
Places of worship, entertainment and recreation which accommodate less than 100 persons	†	(b)	†	3	—	64.54
Printing establishments	60	(b)	—	3	—	64.18, 64.54
Retail establishments (basement)	65	(b)	40	3	—	64.54
(other floors)	65	(b)	60	3	—	64.54
Shopping malls corridor areas (except mercantile areas)	NMR	(g)	Aggregate capacity of stores served by mall	—	—	64.54
Security vaults (occupied)	65	(a)	300	—	—	64.54
Warehouses	NMR	—	—	—	—	64.18, 64.54
Theaters and places of assembly (which accommodate more than 100 persons)						
Arenas and field houses (use seated area)	60	(a)	6	—	—	64.55
Armory drill floors	35	(b)	30	3	—	64.55
Assembly halls (other than church)	67	(a)	6	—	—	64.55
Bowling alleys	67	(a)	15	—	—	Based on occupied areas
Cafeterias, dining areas, restaurants, billiard rooms	67	(a)	15	—	—	64.55
Churches and places of worship:						
Chapels	67	(b)	6	3	—	64.55 (3)
Dining and social rooms	67	(b)	15	3	—	64.55 (3)
Nave or auditorium	67	(b)	6	3	—	64.55 (3)
Sunday school rooms	67	(b)	20	3	—	64.55 (3)
Club rooms (seated)	67	(a)	6	—	—	64.55
(unseated)	67	(a)	15	—	—	64.55
Dance halls	67	(a)	15	—	—	64.55
Ice skating rinks (indoor)	NMR	(a)	15	—	—	64.55
Ice resurfacing (indoor)	NMR	(d)	—	—	—	64.18, 64.55
Lodge halls	65	(a)	15	—	—	64.55
Roller skating rinks (indoor)	50	(a)	15	—	—	64.55
Taverns	67	(a)	20	—	—	64.55
Tennis courts (indoor)	60	(a)	—	—	—	64.55
Theaters	67	(a)	6	—	—	64.55
Lobbies	65	(a)	15	—	—	64.55
Lounge rooms	67	(a)	15	—	—	64.55
Motion picture booths	60	(a) or (c)	—	—	2	64.55 (5)
Health Care Facilities			See ILHR 64.57			

CA = Cooking appliance.

LF = Lineal foot.

NMR = No minimum requirements.

TF = Toilet facilities (water closets and urinals).

†See Theaters and places of assembly for inside design temperature and net square feet per person.

¹Ventilation requirements. See ss. ILHR 64.06, 64.07 and 64.08 for mechanical, natural and exhaust ventilation systems; and ss. ILHR 64.11 to 64.18 for ventilation and air standards.

²Ventilation classifications.

- (a) Requires a supply of outside air and an equal amount of exhaust ventilation be provided at the rate of 5 CFM per person and a minimum air movement of 6 air changes per hour.
- (b) Requires a supply of outside air and an equal amount of exhaust ventilation be provided at the rate of 5 CFM per person and a minimum air movement of 6 air changes per hour, or a percentage of openings.
- (c) Requires a supply of outside air and exhaust ventilation determined on the basis of CFM per square foot of floor area.
- (d) Requires exhaust ventilation determined on the basis of CFM per square foot of floor area. The area shall be provided with negative pressure relative to adjacent areas. A supply of outside air is required when the total building exhaust exceeds one air change per hour, unless otherwise exempted. In multiple-use occupancies, the area of each occupancy shall be considered separately.
- (e) Requires a supply of outside air and exhaust ventilation determined on the basis of CFM per square foot of floor area. The area shall be provided with a negative pressure relationship with respect to the adjacent areas.
- (f) Requires a percentage of openings.
- (g) Does not require a separate supply of outside air provided the outside air introduced in the store areas adjacent to the mall is circulated through and exhausted from the shopping mall corridor area.

³Determination of number of persons. In determining the number of occupants in a given space, the department will accept the net square feet per person as listed in Table 1 or the actual number of persons, provided the expected occupancy is indicated on the plans and is reasonable. Where no value is indicated for net square feet per person, the actual number of occupants shall be used to determine the required amount of outside air.

⁴Percent of openings. See ss. ILHR 64.07 for special considerations on natural ventilation.

ILHR 64.05 TABLE 1 (CONTINUED)

Use or Occupancy	Minimum Inside Temp. (Des. F)	Ventilation Requirements ¹			Applicable Occupancy Code Section (ILHR No.)
		Ventilation Classification ²	Basis of Capacity		
			Determination of No. of Persons ³ Net sq. ft. per person	Percent of Openings ⁴	
Schools and other places of instruction					
Administrative office space	67	(b)	75	3	64.56
Arts, crafts, drafting rooms	67	(a)	30	—	64.56
Classrooms	67	(a)	20	—	64.56
Gymnasiums, field houses, auditoriums, theaters (fixed seats)	67	(a)	6	—	64.56
Bleachers	—	(a)	2.75 or 18 ² /TF	—	64.56
Locker and shower rooms	70	(c) or (d)	—	—	64.65
Gymnasiums, field houses, auditoriums theaters (nonseated areas)	55	(a)	75	—	64.56
Home economics	67	(a)	30	—	64.56
(cooking)	67	(d)	—	200/CA	64.67
Kitchens	60	(c) or (d)	—	2	64.67
Laboratories (science)	67	(a)	30	—	64.18
Lecture halls	67	(a)	6	—	64.56
Library and resource centers	67	(a)	20	—	64.56
Reading rooms	67	(a)	20	—	64.56
Stack areas	67	(a) or (d)	100	1/4	64.56
Lunchrooms	65	(a)	10	—	64.56
Museums and art galleries	67	(a)	40	—	64.56
Music rooms (instrumental) (vocal)	67	(a)	20	—	64.56
Special education	67	(a)	10	—	64.56
Study halls, common areas with nonfixed seating	67	(a)	35	—	64.56
Toilet rooms	65	(d)	—	—	64.56
				2 or 60/TF	64.65
Vocational shops:					
With vehicle service and repair	60	(c) or (d)	—	—	64.18
Without vehicle service and repair	60	(a)	50	—	64.18
Wardrobes	NMR	(d)	—	—	64.65
Detention and correctional facilities					
Sleeping rooms	67	(b)	—	4	64.58
Residential occupancies					
Living and sleeping areas	67	(f)	—	4	64.59
Day care facilities					
	67	(b)	35	4	64.60
Garages and service stations					
Automobile showrooms:					
Less than 6 vehicles	60	(b)	—	3	64.64
6 or more vehicles	60	(c) or (d)	—	—	64.64
				1/2	64.63, 64.63
Garages: less than 6 vehicles	NMR	(b)	—	3	64.63
Garages: 6 or more vehicles	NMR	(c) or (d)	—	—	64.63
				1/2	64.61
Repair areas	60	(c) or (d)	—	—	64.61
Vehicle service buildings	60	(c) or (d)	—	—	64.62
				1/2	64.62
General sanitation and service areas					
Chlorine storage rooms	NMR	(d)	—	—	64.65
Janitor closets	NMR	(d)	—	—	64.65
Locker rooms and shower rooms	70	(c) or (d)	—	—	64.65
Toilet rooms	65	(d)	—	—	64.65
				2 or 60/TF	64.65
Toilet rooms (w/outdoor stadium)	50	(d)	—	—	64.65
				2 or 60/TF	64.65
Laundries					
	60	(c)	—	—	64.65
Natatoriums					
	76	(c)	—	—	64.66
				1 or 2/ pool sq	64.66
Kitchens					
	60	(c) or (d)	—	—	64.67
				2	64.67
Seasonal occupancies					
Camps and lodges:					
Dining and recreational areas	NMR	(b)	15	3	64.68
Living and sleeping areas	NMR	(f)	—	4	64.68
Club houses	NMR	(b)	15	3	64.68
Drive-ins	NMR	(b)	15	3	64.68
Kitchens	NMR	(c) or (d)	—	—	64.67
Outdoor toilets	NMR	(d)	—	—	64.65

CA = Cooking appliance.

LP = Lineal foot.

NMR = No minimum requirements.

TF = Toilet facilities (water closets and urinals).

¹See theaters and places of assembly for inside design temperature and net square feet per person.

¹Ventilation requirements. See ss. ILHR 64.06, 64.07 and 64.08 for mechanical, natural and exhaust ventilation systems; and ss. ILHR 64.11 to 64.18 for ventilation and air standards.

²Ventilation classifications.

(a) Requires a supply of outside air and an equal amount of exhaust ventilation be provided at the rate of 5 CFM per person and a minimum air movement of 6 air changes per hour.

(b) Requires a supply of outside air and an equal amount of exhaust ventilation be provided at the rate of 5 CFM per person and a minimum air movement of 6 air changes per hour, or a percentage of openings.

(c) Requires a supply of outside air and exhaust ventilation determined on the basis of CFM per square foot of floor area.

(d) Requires exhaust ventilation determined on the basis of CFM per square foot of floor area. The area shall be provided with negative pressure relative to adjacent areas. A supply of outside air is required when the total building exhaust exceeds one air change per hour, unless otherwise exempted. In multiple-use occupancies, the area of each occupancy shall be considered separately.

(e) Requires a supply of outside air and exhaust ventilation determined on the basis of CFM per square foot of floor area. The area shall be provided with a negative pressure relationship with respect to the adjacent areas.

(f) Requires a percentage of openings.

(g) Does not require a separate supply of outside air provided the outside air introduced in the store areas adjacent to the mall is circulated through and exhausted from the shopping mall corridor area.

³Determination of number of persons. In determining the number of occupants in a given space, the department will accept the net square feet per person as listed in Table 1 or the actual number of persons, provided the expected occupancy is indicated on the plans and is reasonable. Where no value is indicated for net square feet per person, the actual number of occupants shall be used to determine the required amount of outside air.

⁴Percent of openings. See ss. ILHR 64.07 for special considerations on natural ventilation.

(b) *Transfer.* Air in a volume equal to the outside air required for a room may be transferred through a corridor and exhausted through a locker room, toilet room, kitchen, janitor closet or a similar area. Air shall not be transferred through elevator shafts and stairwells where doors are required at any floor level.

(6) **DIVERSIFIED MECHANICAL SYSTEMS.** If the mechanical ventilation system is able to deliver required quantities of outside air to each area when needed, the department will recognize diversity and the system may be designed on the actual occupancy.

Note #1: This rule permits the opening of outside air intakes in schools, offices and retail establishments to be delayed one hour after initial occupancy and permits the closing of outside air openings one hour prior to the termination of the occupancy.

Note #2: See ch. Ind 1000-2000, Safety & Health Code, for requirements for dust, fumes, vapors and gases.

History: Cr. Register, December, 1975, No. 240, eff. 1-1-76; renum. (3) to be (6), renum. 64.15 (2) to be (3), 64.15 (3) to be (4), cr. (3) (c) and (5), Register, December, 1976, No. 252, eff. 1-1-77; am. (3)(c)2., Register, January, 1980, No. 289, eff. 2-1-80; am. (3) (c) 3., Register, December, 1981, No. 312, eff. 1-1-82.

ILHR 64.07 Natural ventilation system. (1) OUTDOOR OPENINGS. Outdoor openings used for natural ventilation shall be within 100 feet, or 5 times the least dimensional width of the occupied area, whichever is the least.

(a) *Outdoor openings located below grade.* Outdoor openings below grade will not be accepted unless there is a clear space outside of the opening having a width not less than 1½ times the distance below grade at the bottom of the opening.

Note: Width of clear space is the horizontal distance measured at right angles to the plane of the opening.

(b) *Outdoor openings located from a property line.* Outdoor openings shall be at least 5 feet from a property line or lot line or both or an adjacent building on the same property. This distance restriction does not apply to property lines along streets.

Note: For further restrictions, see Table 51.03-B and s. ILHR 64.19.

(2) **VESTIBULE OPENINGS.** Vestibule type openings may be used to satisfy the requirements specified in sub. (1) only for the areas of the building into which the vestibule opens.

History: Cr. Register, December, 1975, No. 240, eff. 1-1-76; cr. (2), Register, December, 1981, No. 312, eff. 1-1-82.

ILHR 64.08 Exhaust ventilation system. (1) DEFINITIONS. (a) Exhaust ventilating system. Any combination of building construction, machinery, devices or equipment, designed and operated to remove harmful gases, dusts, fumes or vitiated air from the breathing zone of employes and frequenters. **FP**

(b) *Gravity exhaust ventilation.* A process of removing air by natural means, the effectiveness depending on atmospheric condition, such as difference in relative density, difference in temperature or wind motion.

(2) **DESIGN.** Exhaust ventilating systems shall be designed to reasonably prevent contaminated air from reentering the building.

(3) **OPERATION.** The required building exhaust ventilating systems shall operate continuously during periods of occupancy.

(4) **EXHAUST VENTS.** All exhaust vents shall be ducted to the exterior of the building.

(5) **GRAVITY SIPHON-TYPE ROOF VENTILATORS.** (a) Except as provided in par. (b), gravity siphon-type roof ventilators shall be sized to provide a free area so that the velocity of the air does not exceed 300 feet per minute.

(b) The allowable velocity specified in par. (a) may be increased to 600 feet per minute provided the outside air is supplied by mechanical means.

Note: Heat reclaim equipment for exhaust systems having more than 10,000 CFM capacity should be considered for energy savings.

History: Cr. Register, December, 1975, No. 240, eff. 1-1-76; cr. (4), Register, December, 1976, No. 252, eff. 1-1-77; cr. (5), Register, December, 1983, No. 336, eff. 1-1-84.

FP ILHR 64.09 Combustion air intakes. Any room in which fuel-burning equipment, including fireplaces and process equipment, is located shall be supplied with combustion air for safe operation.

(1) **COMBUSTION AIR.** Combustion air shall be provided by one of the following methods:

(a) *Combustion air by gravitational means.* Where combustion air is introduced by gravitational means, the minimum free area for combustion air intakes shall be calculated in square inches as indicated in Table 64.09. The values for gas- and oil-fired equipment are based on the fuel input of the equipment. The value for solid-fuel equipment and fireplaces is based on the fuel input of the equipment, the area of the chimney connector or the listing for the specific piece of equipment. (See Table 64.09).

TABLE 64.09

Atmospheric Combustion	Combustion Air Intakes Ducted from the Outside to an Interior Room or Fireplace	Combustion Air Intakes Located at the Outside Wall of an Exterior Room
Gas-fired, all occupancies except industrial	1 sq.in./1000 Btu/hr.	1 sq.in./2000 Btu/hr.
Gas-fired, industrial occupancies	1 sq.in./1000 Btu/hr.	1 sq.in./5000 Btu/hr.
Oil-fired, all occupancies	1 sq.in./1000 Btu/hr.	1 sq.in./2000 Btu/hr.
Solid-fuel fired equipment and fireplaces, all occupancies	1 sq. in./1000 Btu/hr for furnace type units. ½ of the chimney connector area for free standing and fireplace type units. In accordance with equipment listing, if listing includes combustion air provisions.	

(b) *Combustion air for power burners.* The minimum free area for combustion air intakes for power burners shall be at least .5 square feet per 1,000,000 Btu per hour fuel input with a minimum free area of 10 square inches.

(c) *Combustion air by mechanical means.* Combustion air furnished by mechanical systems, such as makeup air units, may be used when complete design data is submitted and approved by the department.

(d) *Combustion air by infiltration.* If the heating equipment is not required to be located in a fire-resistive room, combustion air may be provided by means of infiltration where the total area of outdoor openings is greater than 3% of the floor area in which the equipment is located, or where 150% of the air required for theoretical complete combustion is no greater than ¼ air change govern the design.

Note: See s. ILHR 64.22 for special conditions.

(2) **DAMPERS.** (a) Manually operated dampers are prohibited in combustion air intakes, except for manually fired solid-fuel fired equipment, where the combustion air is connected directly to the equipment.

(b) Motorized dampers are acceptable when interlocked with the burner. Dampers shall be open when the burner is in operation. A safety interlock switch shall be installed to insure that the damper is in an open position before the burner is permitted to operate.

(3) **DUCTWORK.** Where ductwork is required to bring combustion air into the building, the duct shall have the same cross-sectional area as the free area of the combustion air openings.

(4) **SEGREGATION OF COMBUSTION AIR.** The combustion air path shall be completely segregated from the outside air ventilation ductwork.

(5) **NEGATIVE PRESSURE LOCATIONS.** Atmospheric combustion shall be prohibited in a space under negative pressure.

(6) **MOUNTING HEIGHT.** Mounting height of the combustion air intakes shall be as required in s. ILHR 64.19 (1) (c).

(7) **AIR-HANDLING EQUIPMENT LOCATED IN A BOILER OR FURNANCE ROOM.** If the fuel input rating of the fuel burning equipment exceeds 400,000 Btu per hour, the air-handling equipment and the fuel-burning equipment shall be interlocked to shut off the fuel-burning equipment and the air-handling equipment when any service door to the air-handling equipment is opened, unless an air barrier separation is provided between the fuel-burning equipment and the air handling equipment.

History: Cr. Register, December, 1975, No. 240, eff. 1-1-76; r. and recr. Register, December, 1976, No. 252, eff. 1-1-77; renum. (1) (b) and (c) to be (c) and (d), cr. (1) (b), and am. (7), Register, December, 1977, No. 264, eff. 1-1-78; am. (5), Register, December, 1978, No. 276, eff. 1-1-79; am. (1)(d), Register, January, 1980, No. 289, eff. 2-1-80; am. (1)(a) and (d) (2)(a), (5) and (7), Register, December, 1981, No. 312, eff. 1-1-82; am. (1) (d), Register, December, 1983, No. 336, eff. 1-1-84.

ILHR 64.10 Refrigerants. The rules covering the use of refrigerants for air conditioning systems shall conform with ch. ILHR 45, Mechanical Refrigeration.

History: Cr. Register, December, 1975, No. 240, eff. 1-1-76.

Part III—Ventilation and Air Standards

ILHR 64.11 Ventilation and air standards. The quantity of air used to ventilate a given space during periods of occupancy shall always be suffi-

cient to maintain the standards of air distribution, air movement, recirculation, 64.12 to 64.19.

History: Cr. Register, December, 1975, No. 240, eff. 1-1-76.

ILHR 64.12 Definitions. (1) "Air conditioning." The process of treating air to control temperature, humidity, cleanliness and distribution to meet the requirements of the conditioned space.

(2) "Outside air." Air that is taken from outside the building and is free from contamination of any kind in proportions detrimental to the health or comfort of the persons exposed to it.

(3) "Recirculated air." The transfer of air from a space through the air-handling equipment and back to the space.

(4) "Tempered air." Air transferred from a heated or cooled area of a building.

(5) "Tempered outside air." Outside air heated or cooled before distribution.

(6) "Ventilation." The process of supplying or removing air by natural or mechanical means, to or from any space.

History: Cr. Register, December, 1975, No. 240, eff. 1-1-76; reprinted to correct error in (6), Register, December, 1985, No. 360.

ILHR 64.13 Tempered air requirements. (1) **SUPPLY AIR.** The design conditions of the supply air temperature to the occupied space shall be between 50° F. and 140° F.

(2) **TEMPERED AIR SUPPLY DEPENDING ON NEGATIVE PRESSURE.** A supply of tempered air, depending on a negative pressure within the space, will be permitted in foundries, steel fabricating shops and similar areas.

History: Cr. Register, December, 1975, No. 240, eff. 1-1-76.

ILHR 64.14 Tempered outside air requirements. (1) **MAKEUP AIR.** A supply of tempered outside air shall be provided when the total volume of building exhaust from an area exceeds one air change per hour.

Note: See Ch. Ind 1000-2000, Safety & Health Code, for further requirements for makeup air for industrial exhaust systems.

(2) **PROCESS HEAT.** Process heat may be used to temper required outside air.

History: Cr. Register, December, 1975, No. 240, eff. 1-1-76.

ILHR 64.15 Air movement and distribution. The air delivery capacity of all equipment supplying air for heating, ventilating and air conditioning purposes shall be based on standard air ratings.

Note: Standard air is substantially equivalent to dry air at 70° F. and 29.92 inches (Hg) barometric pressure.

History: Cr. Register, December, 1975, No. 240, eff. 1-1-76; renum. (2) and (3) to be 64.06 (3) and (4), r. (4), Register, December, 1976, No. 252, eff. 1-1-77.

FP ILHR 64.16 Air-cleansing devices. (1) **AIR-CLEANSING ACCESS.** Air-cleansing devices shall be designed and installed to permit access to the equipment for maintenance and to insure proper operation of the heating and ventilating system.

Register, December, 1985, No. 360

(2) **AIR-CLEANSING FILTERS.** Approved air-cleansing filters shall be designed and installed in a manner to filter the outside air and recirculated air used with mechanical heating and ventilating systems except as follows:

(a) Filters are not required in garages, factories, foundries and similar occupancies;

(b) Filters are not required for use with unit heaters designed for heating and recirculation; or

(c) Where jet systems or blend-air systems are approved, air filters are not required in the ducts that are installed for the recirculation of air within the same occupied space.

Note: The department recognizes as approved, filters listed in the Building Materials List published by Underwriters' Laboratories, Inc., and test data of any other recognized testing agency for the purpose for which it is used.

(3) **AIR-CLEANSING MATERIALS.** Contaminated water shall not be used or recirculated through sprays affecting air used for ventilating purposes.

History: Cr. Register, December, 1975, No. 240, eff. 1-1-76

ILHR 64.17 Controls. (1) **GENERAL.** Except as provided in sub. (2), automatic controls shall be provided to maintain design temperature, control ventilation to provide a continuous air movement of not less than the minimum required by this chapter, and to provide a continuous supply of outside air and exhaust determined by the provisions of s. ILHR 64.05, Table 1, during periods of occupancy.

(2) **EXCEPTION.** Manual control of solid-fuel fired equipment to maintain inside design temperature is permitted.

History: Cr. Register, December, 1975, No. 240, eff. 1-1-76; am. Register, December, 1981, No. 312, eff. 1-1-82.

ILHR 64.18 Contamination of air. (1) **CONTAMINATION.** Air contaminated from odors, fumes, noxious gases, smoke, steam, dust, spray, or other contamination shall be diluted with uncontaminated air or exhausted to prevent the contaminated air from spreading to other parts of the building occupied by people.

Note: For requirements pertaining to all places of employment or occupancy where smoke, gas, dust, fumes, steam, vapor, industrial poisons, or other detrimental materials are used, stored, handled, or are present in the air in sufficient quantities to obstruct the vision, or to be injurious to the health, safety or welfare of the employes or frequenters, see Ch. Ind 1000-2000—Safety and Health Code.

(a) **Chlorinated hydrocarbons.** Areas where chlorinated hydrocarbons are introduced shall be arranged to satisfy the following conditions:

Note: Some of the chlorinated hydrocarbons commonly used are: trichloroethylene, perchloroethylene, carbon tetrochloride, methylene chloride, methyl chloroform, Freon F-11, Freon F-12, Freon F-21 and Freon F-114. For example, these materials are used in dry cleaning establishments, in degreasing operations, and where pressure can propellants are used. Pressure cans are used for such products as enamels, lacquers, paint removers, stencil inks, lubricants, pesticides, hair sprays, shaving lathers, shampoos and colognes.

1. The area shall have an exhaust system capable of maintaining a negative pressure within the enclosed area.

2. The volume and distribution of air movement within the area shall be such that the average threshold limit values of specific airborne contaminants are not exceeded.

Note: See chs. Ind 1000-2000, Wisconsin Safety and Health Code.

3. No fuel-fired heating unit, with or without a heat exchanger, shall be located within this area, nor shall it recirculate air from this area.

4. The surface temperatures of any type of heating equipment used in these areas shall be below the temperature at which toxic materials may be released.

Note: Toxic materials are those covered in Ch. Ind 1000-2000—Safety and Health Code.

(b) *Transfer of contaminated air.* Air shall not be transferred from an area of greater contamination.

Note: The department will accept air transferred from: corridor to toilet room; corridor to cloak room or janitor closet; dining room to kitchen; locker room to toilet room; gymnasium to locker room; showroom to garage; and corridor to school vocational shops.

History: Cr. Register, December, 1975, No. 240, eff. 1-1-76; am. (1)(a)3., Register, January, 1980, No. 289, eff. 2-1-80.

ILHR 64.19 Location of outside ventilating air intakes or exhausts for mechanical ventilation systems. (1) LOCATION AND DISTANCE. (a) *Location to prevent contamination.* Outside air intake openings shall be located so as to minimize contamination of outdoor air, but in no case shall the distance be less than 10 feet measured in any direction from outlets emitting products of combustion, exhaust vents and plumbing vents. Openable windows are exempt from the provisions of this paragraph, except that power vents from gas-fired equipment shall be located at least 12 inches measured in any direction from any openable windows.

Note: This requirement also applies to roof-top heating and ventilating equipment.

(b) *Distance to adjacent properties.* Air intakes and exhausts shall be at least 10 feet from a property line or lot line or both or an adjacent building on the same property. This distance restriction does not apply to property lines along streets or alleys.

(c) *Mounting height.* The lowest side of outside air intake openings shall be located at least 12 inches above outside grade, above adjoining roof surfaces, or above the bottom of an areaway.

Note: The department will accept outside air intakes in areaways provided the minimum horizontal cross section of the areaway is equal to the free area of the opening, a grating is provided over the areaway with a free area equal to the required air intake, and the grating is designed for a minimum of 100 PSF live load. A guardrail, as defined in s. ILHR 51.162, will be accepted in lieu of the grating.

(2) SCREENS. All outside air intake openings shall be provided with a device to prevent intake of foreign material of ½ inch size or larger.

(3) WEATHER PROTECTION. All outside air intake openings shall be protected against weather and water with a weatherproof hood or louvers.

(4) ACCESSIBILITY AND CLEANLINESS. All outside air intakes shall be easily accessible for cleaning and shall be kept clean and sanitary.

(5) DAMPERS. (a) *Intake.* All required outside air intakes shall be equipped with a damper with automatic controls which will close the Register, May, 1988, No. 389

damper and prevent the intake of outside air into the building when the ventilating unit is not in operation.

(b) *Exhaust.* All exhaust openings shall be provided with automatic or self-activating back-draft dampers to prevent the intake of outside air into the building when the exhaust units are not in operation.

History: Cr. Register, December, 1975, No. 240, eff. 1-1-76; am. (5) (a), Register, December, 1976, No. 252, eff. 1-1-77; reprinted to correct error in (1) (c), Register, December, 1985, No. 360.

Part IV—Heating Equipment Requirements

ILHR 64.20 Equipment ratings and safety controls. (1) **TEST AND INSTALLATION STANDARDS.** All oil- and gas-fired heating equipment, electric heating equipment, solid-fuel heating equipment and accessory equipment or devices shall be tested and installed in accordance with standards recognized by the department. Department review and approval of input or output ratings or both are required when ratings are needed to satisfy s. ILHR 64.03 or 64.09.

Note: For a list of standards acceptable to the department, refer to Appendix A.

(2) **SAFETY CONTROLS.** (a) *General.* The complete safety control package for the heating and ventilating equipment shall comply with standards accepted by the department.

(b) *Limits and controls.* Oil and gas-fired heating equipment and electric heating equipment shall be equipped with primary (flame safeguard) safety controls, safety limit switches, and burners or electric elements that comply with standards accepted by the department.

Note: The department recognizes UL 296—Oil Burners, and UL 795—Commercial-Industrial Gas-Heating Equipment, as acceptable standards that satisfy the requirements of subs. (1) and (2).

(3) **LISTED EQUIPMENT.** Complete factory assembled heating units shall be labeled by listing agencies approved by the department.

Note: The department accepts heating equipment listed by American Gas Association (AGA), Underwriters' Laboratories—(UL) and PFS corporation.

(4) **UNLISTED EQUIPMENT.** If the heating equipment is unlisted, the following provisions shall be taken:

(a) *Manufacturer's statement.* A statement from the equipment manufacturer shall be provided indicating the national standard with which the equipment complies.

(b) *Tests.* A test by a Wisconsin registered engineer shall be conducted on the output and safety controls, in accordance with the national standard used by the manufacturer. A statement regarding the test of the rating and safety controls shall be furnished for each installation unless an approval for the equipment is obtained from the department in accordance with sub. (5).

(5) **EQUIPMENT APPROVAL.** Equipment approval may be obtained from the department upon submission of a technical report, based on the test

required in sub. (4) (b), together with the fee as specified in ch. Ind 69 for equipment approval.

Note: The purpose of the technical report is to show that the equipment is in complete compliance with the national standard by which the equipment is designed, constructed and tested.

History: Cr. Register, December, 1975, No. 240, eff. 1-1-75; r. and recr. Register, December, 1976, No. 252, eff. 1-1-77; am. (5), Register, December, 1977, No. 264, eff. 1-1-78; am. (1), Register, December, 1981, No. 312, eff. 1-1-82.

ILHR 64.21 Location of equipment. The various types of heating equipment for the corresponding types of occupancies in which the equipment may be located shall be installed as specified in Table 64.21.

Note #1: The footnotes below the table designate special requirements for the listed equipment.

Note #2: The department will accept net ratings as listed by Mechanical Contractors Association of America, Inc., Institute of Boiler and Radiator Manufacturers, and equipment tested according to commercial standard 140-47.

TABLE 64-21 - LOCATION OF EQUIPMENT

Location and Type of Occupancy	VENTED UNITS										UNVENTED UNITS			ELECTRIC Furnaces, Unit Heaters, Heat Pumps, Baseboard Heaters, etc.	WATER OR STEAM Unit Ventilators, Heaters, Makeup Air Units, Baseboard Heaters, etc.
	Gas or Oil or Solid Fuel Boilers	Gas or Oil or Solid Fuel Furnaces	Gas or Oil Unit Heater	Gas or Oil Infrared		Gas or Oil Space Heater	Solid Fuel Space Heater ^{1,2}	Gas Direct Vent Sealed Combustion Appliance ¹⁰	Gas Direct Fired Makeup Air ^{3,4}	Gas Infrared	Rated Enclosure Not Required	Suspended ⁵	Suspended ⁵		
				Closed Combustion Infrared Equipment with Surface Temperatures not Exceeding 1500°F	Open Flame Infrared Equipment with Sur- face Temperatures Exceeding 1500°F										
	Rated Enclosure	Rated Enclosure	Suspended ⁵	Suspended ⁵	Suspended ⁵										
Type of Occupancy															
Factories	Yes ⁵	Yes ⁵	Yes	Yes	Yes	Yes	Yes	Yes	Yes	Yes	Yes	Yes	Yes	Yes	
Restaurants Buildings	Yes ⁵	Yes	Yes	Yes	Yes	Yes	Yes	Yes	N.P.	N.P.	N.P.	N.P.	N.P.	N.P.	
Office Buildings	Yes ⁵	Yes	Yes	Yes	Yes	Yes	Yes	Yes	N.P.	N.P.	N.P.	N.P.	N.P.	N.P.	
Places of assembly, entertain- ment, recreation, worship or dining (100 persons or less)	Yes ⁵	Yes	Yes	Yes	Yes	Yes	Yes	Yes	N.P.	N.P.	N.P.	N.P.	N.P.	N.P.	
Tennis Facilities (court areas only)	Yes ⁵	Yes	Yes	Yes	Yes	Yes	Yes	Yes	N.P.	N.P.	N.P.	N.P.	N.P.	N.P.	
Tennis Facilities (all other areas)	Yes ⁵	Yes	Yes	Yes	Yes	Yes	Yes	Yes	N.P.	N.P.	N.P.	N.P.	N.P.	N.P.	
Theaters & places of assembly, entertainment, recreation, worship or dining (more than 100 persons)	Yes	Yes	Yes	Yes	Yes	Yes	Yes	Yes	N.P.	N.P.	N.P.	N.P.	N.P.	N.P.	
Restaurants	Yes	Yes	Yes	Yes	Yes	Yes	Yes	Yes	N.P.	N.P.	N.P.	N.P.	N.P.	N.P.	
Tennis Facilities (court areas only)	Yes	Yes	Yes	Yes	Yes	Yes	Yes	Yes	N.P.	N.P.	N.P.	N.P.	N.P.	N.P.	
Tennis Facilities (all other areas)	Yes	Yes	Yes	Yes	Yes	Yes	Yes	Yes	N.P.	N.P.	N.P.	N.P.	N.P.	N.P.	
Schools & Other Places of Instruction	Yes	Yes	Yes	Yes	Yes	Yes	Yes	Yes	N.P.	N.P.	N.P.	N.P.	N.P.	N.P.	
Hospitals, Nursing Homes & Penal Institutions	Yes	Yes	N.P.	N.P.	N.P.	N.P.	N.P.	N.P.	N.P.	N.P.	N.P.	N.P.	N.P.	N.P.	
Residential Occupancies	Yes	Yes	N.P.	N.P.	N.P.	N.P.	N.P.	N.P.	N.P.	N.P.	N.P.	N.P.	N.P.	N.P.	
Hazardous Occupancies	Yes	Yes	N.P.	N.P.	N.P.	N.P.	N.P.	N.P.	N.P.	N.P.	N.P.	N.P.	N.P.	N.P.	
Garages	Yes	Yes	Yes ¹²	Yes ¹²	Yes	Yes	Yes	Yes	N.P.	N.P.	N.P.	Yes ¹²	Yes ¹²	Yes ¹²	
Aircraft Hangars	Yes	Yes	Yes ¹³	Yes ¹³	Yes	Yes	Yes	Yes	N.P.	N.P.	N.P.	Yes ¹³	Yes ¹³	Yes ¹³	
Day Care Centers	Yes ¹⁶	Yes	Yes	Yes	Yes	Yes	Yes	Yes	N.P.	N.P.	N.P.	N.P.	N.P.	N.P.	
Community Based Residential Facilities ¹⁷	Yes	Yes	N.P.	N.P.	N.P.	N.P.	N.P.	N.P.	N.P.	N.P.	N.P.	N.P.	N.P.	N.P.	

N.P. = Not Permitted

Unlisted Occupancies - Use the listed occupancy in the table that is most similar to the subject occupancy.

Clearances - Equipment shall be installed in accordance with the clearance from combustibles indicated in the name plate of the unit.

¹ See s. ILHR 64.22 (7) (d) for fireplace requirements.

² All solid-fuel fired space heaters shall be located in occupied space or in a space provided with approved smoke detectors and located or guarded to maintain clearances to combustibles and prevent accidental damage or contact with hot surfaces. Solid-fuel burning stoves are limited to 150,000 Btu/hr output.

³ Except as provided in Footnote 4, direct-fired makeup air units shall be mechanically exhausted in the range of 90% to 110% of the air supplied.

⁴ See s. ILHR 64.22 (4) for other permitted uses of direct fired unvented natural gas heaters.

⁵ Where permitted, such equipment other than infrared shall be located in an occupied space (see s. ILHR 64.22 (3)) and suspended at least 7 feet above the floor. Infrared equipment shall be located at least 8 feet above the floor. Suspension of solid-fuel fired equipment is not permitted. See s. ILHR 54.14 (3) for additional requirements.

⁶ Permitted with combustion air ducted to unit in occupancies less than 3,000 square feet gross area and with occupant load less than 100 persons.

⁷ Permitted in kitchens to provide makeup air for kitchen exhaust systems if located outside building or in a rated enclosure.

⁹ Permitted only in shops with a 3-hour separation from other areas of the school building.

¹⁰ Permitted only in shops with a 3-hour separation from other areas of the school building.

¹¹ Gas-fired, direct-vent wall furnaces are permitted in apartments and motels.

¹² Suspended heating units are allowed in garages if located at least 8 feet off the floor. Suspension of solid-fuel fired equipment is not permitted.

¹³ Suspended heating units are allowed if located at least 10 feet above the upper surface of the wings or engine enclosure of the aircraft. Suspension of solid-fuel fired equipment is not permitted.

¹⁴ Solid-fuel fired space heaters are permitted in rowhouse units only.

¹⁵ Waste oil burners are permitted provided they are installed on mezzanines or service platforms located at least 8'-0" above the main floor, are visible from the main floor and are guarded as specified in this section.

¹⁶ See s. ILHR 60.25 for smoke detector alternative.

¹⁷ See s. ILHR 61.24 for requirements.

¹⁸ See ss. ILHR 51.01(29a), 54.14(1)(b), 55.29(1)(b), 56.15(1)(c), 57.14(1)(c)5., 59.21, 60.25(1), 62.32(1)(b) and 62.78(1)(b) for additional requirements.

PERMITTED IN ALL OCCUPANCIES

PERMITTED IN ALL OCCUPANCIES

ILHR 64.22 Special requirements. (1) BOILERS AND PRESSURE VESSELS.
(a) *Construction standards.* Boilers and pressure vessels shall be constructed and installed in compliance with the standards of the American Society of Mechanical Engineers, as adopted under chs. ILHR 41-42.

(b) *Installation notification.* The installing contractor shall notify the department of boiler installation, in accordance with the requirements of s. ILHR 41.05, before the boiler or pressure vessel is put into operation.

(2) **FURNACES.** Forced-air heating systems shall be designed to prevent a negative pressure on the heat exchanger.

(3) **SUSPENDED AND GUARDED EQUIPMENT.** Equipment suspended or guarded as specified in s. ILHR 64.21 shall be installed in an occupied space. Suspended or guarded equipment may be used in multiple tenant buildings providing the equipment is located in tenant spaces of an occupancy use where suspended or guarded equipment is permitted. The equipment shall be visible to persons within the room.

(4) **GAS OR OIL-FIRED RADIANT HEATERS AND DIRECT FIRED UNVENTED NATURAL GAS HEATERS.** Gas- or oil-fired radiant heaters and direct fired unvented natural gas heaters are subject to the following provisions:

(a) The heaters shall be equipped with an automatic pilot of the complete shutoff type or with a 100% shutoff electric ignition;

(b) If unvented radiant heaters or direct fired unvented natural gas heaters are used, mechanical means shall be provided to supply at least 4 cfm of outside air per 1000 Btu per hour input of installed heaters;

(c) Gravity siphon-type roof ventilators or mechanical exhaust shall be provided to remove the amount of air supplied. Gravity siphon-type roof ventilators shall be sized to provide a free area so that the velocity of the air does not exceed 600 feet per minute;

(d) Oil-fired radiant heaters shall be equipped with mechanical pressure-atomizing burners; and

(e) Direct fired unvented natural gas heaters shall comply with the provisions of American National Standards Institute (ANSI) standard Z83.4-1980, Direct Gas-Fired Make-Up Air Heaters.

(5) **SPACE HEATERS.** Space heaters shall comply with the following provisions:

(a) The burner of the appliance shall be enclosed with a metal housing so constructed that there will be no open flame and the burner housing shall be effectively guarded against personal contact. The arrangement shall be such that the shield will prevent any combustible material in the vicinity of the appliance from coming in contact with the flame or with the housing that encloses the burner. Oil-fired space heaters shall be equipped with a mechanical pressure atomizing burner; and

(b) Space heaters shall not be equipped with duct extensions beyond the vertical and horizontal limits of the metal enclosure.

(c) The use of unvented space heaters fueled by natural gas, kerosene, alcohol or other fuel shall be prohibited based on the facts of oxygen depletion; contamination from carbon monoxide, carbon dioxide, nitrogen

dioxide, formaldehyde and other combustion-related contaminants; and water vapor development.

(6) **EQUIPMENT IN HAZARDOUS LOCATIONS.** The types of heating and ventilating equipment that may be installed in hazardous locations (as defined in Article 500 of the National Electrical Code as adopted by reference in ch. ILHR 16) are as follows:

(a) Listed low-pressure steam or hot water unit heaters and makeup air units; and

(b) Listed electric units.

(7) **FIREPLACES AND FIREPLACE STOVES.** Masonry fireplaces, factory-built fireplaces and factory-built fireplace stoves shall be constructed and installed in accordance with the NFPA standard No. 211—Standard for Chimneys, Fireplaces and Vents. **FP**

(a) *Masonry fireplaces.* 1. Masonry fireplaces shall be constructed of solid masonry units, stone or reinforced portland or refractory cement concrete.

a. Where a lining of low-duty firebrick complying with the provisions of ASTM C64, or the equivalent, at least 2 inches thick laid-in fire-clay mortar complying with the provisions of ASTM C105, or the equivalent, or other approved lining is provided, the total thickness of back and sides, including the lining, shall be not less than 8 inches.

b. Where the lining described in subpar. a. is not provided, the thickness of back and sides shall be not less than 12 inches.

2. Steel fireplace units incorporating a firebox liner of not less than ¼ inch thick steel and an air chamber shall be installed with masonry to provide a total thickness at the back and sides of not less than 8 inches, not less than 4 inches of which shall be solid masonry.

3. Warm air ducts employed with steel fireplace units of the circulating air type shall be constructed of metal or masonry.

4. Fireplace hearth extensions of approved noncombustible material for all fireplaces shall be provided.

a. Where the fireplace opening is less than 6 square feet, the hearth extension shall extend at least 16 inches in front of, and at least 8 inches beyond each side of the fireplace opening.

b. Where the fireplace opening is 6 square feet or larger, the hearth extension shall extend at least 20 inches in front of, and at least 12 inches beyond each side of the fireplace opening.

c. Where a fireplace is elevated above or overhangs a floor, the hearth extension shall also extend over the area under the fireplace.

d. Fireplaces constructed of masonry or reinforced portland or refractory cement concrete shall have hearth extensions of brick, concrete, stone, tile or other approved noncombustible material properly supported and with no combustible material against the underside thereof. Wooden forms or centers used during the construction of hearth and hearth extension shall be removed when the construction is completed.

5. All wood beams, joists and studs shall be trimmed away from fireplaces. Headers supporting trimmer arches at fireplaces shall be not less than 20 inches from the face of the chimney breast. Trimmers shall be not less than 6 inches from the inside face of the nearest flue lining.

6. Woodwork shall not be placed within 4 inches of the back face of a fireplace.

7. Woodwork shall not be placed within 6 inches of a fireplace opening. Woodwork above and projecting more than 1½ inches from a fireplace opening shall not be placed less than 12 inches from the top of a fireplace opening.

(b) *Factory-built fireplaces and fireplace stoves.* Factory-built fireplaces and fireplace stoves shall be installed according to the requirements of the approval as specified in s. ILHR 64.20.

(c) *Hearth opening protection.* Fireplaces and fireplace stoves shall be equipped with safety screens or glass doors to prevent the escape of sparks and embers.

(d) *Permitted installations.* Fireplaces are permitted in the following applications.

1. In all occupancies within the scope of chs. ILHR 54 and 55;
2. In health care facilities as specified in s. ILHR 58.24 (3);
3. In common use areas and individual living units in all residential occupancies except hotels and motels; and
4. In lobbies and other common use areas of motels and hotels but not in individual sleeping rooms.

(8) **FLOOR-STANDING VENTED OR UNVENTED EQUIPMENT.** Floor-standing, vented or unvented unit heaters, furnaces and boilers in metal fabricating plants, foundries and machine shops are exempt from the requirements of s. ILHR 54.14.

(9) **HEAT EXCHANGER CORROSION PROTECTION.** If the entering air to the heat exchanger of all gas-fired equipment is 30°F or lower, the heat exchanger and burners shall be constructed of corrosion-resistive materials.

History: Cr. Register, December, 1975, No. 240, eff. 1-1-76; r. and recr. Register, December, 1976, No. 252, eff. 1-1-77; r. (4) (d) and renum. (4) (e) to be (d), Register, December, 1977, No. 264, eff. 1-1-78; am. (1) (b) and cr. (7), Register, December, 1978, No. 276, eff. 1-1-79; r. and recr. (2) and (7), Register, December, 1981, No. 312, eff. 1-1-82; r. and recr. (4), cr. (5) (c), (7) (d) and (8), Register, December, 1983, No. 336, eff. 1-1-84; am. (1), (3) (intro.), (4) (b) and (6) (intro.), r. (3) (a) and cr. (9), Register, August, 1985, No. 356, eff. 1-1-86.

ILHR 64.23 Piping. (1) **PIPE SIZES AND ARRANGEMENT.** All supply and return piping carrying steam, hot water or other fluids, air-line piping and auxiliary equipment shall be of appropriate sizes, elevations and arrangements to accomplish the calculated services in practical operation, without undue noise, stress or other detriment.

(2) **EXPANSION AND CONTRACTION.** The piping for the heating system shall be equipped with anchors, expansion swings or joints, supports and similar devices to relieve stress and strains caused by temperature change of the pipe material.

(3) **PIPE INSULATION.** All supply and return piping carrying steam, hot water or other fluids shall be covered with insulating material where the pipes pass through occupied areas and the surface temperature exceeds 180° F., unless guarded.

(4) **PIPE PROTECTION.** No pipe carrying hot water, steam, or other fluid at a surface temperature exceeding 250° F. shall be placed within one inch of any woodwork, pass through a combustible floor, ceiling or partition, unless the pipe is protected by a metal tube one inch larger in diameter than the pipe or with approved pipe covering.

(5) **GAS OR OIL INSTALLATIONS.** (a) *Piping installations.* All gas piping **FP** and all oil piping shall comply with the following standards:

1. National Fuel Gas Code, NFPA No. 54 [ILHR 51.27 (7a)]; or
2. Installation of Oil-Burning Equipment, NFPA No. 31 [ILHR 51.27 (7a)].

(b) *Oil tank installations.* All oil-burning equipment shall be supplied with oil from a supply tank having a capacity of not less than 250 gallons. The fuel oil tank shall be equipped with a fill pipe, vent pipe and oil gauge. The vent pipe and fill pipe shall terminate outside of the building.

History: Cr. Register, December, 1975, No. 240, eff. 1-1-76; r. and recr. Register, December, 1976, No. 252, eff. 1-1-77; am. (1), (3) and (4), Register, December, 1978, No. 276, eff. 1-1-79; am. (5)(a), Register, January, 1980, No. 289, eff. 2-1-80.

Part V—Air Delivery Systems

ILHR 64.31 Duct design. All ducts shall be designed to promote the unrestricted flow of air.

Note: The department will accept air duct velocities designed in accordance with the standards of the ASHRAE Handbook of Fundamentals, published by the American Society of Heating, Refrigerating and Air Conditioning Engineers.

History: Cr. Register, December, 1975, No. 240, eff. 1-1-76.

ILHR 64.32 Duct use. No duct designed for the transmission of air shall be used for any other purpose.

History: Cr. Register, December, 1975, No. 240, eff. 1-1-76.

ILHR 64.33 Underground duct construction and installation. (1) **MATERIALS.** (a) *Tile ducts.* All underground duct systems using cement tile, glazed clay tile and other tile having a composition of cement and mineral shall be waterproof and shall have sufficient strength to prevent failure of duct at the time of installation and while in service. All fittings shall be designed with bell and spigot or slip-joint connections. All joints shall be waterproof.

(b) *Plastic and metal ducts.* Metal, plastic-coated metal ducts, and other approved materials may be used for underground systems if encased in not less than 2 inches of concrete. The ducts shall be waterproof, noncombustible, smooth and of sufficient strength to prevent collapse. The sealing material for fittings and joints shall be approved by the department.

1. Exception. Solid polyvinyl ducts and fittings and polyvinyl chloride (pvc)-clad metallic ducts and fittings need not be encased in concrete

provided the space around the ducts and fittings is backfilled with sand or similar fill material.

(2) **DUCT INSULATION.** All underground ducts shall be insulated as specified in s. ILHR 63.22 (1).

(3) **DUCT DRAINAGE.** Underground ducts shall be provided with drainage to a lower room of the building or to a sump. No duct shall be connected to a sewer.

(4) **DUCT INLETS AND OUTLETS.** A water-tight connection shall be provided where the inlet and outlet risers are connected to underground ducts.

(5) **PIPING.** Nonhazardous piping may be installed in underground ducts if it does not restrict the air flow.

History: Cr. Register, December, 1975, No. 240, eff. 1-1-76; am. (1)(b) and (2), Register, January, 1980, No. 289, eff. 2-1-80; am. (2), Register, December, 1983, No. 336, eff. 1-1-84.

ILHR 64.34 Duct construction. (1) **METAL DUCTS.** All sheet metal ducts, duct liners and fittings shall be constructed in compliance with standards approved by the department.

Note: The department will accept the standards for ducts in the ASHRAE Handbook of Equipment Volume, published by the American Society of Heating, Refrigerating and Air Conditioning Engineers, or as illustrated in the Low Pressure or High Pressure Duct Construction Standards published by the Sheet Metal and Air Conditioning Contractors National Association, Inc.

(2) **COMBUSTIBLE DUCTS.** All ducts or airways of wood or other combustible material shall be lined with sheet metal or other approved noncombustible material unless specifically exempted by this code.

(3) **NONMETALLIC DUCTS.** Coated metal ducts or ducts constructed of other than metal shall conform to the following:

(a) The method for fabricating, installing and supporting ducts shall be approved by the department;

Note: The department accepts Class 1 air ducts tested (Standards for Safety, UL 181) and listed by Underwriters' Laboratories, Inc., and constructed in accordance with fibrous glass duct construction standards published by the Sheet Metal and Air Conditioning Contractors National Association, Inc.

(b) The ducts shall resist puncture, deformation or collapse;

(c) The ducts shall not be used where the air temperature exceeds 250° F, for kitchen or fume exhaust ducts, or to convey solids or corrosive gases;

(d) The ducts shall not pass through required fire-resistive construction.

(4) **SPIRALLY WOUND METAL DUCTS.** Spirally wound metal ducts shall be constructed to provide structural strength equal to rectangular ducts. The metal may be one standard gauge lighter than required for round ducts.

History: Cr. Register, December, 1975, No. 240, eff. 1-1-76; am. (3) (intro.), Register, January, 1980, No. 289, eff. 2-1-80; reprinted to correct error in (3), Register, May, 1980, No. 293; am. (1) and r. (3) (e), Register, August, 1986, No. 356, eff. 1-1-86.

Register, August, 1985, No. 356

ILHR 64.35 Duct connectors. (1) **FLEXIBLE DUCT CONNECTORS.** Flexible duct connectors between duct systems and air outlets or air outlet units shall conform to the following:

- (a) The duct material shall be approved for such use;

Note: Flame-retarded fabric or metal or mineral listed in the Building Materials List, published by Underwriters' Laboratories, Inc., are acceptable.

- (b) The construction shall be approved by the department;
- (c) The connector shall not be subject to deterioration from mildew or moisture; and
- (d) The connector shall not pass through required fire-resistive construction.

(2) **VIBRATION CONTROL.** Vibration isolation connectors at the joint between the duct and fan or heat-producing equipment shall conform to the following:

- (a) Connectors shall be a type approved for such use;

Note: Flame-retarded fabric or metal or mineral listed in the Building Materials List, published by Underwriters' Laboratories, Inc., are acceptable.

- (b) Connectors shall be not more than 10 inches wide; and
- (c) Connectors shall not be used where the air temperature is in excess of 250° F.

History: Cr. Register, December, 1975, No. 240, eff. 1-1-76.

ILHR 64.36 Vertical shafts. Every vertical shaft shall be enclosed with noncombustible material which is fire-resistive rated in accordance with Table 51.03-A.

History: Cr. Register, December, 1975, No. 240, eff. 1-1-76.

ILHR 64.37 Insulation. Heating supply ducts and pipes shall be covered with insulation unless an allowance is made for temperature drop in the system.

Note: Also see s. ILHR 63.22 for additional requirements.

History: Cr. Register, December, 1975, No. 240, eff. 1-1-76; am. Register, December, 1983, No. 336, eff. 1-1-84.

ILHR 64.38 Gravity ventilation ducts. (1) **DESIGN.** Horizontal runs in gravity ventilation ducts connected to siphon-type roof ventilators shall be avoided wherever possible and the maximum practicable inclination shall be provided in all cases. In no case shall the horizontal run exceed 30% of the vertical run unless the room has a mechanical supply of air or the ventilation duct is connected to an exhaust fan.

(2) **SEPARATE DUCTS.** Separate gravity ventilation ducts, from each area of similar occupancy, shall extend to a plenum at the base of a siphon ventilator.

(3) **PLENUMS.** Gravity ventilation ducts, used with mechanical ventilation supply systems, shall not terminate in an attic plenum unless the plenum is airtight, of noncombustible construction, and the attic floor is smooth. All collecting plenums shall be connected to an approved si-

phon-type roof ventilator or to an exhaust fan discharging outside the building.

(4) **DAMPERS.** Dampers are prohibited in gravity ventilation ducts, except atmospheric back-draft dampers are permitted.

History: Cr. Register, December, 1975, No. 240, eff. 1-1-76.

ILHR 64.39 Ventilation discharge. All gravity and mechanical ventilation ducts shall be protected from the weather and shall be so located and constructed as to prevent contamination of an outside air supply. Gravity ventilation ducts shall extend not less than 2 feet above the highest portion of the roof and parapet wall and shall be provided with an approved type of siphon roof ventilator.

History: Cr. Register, December, 1975, No. 240, eff. 1-1-76; am., Register, December, 1981, No. 312, eff. 1-1-82.

ILHR 64.40 Relief vents. (1) **BAROMETRIC RELIEF VENTS PERMITTED.** The use of barometric relief vents is permitted for type (a) and (b) ventilation classifications designated in Table 1. Where barometric relief vents are installed on the roof, the discharge openings shall be not less than 2 feet above the roof.

(2) **BAROMETRIC RELIEF VENTS PROHIBITED.** The use of barometric relief vents is prohibited for type (c), (d) and (e) ventilation classifications designated in Table 1.

History: Cr. Register, December, 1975, No. 240, eff. 1-1-76; am. Register, December, 1976, No. 252, eff. 1-1-77.

ILHR 64.41 Plenums. (1) **GENERAL.** Plenums used for the supply, return or transfer of air shall be of noncombustible construction.

(a) *Exception.* Combustible ceiling materials may be used provided they comply with the following:

1. The ceiling material is made from a base material of metal or mineral;

2. All surfaces of ceiling material possess a flame-spread rating of not over 25 without evidence of continued progressive combustion and with a smoke-developed rating of not higher than 50;

3. The ceiling material is supported by noncombustible material having a melting point above 1400° F. (760° C); and

4. The ceiling material is not subject to deterioration or deformation on long exposure to temperatures of 250° F. (121° C) or under conditions of high humidity, excessive moisture, or mildew.

Note #1: This section permits the use of steel, painted steel bar joists and metal decking, concrete, plaster, and other noncombustible materials and restricts the use of certain combustible materials within air-handling plenums.

Note #2: The requirements for ceiling materials are based upon the National Fire Protection Association (NFPA) standard 90A, section 2-2.1.3.

(2) **DUCTWORK WITHIN THE PLENUM.** Ducts within the plenum shall be constructed of metal in accordance with s. ILHR 64.34 (1) or approved nonmetallic materials in accordance with s. ILHR 64.34 (3).

Register, August, 1985, No. 356

(3) **DUCT CONNECTORS.** Duct connectors shall comply with the requirements of s. ILHR 64.35.

Note: Flame-retardant fabric or metal or mineral listed in the Building Materials List, published by Underwriters' Laboratories, Inc., are acceptable.

(4) **INSULATING MATERIALS WITHIN THE PLENUM.** (a) *Duct and pipe insulation.* Duct and pipe insulation, including coverings, linings, tapes and core materials, shall have a flame-spread rating of not over 25 without evidence of continued progressive combustion, and a smoke-developed rating no higher than 50 when tested according to ASTM E-84 standard tests. If coverings and linings are to be applied with adhesives, they shall be tested as applied with such adhesives, or the adhesives used shall have a flame-spread rating not over 25 and a smoke-developed rating no higher than 50 when in the final dry state.

(b) *Building envelope insulation.* Building envelope insulation within the plenum space shall have a flame-spread rating of 25 or less and a smoke-developed rating of 50 or less when tested according to ASTM E-84 test standards. The use of foam plastics, satisfying the requirements of s. ILHR 51.06, for envelope insulation is permitted provided the foam plastic is protected by a thermal barrier as specified in s. ILHR 51.06 (3).

(5) **HAZARDOUS PIPING.** The installation of hazardous piping as defined in s. ILHR 51.01 (102) is prohibited in the plenum space.

(6) **OPENINGS.** Openings into the plenum that would affect the fire-resistive rating of the structural component or system are prohibited.

(7) **WIRING AND CABLES.** Electric wiring, including low-voltage wiring, and telephone cables within the plenum space shall be installed according to the Wisconsin State Electrical Code, Vol. 2, ch. ILHR 16.

(8) **PLUMBING.** Plumbing within the plenum shall be of noncombustible material.

(a) *Exception.* Plastic plumbing pipe and fittings may be used provided the plastic material is of the self-extinguishing type with an average extent of burn not greater than 10 mm and an average time of burn not greater than 20 seconds when tested according to ASTM D-635. The plastic material shall be wrapped with at least one inch of inorganic insulation or enclosed with ½ inch type X gypsum wallboard.

(9) **CONTROL TUBING.** Plastic control tubing shall have an average extent of burn not greater than 10 mm and an average time of burn not greater than 20 seconds when tested according to ASTM D-635.

(10) **SMOKE DETECTION.** (a) *New construction.* Air-handling plenums which contain ductwork, duct connectors, insulation, plumbing or control tubing which do not meet the requirements of subs. (2) to (4), (8) and (9), respectively, shall be provided with an approved smoke detection system capable of stopping the air flow in and from the plenum and giving an audible alarm in the occupied area when activated.

(b) *Existing construction.* When existing plenum construction contains combustible insulation, wiring, plumbing or control tubing, and is altered or added to according to s. ILHR 50.03 (1) or (2), the entire plenum space, new and existing, shall be provided with a smoke detection system according to sub. (10) (a).

1. Exception. Building additions separated from existing construction by one-hour noncombustible construction need not be provided with a smoke detection system provided the plenum is constructed according to subs. (1) to (8).

History: Cr. Register, December, 1975, No. 240, eff. 1-1-76; am. Register, December, 1976, No. 252, eff. 1-1-77; r. and recr. Register, December, 1978, No. 276, eff. 1-1-79; r. and recr. Register, January, 1980, No. 289, eff. 2-1-80; am. (1) (intro.), (6) and (10), Register, December, 1981, No. 312, eff. 1-1-82; am. (4) (b), Register, August, 1985, No. 356, eff. 1-1-86.

FP ILHR 64.42 Fire dampers and fire curtain doors. (1) **REQUIRED FIRE DAMPERS AND FIRE CURTAIN DOORS.** All heating and ventilating ducts, except underground ducts used with counterflow or downflow heating equipment, which terminate at or pierce code-required, hourly rated wall, floor or floor-ceiling assemblies as specified in Table 51.03-A and rated enclosures shall be protected as follows:

(a) One-hour rated assemblies and enclosures shall be protected with 1½ hour rated fire dampers where continuous steel ductwork to the air handling device is not provided for at least 6 feet on either side of the assembly or enclosure;

(b) Two-hour rated assemblies and enclosures shall be protected with 1½ hour rated fire dampers; or

(c) Three-hour and 4-hour rated assemblies and enclosures shall be protected with 3-hour "A" label fire curtain doors.

(2) **EXCEPTIONS.** Exceptions to sub. (1) are:

(a) Any assembly, such as a floor-ceiling assembly, that has been certified for use without fire dampers and approved by a nationally recognized testing laboratory;

(b) Metal ducts which do not exceed a maximum area of 20 square inches; or

(c) Interior bearing walls and partitions if unrated openings are permitted by other sections of chs. ILHR 50-64.

(3) **SERVICING FIRE DAMPERS.** Access panels shall be provided next to fire dampers and fire curtain doors to permit viewing and servicing.

Note #1: The department will accept fire dampers and fire curtain doors listed by Underwriters' Laboratories, Inc. or an approved nationally recognized testing laboratory. The dampers must be installed in the vertical or horizontal position that the dampers were designed and tested for. The department will also accept fire damper and fire curtain door installations recommended in publications of the Sheet Metal, Air Conditioning Contractors National Association, Inc., and the National Fire Protection Association bulletins No. 80 and 90A.

Note #2: Fire dampers classified by Underwriters' Laboratories as 1-½ hour rated assemblies are of single blade, multi-blade and curtain types. Fire curtain doors classified by Underwriters' Laboratories as time rated (3 hour) and labeled (A) are of the curtain-blade type.

Note #3: See s. ILHR 64.67 for fire damper requirements in kitchen exhaust systems.

History: Cr. Register, December, 1975, No. 240, eff. 1-1-76; r. (1) (a), renum. (1) (b) and (c) to be (1) (a) and (b), Register, December, 1976, No. 252, eff. 1-1-77; am. (2) (c), Register, December, 1977, No. 264, eff. 1-1-78; cr. (2) (d), Register, December, 1978, No. 276, eff. 1-1-79; am. (1) and (2), Register, December, 1981, No. 312, eff. 1-1-82; am. (1) (intro.) and (a), Register, December, 1983, No. 336, eff. 1-1-84.

ILHR 64.43 Dampers and damper controls. (1) **VOLUME DAMPERS AND DEFLECTORS.** Volume dampers, splitters and deflectors shall be provided Register, August, 1985, No. 356

in all ducts to permit accurate balancing of the system. The dampers, splitters and deflectors shall be adjusted to satisfy the heating and ventilating requirements of the conditioned space and locked in place.

(2) **AIR GRILLES.** All air supply outlets and returns shall be equipped with grilles or devices which will provide a uniform distribution of air.

History: Cr. Register, December, 1975, No. 240, eff. 1-1-76.

ILHR 64.44 Fans and blowers. (1) **TYPE AND CAPACITY.** Fans and blowers shall be of a type and size that will satisfy the design conditions of the heating and ventilating system. Fans and blowers shall be rated in accordance with an approved test procedure.

Note: The department accepts certified ratings listed by the Air Moving and Conditioning Association, Inc.

(2) **QUIET OPERATION.** The sound generated by various fans and blowers shall not be objectionable.

History: Cr. Register, December, 1975, No. 240, eff. 1-1-76.

Part VI—Chimneys, Gas Vents, Mechanical Draft and Venting Devices

ILHR 64.45 Chimneys, smoke stacks, gas vents, mechanical draft and venting devices. (1) **GENERAL REQUIREMENTS.** Heating equipment using solid, liquid or gas fuels shall be vented to the outside, except as permitted in s. ILHR 64.21. A natural draft chimney or other venting device shall have the height and area to remove the products of combustion. Chimneys, smoke stacks, gas vents, mechanical draft and venting devices shall comply with the requirements of NFPA No. 211 [s. ILHR 51.27 (7a)], Chimneys, Fireplaces and Vents. **FP**

(2) **NONCOMBUSTIBLE SUPPORTS.** All chimneys or gas vents shall be supported from noncombustible construction unless otherwise approved.

(3) **TERMINATION.** (a) *Gravity type.* 1. All chimneys or smokestacks depending on a gravity principle for the removal of the products of combustion shall extend at least 3 feet above the highest point where the chimneys or smokestacks pass through the roof of the building, and at least 2 feet higher than any ridge, peak or wall within 10 feet of the chimney or smokestack.

2. Type "B", "BW" and "L" vents and single wall vent pipes depending on a gravity principle for the removal of the products of combustion shall extend at least 2 feet above the highest point where the vents or pipes pass through the roof of the building, and at least 2 feet higher than any ridge, peak or wall within 10 feet of the vent or pipe.

(b) *Mechanical type.* The height and cross-sectional area may be reduced for chimneys employing a mechanical draft system of either forced or induced draft when approved by the department.

History: Cr. Register, December, 1975, No. 240, eff. 1-1-76; am. (1) and (3)(a), Register, January, 1980, No. 289, eff. 2-1-80.

ILHR 64.46 Masonry chimneys. The design and construction of the chimney shall conform to the provisions of this section. **FP**

Register, August, 1985, No. 356

(1) **MATERIALS.** The walls shall be built of brick or other approved fire-resistant material. No chimney shall rest upon a flooring of wood nor shall any wood be built into or in contact with any chimney. Combustible headers, beams, joists and studs shall be located at least 2 inches from the outside face of a chimney. The foundation shall be designed and built in conformity with the requirements for foundations for buildings. In no case shall a chimney be corbeled out more than 6 inches from the wall and in every case the corbeling shall consist of at least 5 courses of brick.

(2) **FLUE SIZE.** Every masonry chimney shall have walls at least 8 inches in solid thickness, except that in a chimney with a flue not larger than 260 square inches where a fire clay or other suitable refractory clay flue lining is used for the full height of the chimney the walls shall not be less than 4 inches in solid thickness. No smoke flue shall have a cross-sectional area less than 64 square inches. Flue linings 7 inches by 7 inches inside, or 8 inches in diameter inside, may be used.

(3) **FLUE LININGS.** All flue linings shall be capable of withstanding reasonably high temperatures and flue gases and shall have a softening point not lower than 1800° F. Flue linings shall be not less than ¾ inch in thickness and shall be built in as outer walls of the chimney are constructed. Flue linings shall start from a point not less than 8 inches below the bottom of the smoke pipe intake and shall be continuous to a point not less than 4 inches above the enclosing walls.

(4) **SMOKE PIPE CONNECTION.** If there is more than one smoke pipe connected to a flue, the connections shall be at different levels. Two or more heating units, or appliances, may be connected to a common smoke pipe, or breeching, if joined by Y fittings as close as practicable to the flue. In all such cases, the size of the breeching and the flue shall be sufficient to accommodate the total volume of flue gases.

(5) **CLEAN-OUT OPENING.** Every chimney shall be provided with a clean-out opening at the base. Such openings shall be equipped with metal doors and frames arranged to remain closed when not in use.

(6) **WIND PRESSURE.** Every chimney shall be designed to withstand wind pressures in accordance with the requirements of s. ILHR 53.12.

History: Cr. Register, December, 1975, No. 240, eff. 1-1-76; am. (1), Register, January, 1980, No. 289, eff. 2-1-80.

FP ILHR 64.47 Metal smokestacks. (1) **SMOKESTACKS IN EXCESS OF 30 FEET.** The thickness of the metal walls shall be at least 3/16 inch for smokestack heights up to 40 feet and ¼ inch for greater heights. Stacks used for manufacturing, high-pressure boilers, furnaces or other similar heating or manufacturing appliances shall be lined with firebrick, or equivalent, for a distance of not less than 25 feet from the place where the smoke pipe enters and shall be protected on the outside up to and through the roof of the building with 8 inches of masonry, or a metal shield which provides an 8-inch ventilated air space between such shield and the stack. All stacks shall be properly guyed if the height of the stack exceeds 15 times its least diameter.

(a) *Exception.* Public utility or industrial power plants are exempted from the protection requirements of this paragraph if they are of type 1 or 2 construction.

Register, August, 1985, No. 356

(2) **SMOKESTACKS LESS THAN 30 FEET.** Smokestacks less than 30 feet high may be constructed of not less than No. 10 U.S. gauge steel, with either welded or riveted joints, and may be mounted directly upon masonry chimneys or foundations or upon industrial heating or power boilers provided all of which are designed to support the stack load. A clearance of not less than 6 inches shall be maintained at all times around such smokestack and any combustible material within 12 inches of such smokestack shall be protected by ¼ inch of asbestos covered by sheet metal.

History: Cr. Register, December, 1975, No. 240, eff. 1-1-76; am. (1) (intro.), Register, December, 1978, No. 276, eff. 1-1-79.

ILHR 64.48 Factory-built chimneys and gas vents. (1) **GENERAL.** Factory-built chimneys and gas vents shall be of an approved type. **FP**

(2) **TYPES OF APPROVED CHIMNEYS AND GAS VENTS.** (a) *Residential type and building heating appliance.* An approved "residential type and building heating appliance" chimney or "building heating appliance" chimney may be used with solid-, liquid- or gas-fired heating appliances where the flue gas temperature does not exceed 1000° F. continuously, and does not exceed 1400° F. for infrequent brief periods of forced firing.

(b) *Type "B".* An approved type "B" gas vent may be used with gas-fired appliances where the flue gas temperature does not exceed 550° F. at the outlet of the draft hood.

(c) *Type "BW".* An approved type "BW" gas vent may be used with a vented recessed wall heater.

(d) *Single wall vent pipe.* An approved single wall vent pipe may be used with gas-fired, low-heat appliances (low-pressure boilers, furnaces and space heaters). The vent shall be not less than No. 20 standard gauge galvanized iron, No. 24 Brown and Sharpe gauge sheet copper, or other approved corrosion-resistant material. The installation shall conform to the requirements of s. ILHR 64.50.

(e) *Type "L".* An approved type "L" vent may be used with oil-fired appliances listed as suitable by a recognized agency and with gas-fired appliances approved for type "B" vents.

(f) *Equipment listed with venting system.* Venting systems included with the listing of the heating appliance may be used subject to the requirements and limitations of the listing.

Note: The department recognizes, as approved, chimneys designated as "residential type", "building heating appliance", "B", "BW" and "L" types listed by Underwriters' Laboratories, Inc.

History: Cr. Register, December, 1975, No. 240, eff. 1-1-76; r. and recr., Register, December, 1978, No. 276, eff. 1-1-79; am. (2)(a) and (d), Register, December, 1981, No. 312, eff. 1-1-82; cr. (2) (f), Register, December, 1983, No. 336, eff. 1-1-84.

ILHR 64.49 Gas vents. All gas ranges (except those designed as unvented), water heaters and other gas-fired equipment shall be provided with vent pipes conforming to the requirements for gas vents as specified in s. ILHR 64.48 and for connectors as specified in s. ILHR 64.50. Commercial kitchen appliances including but not limited to ranges, ovens, **FP**

booster heaters and similar equipment may be vented into the kitchen hood exhaust system.

History: Cr. Register, December, 1975, No. 240, eff. 1-1-76; am. Register, December, 1978, No. 276, eff. 1-1-79; am. Register, January, 1980, No. 289, eff. 2-1-80; renum. from ILHR 64.50 and am., Register, December, 1981, No. 312, eff. 1-1-82.

FP ILHR 64.50 Chimney and vent connectors. (1) **CONSTRUCTION AND INSTALLATION.** The construction and installation of chimney connectors shall conform with the following requirements:

(a) *Concealed space.* No chimney connector shall pass through any outside window, door or combustible outside wall, nor be concealed in any closet, attic or similar space;

(b) *Combustible partitions and walls.* Connectors for appliances shall not pass through interior walls or partitions constructed of combustible material unless they are guarded at the point of passage by:

1. Metal ventilated thimbles not less than 12 inches larger in diameter than the connector, or

2. Metal or burned fireclay thimbles built in brickwork or other approved fireproofing materials extending not less than 8 inches beyond all sides of the thimble;

(c) *Distance from materials.* Connectors shall be installed with clearance to combustibles specified in par. (b) or NFPA Standard 211;

(d) *Multiple appliance venting.* Two or more appliances using the same type of fuel may be connected to a common gravity-type chimney or vent, provided the appliances are equipped with primary safety controls and listed shutoff devices and comply with the following requirements:

1. The appliances shall be located in the same story, except for engineered venting systems,

2. The appliances shall be joined at a manifold or Y-type fitting as close to the chimney or vent as possible, unless the connector from each appliance enters a separate chimney or vent inlet and the inlets are offset at least 12 inches vertically or are at right angles to each other,

3. The connector and chimney or vent shall be sized to accommodate the total volume of flue gases. For gas-burning appliances, the venting area shall be at least equal to the size of the largest vent connector plus at least 50% of the area of the other vent connectors, or

4. A chimney serving a fireplace or other piece of solid-fuel equipment shall not be used to vent any other appliance;

(e) *Pitch and length.* Chimney or vent connectors shall have no more than two 45° offsets with the vertical. The horizontal length shall not exceed 75% of the total vertical height of the total venting system measured from the appliance outlet. Chimney or vent connectors shall be pitched up at least ¼ inch per foot from the appliance outlet collar to the chimney or vent inlet;

(f) *Dampers.* A manual cast iron or equivalent damper to control the draft shall be provided in the chimney connector next to solid-fuel fired equipment. Manually operated dampers shall be prohibited in chimney or vent connectors of all other appliances. When used, listed automati-

cally operated dampers interlocked with the heating appliance shall be installed in accordance with the approved listing; and

(g) *Materials and thickness.* 1. Except as specified in subd. 2., chimney or vent connectors shall be listed or conform to the type of material and thickness indicated in Table 64.50 or equivalent.

2. 'Exception'. Connectors serving listed residential-type gas appliances shall be not less than .016 inch galvanized steel.

TABLE 64.50

MINIMUM CHIMNEY CONNECTOR METAL THICKNESS

Galvanized Steel		
Diameter of Connector	Min. thickness (inch)	Gauge
Less than 6 inches	.019	26
6 inches to less than 10 inches	.024	24
10 inches to 13 inches	.030	22
14 inches to 16 inches	.036	20
Greater than 16 inches	.058	16

History: Cr. Register, December, 1981, No. 312, eff. 1-1-82; am. (1) (c) and (g) 2., Register, August, 1985, No. 356, eff. 1-1-86.

Part VII—Equipment Location, Protection, Maintenance and Operation

ILHR 64.51 Guarding and fire protection. (1) **GUARDING OF EQUIPMENT.** Heating and ventilating equipment in gymnasiums, playrooms and similarly occupied areas shall be fully recessed and protected, or located not less than 7 feet above the floor. Heating and ventilating equipment shall not block any part of the required aisles, passageways and corridors.

(2) **GUARDING OF SURFACES.** Equipment located in occupied areas and installed less than 7 feet above the floor shall be guarded to prevent contact with surfaces that are likely to cause lacerations.

(3) **GUARDING OF MECHANICAL APPARATUS.** All mechanical apparatus shall be guarded to comply with the requirements of chs. Ind 1000-2000—Safety and Health Code.

(4) **FIRE PROTECTION.** (a) 1. Heat-producing appliances and their chimney or vent connectors shall be installed with clearances to combustible material as specified in NFPA Manual No. 211 unless listed for installation at other clearances. **FP**

2. Clearance to combustible materials shall be as specified in NFPA Standard No. 211 or as specified by a nationally recommended testing laboratory, whichever is greater.

(b) Clearances shall be measured from the outer surface of the appliance or connector to the combustible material, disregarding any intervening protection applied to the combustible material.

(c) Appliances shall not be installed in alcoves or closets unless approved for such installations.

History: Cr. Register, December, 1975, No. 240, eff. 1-1-76; am. (2), Register, December, 1976, No. 252, eff. 1-1-77; am. (2), Register, January, 1980, No. 289, eff. 2-1-80; am. (4), Register, December, 1981, No. 312, eff. 1-1-82; am. (4) and r. tables 64.51 A to D, Register, August, 1985, No. 356, eff. 1-1-86.

FP ILHR 64.52 Maintenance and operation. (1) **MAINTENANCE.** All heating, ventilating, exhaust and air conditioning systems shall be maintained in good working order and shall be kept clean and sanitary. Chimneys or vents and connectors serving solid-fuel burning appliances shall be cleaned and inspected for damage annually. Chimneys and vents, which have been subjected to a chimney fire, shall not be reused until inspected and approved by the department or authorized deputy.

(2) **OPERATION.** All heating, ventilating and exhaust systems shall be operated to satisfy the requirements of this chapter during periods the building is occupied.

(3) **INSTRUCTIONS.** The designer or installer shall provide the owner with written instructions for the operation and maintenance of the system and equipment.

History: Cr. Register, December, 1975, No. 240, eff. 1-1-76; am. (1), Register, December, 1981, No. 312, eff. 1-1-82.

ILHR 64.53 Final test required. The designer, installer or recognized balancing agency shall be responsible for the testing and balancing of every heating, ventilating and air conditioning system.

History: Cr. Register, December, 1975, No. 240, eff. 1-1-76.

Part VIII—Occupancy Requirements

ILHR 64.54 Factories, office and mercantile buildings. (1) **SCOPE.** This classification shall include all places of employment, mercantile buildings, retail establishments where goods and commodities are bought and sold, and places where not more than 100 persons assemble for worship, recreation, entertainment or dining purposes.

Note: For mall corridors of enclosed mall shopping centers, see s. ILHR 64.05, Table 1.

(2) **VENTILATION.** The air movement, supply and distribution for all occupancies in this class shall conform to the requirements of s. ILHR 64.05, Table 1, except that natural ventilation or mechanical ventilation need not be provided in warehouses and cold storage buildings.

(3) **INDUSTRIAL EXHAUST SYSTEM.** (a) *Contaminants.* Industrial exhaust systems shall be installed and operated to remove harmful contaminants in conformance with chs. Ind 1000-2000—Safety and Health Code.

(b) *Makeup air.* A volume of outside air shall be supplied to replace the air exhausted if the total volume of air exhausted exceeds one air change per hour. The quantity of makeup air shall equal at least 90% of the air exhausted.

(c) *Connections.* Connections between industrial exhaust systems that convey different materials, the combination of which may produce explosive, heat-generating, corrosive, toxic, or otherwise dangerous mixtures, shall be prohibited.

Register, August, 1985, No. 356

(4) **LOCKER ROOMS.** Locker rooms used in places of industrial employment shall be provided with outside air. See s. ILHR 64.05, Table 1.

Note: Exhaust air from locker rooms may be directed through the adjoining toilet room or shower room.

(5) **FIRST AID REST ROOMS IN PLACES OF EMPLOYMENT.** Ventilation shall be provided for all areas of this class to conform to the requirements of s. ILHR 64.05, Table 1.

History: Cr. Register, December, 1975, No. 240, eff. 1-1-76.

ILHR 64.55 Theaters and places of assembly. (1) **SCOPE.** This classification shall include auditoriums, arenas, armories, assembly halls, banquet halls, billiard rooms, bowling alleys, cafeterias, club rooms, dance halls, dining rooms, gymnasiums, lecture halls, lodge halls, playrooms, restaurants, school auditoriums, Sunday schools and places of worship, funeral home chapels, parochial schools, convents, indoor skating rinks, and theaters which accommodate more than 100 persons for entertainment, recreation, worship, or dining purposes.

Note: For areas that will accommodate less than 100 persons, see s. ILHR 64.54.

(2) **VENTILATION.** The air movement, supply and distribution for all occupancies under this classification shall conform to the requirements of s. ILHR 64.05, Table 1.

(3) **ALTERNATE SERVICE AND CAPACITY.** Heating and ventilating systems installed in places of worship, Sunday schools, so-called community buildings and lodge halls may be arranged for selective delivery of the entire service to either the first floor area or to the basement floor area provided these areas are not used simultaneously.

(4) **STAGES.** The stage in any theater or assembly hall, for which a fire curtain is required, shall be supplied with sufficient air or other means to equalize the pressure to avoid deflecting the curtain.

History: Cr. Register, December, 1975, No. 240, eff. 1-1-76.

ILHR 64.56 Schools and other places of instruction. (1) **SCOPE.** This classification shall apply to all public and private schools, colleges, universities, academies, seminaries, libraries, museums, art galleries, all places used for vocational instruction and research such as laboratories, shops, science rooms, and all parts of buildings used for instructional purposes.

(2) **VENTILATION.** The air movement, supply and distribution for all occupancies under this classification shall conform to the requirements of s. ILHR 64.05, Table 1. For corridors provided with lockers, the air movement shall be not less than 10 cubic feet per minute per lineal foot of corridor. This air supply shall be accomplished by means of air inlets admitting air from adjacent classrooms or by a direct tempered air supply.

Note: This rule does not apply to corridors furnished with coat hooks.

(3) **EXHAUST SYSTEMS AND HEAT RECOVERY.** (a) An exhaust system, as specified in s. ILHR 64.54 (3), shall be provided for all equipment and processes that create dust, fumes, vapors and gases injurious to health.

(b) Exhaust systems whose operation is more than 3600 hours per year shall be equipped with heat recovery devices to reduce the energy consumption in the building.

1. Exception. a. Systems exhausting explosive materials, such as perchloric acid need not be so equipped.

b. Fan systems exhausting 250 CFM or less need not be so equipped.

History: Cr. Register, December, 1975, No. 240, eff. 1-1-76; am. (3), Register, December, 1976, No. 252, eff. 1-1-77.; am. (3), Register, December, 1981, No. 312, eff. 1-1-82.

ILHR 64.57 Health care facilities. (1) **SCOPE.** The rules of this section apply to hospitals, nursing homes and outpatient surgical facilities where medical services are provided.

(2) **GENERAL.** (a) The heating, ventilating and air conditioning systems of all occupancies within the scope of this section shall be designed, operated and maintained as specified in sections 2, 7.29 A. to D., 8.12 A. to C., 9.2 L., 9.4 I., 9.5 M. and 9.6 J., depending upon the occupancy, of the Guidelines for Construction and Equipment for Hospitals and Medical Facilities, DHHS Publication No. (HRS-M-HF) 84-1.

(b) The heating, ventilating and air conditioning systems shall also be designed, operated and maintained as specified in the applicable sections of the following standards as referenced in DHHS Publication No. (HRS-M-HF) 84-1.:

1. Installation of Air Conditioning and Ventilating Systems, NFPA No. 90A;

2. ASHRAE Handbook of Fundamentals; and

3. Methods of Testing Air Cleaning Devices Used in General Ventilation for Removing Particulate Matter, ASHRAE Standard No. 52.

(3) **APPLICATION OF RULES.** Where other sections of ch. ILHR 64 specify different requirements than those contained in this section, the requirements specified in this section shall govern.

History: Cr. Register, December, 1975, No. 240, eff. 1-1-76; r. (2) (d), Register, January, 1980, No. 289, eff. 2-1-80; r. and recr., Register, February, 1982, No. 314, eff. 3-1-82; r. and recr. (2), r. (3), renum. (4) to be (3), Register, August, 1985, No. 356, eff. 1-1-86.

ILHR 64.58 Penal institutions and places of detention. (1) **SCOPE.** This classification shall include corridors and areas of compulsory occupancy in penal institutions, mental hospitals and other places of detention.

(2) **VENTILATION.** The air movement, supply and distribution for all areas of this class shall conform to the requirements of s. ILHR 64.05, Table 1.

(3) **OVERNIGHT LOCK-UPS.** Where cells are provided for not more than 6 occupants for the purpose of overnight detention only, exhaust ventilation shall be provided on the basis of 6 air changes per hour for the occupied area.

History: Cr. Register, December, 1975, No.240, eff. 1-1-76; am. (2), Register, December, 1981, No. 312, eff. 1-1-82.

ILHR 64.59 Residential occupancies. (1) **SCOPE.** This classification shall include all apartments, row houses, rooming houses, hotels, motels, dormitories, and all other places of abode.

Note: See s. ILHR 51.01 (102a) for definition of "place of abode."

Register, August, 1985, No. 356

(2) **VENTILATION.** The air movement, supply and distribution for all areas of this class shall conform to the requirements of s. ILHR 64.05, Table 1.

(a) *Exception.* For motel or hotel sleeping rooms without openable outside windows and facing naturally lighted pool or recreation areas, see ss. ILHR 52.02 (1) (b) and 57.13 (2).

(3) **RETURN AIR DUCTS.** Unlined wood joists and stud spaces will be permitted to be used as return air ducts in individual living units provided with individual heating and ventilating systems.

History: Cr. Register, December, 1975, No. 240, eff. 1-1-76; am. (3), Register, December, 1976, No. 262, eff. 1-1-77; cr. (2) (a), Register, May, 1980, No. 293, eff. 6-1-80.

ILHR 64.60 Day care facilities. (1) **SCOPE.** This classification shall include all public and private day care centers accommodating more than 4 children, including all buildings or parts of buildings used as child day care facilities.

(2) **VENTILATION.** The air movement, supply and distribution for all areas of this class shall conform to the requirements of s. ILHR 64.05, Table 1.

History: Cr. Register, December, 1975, No. 240, eff. 1-1-76.

ILHR 64.61 Repair areas. (1) **SCOPE.** This classification includes all areas where motor-driven vehicles are repaired involving the fuel system components or requiring the operation of the internal combustion engine.

(2) **VENTILATION.** The air movement, supply and distribution shall be provided in accordance with the requirements of s. ILHR 64.05, Table 1. The exhaust air shall be drawn from not more than 18 inches above the floor. FP

(3) **TAIL PIPE EXHAUST.** (a) *Mechanical exhaust system.* A mechanical exhaust system shall be provided in the repair area to remove the exhaust fumes from internal combustion engines. The duct system shall be designed with sufficient outlets to accommodate the total number of vehicles in the repair area. A flexible hose, equipped with a device for connecting it to the exhaust pipe of the vehicle and to the exhaust system, shall be provided. Each outlet shall be provided with a shut-off valve that can be closed when not in use. The blower capacity shall be sufficient to exhaust a volume of air not less than 100 cubic feet per minute for each opening.

(b) *Nonmechanical exhaust.* A noncombustible flexible tube or hose not more than 10 feet long, connected to the engine exhaust (tail pipe) and terminating outside the building, may be used in lieu of the requirements stated in par. (a).

Note: The requirements stated in sub. (2) need not be increased when satisfying requirements of either sub. (3) (a) or (b). Also see chs. Ind 1000-2000—Safety and Health Code.

(4) **MISCELLANEOUS REPAIR AREAS.** Areas involved in the servicing of small internal combustion engines such as lawnmowers, snowmobiles, chainsaws, cycles, boat engines, and similar types of engines, and battery charging areas, shall be provided with at least 3/4 cubic foot per minute of outside air per square foot of enclosed service floor area and an

Register, August, 1985, No. 356

equivalent exhaust. Exhaust from battery charging areas shall be from the top of the area.

(5) **CONTAMINANTS.** If the provisions of this section do not provide sufficient ventilation to meet the standards for threshold limit values covered in chs. Ind 1000-2000—Safety and Health Code, the additional exhaust requirements with an equivalent volume of outside air shall be provided to satisfy the requirements found in chs. Ind 1000-2000.

History: Cr. Register, December, 1975, No. 240, eff. 1-1-76; am. (4), Register, December, 1978, No. 276, eff. 1-1-79; am. (1), Register, December, 1983, No. 336, eff. 1-1-84.

ILHR 64.62 Vehicle service buildings. (1) **APPLICATION.** (a) This section applies to liquid fuel dispensing stations and facilities where vehicles can be driven into the building for washing, greasing, oil change, tire replacement, body repair, and similar operations.

(b) The exhaust air shall be drawn from not more than 18 inches above the floor.

FP (2) VENTILATION. (a) Air movement, supply, distribution and exhaust shall be provided as specified in s. ILHR 64.05, Table 1.

(b) Buildings or portions of buildings having a capacity of and used exclusively for washing 2 or more vehicles simultaneously shall be exhausted at not less than ½ cubic foot per minute per square foot of floor area based on that portion of the floor located between the termination of the conveyor system and the vehicle exit door. A supply of makeup air is not required for this exhaust.

History: Cr. Register, December, 1975, No. 240, eff. 1-1-76; am. (2)(b) (intro.), Register, January, 1980, No. 289, eff. 2-1-80; r. and recr. Register, August, 1985, No. 356, eff. 1-1-86.

ILHR 64.63 Garages. (1) **SCOPE.** This classification includes all buildings, or parts of buildings, where motor-driven vehicles are stored.

FP (2) VENTILATION. The air movement, supply and distribution shall be provided in accordance with the requirements of s. ILHR 64.05, Table 1. Live storage areas shall be provided with exhaust air drawn from a height not more than 18 inches above the floor unless the following requirements are satisfied:

(a) The floor is located at or above grade; and

(b) A permanent open-wall area of at least 30% of the total wall area is provided. The openings shall be distributed to permit circulation of air throughout the storage area.

Note: The department will permit the use of a mechanical exhaust system in conjunction with openings in the exterior walls to provide the ventilation required by Table 1.

(3) **CONTAMINANTS.** If the provisions of this section do not provide sufficient ventilation to meet the standards for threshold limit values covered in chs. Ind 1000-2000—Safety and Health Code, the additional exhaust requirements with an equivalent volume of outside air shall be provided to satisfy the requirements found in chs. Ind 1000-2000.

History: Cr. Register, December, 1975, No. 240, eff. 1-1-76.

ILHR 64.64 Vehicle showrooms. (1) **SCOPE.** This classification includes all vehicle showrooms with offices and occupancies unless designed as part of the vehicle garage adjacent to repair or vehicle storage areas
Register, August, 1985, No. 356

where all vehicles displayed in the showroom are without batteries and fuel tanks are empty and free of fumes.

Note: A live storage area is any area used for storage of fire trucks, tractors, automobiles, trucks, and similar self-propelled vehicles which are driven in and out of the storage area under their own power; it does not include areas where vehicles and equipment are stored for seasonal periods, or areas where vehicles are displayed without batteries and where the gasoline tanks of the vehicles are empty and free of fumes.

(2) **VENTILATION.** The air movement, supply and distribution shall be provided in accordance with the requirements of s. ILHR 64.05, Table 1.

(a) *Separate ventilating system.* A separate ventilating system shall be provided for showrooms or offices where such occupancies are adjacent to repair or live storage areas.

Note: Ventilation is not required if an openable area is provided to conform with the requirements of s. ILHR 64.07.

(b) *Recirculation.* Air shall not be recirculated from any repair, live storage or service area unless the total volume of air in circulation is in excess of the ventilation required. Excess air may be recirculated.

(c) *Contaminants.* If the provisions of this section do not provide sufficient ventilation to meet the standards for threshold limit values covered in chs. Ind 1000-2000—Safety and Health Code, the additional exhaust requirements with an equivalent volume of outside air shall be provided to satisfy the requirements found in chs. Ind 1000-2000.

History: Cr. Register, December, 1975, No. 240, eff. 1-1-76; am. (1), Register, December, 1983, No. 336, eff. 1-1-84.

ILHR 64.65 General sanitation and service areas. (1) **SCOPE.** This classification shall include toilet rooms, locker rooms, shower rooms and janitor closets.

Note #1: A janitor closet is a service closet with one or more plumbing fixtures.

Note #2: For exhaust ventilation requirements in hospital service areas, see s. ILHR 64.57.

Note #3: For exhaust ventilation requirements in places of employment, see s. ILHR 64.54.

Note #4: The use of wall registers within 4 inches of the floor, baseboard registers, and floor registers is prohibited in these areas. (See s. ILHR 52.57, Note.)

Note #5: The rules of this section are not intended to preclude the use of energy recovery wheels, plate type heat exchangers or similar energy recovery equipment.

(2) **EXHAUST VENTILATING SYSTEMS.** Exhaust ventilating systems serving this class of occupancy may be combined with other exhaust services provided the combined system:

(a) Does not allow recirculation; and

(b) Does not include grease hood exhaust, radioactive exhaust, fume hood exhaust, exhaust required by chs. Ind 1000-2000, exhaust that requires electrical grounding, or exhaust that requires spark resistant fan construction.

(3) **VENTILATION.** The air movement, supply and distribution shall be provided in accordance with the requirements of s. ILHR 64.05, Table 1.

(a) *Exhaust ventilation.* Exhaust ventilation shall be provided for all areas of this class unless otherwise exempted. The volume of air exhausted shall be provided at a rate of not less than 2 cubic feet per minute

per square foot of floor area, or 60 cubic feet per minute per fixture (water closets and urinals). Mechanical exhaust ventilation shall be installed in toilet rooms having more than one fixture (water closets and urinals). The effectiveness of the exhaust shall be greater than the supply.

(b) *Natural ventilation.* Exhaust ventilation is not required from toilet rooms having one water closet or one urinal, or from janitor closets having one service sink or receptor, provided the room has an outside window of at least 4 square feet with at least 2 square feet that is openable.

1. Exception. Mechanical exhaust ventilation may be omitted from toilet rooms or bathrooms having one water closet or urinal except in taverns and restaurants, or from janitor closets having one service sink or receptor, where an approved ductless air circulating and treatment device is provided.

(c) *Locker, shower and toilet room ventilation.* Adjoining locker, shower and toilet rooms shall be exhausted at the rate of 2 cubic feet per minute per square foot of area, based on the floor area of the largest space. The rooms shall be provided with tempered makeup air supplied directly from the outside or transferred from other areas of the building in accordance with the requirements of s. ILHR 64.18. A negative pressure relationship shall be maintained in the shower and toilet rooms with respect to the locker room.

History: Cr. Register, December, 1975, No. 240, eff. 1-1-76; am. (1), cr. (3) (c) and r. (4), Register, December, 1976, No. 252, eff. 1-1-77; cr. (3) (b) 1, Register, December, 1977, No. 264, eff. 1-1-78; am. (3) (b) 1., Register, December, 1981, No. 312, eff. 1-1-82; am. (3) (b) 1., Register, December, 1983, No. 336, eff. 1-1-84; r. and recr. (2), Register, August, 1985, No. 356, eff. 1-1-86; reprinted to correct an error in (2) (intro.), Register, December, 1985, No. 360.

ILHR 64.66 Natatoriums. (1) **POOL VENTILATION.** In natatoriums, a volume of tempered outside air supply and exhaust shall be provided at the rate of at least 2 cubic feet per minute per square foot of pool surface. The volume of tempered outside air and exhaust may be reduced to a minimum of one cubic foot per minute per square foot of pool surface provided humidity controls are used to limit the relative humidity to 60%.

(2) **AIR MOVEMENT.** The air movement in a natatorium shall be not less than 6 air changes per hour unless mechanical cooling is provided to satisfy the heat gain requirement for the space.

History: Cr. Register, December, 1976, No. 252, eff. 1-1-77.

ILHR 64.67 Kitchens (1) **SCOPE.** This classification includes all areas where food is prepared (except in domestic science educational facilities from grades kindergarten through 12, and single unit apartments in hotels, motels and apartment buildings).

(2) **EXHAUST VENTILATION SYSTEMS.** Exhaust ventilation systems serving this occupancy shall not be used for any other service.

(a) *Required exhaust ventilation.* When cooking equipment is being operated, mechanical exhaust ventilation shall be provided at a rate not less than 2 cubic feet per minute per square foot of floor area for every occupied area within the scope of this section. When cooking equipment is not being operated, a minimum supply of outside air and exhaust at the rate of 5 CFM per person or natural ventilation as specified in s. ILHR 64.07 shall be provided during periods of occupancy.

Register, December, 1985, No. 360

(b) *Required exhaust hood.* Exhaust hoods shall be required where frying, including deep-fat frying and surface frying, or broiling or both is conducted as part of a regular commercial operation involving ranges, griddles, fryers, broilers and similar grease-producing equipment.

(3) **REPLACEMENT AIR.** Adequate replacement air shall be provided to equal the air being exhausted by all exhaust systems.

(4) **EXHAUST HOOD REQUIREMENTS.** (a) *Size of hood.* The horizontal inside dimensions for canopy hoods shall be sized to effectively capture grease vapors, but in no case shall these dimensions be less than the overall horizontal dimensions of the grease-producing equipment. The horizontal inside dimensions for noncanopy, prefabricated backshelf hoods may be less than the overall horizontal dimensions of the grease-producing equipment.

(b) *Exhaust rates.* The kitchen exhaust hood shall be provided with a capture velocity to effectively capture the grease vapors and may be designed through engineering analysis or the empirical design formulas stated below:

1. *Canopy hood.* Hood open on all 4 sides: $Q = 150 A$ (area).

2. *Wall hood.* Hood open on 3 sides or less: $Q = 100 A$ (area).

3. *Slotted-type hood.* $V = 350$ feet per minute through the slot opening. The slot shall be at least 3 inches in width and shall extend around the open sides of the hood.

4. *Noncanopy hood.* The minimum volume of exhaust air for noncanopy type hoods (prefabricated backshelf) shall be not less than $Q = 300 L$ (length).

Note: Q equals the exhaust air in cubic feet per minute; A equals the area of the hood over the grease-producing equipment in square feet; V equals the velocity in feet per minute; and L equals the total length in feet of the cooking appliance being ventilated, and measured parallel to the front edge of the appliance.

(c) *Materials.* Hoods shall be constructed and supported by steel not less than .0478 inch U.S. standard gage (No. 18 manufacturers standard gage) or stainless steel not less than .0359 inch U.S. standard gage (No. 20 manufacturers standard gage) or other materials of equivalent strength, fire and corrosion resistance.

(d) *Seams.* All seams and joints shall be liquid-tight.

(e) *Grease-removal devices.* Approved grease extractors, grease filters or other grease-removal devices shall be provided.

(f) *Exposed hood surfaces.* Hood surfaces and exposed exhaust ducts within 18 inches of combustible material shall be protected as specified in sub. (5) (f).

(g) *Concealed hood surfaces.* Hood surfaces that are concealed by or recessed into adjoining construction shall be protected as specified in sub. (5) (f).

(h) *Double-wall hoods utilizing outdoor air.* When hoods are connected to ducts supplying outside air, performance data shall be submitted.

Note: Double-wall hoods provided with a supply of outdoor air conserve energy.

(5) **EXHAUST DUCTS FROM HOODS.** (a) *Design.* All ducts shall lead, as directly as possible, to the exterior of the building without forming dips or traps which collect residues. Ducts exposed to the exterior shall be protected with a suitable weatherproof coating.

Note: Temperatures in excess of 2000° F. may be experienced within ducts in the event of fire. A means of expansion of long ducts should be considered.

(b) *Materials.* Ducts shall be constructed of and supported by steel not lighter than .0598 inch U.S. standard gage (No. 16 manufacturers standard gage) or stainless steel not lighter than .0478 inch U.S. standard gage (No. 18 manufacturers standard gage) or other materials of equivalent strength, fire and corrosion resistance.

(c) *Seams and joints.* All seams and joints shall be liquid-tight.

(d) *Clean-out openings.* Accessible clean-out openings at the sides of ducts shall be provided at each change of direction of the duct for inspection and servicing.

FP (e) *Interior ducts.* Ducts shall not pass through required fire walls or partitions.

FP (f) *Concealed exhaust ducts.* 1. **Horizontal ducts.** Horizontal concealed ducts connected to hoods that pass through any other area of the building, including suspended ceilings, shall be protected with insulating material to withstand a flue temperature of not less than 1000° F. The temperature of the exposed surface of the insulating material shall not exceed 250° F. above the normal ambient temperature of 68° F.

Note: The department will accept the use of masonry chimneys or manufactured chimneys which are tested and approved for use at a flue gas temperature of not less than 1000° F., or insulating materials for fire endurance systems listed in the Fire Resistance Index published by Underwriters' Laboratories, Inc.

2. **Vertical ducts.** Vertical concealed ducts that pass through any other area of the building, including suspended ceilings, in one- and 2-story buildings, shall be protected with insulating material as specified in subd. 1., or shall be located in 2-hour noncombustible fire-resistive enclosures. In buildings of 3 or more stories, vertical ducts shall be located in 2-hour noncombustible fire-resistive enclosures.

FP (g) *Exposed exhaust ducts.* Exposed exhaust ducts connected to hoods or canopies shall be located not less than 18 inches from combustible material unless the duct is protected in accordance with the requirements of par. (f).

(h) *Air discharge.* The air discharge shall be directed away from the roof or combustible materials.

(i) *Dampers.* Fire dampers shall not be installed in kitchen exhaust duct systems unless the assembly includes an approved extinguishing system designed to operate with a fire damper in the closed position.

FP (6) **AUTOMATIC SUPPRESSION SYSTEMS.** Exhaust hoods and ducts in kitchens used for commercial purposes shall be protected by an approved automatic fire suppression system. The suppression system shall comply with the following:

(a) When the fire suppression system is activated, all gas and electrical sources serving cooking appliances, grease consuming appliances or fume Register, August, 1985, No. 356

incinerators and equipment associated with the hoods shall be automatically deactivated. Such gas and electrical sources shall not be capable of reactivation except by manual means after the fire suppression system has been serviced and is again ready for action;

(b) 1. Except as provided in subd. 2., hood and duct suppression systems shall provide for both automatic and manual actuation of the system;

2. Automatic fire sprinkler systems using water need not be provided with means for manual actuation.

(c) A manual station for actuation of the suppression system shall be located at or near one of the means of egress from the area but not nearer than 10 feet to the range hood unless otherwise specifically approved, and shall be securely mounted not less than 4½ feet nor more than 5 feet above the floor;

(d) The system shall be maintained at full operating capacity by the owner and shall be serviced every 6 months; and

(e) All nozzles shall be accessible for cleaning and replacement.

History: Cr. Register, December, 1975, No. 240, eff. 1-1-76; renum. from 64.66, r. and recr. (5) (a) to (d), renum. (5) (e) to (i) to be (5) (d) to (h), am. (6) (b), Register, December, 1976, No. 252, eff. 1-1-77; am. (5) (f) and (g), Register, December, 1977, No. 264, eff. 1-1-78; am. (4) and (6) (f) 1., Register, December, 1978, No. 276, eff. 1-1-79; am. (2)(a), r. (4), renum. (5) and (6) to be (4) and (5), Register, January, 1980, No. 289, eff. 2-1-80; am. (2) (a), (4) (f) and (g), Register, December, 1981, No. 312, eff. 1-1-82; cr. (6), Register, June, 1983, No. 330, eff. 7-1-83; r. and recr. (2) (b), am. (4) (b) 3., Register, December, 1983, No. 336, eff. 1-1-84.

ILHR 64.68 Seasonal occupancies. When approved in writing by the department, heating requirements may be waived but not ventilation required by s. ILHR 64.05, Table 1 during the period of May 15 through September 15 for the following or similar occupancies: drive-in eating places, club houses, outdoor toilets, camp lodge buildings, canning factories and migrant labor camps.

Note: Rules on migrant labor can be found in ch. Ind 201.

History: Cr. Register, December, 1975, No. 240, eff. 1-1-76; renum. from 64.67, Register December, 1976, No. 252, eff. 1-1-77; am., Register, December, 1981, No. 312, eff. 1-1-82.

APPENDIX A

The material contained in the appendix is for clarification purposes only. The notes, illustrations, etc. are numbered to correspond to the number of the rule as it appears in the text of the code.

A-50.21 CERTIFIED MUNICIPALITIES. The following municipalities have been certified by the department to review plans and conduct inspections under this section:

COUNTIES			
Eau Claire			
CITIES			
Antigo	Greenfield	Middleton	Superior
Appleton	Janesville	Muskego	Two Rivers
Beloit	Kaukauna	New Berlin	Waukesha
Brookfield	Kenosha	Oak Creek	Wausau
Burlington	La Crosse	Oshkosh	Wauwatosa
Cudahy	Lake Geneva	Racine	West Allis
Eau Claire	Madison	Sheboygan	West Bend
Fond du Lac	Manitowoc	Sparta	Wisconsin
Glendale	Marshfield	Stevens Point	Rapids
Green Bay	Mequon	Sun Prairie	
VILLAGES			
Dousman			
Elm Grove			
Grafton			
Johnson Creek			
Plover			
Waterford			
TOWNS			
Grand Rapids			
Waukesha			

A-50.10-50.25 FORMS. The following forms (SB2, 8, 8A, 8B, 118, 198, 224B, SBD-4927 and SBD-5686) are referred to in ss. ILHR 50.10, 50.12, 50.14, 50.18, 50.20 and 50.25. Copies of these forms are available from the Division of Safety and Buildings, P.O. Box 7969, Madison, Wisconsin 53707.

SB-2
REV. 8/75

Department of Industry, Labor and Human Relations

Building

Inspection Report and Orders

INSPECTION DATE		FILE NO E -	
OWNERS NAME		OCCUPANCY INSPECTED	
MAILING ADDRESS		LOCATED AT (STREET ADDRESS)	
CITY	STATE	ZIP CODE	CITY COUNTY

An inspection of the above occupancy discloses violations of orders of the Dept. Of Industry, Labor & Human Relations promulgated under authority of Chapter 101 of the Revised Statutes of Wisconsin.

SEE REVERSE SIDE FOR APPLICABLE WISCONSIN STATUTES

Plan No.

NOTE	ITEM	ORDER	REQUIREMENTS:	VI Done	RI Not Done
SAMPLE					

IMPORTANT

- Please report when orders are completed
- Avoid Delay
- Forfeiture for violations are \$10 to \$100 each day for each violation.
- Keep us informed.

"Failure of an employer reasonably to enforce compliance by employees with such statute or order of the Department shall constitute failure by the employer to comply with such statute or order." Sec. 102.57 Wis. Stats.

COMPLIANCE DATE	VIOLETIONS EXPLAINED TO	TITLE
BY	DEPUTY	DEPUTY NO SAFETY & BUILDINGS DIVISION

Address all Correspondence Safety and Buildings Division, Department of Industry, Labor and Human Relations, P.O. Box 2968, Madison, Wisconsin 53702

Appendix A

PETITION FOR VARIANCE OF A RULE IN THE WISCONSIN ADMINISTRATIVE CODE

WISCONSIN DEPARTMENT OF INDUSTRY, LABOR AND HUMAN RELATIONS DIVISION OF SAFETY & BUILDINGS P.O. BOX 7969, MADISON, WI 53707

OFFICE USE ONLY		
Petition No.		
E-Number		
E-		

Name of Owner		Building Occupancy or Use		Agent, Architect or Engineering Firm	
Company		Tenant Name, if any		Street & No.	
Street & No.		Building Location, Street & No.		City State & Zip	
City	State & Zip	City	County	Phone	
Phone		Plan Number(s) IF KNOWN		Name of Contact Person	

1. Rule _____ of the Wisconsin Administrative code cannot be entirely satisfied because:

2. In lieu of complying exactly with the rule, the following alternative is proposed as a means of providing an equivalent degree of safety:

3. Supporting arguments are:

SAMPLE

VERIFICATION BY OWNER - PETITION IS VALID ONLY IF NOTARIZED

For Fee Information See ILHR 69.15 or Contact The Department at (608) 267-7843

NOTE: Petitioner must be building owner. Tenants, agents, designers, contractors, attorneys, etc. may not sign petition unless a Power of Attorney is submitted with the Petition.

_____, being duly sworn, I state as petitioner, that I have read the foregoing petition, that I believe it to be true and I have significant ownership rights in the subject building.

(NAME of PETITIONER Please type/print)

 Signature of Owner
 Subscribed and sworn to me this date: _____
 _____, County, Wisconsin,

 Notary Public
 My commission expires: _____
 56 & IR, 12/84

OFFICE USE ONLY		
Date Received	Amount Paid	Receipt No.
Department Action		
Office of The Secretary	Date	

POSITION STATEMENT:
 To be compiled by
 Chief of Fire Department

WISCONSIN DEPARTMENT OF
 INDUSTRY, LABOR AND HUMAN RELATIONS
 DIVISION OF SAFETY & BUILDINGS
 P.O. BOX 7969 MADISON WI 53707

Name of Owner		Building Occupancy or Use		Agent, Architect or Engineering Firm	
Company		Tenant Name, if any		Street & No.	
Street & No.		Building Location, Street & No.		City State & Zip	
City	State & Zip	City	County	Phone	
1. I have read the petition for variance of rule:					
2. I recommend (Check appropriate box)		Denial	Approval	Conditional Approval	No Comment*
3. Explanation for Recommendation:					
SAMPLE					
* If desired, Fire Departments may indicate "No Comment" on non-fire safety issues such as sanitary, energy conservation, structural, barrier free environments, etc.					
4. <input type="checkbox"/> I find no conflict with local rules and regulations <input type="checkbox"/> I find that the petition is in conflict with local rules and regulations					
Explanation					
Signature of Fire Chief				Date	

PLEASE COMPLETE AND SUBMIT PROMPTLY TO DEPARTMENT OF INDUSTRY, LABOR AND HUMAN RELATIONS AT THE ADDRESS SHOWN ABOVE.
 SB8A (R, 12/84)

Appendix A

Wisconsin Department of Industry, Labor and Human Relations
 DIVISION OF SAFETY & BUILDINGS
 P.O. Box 7869, Madison, WI 53707

POSITION STATEMENT
 To Be Completed By:
 Dept. of HASS
 Division of Health
 SB-B (R 10/84)

Name of Owner of Building		Title			
Street	City	State	Zip	Phone No.	
Building Identification		Street & No. 1861g Location		City & County	
Architect or Engineer		Street & No.		City & State	
1. I have read the Petition for Modification of Rule IND.					
2. I recommend (check appropriate box)		Denial	Approval	Conditional Approval	No Comment
3. Our files or inspection indicate that this building is <input type="checkbox"/> for relative type 1 or 2 (see Ind. 51.0310 or 12). is not <input type="checkbox"/>					
4. Explanation for Recommendation: NOTE - If the answer to Item 3 is NO, and your recommendation is approval, an explanation is required.					
<p style="font-size: 48pt; transform: rotate(-30deg); opacity: 0.5;">SAMPLE</p>					
5. <input type="checkbox"/> I find no conflict with H & SS Rules and Regulations <input type="checkbox"/> I find that the petition is in conflict with H & SS Rules and Regulations as set forth below EXPLANATION:					
Signature and Title					Date

Please complete and submit PROMPTLY to
 DEPARTMENT OF INDUSTRY, LABOR AND HUMAN RELATIONS
 at the address shown above.

Appendix A



Bureau of Buildings and Structures
Division of Safety and Buildings

EFFECTIVE JULY 1, 1985 THROUGH DECEMBER 31, 1985

SEE SCHEDULE: WISCONSIN BUILDING CODE

The following is a schedule of fees charged for some of the services provided by the Bureau of Buildings and Structures. Include the appropriate fee on the plan approval application form (SB-110). For further information refer to code Chapter TRANS 89. A separate SB-110, Plan Approval Application Form, must be submitted for each building.

See the back of this form for information regarding special circumstances.

Plan Type	Criteria	Fees	Comments
Building	0 to 80,000 Cu Ft	\$50	
How and Addition	80,001-1,000,000 Cu Ft	\$1,000/1,000 Cu Ft	Project volume includes all space bounded by bottom of lowest floor, outside surface of enclosing walls, or columns, and top surface of roof. Fee includes footing & foundation, and structural, if submitted with the plans.
	Over 1,000,000 Cu Ft	\$1,000 + .817/1,000 Cu Ft	Reduce building fees 30% for warehouses over 85,715 Cu Ft. Reduce HVAC fee 30% for warehouses over 116,285 Cu Ft. Multiple identical buildings, full fee for first building, minimum fee for balance of buildings.
HVAC	0 to 80,000 Cu Ft	\$50	
How and Addition	80,001-1,000,000 Cu Ft	.75/1,000 Cu Ft	
	Over 1,000,000 Cu Ft	\$50 + .69/1,000 Cu Ft	
Alteration and Remodeling	0 to 3,000 SF	\$50	Area includes floor, roof and exterior wall area being altered or remodeled. Fee includes HVAC and structural if submitted with building plans. If fee calculated exceeds fee based on total building volume, use above fees for new building and new HVAC.
	Over 3,000 SF	\$1.02/sq ft	
HVAC Only	\$0 to \$18,500 (Project Cost)	\$60	
Submitted Separately (Att/Rem)	Over \$18,500 (Project Cost)	\$3.24/\$1,000 Cost	
Illumination	Submitted w/Build or HVAC	\$5	2 identical bldgs - \$10 max.; 3 bldgs - \$15 max.
Submitted Separately		\$20	
Fig. & Plo		\$20	No fee if submitted with building plans
Structural	1 Building, 1 Element	\$25	Fee if submitted with building plan. Multiple buildings must be adjacent or in same complex.
	1 Building, 2 Element	\$40	Correct configurations constitute separate elements.
	2 Buildings, 1 Element	\$40	
	2 Buildings, 2 Element	\$50	
Fire Escapes	Per Escape	\$50	
Stairway	0-2,100 Seats	\$25/1,000 Seats	
Grandstand, Bleacher	2,100 + Seats	\$25/1,000 Seats	
Ind. Exhaust System & Spray Booth	Per System	\$40	Government owned only.
Miscellaneous		\$50	All plan types not mentioned elsewhere.
Revision to Previously Examined Plan		\$50	No fee if revision requested by plan examiner.
Petition for Variance	Per Petition	\$270	
Priority Review	Optional	Double Above Fees	Service available for those who can not wait normal 15 day plan review or 30 day petition time period.
Permission to Start	Optional	\$50	Applies only to projects with footings and foundations.

INSPECTION FEES TO BE SUBMITTED FOR EACH BUILDING OR STRUCTURE

How/Addition	Volume	Area	Fees	Comments
	0 - 25,000	0 - 2,500	\$75	
	25,000 - 50,000	2,500 - 5,000	\$100	
	50,000 - 100,000	5,000 - 10,000	\$150	The minimum inspection fee for buildings with no internal partitions (ex: warehouse and factory) is \$346.00. Fee includes HVAC if HVAC plans are submitted with the building plans.
	100,000 - 200,000	10,000 - 20,000	\$194	
	200,000 - 400,000	20,000 - 40,000	\$263	
	400,000 - 800,000	40,000 - 80,000	\$346	
	800,000 - 1,600,000	80,000 - 160,000	\$455	
	1,600,000 - 3,200,000	160,000 - 320,000	\$586	
	3,200,000 +	320,000 +	\$716	
HVAC Only, or HVAC Submitted Separately from Building Plans			\$75	
Miscellaneous Plans include: Footing & Foundation; Fire Escapes; Stairway; Grandstand; Bleacher; Exhaust System & Spray Booth (Govt. owned); Structural; Unexcavated Foundations			\$75	No separate inspection fee is charged for structural plans, except when a final inspection of the building has been made by our inspector prior to the submittal of the structural plans for the building.

DIANK 580-728(7/85)



DEPARTMENT OF INDUSTRY, LABOR AND HUMAN RELATIONS
 SAFETY & BUILDINGS DIVISION
 P.O. BOX 7969
 MADISON, WISCONSIN 53707

PERMISSION TO START CONSTRUCTION
FEE REQUIRED IN ADDITION TO EXAMINATION/INSPECTION FEES

Location of Project:

Street: _____ E: _____
 City: _____ Plan File Number _____
 Country: _____ Date Plans Rec'd _____
 Occupancy: _____

We, the undersigned, request to begin footing and foundation work prior to approval of the plans in accordance with Ind. 50.14.

Plans have been submitted to the Department of Industry, Labor & Human Relations, Safety and Buildings Division, and all information requested by Code Ind. 50.12 or Ind. 50.13 has been included with the submittal.

We have reviewed the specific code requirements for the building or structure and its use, as set forth in Ind. 50-64, and, where applicable, have shown compliance on the drawings.

We agree to make any changes required after the plans have been reviewed and to remove or replace noncode complying parts of the foundation and/or footings.

We agree to proceed with the footings and foundation only and not to continue with the remainder of the building or structure until approval has been received.

We understand that, prior to the start of construction, a Building Permit must be obtained from the local authorities having jurisdiction in accordance with their laws and ordinances.

SAMPLE

Owner's Signature _____	Date _____	Accepted by _____	Date _____
Name _____		Dept. of Ind., Labor & Human Relations Safety & Buildings Division	
Address: _____		Not Accepted Because _____	
Designer's Signature _____		Plans will be examined within the next _____	
Date _____		days.	
Name _____		NOTE: This permission is applicable to projects having below grade	
Address: _____		foundation work only.	

SI-198-6R, 08-821

FILE COPY

Wisconsin Department of Industry, Labor & Human Relations
 SAFETY AND BUILDINGS DIVISION
 P.O. Box 7989 Madison, Wisconsin 53707

INSPECTION PROGRESS REPORT

RE: _____ TO: _____	<table border="1" style="width:100%; border-collapse: collapse;"> <tr> <td colspan="2" style="text-align: center;">FILE NUMBER</td> </tr> <tr> <td style="width:50%;">DATE OF INSPECTION:</td> <td style="width:50%;">E: _____</td> </tr> <tr> <td>No. 1. _____</td> <td>PERSON CONTACTED _____</td> </tr> <tr> <td>2. _____</td> <td>_____</td> </tr> <tr> <td>3. _____</td> <td>_____</td> </tr> <tr> <td>4. _____</td> <td>_____</td> </tr> <tr> <td>BLDG FINAL _____</td> <td>_____</td> </tr> <tr> <td>H & V FINAL _____</td> <td>_____</td> </tr> <tr> <td>OTHER FINAL _____</td> <td>_____</td> </tr> <tr> <td colspan="2" style="text-align: center;">COMPLIANCE DATE _____</td> </tr> <tr> <td colspan="2">OFFICE INSTRUCTION (Check one)</td> </tr> <tr> <td><input type="checkbox"/> Voluntary compliance</td> <td rowspan="3" style="vertical-align: top;">Supervisor Review</td> </tr> <tr> <td><input type="checkbox"/> Process SB-2</td> </tr> <tr> <td><input type="checkbox"/> Code violations explained to owner</td> </tr> </table>	FILE NUMBER		DATE OF INSPECTION:	E: _____	No. 1. _____	PERSON CONTACTED _____	2. _____	_____	3. _____	_____	4. _____	_____	BLDG FINAL _____	_____	H & V FINAL _____	_____	OTHER FINAL _____	_____	COMPLIANCE DATE _____		OFFICE INSTRUCTION (Check one)		<input type="checkbox"/> Voluntary compliance	Supervisor Review	<input type="checkbox"/> Process SB-2	<input type="checkbox"/> Code violations explained to owner
FILE NUMBER																											
DATE OF INSPECTION:	E: _____																										
No. 1. _____	PERSON CONTACTED _____																										
2. _____	_____																										
3. _____	_____																										
4. _____	_____																										
BLDG FINAL _____	_____																										
H & V FINAL _____	_____																										
OTHER FINAL _____	_____																										
COMPLIANCE DATE _____																											
OFFICE INSTRUCTION (Check one)																											
<input type="checkbox"/> Voluntary compliance	Supervisor Review																										
<input type="checkbox"/> Process SB-2																											
<input type="checkbox"/> Code violations explained to owner																											

INSP.	<input checked="" type="checkbox"/> Order Corrected <input checked="" type="checkbox"/> Order Not Corrected	1	2	3	4	Final	ORDER NUMBER	FINDINGS OF INSPECTION
<div style="font-size: 48px; opacity: 0.5; transform: rotate(-45deg); position: absolute; top: 50%; left: 50%;">SAMPLE</div> <p>Items listed must be corrected before the next inspection or final inspection. If corrections are not made prosecution by the Attorney General's Office will result.</p>								

NAME AND ADDRESS OF CONTRACTOR:		
OWNER'S NAME (if different from above):	DEPUTY SIGNATURE	REG. NO.
ADDRESS	IF YOU HAVE ANY QUESTIONS I WILL BE IN MY OFFICE ON:	
CITY STATE ZIP		
DILHR-SB-224B (R. 4/80)		
TELEPHONE _____		

WORK COPY

Wisconsin Department
of Industry, Labor
and Human Relations

COMPLETION STATEMENT



E-Number: E- _____
Receipt Component 99

Return to:

Safety and Buildings Division
P.O. Box 7869
Madison, Wisconsin 53707

Administrative Rules require that a Completion Statement be filed by the Supervising Professional or Designer for all buildings having a volume of over 50,000 cubic feet. (Reference Ind 50.10 (3))

Owner	Plan Number
Occupancy	Building Street Address
Municipality	County

This is to certify that construction of the referenced project was under my supervision, in accordance with Ind 50.10, and that to the best of my knowledge and belief it has been completed in substantial compliance with the approved plans and specifications with the following exceptions: (if none, state 'none')

SAMPLE



This Certificate Covers:	
<input type="checkbox"/> Building	<input type="checkbox"/> Heating & Ventilation
<input type="checkbox"/> Other (specify) _____	

Supervising Professional Name (Please Print or Type)	Signature	Registration Number
Street Address	City, State, Zip	Date
		Mo Day Year
Office Use Only Safety Specialist _____		

DILHR 580-4927 (R. 7/83)

FILE

DEPARTMENT OF INDUSTRY, LABOR AND HUMAN RELATIONS
 SAFETY & BUILDINGS DIVISION
 201 E. WASHINGTON AVE.
 P.O. Box 7869
 MADISON, WISCONSIN 53707

PLAN EXAMINATION LETTER

FILE NO. E- _____
PLAN NO. _____
VOL. _____
INSP. FEES PAID _____

DATE _____

Note: This Preprinted Plan Review letter is being used at the discretion of the plan examiner to expedite the plan review. This form serves as the review correspondence.

Occupancy _____
 Tenant _____
 Owner _____
 Location _____
 Municipality _____
 County _____
 Supervising Professionals _____

Plans have been reviewed by the Department of Industry, Labor and Human Relations for compliance with important code requirements.

The _____ plans are:

<input type="checkbox"/> COND. APPROVED	<input type="checkbox"/> WITHHELD	<input type="checkbox"/> NOT APPROVED
---	-----------------------------------	---------------------------------------

If the plans are stamped "CONDITIONALLY APPROVED" construction may proceed, but all items that are required to be changed by this letter must be corrected before commencing that part of the work.

You are hereby advised that the owner as defined in Chapter 101.01(2)(h) of the Wisconsin State Statute is responsible for all code requirements not specifically cited herein. Code requirements are set forth in Chapters 50 through 64 of the rules of the department.

The building will be inspected during and after construction by a department inspector to insure complete compliance with Wisconsin Codes. The owner may notify the state building inspector listed below if a final inspection is desired before taking possession of the building.

IND. 50.15 EVIDENCE OF APPROVAL. The architect, professional engineer, designer, builder or owner shall keep at the building site, one set of plans bearing the stamp of approval.

THIS BUILDING HAS BEEN CLASSIFIED AS NO. _____ CONSTRUCTION SPRINKLERED UNLIMITED AREA

COMMENTS _____

Plans for the following shall be submitted to this office and approved prior to construction of that component.

Trusses _____
 Precast Concrete _____
 Heat & Vent Systems _____
 Illumination _____
 And Code _____

State Inspector: Reg. _____ Phone: _____
 Local Inspector: _____

BY _____
 PLAN EXAMINER
 Phone: _____

DCLH 580 5826 (R 05/83)

A-51.01 (12) BUILDING. The intent was to consider permanent awnings as part of a building.

A-51.01 (42) FAMILY. The intent of this definition is to clarify the use of the word "family" in reference to s. ILHR 51.01 (102a); it is not intended as a variance to the definition stated under s. ILHR 51.01 (102a) (b).

A-51.01 (67a) HABITABLE ROOM. It is the intent that rooms designated as recreation, study, den, family room, office, etc. and providing the only space for living and/or sleeping are considered habitable rooms.

A-51.01 (115) SETBACK. The intent was to not include gutters, downspouts, outdoor lighting fixtures, signs and similar attachments as parts of a building.

A-51.01 (121) STORIES, NUMBER OF. For further clarification, refer to A-51.02 (14).

A-51.01 (144) WALL (DIVISION).

- (a) *Building division wall* is intended to denote a wall constructed in a manner sufficient to meet requirements for a party wall [see "Wall (Party)"] and is acceptable as a dividing wall or enclosing wall when determining the volume of a building as referred to in ss. ILHR 50.07, 50.10 and 50.12.
- (b) *Fire division wall* is intended to relate to construction that provides separation between portions of a building to satisfy allowable floor area limitations, separation between 2 classes of construction, or separation of hazardous occupancies. For other separations, see "occupancy separations" and isolation of hazards sections of this code.

A-51.01 (151) WALL (PARTY). It is intended that a property consisting of joining plotted subdivisions owned by one individual, that can be owned by separate individuals, is included in the definition of party wall.

Appendix A

A-51.02 (14) DETERMINATION OF NUMBER OF STORIES. The following illustrations are provided to give visual aid to this rule and the definition of s. ILHR 51.01 (121) Stories, Number of.

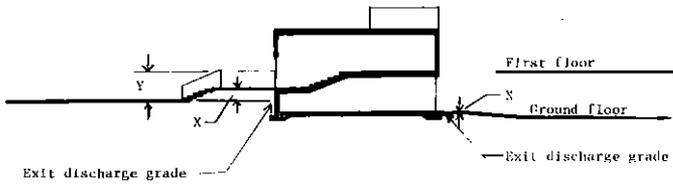

Note: $X = 3'-0''$ (maximum)
 $Y = 3'-0''$ (maximum)

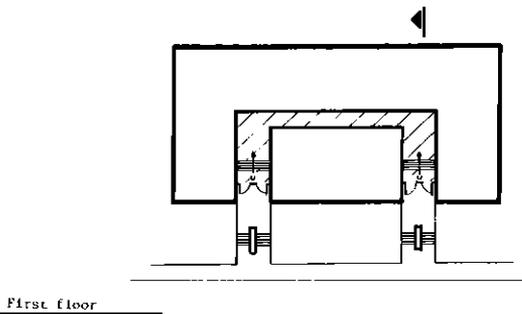
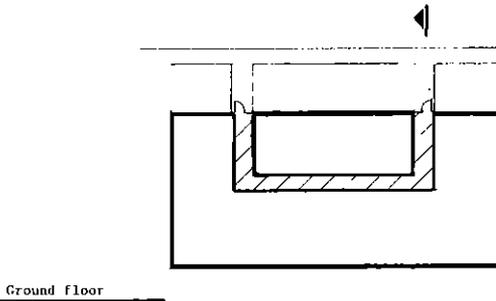

A-51.03 (5) (a) EXTERIOR MASONRY CONSTRUCTION. The following Figures 1, 2, 3, 4, 5A and 5B illustrate typical details for various wall construction alternatives, which satisfy the intent of this rule for Type 5—Exterior Masonry Construction.

This Figure Illustrates Typical Details for an Exterior Wall. The Same Details also are Applicable to Interior Walls.

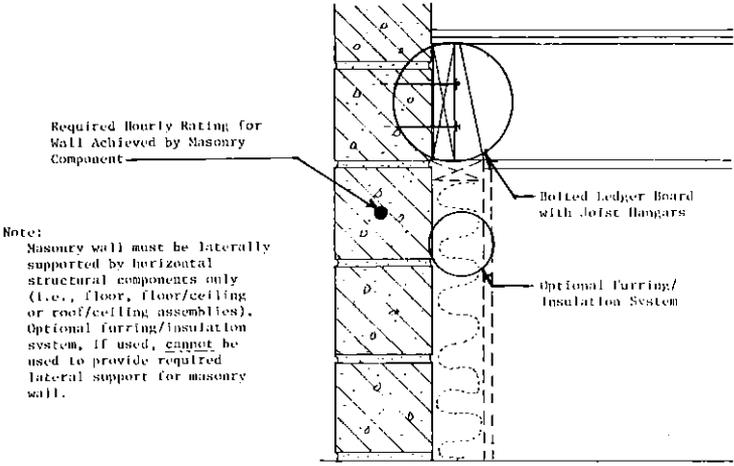

FIGURE 1
Single Wythe Masonry Wall
(Bearing Condition)

Appendix A

This Figure Illustrates Typical Details for an Exterior Wall. The Same Details also are Applicable to Interior Walls.

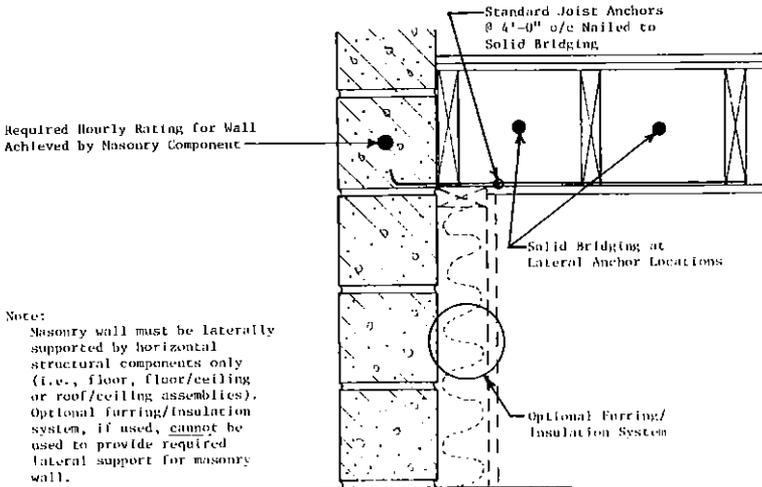

FIGURE 2
Single Wythe Masonry Wall
(Non-Bearing Condition)

This Figure illustrates Typical Details for an Exterior Wall. The Same Details also are Applicable to Interior Walls.

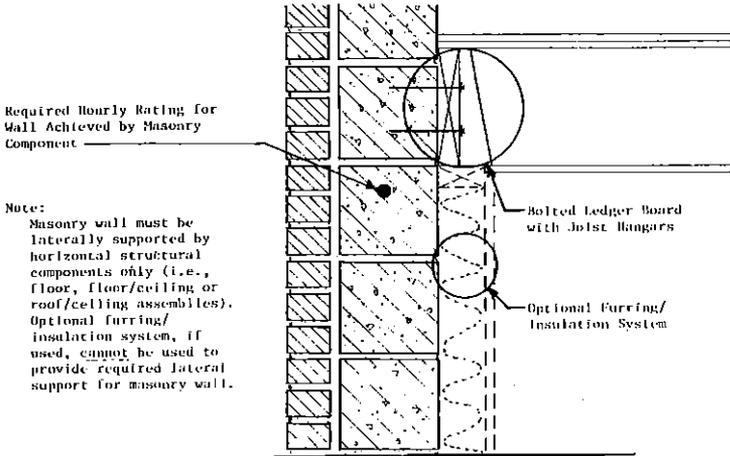
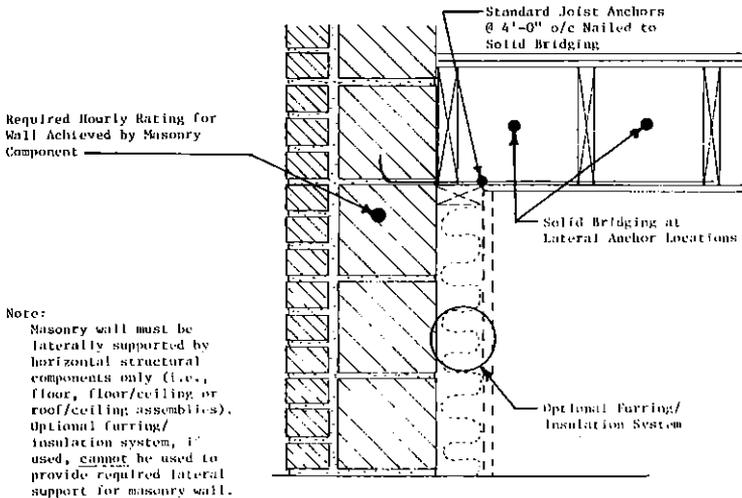

FIGURE 3
Multi-Wythe Masonry Wall
(Bearing Condition)

Appendix A

This Figure illustrates Typical Details for an Exterior Wall. The Same Details also are Applicable to Interior Walls.



Note:

Masonry wall must be laterally supported by horizontal structural components only (i.e., floor, floor/ceiling or roof/ceiling assemblies). Optional furring/insulation system, if used, cannot be used to provide required lateral support for masonry wall.

FIGURE 4
Multi-Wythe Masonry Wall
(Non-Bearing Condition)

This Figure illustrates Typical Details for an Exterior Wall. The Same Details are also Applicable to Interior Walls.

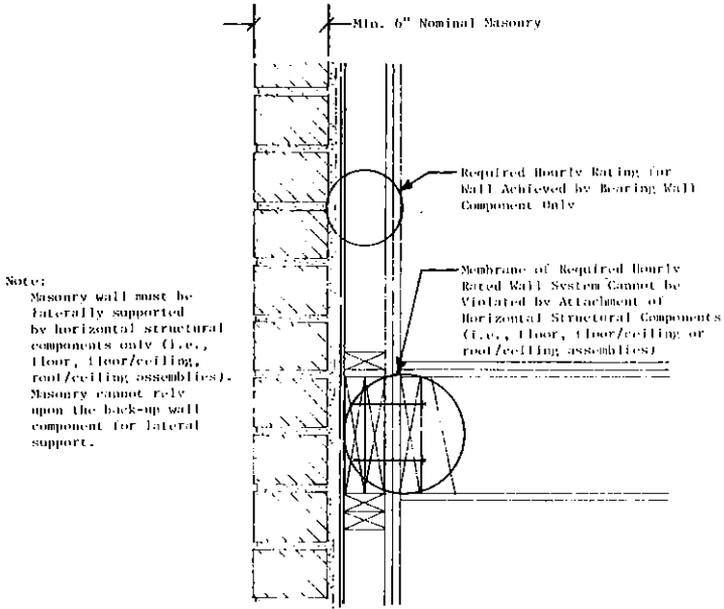

FIGURE 5A
Combination Masonry/Frame Wall
(Bearing and Non-Bearing Condition)

This Figure Illustrates Typical Details for an Exterior Wall. The Same Details also are Applicable to Interior Walls.

Note:

Masonry wall must be laterally supported by horizontal structural components only (i.e., floor, floor/ceiling or roof/ceiling assemblies). Masonry cannot rely upon the back-up wall component for lateral support.

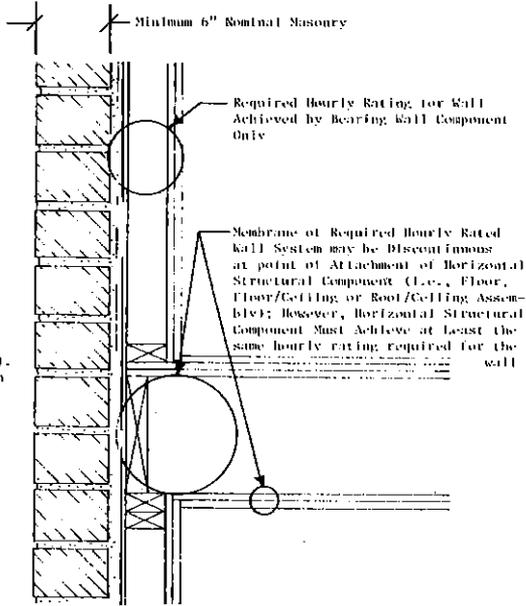

FIGURE 5B
Combination Masonry/Frame Wall
(Bearing and Non-Bearing Condition)

A-51.15 (6) EXAMPLE TO DETERMINE TOTAL AGGREGATE EXIT WIDTH.

5	300
4	400
3	500
2	200
1	600
B ₁	100
B ₂	300
B ₃	400

Type No. 1 sprinklered construction.

Aggregate exit width required from a floor into the stairwell is 30 inches per 100 people on that floor; i.e.,

5th floor to stairwell = $3 \times 30 = 90''$

4th floor to stairwell = $4 \times 30 = 120''$

3rd floor to stairwell = $5 \times 30 = 150''$

etc.

Total stair width required:

5th to 4th - 300 persons (100%) $\times 30''/100$ persons = 90"

4th to 3rd - [400 persons (100%) + 300 persons (50%)] $30''/100$ persons = 165"

3rd to 2nd - [500 persons (100%) + 400 persons (50%) + 300 persons (25%)] $30''/100$ persons = 232.5"

2nd to 1st - [200 persons (100%) + 500 persons (50%) + 400 persons (25%)] $30''/100$ persons = 165" (Use 232.5")

1st to exterior - [600 persons (100%) + (200 persons + 100 persons) (50%) + (500 persons + 300 persons) (25%)] $30''/100$ persons = 285"

B₁ to 1st - [100 persons (100%) + 300 persons (50%) + 400 persons (25%)] $30''/100$ persons = 105" (Use 150")

B₂ to B₁ - [300 persons (100%) + 400 persons (50%)] $30''/100$ persons = 150"

B₃ to B₂ - 400 persons (100%) $\times 30''/100$ persons = 120"

Stair width required from B₁ to 1 is 150" as stair cannot decrease in width along path to exit [Ind 51.16 (2) (c)].

A-51.151 EXIT DISTRIBUTION. The following diagrams are provided to aid building designers in determining proper exit distribution:

Appendix A

ARRANGEMENT OF EXITS

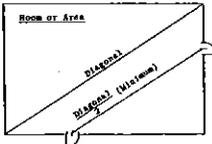

Minimum Distance - One-half of Diagonal

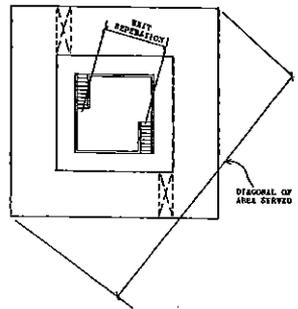
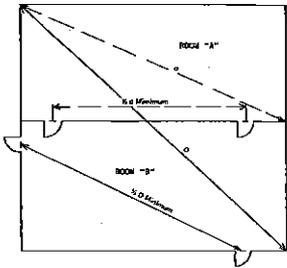
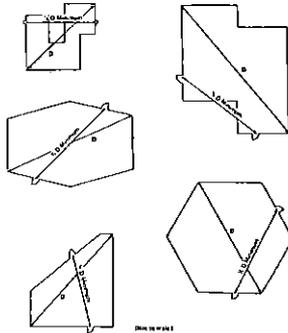

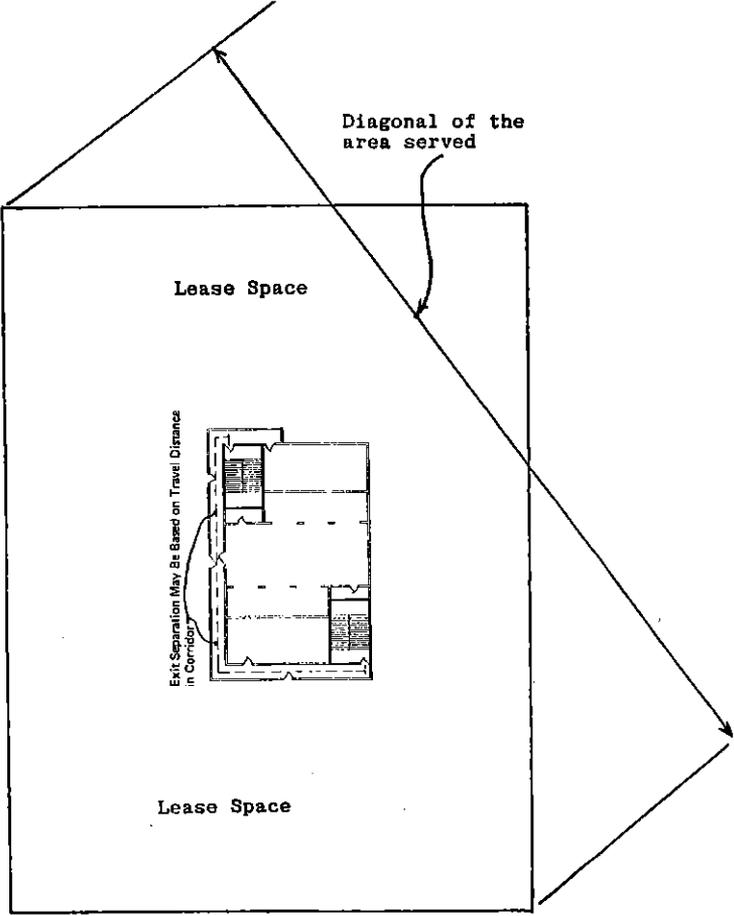

Appendix A

A-51.22 FIRE EXTINGUISHERS. The following information is taken from the National Fire Protection Association Standard #10-1984 - Portable Fire Extinguishers. The information is provided to assist building designers in determining the number, type and location of fire extinguishers needed to comply with the provisions of the standard.

1-4 Classification and ratings of fire extinguishers.

1-4.1 Portable fire extinguishers are classified for use on certain classes of fires and rated for relative extinguishing effectiveness at a temperature of plus 70°F by testing laboratories. This is based upon the preceding classification of fires and the fire-extinguishment potentials as determined by fire tests.

1-4.2 The classification and rating system described in this standard is that used by Underwriters Laboratories, Inc., and Underwriters Laboratories of Canada and is based on extinguishing preplanned fires of determined size and description as follows:

Class A Rating — Wood and excelsior.

Class B Rating — Two-inch depth n-heptane fires in square pans.

Class C Rating — No fire test. Agent must be a nonconductor of electricity.

Class D Rating — Special tests on specific combustible metal fires.

1-5 CLASSIFICATION OF HAZARDS.

1-5.1 Light (low) hazard. Locations where the total amount of Class A combustible materials, including furnishings, decorations and contents, is of minor quantity. These may include buildings or rooms occupied as offices, classrooms, churches, assembly halls, etc. This classification anticipates that the majority of contents items are either noncombustible or so arranged that a fire is not likely to spread rapidly. Small amounts of Class B flammables used for duplicating machines, art departments, etc., are included provided that they are kept in closed containers and safely stored.

1-5.2 Ordinary (moderate) hazard. Locations where the total amount of Class A combustibles and Class B flammables are present in greater amounts than expected under light (low) hazard occupancies. These occupancies could consist of offices, classrooms, mercantile shops and allied storage, light manufacturing, research operations, auto showrooms, parking garages, workshop or support service areas of light (low) hazard occupancies and warehouses containing Class I or Class II commodities as defined by NFPA 231, Standard for Indoor General Storage.

1-5.3 Extra (high) hazard. Locations where the total amount of Class A combustibles and Class B flammables are present, in storage, production use and/or finished product over and above those expected and classed as ordinary (moderate) hazards. These occupancies could consist of woodworking, vehicle repair, aircraft and boat servicing, individual product display showrooms, product convention center displays, storage and manufacturing processes such as painting, dipping, coating, including flammable liquid handling. Also included is warehousing of, or in-process storage of other than Class I and Class II commodities.

3-2 FIRE EXTINGUISHER SIZE AND PLACEMENT FOR CLASS A HAZARDS.

3-2.1 Minimal sizes of fire extinguishers for the listed grades of hazards shall be provided on the basis of Table 3-2.1 except as modified by 3-2.3. Extinguishers shall be located so that the maximum travel distances shall not exceed those specified in Table 3-2.1, except as modified by 3-2.3.

3-2.1.1 Certain smaller extinguishers which are charged with multipurpose dry chemical or Halon 1211 are rated on Class B and Class C fires, but have insufficient effectiveness to earn the minimum 1-A rating even though they have value in extinguishing smaller Class A fires. They shall not be used to meet the requirements of 3-2.1.

3-2.2 Up to one-half of the complement of extinguishers as specified in Table 3-2.1 may be replaced by uniformly spaced 1½ inch hose stations for use by the occupants of the building. When hose stations are so provided they shall conform to NFPA 14, Installation of Standpipe and Hose Systems. The location of hose stations and the placement of fire extinguishers shall be in such a manner that the hose stations do not replace more than every other extinguisher.

3-2.3 Where the floor area of a building is less than that specified in Table 3-2.1, at least one extinguisher of the minimum size recommended shall be provided.

3-2.4 The protection requirements may be fulfilled with extinguishers of higher rating provided the travel distance to such larger extinguishers shall not exceed 75 feet.

Table 3-2.1

	Light (Low) Hazard Occupancy	Ordinary (Moderate) Hazard Occupancy	Extra (High) Hazard Occupancy
Minimum rated single extinguisher	2-A	2-A	4-A
Maximum floor area per unit of A	3,000 sq. ft.	1,500 sq. ft.	1,000 sq. ft.
Maximum floor area for extinguisher	11,250 sq. ft.	11,250 sq. ft.	11,250 sq. ft.
Maximum travel distance to extinguisher	75 ft.	75 ft.	75 ft.

*Two 2½ gal water type extinguishers can be used to fulfill the requirements of one 4-A rated extinguisher.

A52.011 HAZARD CLASSIFICATIONS. The following information is provided to assist building owners and designers in determining the hazard classifications of typical building usage or occupancy:

HAZARD CLASSIFICATION	DESCRIPTION OF FUEL LOAD	TYPICAL EXAMPLES
Low Hazard	Buildings or structures used for the manufacture or storage of noncombustible or low hazard materials, that do not ordinarily burn rapidly, such as but not limited to: asbestos; chalk; non-alcoholic beverages; brick and masonry; ceramic products; gypsum; glass and metals; foods in noncombustible containers; fresh fruits and vegetables in non-plastic containers; dairy products in non-wax coated paper containers; beer or wine in metal or glass containers; electrical motors and coils; and fertilizer.	Metal fabricating and assembly; foundries; water pumping and waste water treatment plants; fertilizer storage; telephone exchanges; freezer warehouses; storage in closed front metal cabinets; storage of noncombustible or low hazard materials on wood pallets or in paper cartons without significant amounts of combustible wrappings; and similar occupancies with slight combustibles.
Moderate Hazard	Buildings and structures used for the manufacture or storage of moderate hazard materials, which are likely to burn with moderate rapidity, but which do not produce either poisonous gases, fumes or explosives, such as but not limited to: cloth, burlap and paper bags; bamboo and rattan; canvas and leather belting; baskets; books and paper in rolls or packs; boots and shoes; cardboard and cardboard boxes; clothing; cordage; furniture; furs; glue, mullage, paste and size; linoleum; silk; soap; sugar; tobacco products; wax candles; athletic equipment; musical instruments; beverages containing more than 12% alcohol; furniture other than metal; business machines; electronics; and plastic products not classified as high hazard.	Mercantile storage and display; offices; school-rooms; auto showrooms; aircraft storage; light manufacturing; school shop areas; leather enameling or japanning operations; grain elevators with less than one million bushel bulk storage capacity; livestock shelters; fertilizer bagging operations; feed, flour and grist mills; lumber yards; motor vehicle repair shops; petroleum warehouses for storage of lubricating oils with a flash point of 200°F. or higher; photo engraving operations; public garages; stables; upholstering and mattress manufacturing; aircraft servicing; woodworking and millworking; bakeries; boat building operations; food processing; condensed and powdered milk manufacturing; paper mills or products; printing or publishing; refuse incinerators; and textile mills.
High Hazard	Buildings and structures used for the storage, manufacture or processing of: highly combustible or explosive products or materials, which are likely to burn with extreme rapidity or which may produce poisonous fumes or explosions; highly corrosive, toxic or noxious alkalies, acids or other liquids or chemicals producing flame, fumes, poisonous, irritant or corrosive gases; materials producing explosive mixtures or dusts or which result in the division of matter into fine particles subject to spontaneous ignition.	Ammunition, explosive and firework manufacture; artificial flowers and synthetic leather manufacture; celluloid and celluloid products; cotton batting and waste processes; dry cleaning establishments using or storing more than 3 gallons of flammable liquids with a flash point below 100°F. or more than 60 gallons of flammable liquids with a flash point between 100°F. and 140°F.; feather renovating; fruit ripening processes; grain elevators with one million bushel or more bulk storage capacity; hydrogenation processes; match manufacture and storage; metal enameling and japanning; nitro-cellulose film exchanges and laboratories; paint and varnish manufacture; petroleum manufacture; processing of paper or cardboard in loose form; pyroxylin product storage and manufacture; smoke houses; factories or warehouses where loose combustible fibers or dust are manufactured, processed, generated or stored; handling or using flammable liquids under conditions involving possible release of flammable vapors; and fabrication facilities and research and development areas in which hazardous production materials are used.

A-52.04 REQUIREMENTS FOR BARRIER-FREE ENVIRONMENTS. The following illustrations are provided to give the designer visual aids for making facilities accessible.

WHEELCHAIR DIMENSIONS

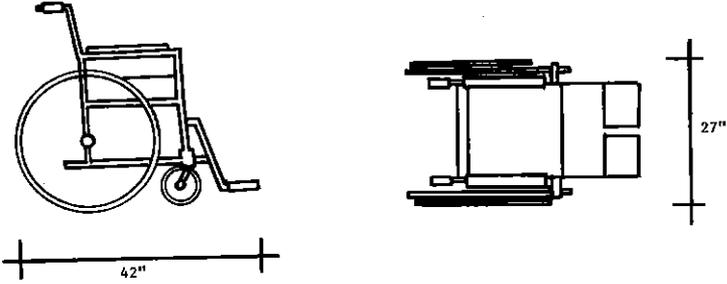

TURNING SPACE

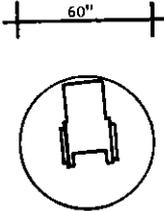

180-360° Turn

DOORS IN SERIES

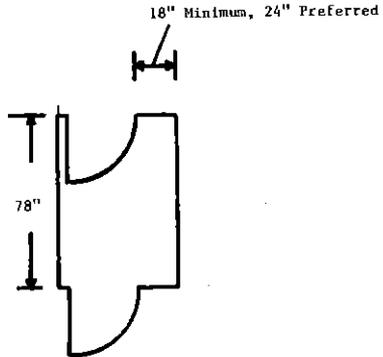

Doors in series should be hinged on the same side and should swing in the same direction. A minimum of 18 inches of clear space should be provided on the door knob side of the door. The length of the vestibule should be a minimum of 78 inches.

Appendix A

EXAMPLES OF ACCESSIBLE TOILET COMPARTMENTS AS SPECIFIED IN TABLE 52.04-A

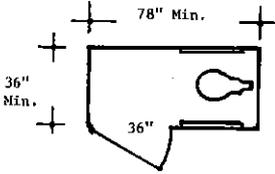

Recommended fixtures:

- 1. Elongated bowl;
- 2. Wall mounted.

Note: These are examples of toilet room compartments which are located within accessible toilet rooms.

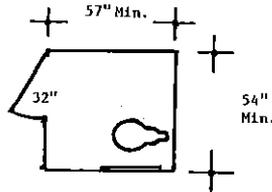
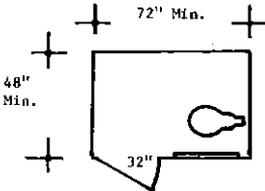
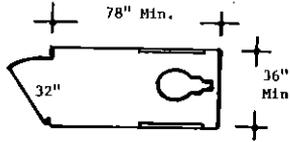
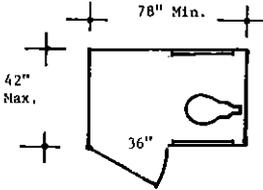

The door of the 54" x 57" water closet compartment having a frontal approach should not align with the placement of the water closet.

EXAMPLES OF ACCESSIBLE TOILET ROOMS
CONTAINING ONE LAVATORY AND ONE WATER CLOSET

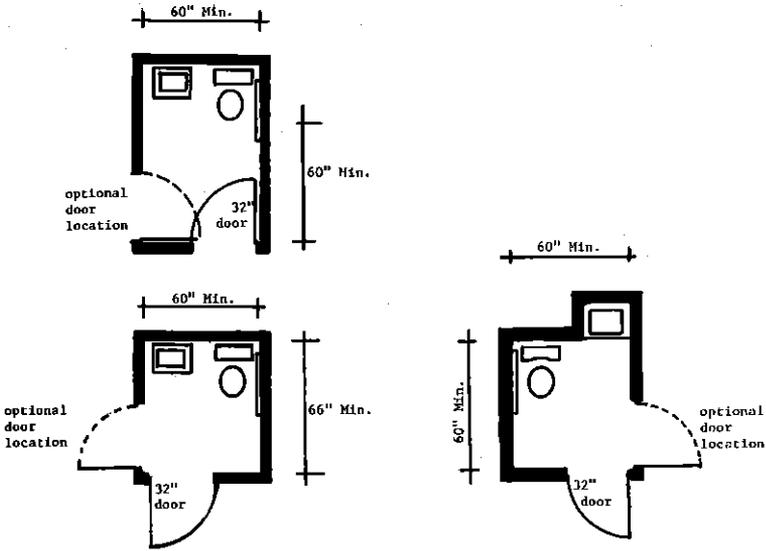

Note #1: These examples of accessible toilet rooms may be used in health care facilities in that sufficient room for the attendant is provided.

Note #2: These examples may be modified by substituting pocket sliding doors for the swing doors shown in the examples. Surface-mounted hardware is recommended for pocket sliding doors.

Appendix A

A-52.04 (3) (a) **SITE REQUIREMENTS — PARKING SPACE IDENTIFICATION.** The following is a reprint of Wisconsin Department of Transportation's administrative rule, s. Trans 200.07, dealing with the signage for parking spaces designated for the physically disabled:

Trans 200.07 Handicapped parking signs. (1) **PURPOSE.** The purpose of this section is to define and illustrate the design, size and installation requirements of the official traffic signs required under s. 346.503 (1), Stats., related to reserved parking spaces for handicapped persons.

(2) **SIGN DESCRIPTION.** (a) The sign shall consist of a white rectangle with longer dimension vertical, having green message, a green arrow, if required under this section, and a blue and white international symbol for the barrier-free environments. The sign may be reflective or nonreflective.

(b) The sign shall include the words "reserved parking" and the words "vehicles with VET or DIS plates or state disabled card" or other words with a similar meaning.

(c) The size of the sign shall be not less than 12 inches by 18 inches. When used on a highway with a speed limit of more than 35 miles per hour, it shall be not less than 18 inches by 24 inches.

(d) A right arrow, left arrow or the words "This Stall" or similar wording shall be included near the bottom of the sign.

(3) **SIGN PLACEMENT.** Each sign shall be erected on an adequate support. On highways, the vertical distance from roadway to the bottom of a sign shall be not less than 7 feet, except when overhead obstructions necessitate a lower height. In off-highway parking lots, the vertical distance from the parking lot surface, or top of curb if any, to the bottom of a sign shall be not less than 4 feet. A single sign with the message "This Space" or similar wording shall be used to designate a single reserved space. At least 2 signs are required for multiple reserved spaces. When 2 signs are used they shall be located at the outermost limits of the spaces reserved and, by arrow, designate the location of the reserved spaces.

(a) A sign shall be located at the end of an angled or right-angled space and shall be set to face a motorist entering the space.

(b) When the reserved space is parallel to the edge of a roadway, a sign shall be set at an angle of approximately 30° degrees with the line of traffic.

(4) Signs which are in place prior to the effective date of this section may remain in place and have the same effect as the signs described herein for 5 years after the effective date of this chapter provided that they include the international symbol for barrier-free environments and the wording required under (2) (b) either as part of the original sign or on a supplementary plaque or plaques. The requirements under (3) do not apply to these signs.

(5) **ENFORCEMENT.** The provisions of this rule shall be enforced by order of the department. District transportation directors shall be responsible for the issuance of all orders regarding noncompliance.

A-52.04 (3) (b) **SITE REQUIREMENTS — CURB RAMPS.** The following is a reprint of s. 66.616 (3) (a), Stats., dealing with the design and construction of curb ramps:

(a) Curb ramping shall be of permanent construction. The ramp shall be at least 40 inches wide. The sides of the ramp shall slope from the sidewalk or apron elevations to the ramp elevation with the widest portion of the side slope not less than 18 inches nor more than 24 inches wide at the curb. The ramp slope may not exceed one inch vertical to 12 inches horizontal from the flow line elevation of the curb. The curb opening shall be not less than 40 inches nor more than 80 inches wide at the flow line of the curb. The taper of the curb from the top of the curb to the flow line of the curb at the curb opening shall be not less than 18 inches nor more than 24 inches wide. The ramp shall be bordered on both sides and on the curb line with a 4-inch-wide yellow stripe or with brick of a contrasting color.

A-52.04 (3) (a) Parking spaces. Where parking spaces are provided, accessible parking spaces, at least 12 feet wide, shall be provided and designated as specified in Table 52.04-A. Access ramps or curb ramps shall not be located in the accessible parking space or any other parking space.

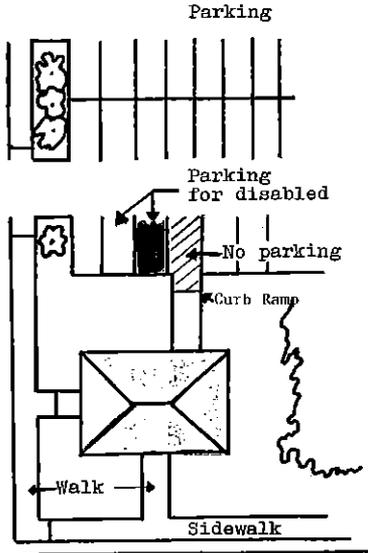

EXAMPLES OF GRASPABLE HANDRAILS

A-52.04 (3) (d) 3. and
(7) (c)

The handgrip portion of the handrail, if round, shall be not less than 1-1/4 in. nor more than 2 in. in diameter. If the shape of the handrail is not round, then the larger dimension shall be not more than 2 in.

If handrails are mounted adjacent to walls or other surfaces, provide a 1-1/2 in. - 2 in. clear space between the surface and the handrail. The handrail and the surfaces adjacent to the handrail shall be free of any sharp or abrasive elements.

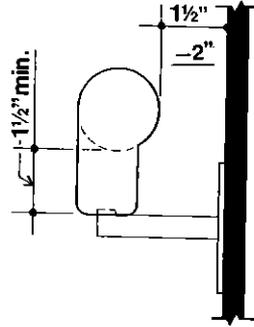

handrail

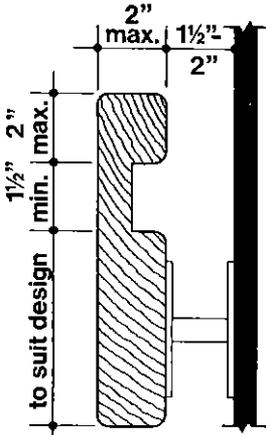

handrail

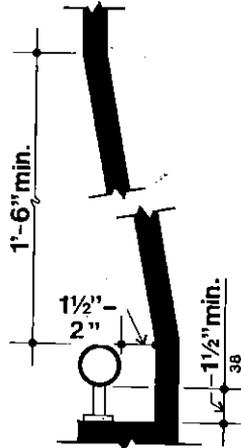

handrail

A-52.04 (4) (b) LIFTS FOR THE PHYSICALLY DISABLED. Information for lifting devices for the physically disabled and procedures for approval may be obtained from the Division of Safety and Buildings, Bureau of Technical Services, Elevator Section, P.O. Box 7969, Madison, Wisconsin 53707.

Appendix A

ILHR 52.04 (8) TOILET FACILITY DETAILS. (a) *Accessible toilet rooms and compartments.* Accessible toilet rooms and toilet compartments shall be sized to provide ease of access, usability and uninterrupted mobility. Fixtures, doors and other obstructions shall be arranged to insure accessibility.

The space underneath lavatories can be utilized in sizing a toilet room for accessibility.

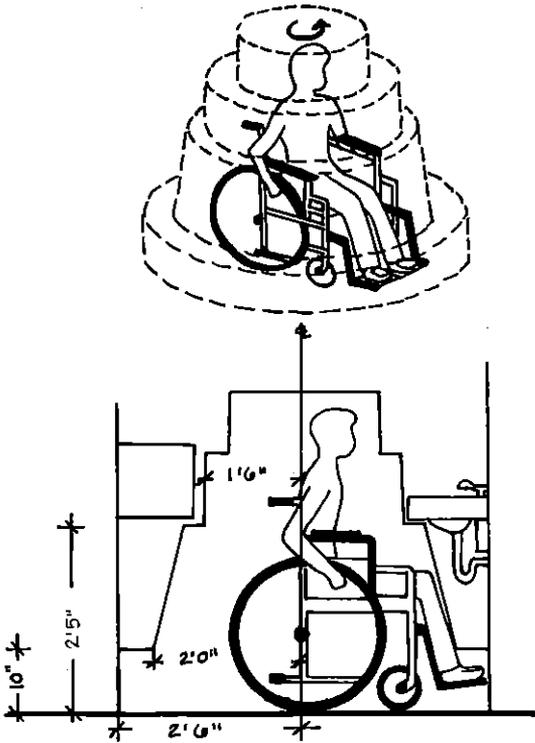

ACCESSIBLE TOILET ROOMS

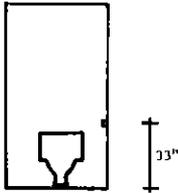

It is recommended that grab bars be from 30 to 42 inches in length and located no more than 12 inches from the back wall.

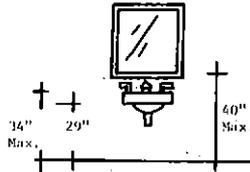
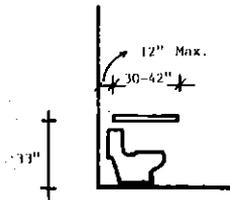

ACCESSIBLE BATHING FACILITIES

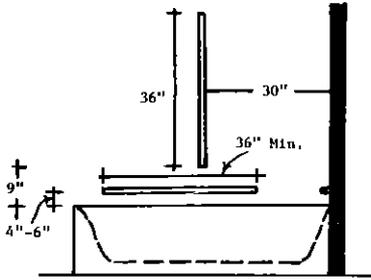

Side Elevation - Bathtub

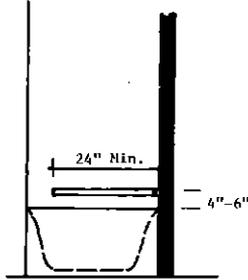

End Elevation - Bathtub

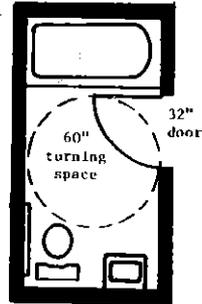
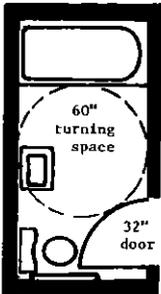

These diagrams are examples of accessible bathrooms which may be used for motels, hotels, hospitals and nursing homes.

ACCESSIBLE BATHING FACILITIES

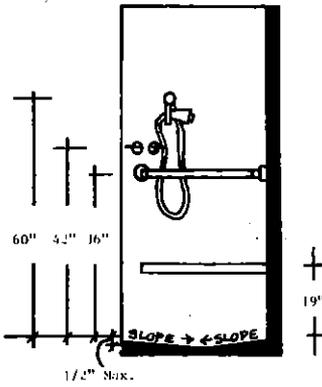

Section View - Shower

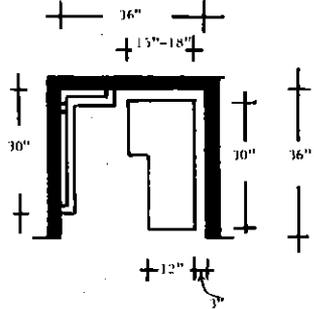

Plan View - Shower

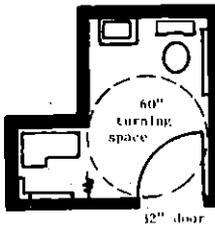

Appendix A

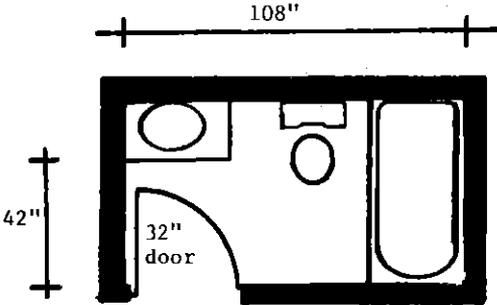
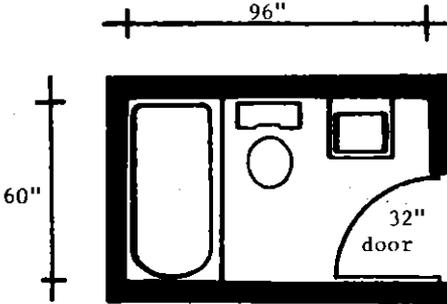
**EXAMPLES OF ADAPTABLE BATHROOM LAYOUTS
FOR RESIDENTIAL LIVING UNITS
(not including hotels and motels)**

These examples may be modified for accessibility by using outward swinging doors or pocket sliding doors.

EXAMPLES OF ACCESSIBLE WATER COOLERS

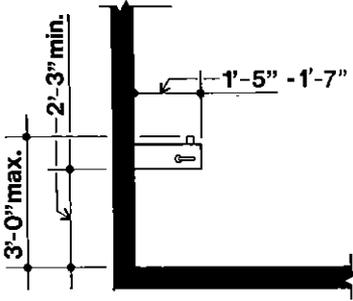

cantilevered
drinking fountain

A-52.04 (11) (a) 4.a. Wall and postmounted cantilevered units shall have a clear knee space between the bottom of the apron and the floor or ground at least 27 inches high, 32 inches wide, and 17 inches to 19 inches deep.

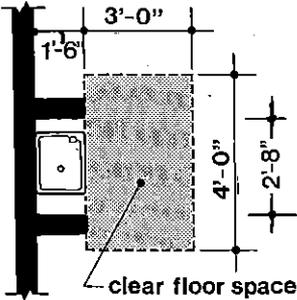

built in
drinking fountain

A-52.04 (11) (a) 5. 'Alcoves'. Water fountains and water coolers shall be located completely within alcoves, or positioned so as not to encroach into pedestrian walkways. Alcoves shall be not less than 32 inches in width and 18 inches in depth.

EXAMPLES OF ACCESSIBLE WATER COOLERS

A-52.04 (11) (a) 4.b.

Free-standing or built-in units not having a clear space under them shall have a clear floor space at least 36 inches by 48 inches that allows a person in a wheelchair to make a parallel.

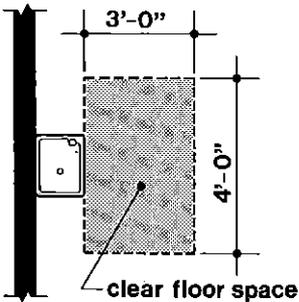

**free standing
or wall hung**
drinking fountain

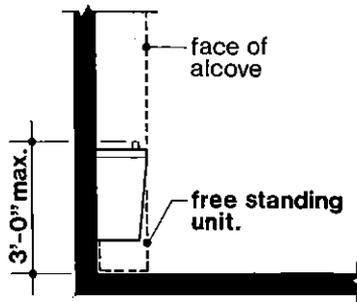

**free standing
or wall hung**
drinking fountain



INTERNATIONAL SYMBOL FOR BARRIER-FREE
ENVIRONMENTS

Appendix A

A 52.07 (11) ACCEPTANCE OF THE ATRIUM SMOKE CONTROL SYSTEM. The following is a reprint of an approved test procedure:

Acceptance test procedure for the atrium smoke management system.

1. All testing shall be in the presence of a representative from the department.
2. All exhaust and supply-air systems shall be operationally balanced and tested. Complete air-balance reports shall be recorded on each piece of equipment, all exhaust inlets, and all supply outlets.
3. Each automatic initiating device shall be tripped to observe proper function. This test shall be performed on both normal and emergency power.
4. Each manual switch and override shall be tripped to observe proper function. This test shall be performed on both normal and emergency power.
5. All indicator lights shall display the appropriate detection and operating status.
6. Select a location on the first floor approximately 5 ft. outside the perimeter of the atrium opening. The location shall be acceptable to the department's representative.
7. Prepare three two-minute smoke bombs.
8. Ignite all three smoke bombs. When they become fully active, manually activate the atrium smoke-management system.
9. Observe and record the results.
10. After all smoke has been cleared, select an additional location on an upper level acceptable to the department's representative.
11. Prepare three more two-minute smoke bombs.
12. Ignite all three smoke bombs. When they become fully activated, again manually activate the atrium smoke-management system.
13. Observe and record the results.
14. Acceptable performance shall be movement of the smoke from the source into the atrium and out through exhaust at the top of the atrium. Smoke migration down the corridors shall be limited to no more than a light haze at a point 25 ft from the source. Furthermore, the balconies around the perimeter of the atrium shall maintain a smoke-free zone.
15. Upon the successful completion of these tests, a signed and dated copy of the department's acceptance shall be filed with the test records and a copy shall be maintained with the quarterly test log.
16. A copy of this acceptance test procedure and all plans, specifications, and calculations for the building shall be maintained with the quarterly test log.

A-53.11 (4) (c) *Increase in roof loads.* The following design provisions may be used to determine the increase in roof loads as required by this section.

ROOF SHAPES

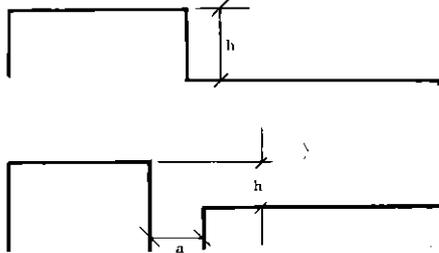

Lower level of multi-level roofs (when upper roof is part of the same building or on an adjacent building not more than 15 feet away).

SNOW LOAD DISTRIBUTIONS AND COEFFICIENTS, LIMITATIONS

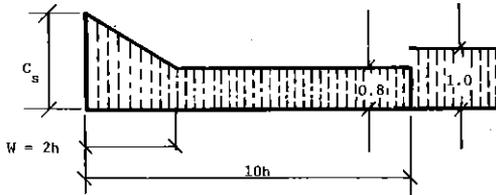

$$C_s = 15 \frac{h}{g}$$

when $15 \frac{h}{g} < 1.0$ use $C_s = 1.0$

when $15 \frac{h}{g} > 3.0$ use $C_s = 3.0^*$

$$W = 2h$$

when $h < 5$ ft use $W = 10$
when $h > 15$ ft use $W = 30$

h = difference of roof heights in ft.

g = roof live load in psf [Ind 53.11 (4)]

w = width of drift from higher building in ft.

a = distance between buildings < 15 ft.

Design upper roof for loads applicable to single-level roofs.

*An upper limit of 3 times the basic roof load has been suggested. It should be noted, however, that higher loads have been observed where an upper roof was very long (measured perpendicularly to the step between the upper and lower roofs). On the other hand, for relatively short upper roofs (say less than 50 ft), a reduction below the calculated C_s value may be judged adequate by the designer.

ROOF SHAPES

Valley areas of two-span and multi-span sloped or curved roofs

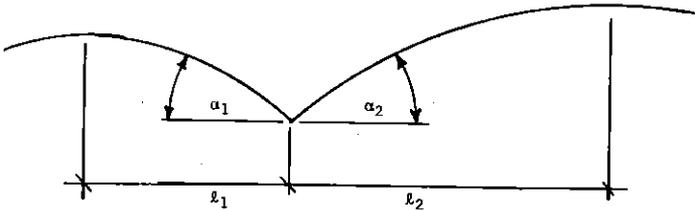
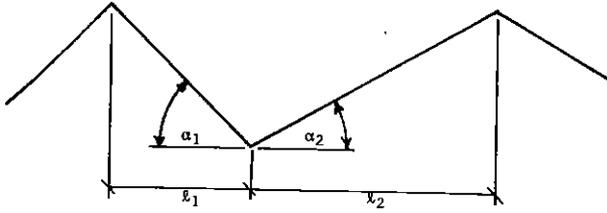

SNOW LOAD DISTRIBUTIONS AND COEFFICIENTS, LIMITATIONS

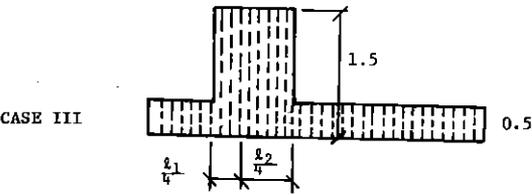
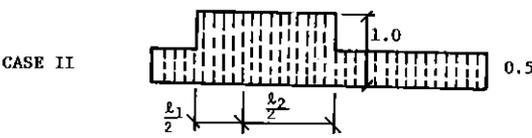
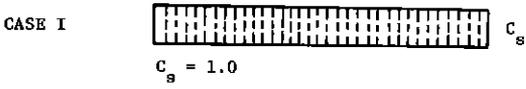

For both α_1 and $\alpha_2 \leq 10^\circ$ use Case I only; otherwise use Case I, II and III

ROOF SHAPES

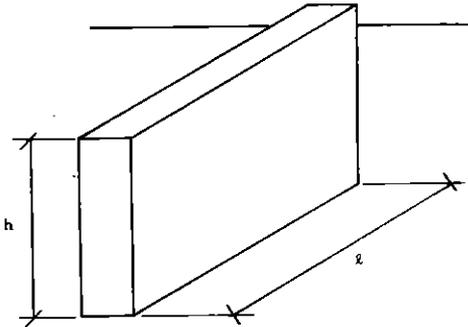

Roof areas adjacent to projections and obstructions on roofs

SNOW LOAD DISTRIBUTIONS AND COEFFICIENTS, LIMITATIONS

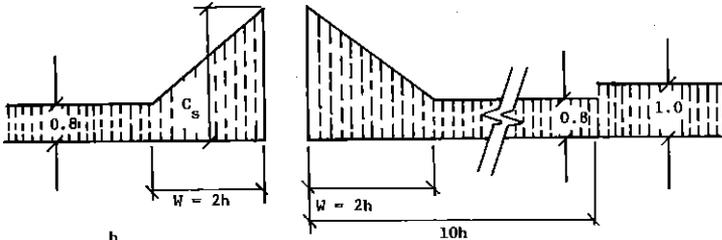

$$C_s = 10 \frac{h}{g}$$

when $10 \frac{h}{g} < 1.0$ use $C_s = 1.0$

when $10 \frac{h}{g} > 2.0$ use $C_s = 2.0$

when $l < \frac{g}{6}$ use $C_s = 1.0$

$$W = 2h$$

when $h < 5$ ft use $W = 10$

when $h > 15$ ft use $W = 30$

h = height of projection in ft.

g = roof live load in psf

w = width of snow drift in ft.

l = length of projection in ft.

ROOF SHAPES

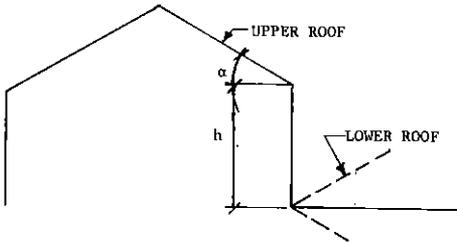

Lower of multi-level roofs with upper roof sloped towards lower roof, where α exceeds 10° .

SNOW LOAD DISTRIBUTIONS AND COEFFICIENTS, LIMITATIONS

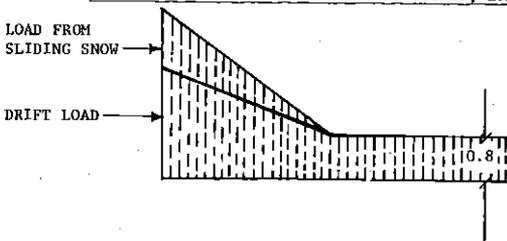

Design lower roof for loads applicable to multi-level roof plus a portion of the sliding snow from the upper roof.*

Design upper roof for loads applicable to single-level roofs.

*Where snow is likely to slide onto a lower roof from an upper roof, the lower roof should be designed for the load as provided for multi-level roofs plus an additional load produced by the snow that may slide from the upper roof. It is not possible to provide coefficients for this situation, but the following guide is recommended. Because of the remote probability that both upper and lower roofs will have their full load over the full areas simultaneously when sliding occurs, it may be assumed that the lower roof would be carrying its full load and that sliding of 50% of the total weight of the applicable uniformly distributed snow load from the upper roof would occur.

A-53.11 (4) (d) *Roof Designed for Control Flow Drainage.* This section refers to the requirements of the Plumbing Code (ch. ILHR 82) for storm drain sizes where control flow drainage roof design is used. The following information from the plumbing code is provided for use by the building designer:

Partial Reprint of s. ILHR 82.36 (4) and (5)

(4) **LOAD ON DRAIN PIPING.** (a) *Storm water drainage.* The load factor on storm water drain piping shall be computed in terms of gallons per minute or on the square footage of the horizontal projection of roofs, paved areas, yards and other tributary areas.

(b) *Continuous flow devices.* Where there is a continuous or semicontinuous discharge into the storm building drain or storm building sewer, as from a pump, air conditioning unit, or similar device, each gallon per minute of such discharge shall be computed as being equivalent to 26 square feet of roof area.

(5) **SELECTING SIZE OF STORM AND CLEAR WATER DRAIN PIPING.** (a) *Horizontal storm water drain piping.* The pipe size for horizontal drain piping for storm water shall be determined from Tables 82.36-1 to 82.36-4.

Table 82.36-1

MINIMUM SIZE OF STORM WATER HORIZONTAL DRAIN PIPING SERVING ROOF AREAS

Pipe Diameters (in inches)	Maximum Roof Areas (in square feet)			
	Pitch of Piping Per Foot			
	1/16 inch	1/8 inch	1/4 inch	1/2 inch
3	650	910	1,300	1,820
4	1,300	1,950	2,990	3,770
5	2,470	3,640	5,070	7,020
6	4,160	5,980	8,320	11,700
8	9,320	13,000	18,200	26,000
10	17,680	24,700	33,800	50,440
12	27,300	41,080	57,200	81,900
15	52,000	72,800	105,300	146,640
18	85,800	121,550	174,200	247,000
21	156,520	179,660	256,880	374,400
24	187,200	261,560	382,200	546,000

Note: Divide square footage by 26 to obtain flow in gpm.

Table 82.36-4

**MAXIMUM CAPACITY OF STORM WATER
HORIZONTAL DRAIN PIPING FLOWING FULL**

Pipe Diameters (in inches)	Maximum Capacities in Gallons Per Minute			
	Pitch of Piping Per Foot			
	1/16 inch	¼ inch	½ inch	¾ inch
3	25	35	50	70
4	50	75	115	145
5	97	140	195	270
6	160	230	320	450
8	355	500	700	1,000
10	680	950	1,300	1,940
12	1,050	1,580	2,200	3,150
15	2,000	2,800	4,050	5,640
18	3,300	4,675	6,700	9,500
21	6,020	6,910	9,880	14,400
24	7,200	10,060	14,700	21,000

(b) *Vertical conductors for storm water.* 1. A vertical conductor for storm water shall not be smaller than the largest horizontal branch connected thereto.

2. Vertical conductors shall be sized in accordance with Table 82.36-5 or the diameter D, where

$$D = 1.128 \sqrt{\frac{A}{X}}$$

Where,

A = the area of the roof in square feet

X = 300 square feet per square inch for a roof covered with gravel or slag and with a pitch not exceeding ¼ inch per foot; or

= 250 square feet per square inch for a roof covered with gravel or slag and with a pitch of greater than ¼ inch per foot; or

= 200 square feet per square inch for a roof with a metal, tile, brick or slate covering and of any pitch.

Table 82.36-5

MINIMUM DIAMETER OF VERTICAL CONDUCTORS

Type of Roof	Maximum Roof Areas (in square feet)					
	Pipe Diameters (in inches)					
	2½	3	4	5	6	8
Roofs covered with gravel, slag, or similar material and with a pitch of ¼" per foot or less.	1,645	2,120	3,780	5,885	8,490	15,125
Roofs covered with gravel, slag or similar material and with a pitch greater than ¼" per foot.	1,220	1,770	3,150	4,905	7,075	12,600
Roofs covered with metal, tile, brick, slate or similar material and of any pitch.	975	1,415	2,520	3,925	5,660	10,080

Note: Divide square footage by 26 to obtain flow in gpm.

A-53.15 LOAD COMBINATIONS. It is the intent of this section that the loads specified in ss. ILHR 53.10 through 53.14 be considered to act in the following combinations, whichever is critical, for the design of the building frame, foundation or structural member:

1. Dead load plus live load.
2. Dead load plus wind load.
3. Dead load plus live load plus wind load.
4. Dead load plus live load plus crane loads.

Distribution of live loads which would cause the maximum shear, bending moment or stress in structural members should be investigated.

A-53.64 WOOD FOUNDATIONS. The following illustrations are provided to give visual aid to the limitations specified in this rule and to indicate the three typical designs permitted by the rule.

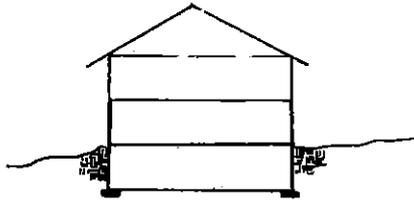

Two-story with full basement

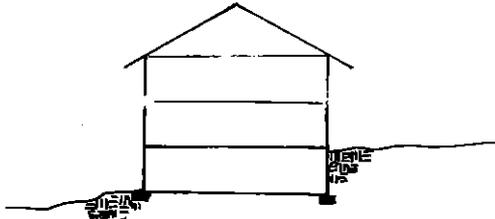

Two-story with ground floor

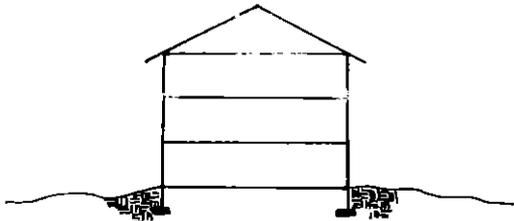

Three-story with wood foundation
(No basement or crawl space)

Appendix A

A-54.02 (4). EXIT DISTANCE. The following illustrations and text are provided to explain the procedure and intent of using the triangulation method of exit distance determination.

Exit travel must terminate at one of the following types of exits:

1. Standard exit to grade (Ind 51.15)
2. Enclosed stairways (Ind 51.17 and 51.18)
3. Horizontal exits (Ind 51.19)
4. Fire escapes (Ind 51.20)

Therefore, exit distance must be measured from one of these exit types. All exits must lead to a street, alley or open court which is connected to a street or alley.

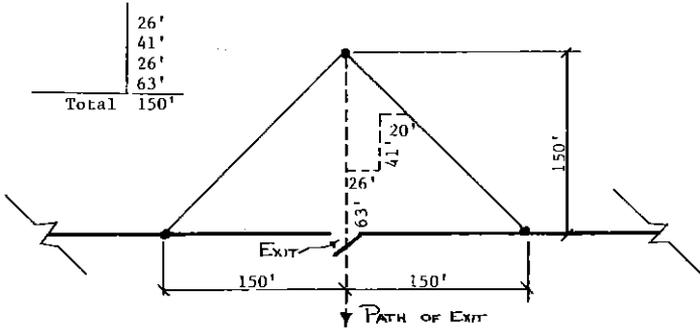

Procedure:

1. Beginning at designated exit type, measure required exit distance (100 feet, for example) at right angles to and parallel with (on both sides) the exit.
2. Connect end points to form the "exit triangle."
3. All areas within the triangle are within the required exit distance when traveling toward or at right angles to the exit.
4. All the interior space of a building must fall within the "exit triangles" formed by using the required exits for the building.
5. When measuring exit distance in stairways, only the horizontal travel distance is included in the determination.

A-57.02 (2) (b) VERTICAL DIVISION WALLS. See drawings and illustrations in s. A 51.03 (5) (a) for typical floor/ceiling-wall connection details for vertical division walls. Disregard masonry components shown in drawings when masonry is not used in the construction of the vertical division wall.

A-57.07 (3) CHANGES OF ELEVATION WITHIN INDIVIDUAL LIVING UNITS. Section ILHR 57.07 (3) permits the steps, stairs and ramps within individual living units to conform with s. ILHR 21.04 of the Uniform Dwelling Code. The following is a reprint of the applicable portions of that section:

ILHR 21.04 Stairs. Every exterior or interior stairs shall conform to the requirements of this section.

(1) **LANDINGS.** (a) *Intermediate landings.* Intermediate landings located in a flight of stairs shall be at least as wide as the stairs and shall measure at least 3 feet in the direction of travel. Trim and handrails may project no more than 3½ inches into the required width.

(b) *Landings at the top and base of stairs.* A level landing shall be provided at the top and at the foot of every stairs. The landing shall be at least as wide as the stairs and shall measure at least 3 feet in the direction of travel.

(c) *Doors at landings.* Where a door is provided at the head or foot of a stairs, a level landing on each side of the door shall be provided between the door and the stairs, regardless of the door swing.

1. Exception. A landing shall not be required between the door and the head of interior stairs within a dwelling unit, provided the door does not swing over the stairs.

2. Exception. A storm door or screen door shall be permitted to swing over an exterior platform or sidewalk provided the platform or sidewalk is located not more than 8¼ inches below the door sill and provided the platform has a length at least equal to the width of the door.

(2) **HANDRAILS AND GUARDRAILS.** (a) *Handrails.* Every stairs of more than 3 risers shall be provided with at least one handrail. Handrails shall be provided on all open sides of stairways.

(b) *Guardrails.* All openings between floors, open sides of landings, platforms, balconies or porches which are more than 24 inches above grade or a floor, shall be protected with guardrails.

(c) *Handrail and guardrail details.* 1. Height. Handrails shall be located at least 30 inches, but not more than 34 inches, above the nosing of the treads. Guardrails shall be located at least 36 inches above the upper surface of the floor.

2. Open railings. Open guardrails or handrails shall be provided with intermediate rails or an ornamental pattern to prevent the passage of a sphere with a diameter larger than 9 inches.

3. Clearance. The clearance between the handrail and the wall surface shall be at least 1½ inches.

4. Loading. Handrails and guardrails shall be designed and constructed to withstand a 200 pound load applied in any direction.

5. Exterior rails. Exterior handrails and guardrails shall be constructed of metal, decay resistant or pressure treated wood or shall be protected from the weather.

(3) **STAIR DETAILS.** Stairs shall meet the following requirements:

(a) *Minimum width.* Every stairs shall measure at least 3 feet in width.

(b) *Headroom.* Every stairs shall be provided with a minimum headroom clearance of 6 feet 4 inches. The minimum clearance shall be measured vertically from a line parallel to the nosing of the treads to the ceiling or soffit directly above that line.

(3) **TREADS AND RISERS.** Risers shall not exceed 8 inches in height, measured vertically from tread to tread. Treads shall be at least 9 inches wide, measured horizontally from nosing to nosing. There shall be no variation in uniformity exceeding 3/16 inch in the width of tread or in the height of risers. No flight of stairs shall exceed 12 feet in height unless landings are provided.

(d) *Winders.* Winder steps may be used in stairs where the length of the tread is at least 3 feet and the winder tread measures at least 7 inches in width from nosing to nosing at a point one foot from the narrow end of the tread.

(e) *Spiral stairs.* Spiral stairs may be used as an exit stairs. The tread shall measure at least 26 inches from the outer edge of the supporting column to the inner edge of the handrail and at least 7 inches in width from nosing to nosing at a point one foot from the narrow end of the tread.

A-57.11 The intent of this section is to apply to floor levels not more than one story below grade (at building).

Appendix A

A-57.11 (1) (f) It is the intent of this subsection that each living unit needs only one means of exit from within the unit and that the entire building be provided with no less than 2 exits.

A-59.14 (2) (c) *Exit distance.* See the information and illustration contained in A-54.02 (4).

A-60.19 (4) The standard is available from the National Fire Protection Association, Batterymarch Park, Quincy, Massachusetts 02269.

A-60.24 Class A fires are fires in ordinary combustible materials such as wood, cloth, paper, rubber, and many plastics. Class B fires are fires in flammable liquids, gases and greases.

A-60.35 See A-60.24.

A-60.36 (1) (a). See A-60.19 (4).

A-62.25 (1) **CLEARANCE LIMITATIONS.** The intent is to require the minimum 7 feet 0 inches clearance only in traffic lanes and in all areas normally used by the public to leave from and return to their vehicles.

A-62.50 **FIRE EXTINGUISHERS.** See A-51.22 for related information

A-63.41 **FORM.** Copies of the following form (SBD 5315) are available from the Division of Safety and Buildings, P.O. Box 7969, Madison, Wisconsin 53707. This form may be used to verify compliance with the illumination requirements of this section.

NOTES AND INSTRUCTIONS

1. Fixture schedules must accompany this form, or be shown on the plans, or in the specifications. If this form is used in lieu of illumination plans, four copies of the form shall be submitted.
2. A completed SB 118, *Plans Approval Application Form*, must accompany these calculations if they are submitted separately from the building plans.
3. The first sheet of this form must be signed and sealed by a Wisconsin registered architect, engineer or electrical designer if the total building volume is greater than 50,000 cubic feet.
4. All electric discharge lighting must meet the minimum power factor requirements of Ind 63.40.
5. Use of form:
 - A. Calculations are on an individual room or area basis.
 - B. Enter room or area designation in column (1). This shall correspond to the designations shown on the building plans.
 - C. Calculate the floor area, in Sq. Ft., of the room or area. Enter area in column (2).
 - D. Determine the allowable "Watts per Sq. Ft." from Ind 63.41. Enter this value in column (3).
 - E. Multiply value in column (2) times value in column (3). Enter product in column (4).
 - F. Enter fixture type(s) from fixture schedule in column (5).
 - G. Enter number of fixtures of each type, located in the room or area, in column (6).
 - H. Enter the wattage for one fixture of that type in column (7).
 - I. Multiply value in column (6) by value in column (7). Enter product in column (8).
 - J. Total columns (4) and (8), entering sheet totals at the bottom of each sheet, and the total of all sheets at the bottom of the final sheet.
 - K. Column (8) building total must be less than, or equal to, the building total in column (4).

A-64.20. EQUIPMENT RATINGS AND SAFETY CONTROLS. The department recognizes the following reference standards for the testing and installation of heating and ventilating equipment:

- (1) American National Standards Institute, Inc., 1430 Broadway, New York, N.Y. 10018:
 - (a) GAS-FIRED ROOM HEATERS, Vol. 1, ANSI Z21.11.1;
 - (b) GAS-FIRED LOW PRESSURE STEAM AND HOT WATER BOILERS, ANSI Z21.13;
 - (c) GAS UNIT HEATERS, ANSI Z21.16;
 - (d) DOMESTIC GAS CONVERSION BURNERS, ANSI Z21.17;
 - (e) GAS APPLIANCE PRESSURE REGULATORS, ANSI Z21.18;
 - (f) AUTOMATIC GAS IGNITION SYSTEMS AND COMPONENTS, ANSI Z21.20;
 - (g) AUTOMATIC GAS VALVES, ANSI Z21.21;
 - (h) RELIEF VALVES AND AUTOMATIC GASSHUTOFF DEVICES FOR HOT WATER SYSTEMS, ANSI Z21.22;
 - (i) GAS APPLIANCE THERMOSTATS, ANSI Z21.23;
 - (j) GAS-FIRED DUCT FURNACES, ANSI Z21.34;
 - (k) GAS FILTERS ON APPLIANCES, ANSI Z21.35;
 - (l) GAS-FIRED GRAVITY AND FAN TYPE DIRECT VENT WALL FURNACES, ANSI Z21.44;
 - (m) GAS-FIRED GRAVITY AND FORCED AIR CENTRAL FURNACES, ANSI Z21.47;
 - (n) GAS-FIRED GRAVITY AND FAN TYPE FLOOR FURNACES, ANSI Z21.48;
 - (o) GAS-FIRED GRAVITY AND FAN TYPE VENTED WALL FURNACES, ANSI Z21.49;
 - (p) VENTED DECORATIVE GAS APPLIANCES, ANSI Z21.50;
 - (q) GAS-FIRED SINGLE FIREBOX BOILERS, ANSI Z21.52;
 - (r) GAS-FIRED HIGH PRESSURE STEAM AND HOT WATER BOILERS (Inputs not over 400,000 Btu/hour), ANSI Z21.59;
 - (s) DECORATIVE GAS APPLIANCES FOR INSTALLATION IN VENTED FIREPLACES, ANSI Z21.60;
 - (t) DIRECT GAS-FIRED MAKE-UP AIR HEATERS, ANSI Z83.4;
 - (u) GAS-FIRED HEAVY DUTY FORCED AIR HEATERS, ANSI Z83.5; and
 - (v) GAS-FIRED INFRARED HEATERS, ANSI Z83.6.
- (2) Canadian Standards Association, Certification Division, Rexdale, Ontario Canada, M9W 1R3;
 - (a) Solid-Fuel Fired Appliances for Residential Use, CSAB 366M.
- (3) Energy Testing Laboratory of Maine, South Maine Vocational Technical Institute, South Portland, Maine 04106.
 - (a) Testing for Safety—Requirements and Test Procedures for Solid-Fuel Burning Central Heating Appliances and Combination Oil- and Solid-Fuel Burning Central Heating Appliances, ETLM Standard #78-1.
- (4) International Conference of Building Officials, Inc., 5360 South Workman Mill Road, Whittier, California 90601:
 - (a) Research Committee Acceptance Criteria for Fireplace Heat Exchangers.
- (5) Underwriters' Laboratories, Inc., 207 East Ohio Street, Chicago, Illinois 60611:
 - (a) CHIMNEYS, FACTORY-BUILT, RESIDENTIAL TYPE AND BUILDING HEATING APPLIANCES, UL 103;
 - (b) FACTORY BUILT FIREPLACES, UL 127;
 - (c) OIL BURNERS, UL 296;
 - (d) CONTROLS, PRIMARY SAFETY FOR GAS- AND OIL-FIRED APPLIANCES, UL 372;
 - (e) SOLID-FUEL FIRED CENTRAL FURNACES, UL 391;
 - (f) GAS VENTS, UL 441;
 - (g) HEATING APPLIANCES, ELECTRIC, UL 499;
 - (h) HEAT PUMPS, UL 659;
 - (i) TYPE L LOW-TEMPERATURE VENTING SYSTEMS, UL 641;
 - (j) OIL-FIRED BOILER ASSEMBLIES, UL 726;
 - (k) OIL-FIRED CENTRAL FURNACES, UL 727;
 - (l) OIL-FIRED FLOOR FURNACES, UL 729;
 - (m) OIL-FIRED WALL FURNACES, UL 730;
 - (n) OIL-FIRED UNIT HEATERS, UL 731;
 - (o) HEATERS, AIR AND DIRECT-FIRED HEATERS, OIL-FIRED, UL 733;
 - (p) FIREPLACE STOVES, UL 737;

Appendix A

- (q) COMMERCIAL-INDUSTRIAL GAS HEATING EQUIPMENT (Inputs over 400,000 Btu/hour), UL 796;
- (r) HEATERS, ELECTRIC, FOR USE IN HAZARDOUS LOCATIONS; Class I, Groups A, B, C and D, and Class II, Groups E, F and G, UL 823;
- (s) ELECTRIC BOILERS, UL 834;
- (t) HEATERS, ELECTRIC DRY BATH, UL 875;
- (u) FAN COIL UNITS AND ROOM FAN HEATER UNITS, UL 883;
- (v) OIL-BURNING STOVES, UL 896;
- (w) HEATERS, ELECTRIC AIR, UL 1025;
- (x) HEATING EQUIPMENT, ELECTRIC BASEBOARD, UL 1042;
- (y) HEATING EQUIPMENT, ELECTRIC CENTRAL AIR, UL 1096; and
- (z) ROOM HEATERS, SOLID-FUEL TYPE, UL 1482.

Note: The table on the following page is a tabular summary of UL 296 and UL 795.

TABULAR SUMMARY UL STANDARD 296 AND UL STANDARD 795

FUNCTION/BURNER INPUTS	OIL BURNERS UL 296				COMMERCIAL/INDUSTRIAL GAS UL 795					ATM Draft
	3 GPH	7 GPH	20 GPH	Over 20 GPH	Mechanical Draft Burners					
	400,000 Btu or less	1 million Btu or less	3 million Btu or less	3 million Btu	Over 400,000 to 2,500,000	Over 2,500,000 to 5,000,000	Over 5,000,000 to 12,500,000	Over 12,500,000		
Purge timing	--	--	--	--	4	4	4	4	90 sec ³	
Air changes	--	--	--	--	4	4	4	4	--	
Interlock Controls (Recycle)	Yes ₈	Yes ₈	Yes ₈	Yes ₈	Yes	Yes	Yes	Yes	Yes	
Proven combustion air	Yes	Yes	Yes	Yes	Yes	Yes	Yes	Yes	--	
Valve seal overtravel ⁹	--	--	--	--	--	Optional	Yes	Yes	13	
Low gas pressure	--	--	--	--	--	Yes ²⁰	Yes ²⁰	Yes ²⁰	13	
High gas pressure	--	--	--	--	--	Yes ²⁰	Yes ²⁰	Yes ²⁰	13	
Low fire start	11	11	11	11	11	11	11	11	13	
High limit (press. or temp.)	Yes	Yes	Yes	Yes	Yes	Yes	Yes	Yes	Yes	
Low water cutoff	Boilers ²¹	Boilers ²¹	Boilers ²¹	Boilers ²¹	Boilers	Boilers	Boilers	Boilers	13	
Pilot - Intermittent	Optional ¹⁹	Optional ¹⁹	Optional ¹⁹	--	Optional	Optional	Optional	Optional	12	
Pilot - Interrupted	Yes	Yes	Yes	Yes ⁵	Optional	Optional ²	Optional ²	Optional ²	2, 10	
Direct spark ignition	Yes	Yes	Yes	5	--	--	--	--	--	
System & sequence approved safety control	Yes	Yes	Yes	Yes	Yes	Yes	Yes	Yes	Yes	
Approved safety shutoff valves (SSOV)	IN	BURNER	DESIGN	--	Yes ¹⁴	Yes ¹⁴	Yes ¹⁴	Yes ¹⁴	Yes ^{13, 14}	
No vent valve	--	--	--	--	--	--	--	--	13	
Pilot valve	18	18	18	Yes	Yes ⁵	Yes	Yes	Yes	Yes	
Proved pilot	Optional	Optional	Optional	Yes	Yes	Yes	Yes	Yes	Yes	
Trial for pilot	17	17	17	15 sec	15 sec	10 sec	10 sec	10 sec	13	
Trial for main flame	90 sec ^{2, 17}	30 sec ^{2, 17}	15 sec ^{2, 17}	10/30 sec ⁷	15 sec ^{2, 22}	10 sec	10 sec	10 sec	13	
Flame failure response time	90 sec ¹⁷	4 sec max ^{16, 17}	4 sec max ^{15, 17}	4 sec max	4 sec max	4 sec max	4 sec max	2 sec max	13	
Valve closing time (max.)	23	23	23	23	5 sec max	1 sec max	1 sec max	1 sec max	13	
Supervise main flame	17	17	17	Yes	--	Yes ²	Yes ²	Yes ²	2, 10	
Action on flame failure	Recycle optional ¹	1	1	Lockout or recycle	Lockout or recycle ⁶	Lockout	Lockout	Lockout	13	
Action on limit open	Close SSOV	Close SSOV	Close SSOV	Close SSOV	Close SSOV	Close SSOV	Close SSOV	Close SSOV	13	

See following page for footnotes.

Appendix A

FOOTNOTES TO TABULAR SUMMARY UL
STANDARD 296 AND UL STANDARD 796:

SSOV = Safety shutoff valve.

- ¹May relight if ignition is re-energized within 0.8 sec. See 15 and 16.
- ²Where intermittent pilot is desired, it is allowable to switch from pilot detector to main flame detector if main flame detector responds to main flame only.
- ³Without shutters, no prepurge required.
- ⁴Options (whichever is chosen, a minimum of 4 air changes must be provided): 30 sec at high fire rate; OR
60 sec at $\frac{1}{2}$ high fire rate; OR
90 sec at $\frac{1}{4}$ high fire rate.
- ⁵With 2-stage lightoff, direct ignition is permitted if first stage is 20 gph or less (requirements for 20 gph or less apply). Pilot is required if igniting more than 20 gph.
- ⁶Lockout on interrupted pilot applications; recycle on intermittent pilot applications.
- ⁷10 sec for distillate fuel (No. 1 or No. 2); 30 sec for residual fuel (No. 4, 5, 6).
- ⁸Conventional type pressure burner—none needed. Needed for applications with combustion air supply separate from oil supply.
- ⁹Valve seal overtravel switch can be wired into either the start circuit or pre-ignition interlock circuit (if provided).
- ¹⁰Interrupted pilot over 2.5 million Btuh if modulating or high/low firing rate. Otherwise over 5 million Btuh.
- ¹¹If low fire start is not proved, UL will test for smooth lightoff at high fire.
- ¹²Intermittent up to 5 million Btuh unless firing rate control is over 2,500,000 Btuh.
- ¹³Requirements same as mechanical draft burners.
- ¹⁴See Table 1 at end of footnotes for main gas valves.
- ¹⁵Up to 15 sec is permitted if intermittent ignition is employed, or if the ignition system is re-energized in not more than 0.8 sec after flame is extinguished.
- ¹⁶Up to 30 sec is permitted if intermittent ignition is employed, or if the ignition system is re-energized in not more than 0.8 sec after flame is extinguished.
- ¹⁷If proved pilot igniter is used, timings for over 20 gal flame safeguard control may be applied.
- ¹⁸Required for electrically ignited, gas-piloted systems.
- ¹⁹Interrupted pilot may be required if using flame safeguard control with a proved pilot. Otherwise, interrupted pilot is optional.
- ²⁰Safety shutdown by this limit can be accomplished either by manual reset limits or in the programmer limit circuit.
- ²¹Required on boilers fired by oil burners—not a requirement of UL 296.
- ²²If intermittent pilot is used, no main burner flame-establishing period is required.
- ²³If a separate oil valve is used, it must close within 5 sec max when de-energized.

TABLE 1—AUTOMATIC MAIN GAS SAFETY SHUTOFF VALVES (SSOV) FOR MECHANICAL OR ATMOSPHERIC BURNERS—UL 796 REQUIREMENTS, EFFECTIVE OCTOBER 1, 1974

	400,000 to 2,500,000 BTUH	Over 2,500,000 to 5,000,000 BTUH	Over 5,000,000 to 12,500,000 BTUH	Over 12,500,000 BTUH
Main Valve Requirement	One valve rated for safety shutoff services (SSOV). Closing time 5 sec.	Two SSOV's in series, or one SSOV of the type incorporating a valve seal overtravel interlock. Closing time 1 sec max.	Two SSOV's in series, one of which incorporates a valve seal overtravel interlock. Closing time 1 sec max.	Two SSOV's in series, one of which incorporates a valve seal overtravel interlock. When fuel gas has specific gravity of less than 1.0, include a N.O. ¼ inch or larger electrically operated valve in a vent line between the two SSOV's.

APPENDIX B

The material contained in this appendix is for clarification purposes only. The information is for the benefit of fire department inspectors making inspections pursuant to s. 101.14 (2) (b), Stats. (See s. ILHR 50.02 Special Note #2)

Rule Number	Topic of Rule	Subject of Investigation
Ch. ILHR 50—Administration and Enforcement		
50.25	Petition for Variance	1. Fire Department Position Statement (form SB-8A)
Ch. ILHR 51—Definitions and Standards		
51.047	Fire Rated Door Assemblies in Fire Rated Construction	1. Maintenance 2. Operation 3. Unobstructed
51.047 (6)	Door Closing Devices (Fire Doors)	1. Maintenance 2. Use of Fusible Link
51.06 (3)	Foam Plastics (Thermal Barrier)	1. Proper Type and Correct Installation 2. Maintenance
51.15 (2)	Exit Doors	1. Maintenance 2. Unobstructed
51.15 (3)	Exit Hardware	1. Proper Type 2. Signage 3. Security Locks and Key Locks Open During Occupied Periods
51.15 (4)	Exit Doorway	1. Proper Size and Type 2. Maintenance
51.16 (5) (c)	Stairways and Ramps	1. Area Beneath Stairways and Ramps
51.161	Handrails	1. Maintenance 2. Replacement, when Needed
51.162	Guardrails	1. Maintenance 2. Replacement, when Needed
51.165	Stairway Identification	1. Proper Posting 2. Proper Signage on Buildings Constructed After January 1, 1982
51.166	Stairway Discharge	1. Proper Type 2. Maintenance
51.167	Exiting Through Areas of Hazard	1. Proper Type
51.20	Fire Escapes	1. Maintenance
51.21	Standpipe & Hose Systems	1. Correct Installation 2. Maintenance
51.22	Fire Extinguishers	1. Proper Type 2. Location 3. Maintenance 4. Operational

Rule Number	Topic of Rule	Subject of Investigation
51.23	Automatic Sprinklers	1. Water Supply 2. Obstruction of Sprinkler Heads 3. Location of Fire Department Connection 4. Accessibility of Fire Department Connection
51.24 (5)	Fire Alarm Systems	1. Operation & Testing 2. Location of Pull Stations
51.245	Smoke Detectors	1. Correct Installation 2. Maintenance of Detectors 3. Operational
Ch. ILHR 52—General Requirements		
52.01	Fire Prevention, Detection and Suppression (High Rise Construction)	1. Proper Installation 2. Maintenance 3. Operation and Testing
52.015	Automatic Fire Sprinkler Systems for Low Rise Buildings	1. Proper Installation 2. Maintenance 3. Operation and Testing
52.02 (2)	Fire Department Access Openings	1. Proper Type, Size and Location 2. Maintenance
52.07	Atriums	1. Proper Type 2. Smoke Control System 3. Maintenance 4. Test Reports
52.19	Gas and Oil Lamps	1. Proper Type and Clearance 2. Maintenance
52.20	Electrical Work	1. Electrical Check List
52.21	Location and Maintenance of Exits	1. Maintenance
52.22	Repairs	1. Conformance
52.23	Cleanliness	1. Conformance
Ch. ILHR 53—Structural Requirements		
53.63 (1) (a)-(c)	Firestops	1. Maintenance
Ch. ILHR 54—Factory, Office, Mercantile		
54.01(3)	Fire Door Closing Devices	1. Maintenance 2. Operational
54.02	Number and Location of Exits	1. Maintenance 2. Proper Exit Hardware
54.06	Exit Doors, Exit Lights	1. Maintenance of Illumination
54.07	Passageways	1. Maintain in Clear, Unobstructed Condition
54.08	Stairway Enclosure	1. Maintenance
54.11	Lighting	1. Maintenance of Illumination
54.14	Isolation of Hazards	1. Maintenance

Rule Number	Topic of Rule	Subject of Investigation
54.145	Fire Extinguishers	1. For Buildings Constructed After January 1, 1982: A. Proper Type B. Location C. Maintenance D. Operational
54.15	Standpipes	1. Maintenance
54.17	Fire Alarm	1. Maintenance 2. Location of Pull Stations
54.20	No Smoking Signs Ch. ILHR 55—Theaters and Assembly Halls	1. Proper Posting
55.07	Number and Location of Exits	1. Maintenance of Illumination
55.08	Type of Exits	1. Maintenance 2. To be Clear and Unobstructed
55.09	Stairways	1. Maintenance 2. To be Clear and Unobstructed
55.10	Exit Doorways and Doors	1. See 51.15
55.11	Exit Lights	1. Maintenance of Illumination
55.12	Required Exit Width	1. To be Unobstructed
55.14	Width of Aisles	1. To be Unobstructed
55.15	Lobbies and Foyers	1. To be Clear and Unobstructed
55.17	Obstructions	1. Maintenance
55.22 (3)	Proscenium Wall (Openings)	1. Proper Type 2. Maintenance
55.24	Automatic Smoke Outlets	1. Operation
55.29	Isolation of Hazards	1. Maintenance of Enclosures
55.33	Standpipes	1. Correct Installation 2. Maintenance
55.34	Fire Extinguishers	1. For Buildings Constructed After January 1, 1982: A. Proper Type B. Location C. Maintenance D. Operational
55.43	Openings	1. Operational 2. Maintenance
55.45	Relief Outlets	1. Maintenance
55.46	Electric Wiring	1. Electrical Check List
55.50	Maintenance	1. Elimination of Fire Hazard

Rule Number	Topic of Rule	Subject of Investigation
Ch. ILHR 56--Schools and Places of Instruction		
56.03	Smoke Detection	1. For Existing Buildings with Basements not Protected by Automatic Sprinklers or Smoke Detectors as of January 1, 1982, Automatic Smoke Detector System in Basement Corridors by January 1, 1983. A. Correct Installation B. Maintenance of Detectors
56.06	Exit	1. Maintenance
56.06 (6)	Exit Lights	1. Maintenance of Illumination
56.07	Required Exit Width	1. To be Unobstructed
56.09	Passageways	1. To be Unobstructed 2. Maintenance of Exit Doors
56.15	Isolation of Hazards	1. Maintenance of Enclosure
56.18	Fire Extinguishers	1. Proper Type 2. Location 3. Maintenance 4. Operational
56.19	Fire Alarms	1. Operation of System 2. Location of Pull Stations
56.20	Standpipes	1. Correct Installation 2. Maintenance
56.34	Exit Doors and Lights	1. Maintenance of Doors 2. To be Clear and Unobstructed
56.38	Fire Alarms	1. Operational 2. Testing 3. Location of Pull Stations
56.43	Exit Doors and Exit Lights	1. Maintenance of Doors 2. To Be Clear and Unobstructed
56.46	Fire Alarms	1. Operational 2. Testing 3. Location of Pull Stations
Ch. ILHR 57--Residential Occupancies		
57.01 (3)	Basement and Ground Floor Protection	1. Proper Installation 2. Maintenance
57.02	Allowable Height and Area (Corridor Door Hold-Open Device, Access Roadways)	1. Maintenance 2. Operational 3. Clear and Unobstructed
57.03	Number and Location of Exits	1. Maintenance 2. Proper Exit Hardware
57.05	Type of Exits	1. Maintenance 2. To be Clear and Unobstructed 3. Proper Illumination
57.08	Enclosure of Interior Stairways and Shafts	1. Maintenance of Enclosure

Rule Number	Topic of Rule	Subject of Investigation
57.09	Passageways	1. To Be Clear and Unobstructed 2. Maintenance of Exit Doors
57.10	Illumination of Exits and Exit Signs	1. Maintenance of Illumination and Signs
57.14	Isolation of Hazards	1. Maintenance of Enclosure
57.15	Standpipes	1. Correction Installation 2. Maintenance
57.16	Smoke Detectors - All Buildings Except CBRF	1. For Existing Buildings Constructed Before May 23, 1978, Specified Smoke Detectors by January 1, 1983. A. Correct Installation B. Maintenance of Detectors 2. For Buildings Constructed After January 1, 1983: A. Correction Installation B. Maintenance of Detectors C. Interconnection of Corridor/Stairway Detectors to Required Manual Fire Alarm System D. Corridor/Stairway Smoke Detectors Provided with Emergency Power, if Required for the Building
57.165	Smoke Detectors — CBRF	1. Correct Installation 2. Maintenance of Detectors 3. Interconnection of Stairway, Complete Corridor and Common Use Room Detectors 4. Interconnection of Sleeping Room Detectors if Smoking is Permitted
57.17	Fire Alarms	1. Operation of Systems 2. Location of Pull Stations
57.18	Fire Extinguishers	1. For Buildings Constructed After January 1, 1982: A. Proper Type B. Location C. Maintenance D. Operational
57.19	Rowhouse (Living Unit Separation)	1. Proper Installation 2. Maintenance
Ch. ILHR 58—Health Care Facilities		
58.04-58.05	Number, Type and Location of Exits	1. Maintenance 2. Proper Exit Hardware
58.06	Stairs	1. Maintenance 2. To Be Clear and Unobstructed 3. Proper Illumination.
58.18	Marking of Means of Egress	1. Correct Signage 2. Proper Illumination

Rule Number	Topic of Rule	Subject of Investigation
58.20	Key Locking Hardware	1. Correct Hardware Type and Installation 2. Building Satisfies Rules for Detention and Correctional Facilities 3. Maintenance
58.21-58.23	Protection of Openings	1. Maintenance
58.24	Isolation of Hazards	1. Maintenance of Enclosure and Required Automatic Sprinkler System
58.25	Rubbish Chutes and Laundry Chutes	1. Protection of Enclosure 2. Sprinkler System Maintenance
58.27	Detection, Alarm and Communication Systems	1. Operational 2. Testing 3. Location of Pull Stations 4. Correct Installation 5. Maintenance
58.28	Standpipes	1. Correct Installation 2. Maintenance
58.29	Automatic Sprinkler and Other Suppression Systems	1. Water Supply 2. Obstruction of Sprinkler Heads 3. Location and Accessibility of Fire Department Connection
58.30-58.31	Smoke Barriers, Corridor Walls	1. Correct Installation 2. Maintenance
Ch. II,HR 58—Places of Detention		
58.48-58.49	Number, Type and Location of Exits	1. Maintenance 2. Proper Exit Hardware
58.50-58.51	Stairways and Smokeproof Towers	1. Maintenance 2. To Be Clear and Unobstructed 3. Proper Illumination
58.575	Emergency Lighting	1. Proper Type 2. Maintenance
58.58	Marking of Means of Egress	1. Correct Signage 2. Proper Illumination
58.59	Door Locks	1. Correct Type and Installation 2. Maintenance
58.60-58.61	Protection of Openings	1. Maintenance
58.62	Isolation of Hazards	1. Maintenance of Enclosure
58.63	Standpipes	1. Correct Installation 2. Maintenance
58.635	Fire Extinguishers	1. Proper Type 2. Location 3. Maintenance 4. Operational
58.64	Fire Alarms	1. Operation of System 2. Location of Pull Stations

Rule Number	Topic of Rule	Subject of Investigation
58.65	Automatic Smoke Detection Systems	1. Correct Installation 2. Maintenance of Detectors
58.67	Smoke Barrier	1. Correct Installation 2. Maintenance
Ch. ILHR 59—Hazardous Occupancies		
59.13	Type of Exits	1. Maintenance 2. Proper Exit Hardware
59.14	Number and Type of Exits	1. Maintenance 2. To Be Clear and Unobstructed
59.17	Enclosure of Stairways and Shafts	1. Maintenance of Enclosures
59.19	Illumination Levels	1. Proper Illumination
59.21	Isolation of Hazards	1. Maintenance of Enclosures
59.23	Fire Protection	1. Operation of System 2. Proper Type of Extinguisher 3. Location of Extinguisher 4. Extinguisher Operational 5. Water Supply 6. Obstruction of Sprinkler Heads 7. Location and Accessibility of Fire Department Connection 8. Maintenance of Systems
59.24	Fire Alarms	1. Operation and Testing 2. Location of Pull Stations
Ch. ILHR 60—Child Day Care Facilities		
60.12	Doors	1. Joint Inspection Made
60.16	Electrical Work	1. Electrical Check List
60.19	Operating Features	1. Owner Responsibility
60.21	Exiting	1. Joint Inspection Made
60.22	Passageways	1. To be Cleared and Unobstructed 2. Maintenance
60.23	Stair & Shaft Enclosure	1. Joint Inspection Made
60.24	Fire Extinguisher	1. Proper Type 2. Location 3. Maintenance 4. Operational
60.25	Hazardous Areas	1. Joint Inspection Made
60.31	Exiting	1. Joint Inspection Made
60.32	Required Exit Width	1. Width to be Unobstructed
60.33	Passageways	1. Joint Inspection Made
60.34	Stair and Shaft Enclosure	1. Joint Inspection Made
60.35	Fire Extinguisher	1. Proper Type 2. Location 3. Maintenance 4. Operational

Rule Number	Topic of Rule	Subject of Investigation
60.36	Fire Alarm System	1. Operation and Testing 2. Location of Pull Station
60.37	Hazardous Areas	1. Joint Inspection Made
60.38	Exit and Emergency Lighting	1. Joint Inspection Made
Ch. ILHR 61—Community-Based Residential Facilities		
61.10 (1) (h)	Construction, Building and Site	1. Maintenance
61.10 (3)	Smoke Separation	1. Maintenance
61.12	Exiting and Doors	1. To be Clear and Unobstructed 2. Maintenance
61.14	Smoke Detection	1. Correct Installation 2. Maintenance of Detectors
61.18 (4)	Ramp Requirements	1. Maintenance
61.20	Fire Extinguisher	1. Proper Type 2. Location 3. Maintenance 4. Operational
61.24	Heating and Ventilating	1. Maintenance
61.25	Electrical	1. Electrical Check List
Ch. ILHR 62-Subch. I—Open Parking Structures		
62.26	Number, Location and Type of Pedestrian Exits	1. Maintenance
62.29	Illumination and Exit Lights	1. Maintenance of Illumination and Exit Lights
62.30	Fire Protection	1. Correct Installation of Standpipes
62.32	Isolation of Hazards	1. Maintenance
Ch. ILHR 62-Subch. III—Tents		
62.46	Fire Hazards	1. Elimination of Fire Hazard
62.47	Exits	1. Maintenance
62.49	Electrical Installation	1. Proper Installation
62.50	Fire Extinguishing Equipment	1. Proper Type 2. Location 3. Maintenance 4. Operational
62.51	Illumination, Exit Lights and Signs	1. Maintenance of Illumination
Ch. ILHR 62-Subch. V—Assembly Seating Facilities		
62.72	Inspection and Maintenance	1. Proper Maintenance 2. Conformance With Rules
62.75	Means of Egress	1. Maintenance 2. To Be Clear and Unobstructed
62.78	Isolation of Hazards	1. Maintenance of Enclosure
62.80	Illumination and Emergency Lighting	1. Proper Illumination

Rule Number	Topic of Rule	Subject of Investigation
62.81	Fire Prevention	1. Maintenance
Ch. ILHR 62—Subch. VII—Pedestrian Access Structures Connecting Buildings		
62.98	General Requirements Construction	1. Protection of Openings 2. Maintenance
62.99	Exiting	1. Maintenance 2. To Be Clear and Unobstructed
Ch. ILHR 64—HVAC		
64.08	Exhaust Ventilation System	1. Maintenance
64.09	Combustion Air Intakes	1. Maintenance
64.16	Air Cleansing Devices	1. Maintenance
64.19	Location of Outside Air Intakes and Exhausts for Mechanical Ventilating Systems	1. Maintenance
64.21	Location of Equipment	1. Proper Equipment 2. Maintenance
64.22(5)	Unvented Space Heaters	1. Use Prohibited
64.22 (7)	Fireplaces and Fireplace Stoves	1. Proper Installation 2. Maintenance 3. Operation and Testing
64.23 (5) (a) and (b)	Piping	1. Installation 2. Maintenance
64.42	Fire Dampers and Fire Curtains	1. Maintenance
64.45	Chimneys, Smoke Stacks, Gas Vents, Mechanical Draft and Venting Devices	1. Maintenance
64.46	Masonry Chimneys	1. Maintenance
64.47	Metal Smokestacks	1. Maintenance
64.48	Factory-Built Chimneys and Gas Vents	1. Maintenance
64.49	Gas Vent	1. Maintenance
64.50	Chimney and Vent Connectors	1. Maintenance
64.51 (4)	Fire Protection	1. Correct Equipment 2. Proper Installation 3. Proper Clearances and Protection
64.52(1)	Maintenance	1. Inspection of Chimney After Fire Before Reuse
64.61(2)	Repair Areas	1. Maintenance
64.62 (2)	Vehicle Service Buildings	1. Maintenance
64.63 (2)	Garages	1. Maintenance
64.67 (5) (e), (f) and (g)	Kitchens	1. Maintenance

Rule Number	Topic of Rule	Subject of Investigation
64.67 (6)	Automatic Suppression Systems	1. Correct System 2. Proper Installation 3. Maintenance and Operational

See s. ILHR 50.02—Special Note #2

INDEX

See also first page of each chapter for listing of section headings.

Note: An asterisk (*) following a subject reference indicates further requirements will be found in the "occupancy chapters" of the code—chs. ILHR 54 through 62.

A

	<u>ILHR Section No(s).</u>
ACADEMIES.....	56.001
ACCESS	
Access or accessible, for physically disabled	52.04
To panels, for fire department	52.02
To roofs	51.02
ACCESS ROADWAYS	54.01, 57.02
ACCESSIBLE CONSTRUCTION, Requirements for	52.04
ACCESSORY ROOM, Definition of	51.01
ACOUSTICAL MATERIAL	51.03, 51.07
ADDITIONS, TO EXISTING	
BUILDINGS	50.03, 50.07, 52.015, 52.04
ADJOINING BUILDINGS, Doors and windows	51.03
ADJOINING PROPERTY, Protection of	53.26
ADMINISTRATION AND ENFORCEMENT (Ch. ILHR 50)	
Additions	50.03, 50.07, 52.04
Alterations	50.03, 50.07, 50.12
Appeals.....	50.24
Application of code	50.03
Approval by certified city inspector	50.22
Approval of materials, equipment and devices	50.19
Approval of plans and specifications.....	50.12, 63.01, 64.02
Approval, revocation of	50.16
Buildings exempt from code requirements.....	50.04
Certificate of occupancy, local requirement	50.06
Change of use.....	50.03, 52.04, 63.001
Changes to plans and specifications.....	50.09, 63.001
Design	50.07
Design responsibilities.....	50.12
Enforcement	50.23
Evidence of plan approval.....	50.15
Existing buildings (also refer to chapters Ind 160-164).....	50.05
Expiration of plan approval	50.17
Fees (also refer to chapter Ind 69)	50.20
First class city examination and approval	50.21
Footing and foundation approval.....	50.13
Local regulations.....	50.06
Penalties	50.26
Permission to start construction.....	50.14
Petition for variance	50.25
Plans prepared outside Wisconsin	50.08
Right of entry on premises (refer to ch. 101, Stats.)	
Saving and severable clause	50.27

Scope of code (See also chapters ILHR 51-64)	50.02
Tests and test reports	50.19, 51.044, 64.20
AGGREGATES	
Concrete	53.40, 53.42
Fire resistance.....	51.045
Masonry mortar.....	53.312
Moisture content	53.312
AGRICULTURAL BUILDINGS, farm use exempt	50.04
AIR CONDITIONING	64.01
Definition of.....	51.01, 64.12
AIRCRAFT HANGARS	59.20, 59.23
AIR DUCTS.....	64.31, 64.45
AIR INTAKES	
Combustion equipment (solid and liquid fuels)	64.09
Fresh air	64.19
Projection booths, indoor	55.44
AIRPLANE HANGARS	59.20, 59.23
AISLES*	
ALARM SYSTEMS	51.24, 51.245, 52.01
ALLEY, Definition of	51.01
ALLEYS, Location and maintenance of	52.21
ALLOWABLE AREAS AND HEIGHT OF BUILDINGS*	51.02, 51.03, 52.015
ALLOWABLE STRESSES	53.14, 53.322, 53.323
ALTERATIONS.....	50.03, 50.07, 50.12, 52.04
ALUMINUM CONSTRUCTION	53.54
AMUSEMENT PARK	
Amusement structures (Refer to chapter ILHR 34)	
ANCHORAGE, ANCHORS	
Bolts.....	53.34
Concrete slabs on masonry (restrained)	53.322
Masonry, general	53.316, 53.322, 53.323, 53.34
Masonry, veneer	53.322, 53.36
Steel floor joists.....	53.52
Timber fasteners.....	53.322, 53.61, 53.63
Uplift and suction forces on buildings, structures, roofs	53.12
Walls and partitions, intersecting.....	53.63
Wood fasteners	53.61
Wood floor framing to masonry.....	53.322, 53.323
Wood floor joists or beams on masonry	53.322, 53.323
Wood framing around openings.....	53.63
Wood headers	53.63
Wood joist anchors	53.63
Wood nailing schedule	53.63
Wood partitions.....	53.63
Wood sill anchors.....	53.63
Wood trusses	53.12, 53.62
ANTENNA, RECEIVING, Television and Radio.....	62.35-62.41
APARTMENT BUILDINGS, HOTELS, MOTELS	57.001

Index

APARTMENTS	57.001
APPEALS.....	50.24
APPLICATION FOR PERMIT	50.13
APPROVED, Definition of	51.01
APPROVED DIVERSIFIED TESTS, Definition of	51.01, 51.06
ARCHITECT, Services of, required.....	50.07, 50.08, 50.10, 50.12
AREA (GROSS) and (NET), definitions of.....	51.01
AREAS, ALLOWABLE	
Allowable areas*	
Attic areas	51.02
Automatic sprinklers.....	52.015
Existing buildings	50.03
Increase in areas allowed when sprinklered	54.01, 57.01, 59.12
Unlimited areas.....	54.01
AREAWAY, Definition of	51.01
ARENA, HORSE	54.001 or 55.01
ARTIFICIAL STONE, Bonding	53.316
ASPHALT, Roof coverings	51.03-A, 51.05
ASSEMBLY HALLS	
Net capacity 100 persons or less.....	54.001
Net capacity more than 100 persons	55.01
ASSEMBLY SEATING FACILITIES	62.70-62.81
ATRIUM	51.01, 52.07
ATTIC	
Access	51.02, 57.19
Compartmentalization	51.02
Definition of.....	51.01
AUDITORIUMS (see ASSEMBLY HALLS)	
AUTOMATIC FIRE SPRINKLER SYSTEM,	
Definition of.....	51.01
AUTOMATIC SPRINKLERS (see SPRINKLERS AND STANDPIPES)	

B

BALCONY (EXTERIOR) and (INTERIOR), Definitions of	51.01
Exterior balcony, as exit	54.03, 57.12
Fire escapes.....	51.20
BARRIER-FREE DESIGN	52.04
BARS	
Concrete, reinforcing.....	53.316, 53.40
Panic	51.15
BASEMENT, Definition of.....	51.01
BASEMENT ROOMS*	
BATHROOM (see TOILETS)	
BEAMS (also see GIRDERS)	
Concrete design.....	53.40
Fire cuts	53.63

Fire protective and fire-resistive requirements...	51.03, 51.043, 51.045
Plywood beams	53.61
Reinforced concrete.....	53.40
Reinforced masonry	53.323
Steel.....	53.50
Structural, glue laminated	53.61
Timber, heavy	53.61
Wood.....	53.61
BEARING	
For wood beams and girders	53.34, 53.63
For wood columns.....	53.60
BEARING, SOIL CAPACITY	53.21
BEARING WALL (see MASONRY, WOOD CONSTRUCTION)	
Definition of.....	51.01
BED AND BREAKFAST ESTABLISHMENT.....	50.04, 51.01
BLEACHERS, Temporary seats.....	62.70-62.81
BLOCKS, CONCRETE MASONRY UNITS	53.311
BOILERS	64.22
BOLTS (see ANCHORAGE AND ANCHORS)	
BOND, MASONRY	
Masonry, hollow units	53.322
Masonry, solid units	53.322
Mortar.....	53.312
Reinforcement	53.316, 53.322
Veneered walls	53.36
BOWLING ALLEYS.....	54.001 or 55.01
BRACING	
Exterior stud walls.....	53.63
Masonry walls, lateral.....	53.322
Smokestacks	64.47
BRICK-CLAY, CONCRETE, ETC. (see MASONRY CONSTRUCTION)	
BRIDGING	
Joists, steel	53.50, 53.52
Joists, wood	53.63
BUILDING	
Allowable areas and heights*	51.02, 51.03, 52.015
Change of use.....	50.03, 52.015, 52.04, 63.001
Changes to building	50.03, 50.07
Classified by use or occupancy*	
Definition.....	51.01
Existing	50.05
Height, definition of	51.01
Locations	51.02, 51.03, 62.22
Maintenance	52.22, 52.64, 55.50, 61.21
New	50.03, 50.07
Pole	51.03
Temporary.....	50.04
BUILDING CODE	
Administration (see ADMINISTRATION AND ENFORCEMENT)	
Scope*.....	50.02

Index

BUILDING OFFICIAL OR APPROVING OFFICIAL (referred to in this code as the department or as the department of industry, labor and human relations [superceding the industrial commission])	
Approve alternate construction or materials	50.19
Classifies buildings	51.03
Enter premises (refer to ch. 101, Stats.)	
Inspection (also see ch. 101, Stats.).....	50.18
Order occupancy of building discontinued	50.06
Record of approvals	50.07, 53.21
Require plans and calculations by Wis. registered architect, engineer or designer	50.07, 50.08, 50.12, 64.02
Reviews plans	50.12
BUILDING OFFICIALS AUTHORIZATION REQUIRED	
Plan changes.....	50.09
Structural alterations.....	50.03
Use or occupancy changes	50.03
BUILDING PLAN APPROVAL	50.12
BUTTRESS, Definition of	51.01
C	
CAISSONS	53.24
CALCULATIONS REQUIRED	50.12, 51.046
CANOPIES	
Service stations	59.11
CAST STONE	53.311
CAVITY WALL, Definition of	51.01
CEILING PROTECTION, Definition of	51.01
CEILING S	51.03, 51.045
CELLAR (see BASEMENT)	
CEMENT (See PORTLAND CEMENT)	
CERTIFICATE OF OCCUPANCY	50.06
CERTIFIED CITIES, plans approved by	50.22
CHAIR LIFT	51.16
CHANGE OF OCCUPANCY	
(Change of use).....	50.03, 52.015, 52.04, 63.001
CHIMNEYS	64.45, 64.46, 64.48, 64.50
CHURCHES (see ASSEMBLY HALLS)	
CIRCULATION, INTERIOR	52.04
CLASSIFICATION OF BUILDINGS	
Construction classification	51.03
Occupancy classifications (see OCCUPANCY CHAPTERS)	
CLASSROOMS	
Mobile training units	56.40
Relocatable	56.30
CLEANLINESS	52.23
CLEARANCE LIMITATIONS	51.164, 62.25, 64.51

CLOSING DEVICE (FIRE DOOR), Definition of.....	51.01
CLUBS	54.001 or 55.01
CODE, SCOPE*	50.02
COLLEGES AND UNIVERSITIES	56.001
COLUMNS	
Fire protection requirements.....	51.02, 51.03, 51.045
Footings supporting	53.11
Heavy timber.....	51.03
Masonry	53.322
Reinforced concrete.....	53.40
Structural steel	53.50
Wood	53.61, 53.63
COMBUSTIBLE	
Clearance to.....	64.51
Construction, definition of	51.01
Material, definition of	51.01
Material, storage of	60.19
COMBUSTION AIR.....	64.09
COMMERCIAL MOTOR VEHICLE, Definition of	51.01
COMMUNITY-BASED RESIDENTIAL FACILITIES (CBRF)	50.04, 57.001, 61.001
COMPLIANCE.....	50.10
COMPOSITE WALLS.....	53.322
COMPOSITION ROOFING	51.05
CONCRETE	53.40-53.42
Types of.....	51.045
CONCRETE BLOCKS	53.311
CONDOMINIUMS.....	57.001
CONNECTORS, CHIMNEY & VENTS	64.50
CONSERVATION OF ENERGY.....	63.001
CONSTRUCTION	
Aluminum.....	53.54
Classes of	51.03
Concrete	53.40
Definition of.....	51.01
Masonry	51.03
Stage separation.....	55.21
Steel.....	53.50
Temporary.....	50.04
Types of.....	51.03
Wood frame	51.03
Wood framing.....	53.60
CONVALESCENT HOMES	57.001
CONVENTS.....	57.001
CORBELING MASONRY.....	53.34
CORRECTIONAL FACILITIES	58.40
CORRIDOR, Definition of.....	51.01
CORRIDORS, AS REQUIRED EXITS	51.03

Index

Definition of.....	51.01
COURT WALLS, REQUIRED FIRE-RESISTIVE.....	51.03
CURB, CUT FOR BARRIER-FREE ACCESS.....	52.04
CURTAIN, PROSCENIUM.....	55.23
CURTAIN WALL, Definition of.....	51.01

D

DAMPERS AND SHUTTERS, FIRE.....	64.42
DANCE HALLS.....	54.001 or 55.01
DAY CARE CENTERS (Ch. ILHR 60).....	60.001
DEAD LOADS.....	53.10
DECAY PREVENTION.....	53.63
DECORATIVE FEATURES	
Fire protective requirements.....	51.02
Projections.....	51.03
Wood and other combustibles.....	51.02
DEFINITIONS	
Certain words and topics.....	51.01
Occupancies (see OCCUPANCY CHAPTERS)	
Types of construction.....	51.03
DEPARTMENT, Definition of.....	51.01
DESIGN AND SUPERVISION OF CONSTRUCTION ..	50.07, 50.10
DETECTORS (see smoke detection)	
DETENTION AND CORRECTIONAL FACILITIES.....	58.40
DIAPHRAGMS, PLYWOOD.....	53.61
DIRECT VENT SEALED COMBUSTION CHAMBER APPLIANCE.....	51.01, 64.21
DISTANCE BETWEEN BUILDINGS.....	51.03
DISTRIBUTION OF EXITS.....	51.151
DIVERSIFIED TEST.....	51.06
DIVISION WALL, Definition of.....	51.01
DOORS AND DOOR ASSEMBLIES, RATED.....	51.047
Fire-resistive, when required.....	51.03
DORMITORIES.....	57.001
DRAFT STOPS.....	53.63
DRAWINGS (see ADMINISTRATION AND ENFORCEMENT)	
DRESSING ROOMS, STAGE.....	55.28
DRINKING FOUNTAINS*.....	52.04, 52.60
DRY CLEANING (refer to chapter ILHR 15)	
DUCT, Definition of.....	51.01
DUCT FURNACE, Definition of.....	51.01
DUCTS.....	64.31-64.40
DUMB WAITERS (refer to chapter Ind 4)	
DWELLINGS	
Apartments.....	57.001

One and 2-family units exempt50.04
 (also refer to Uniform Dwelling Code)

E

EARTH PRESSURE53.21, 53.24, 53.28

ECCENTRIC LOADS 53.11

ELECTRIC WELDING 53.53

ELECTRICAL WORK (see also Wis. Electrical Code) 52.20, 61.25

ELEVATORS (refer to chapter Ind 4)

ELEVATOR SHAFTS (see **VERTICAL OPENINGS**)

ENCLOSURE OF VERTICAL OPENINGS (see **STAIRS AND STAIRWAYS** and **TYPES OF CONSTRUCTION**)

ENERGY CONSERVATION (Ch. ILHR 63)

DESIGN CONDITIONS

 Design criteria 63.12

 General requirements 63.11

EQUIPMENT AND SYSTEMS

 Controls 63.21

 Cooling with outdoor air 63.23

 Equipment efficiencies 63.20

 Insulation 63.22

 Maintenance 63.24

ILLUMINATION AND ELECTRICAL SYSTEMS

 Controls 63.42

 Distribution 63.40

 Lighting 63.41

NONDEPLETABLE ENERGY SOURCES

 Documentation 63.51

 Solar, wind, geothermal and others 63.50

SCOPE AND PURPOSE

 General 63.001

 Plans and specifications 63.01

 Purpose 63.002

SYSTEMS ANALYSIS DESIGN

 Annual energy consumption 63.60

 Documentation 63.62

 Simulation 63.61

WATER HEATING

 Conservation of hot water 63.32

 Insulation 63.33

 Purpose 63.30

 Water heaters, storage tanks and boilers 63.31

ENERGY EFFICIENCY RATIOS 63.20

ENGINEER

 Design and supervision required 50.07, 50.10

 Name required on plans 50.12

EQUIPMENT, Definition of 51.01

EQUIVALENT THICKNESS, MASONRY 51.045

Index

EXCAVATIONS	53.20-53.28
(also refer to chapter Ind 1070, Safety & Health Code)	
EXHAUST VENTILATION SYSTEMS	64.08
Definition of	51.01
EXHIBITION BUILDINGS	54.001
EXISTING, Definition of	51.01
EXISTING BUILDINGS	
Additions, alterations, repairs	50.03, 50.07
Application of code	50.03
Barrier-free environment.....	52.04
General orders on (refer to chapters Ind 160-164)	
EXIT ACCESS.....	51.01, 51.167
EXIT COURT, Definition of	51.01
EXIT DISCHARGE GRADE, Definition of	51.01
EXIT DISTRIBUTION	51.151
EXIT LIGHTS*	51.15
EXIT LOCKS	51.15, 58.20, 58.58
EXIT TRIANGLE.....	54.02
EXIT, VERTICAL, Definition of	51.01
EXITS (see MEANS OF EGRESS)	
EXPLOSIVES, Storage of (refer to chapter Ind 5)	
EXPOSED EXTERIOR STRUCTURAL COLUMNS AND FRAMING	51.02, 51.03
EXTERIOR OPENINGS	
Doors (see DOORS AND DOOR ASSEMBLIES)	
Ducts	64.19
Exits	51.15, 51.20
Fire protection	51.047, 51.048, 51.049
Framing, wood	51.03
Horizontal exits	51.19
Intakes	64.19
Shutters	51.03
Vents	64.19, 64.39, 64.40
Windows	52.02
EXTERIOR OPENINGS, PROTECTION REQUIRED	
Because of location on property	51.03, 62.22
Because of type of construction.....	51.03
EXTERIOR STAIRWAYS	51.16, 51.20, 54.03
EXTERIOR WALL	
Construction	51.03
Definition of	51.01
F	
FACTORIES	54.001
FALLOUT SHELTER	50.07
FAMILY, Definition of	51.01
FARM BUILDINGS, exempt.....	50.04
FEE SCHEDULE (refer to chapter Ind 69)	

FENCES (refer to chapter Ind 35)	
FENESTRATION IN-FILL PANELS.....	51.02
FILLING STATIONS.....	59.01
FILM, MOTION PICTURE.....	55.39
FINES (refer to chapter 101, Stats.).....	50.26
FINISHES (see "Interior Finishes")	
FIRE	
Alarms	51.24, 54,17, 58.27, 58.63, 59.24
Dampers	51.049, 64.42
Detectors	51.01, 56.03, 57.16, 61.14
Doors.....	51.047
Escapes	51.20
Exits*	
Extinguishers, portable	51.22, 54.145, 55.34, 56.18, 57.18, 58.28 59.23, 61.20, 62.50
Protection of misc. heating devices*	
Protection requirements.....	51.02, 51.03
Ratings of material and assemblies	51.04
Sprinklers	51.23, 52.01, 52.015
Standpipes	51.21, 58.28, 58.62, 59.23, 62.30
Stopping	53.63
Walls	51.02
FIRE DISTRICTS, Establishment of	50.06
FIRE DOOR, Definition of	51.01
FIRE DOOR ASSEMBLY, Definition of	51.01
FIRE DOOR CLOSING DEVICE, Definition of	51.01
FIRE EXTINGUISHING SYSTEMS (see SPRINKLERS and STANDPIPES)	
FIRE PREVENTION, DETECTION AND SUPPRESSION....	52.01
FIRE RESISTANCE AND FIRE RESISTIVE	
MATERIAL, Definition of	51.01
FIRE RESISTANCE RATINGS	
Assemblies	51.045
Construction	51.03
Materials	51.045
Separation of classes of construction	51.02
Separation of occupancies*.....	51.08
Standards and references.....	51.04
FIRE RESISTIVE	
Classification, definition of	51.01
Protection, definition of	51.01
Protection, directly applied, definition of	51.01
Rating, definition of	51.01
Standards	51.04
FIRE RETARDANT	
Roof coverings, definition of.....	51.01
Treated wood, definition of	51.01
FIRE SUPPRESSION SYSTEM, Definition of.....	51.01
FIRE WINDOW ASSEMBLY, Definition of.....	51.01
FIRE ZONES, local requirement	50.06

Index

FIREPLACES AND FIREPLACE STOVES	58.24, 64.22
FIRESTOPPING	
Between wood sleepers	51.03
For wood frame construction	53.63
FIRST FLOOR, Definition of	51.01
FLAMEPROOFING REQUIRED	55.19, 62.45
FLAME-SPREAD CLASSIFICATION, Definition of	51.01
FLOODPLAIN, CONSTRUCTION ON	50.07
FLOOR	
Area, definition of	51.01
Anchorage (see ANCHORAGE, ANCHORS)	
Definition of	51.01
Drainage	52.60
Finish	52.57
Fire resistance	51.03
First, Determination of	51.02
Level, definition of	51.01
Loads	53.10, 53.11, 53.13
Mezzanine, definition of	51.01
Pits, in garage	59.11
Plenum systems	64.41
Plywood	53.61
Posting loads	54.17
Protection for stoves, water heaters	64.51
Trap door, stage	55.22
FLUES	64.46
FOAM PLASTICS	51.06
FOOTING (also see FOUNDATIONS)	53.20
FORMS, CONCRETE	53.40
FOUNDATIONS	
Basement wall loads	53.11
Caissons	53.24
Concrete, plain and reinforced	53.40
Design	53.11
Frost penetration	53.23
Masonry	53.322
Permit for	50.13, 50.14
Piers	53.322
Piles	53.24
Pole	53.28
Protection of adjoining property	53.26
Settlement	53.25
Soil bearing	53.21
Walls	51.02
Wood and timber, treated	51.02, 53.61, 53.64
FOYER, Definition of	51.01
FRAMING	
At chimneys	53.63, 64.46, 64.49
Floor	51.02, 51.03
Steel	53.50, 53.52

Vertical.....51.02, 51.03
 Wood53.61-53.63
FREESTANDING FREEZER AND COOLER.....51.01, 51.06
FREEZER WAREHOUSES.....54.01
FREEZING
 Concrete53.40
 Fixtures52.61
 Foundations.....53.23
 Masonry53.33
FRONT YARD, Definition of51.01
FROST, DEPTH OF FOUNDATION FOR.....53.23
FUEL CONTRIBUTED CLASSIFICATION (FCC),
 Definition of.....51.01
FUNERAL HOMES.....54.001 or 55.01
FURNACE
 Definition of.....51.01
 Duct, definition of.....51.01
 Requirements.....64.21, 64.22
FURRING.....51.03, 51.06
FUSIBLE LINKS REQUIRED
 For fire doors54.02
 For horizontal exits.....51.19
 For motion picture machine booths.....55.43, 55.44
 For stage smoke outlets55.24

G

GALLERY—GALLERIES.....56.001
GALVANIZED
 Ducts.....64.34
 Roofing51.05
 Siding51.03
GARAGES.....59.10
 Repair.....59.10
 Storage59.10
GLASS
 Block assemblies51.048
 Labeling and identity51.048
 Maximum areas51.03, 51.048
 Wired.....51.048
GLAZING, SAFETY51.14
GRADE
 At building, definition of51.01
 Exit discharge grade, definition of51.01
 Marked lumber53.61
 Marked plywood.....53.61
GRAIN ELEVATORS, combined with place of employment54.001
GRANDSTANDS62.70-62.81
GRAVITY EXHAUST VENTILATION, Definition of51.01
GRAVITY SIPHON-TYPE VENTILATOR.....64.08

Index

GREENHOUSE	
Production Type.....	62.90
Teaching/Mercantile Type.....	62.90
GROSS AREA, Definition of.....	51.01
GROUND FLOOR, Definition of.....	51.01
GROUP OCCUPANCY	
Assembly	54.001 or 55.01
Business.....	54.001
Child day care.....	60.001
Community-based residential facilities.....	61.001
Hazardous	59.001
Health care	58.001
Industrial.....	54.001
Mercantile	54.001
Places of detention.....	58.40
Residential.....	57.001
Schools.....	56.001
Specialty	62.001
Storage	54.001
Theaters	55.001
GROUT MASONRY	53.313, 53.321
GUARD TOWERS.....	58.67
GUARDRAILS.....	51.162
Grandstands	62.77
Parking structures	62.28
GYMNASIUMS	56.001
GYPSUM	
Concrete	53.41
Fire resistance ratings	51.045
Reinforced	53.41
Wallboard	51.045

H

HABITABLE ROOM	
Definition of.....	51.01, 61.01
Floors below grade.....	57.11
HALLS	
Assembly	54.001 or 55.01
Dance	54.001 or 55.01
Recreation	54.001 or 55.01
HANDRAILS.....	51.161
Fire escapes.....	51.20
Ramps*.....	52.04
Stairways.....	51.161
HANGARS, AIRPLANE	59.10, 59.23
HAZARDOUS OCCUPANCIES (Ch. ILHR 59).....	59.10
Construction.....	59.11
Exiting.....	59.13-59.19
Fire detection and suppression	59.23-59.24
Height and area	59.12
Isolation of hazards.....	59.21

Occupancy separations.....59.22
 Sanitary facilities.....59.20
 HAZARDOUS PIPING, Definition of51.01
 HAZARDS, ISOLATION OF*
 HEADROOM 51.164, 62.25
 HEALTH CARE FACILITIES (Ch. ILHR 58)..... 58.001
 Automatic sprinklers.....58.29
 Class of construction.....58.01
 Corridor wall construction58.31
 Detention, alarm and communication systems58.27
 Elevator lobby enclosures58.22
 General requirements58.01
 Separation from other occupancies.....58.02
 Smoke barriers.....58.30
 HEATED SIDEWALK, PROHIBITED63.11
 HEATING SYSTEM, Definition of51.01
 HEATING, VENTILATING AND AIR
 CONDITIONING (Chapter ILHR 64)
 Air cleansing devices.....64.16
 Air movement and distribution64.06
 Air velocities.....64.31
 Approval of drawings and specifications.....50.07, 50.12, 64.02
 Automatic controls64.17
 Chimneys, Factory built64.48
 Chimneys, Masonry64.46
 Combustion air intakes64.09
 Contamination of air.....64.18
 Dampers and damper controls64.09, 64.42
 Design50.07
 Duct connectors.....64.35
 Duct construction64.34
 Duct design64.31
 Duct use64.32
 Equipment installations.....64.21
 Equipment ratings and safety controls.....64.20
 Exhaust ventilation system.....64.08
 Fans and blowers64.44
 Fire dampers and fire doors64.42
 Gas vents.....64.50
 Gravity ventilation ducts.....64.38
 Heat loss and capacity64.03
 Inside design temperatures and ventilation64.05
 Insulation64.37
 Location of outside air intakes or exhausts.....64.19
 Mechanical ventilation systems64.06
 Natural ventilation systems.....64.07
 Occupancy requirements64.54-64.68
 Outside temperature design conditions.....64.04
 Piping64.23
 Plenums.....64.41
 Relief vents.....64.40
 Smoke pipes.....64.49
 Smokestacks, metal.....64.47
 Solid fuel burning.....64.21

Index

Special equipment requirements.....	64.22
Tempered air requirements	64.13
Tempered outside air requirements	64.14
Underground duct construction and installation	64.33
Ventilation discharge	64.39
Vertical shafts.....	64.36
HEAVY TIMBER CONSTRUCTION	51.03
HEIGHT AND AREAS*	
Affect stairways	51.15
Affect windloads.....	53.12
Automatic sprinklers.....	52.01, 52.015
Chimneys.....	64.45
Classification of construction	51.03
Masonry walls (also see MASONRY CONSTRUCTION).....	53.322
Parapet walls	51.02, 53.322
Raising adjoining chimneys and vents.....	64.45
Restrictions	51.03
Towers, spires, poles	53.61, 62.35
Types of construction	51.03
HEIGHT OF BUILDINGS*	
Automatic sprinklers.....	51.01, 52.015
Classes of construction.....	51.03
Definition of.....	51.01
Measurement of	51.01
HOLLOW BONDED WALL, Definition of	51.01
HOLLOW MASONRY	
Units.....	53.311
Walls	53.321, 53.322, 53.34
HOODS, KITCHEN EXHAUST	64.67
HORIZONTAL EXITS	51.19
HORSE ARENA	54.001 or 55.01
HOSE	
Sprinklers	51.23
Standpipes	51.21
HOSPITALS.....	58.001
Definition of.....	51.01
HOTELS.....	57.001
I	
ICE PLANTS	54.001
ILLUMINATION OF EXITS*	
IN-FILL PANELS, FENESTRATION	51.02
INCREASE IN AREAS ALLOWED	52.015, 54.01, 57.01, 59.12
INFILTRATION, CONTROL OF	63.11, 64.03
INNER LOT LINE COURT, Definition of	51.01
INSPECTIONS (also see ch. 101, Stats.).....	50.18
INSULATION	63.22
Ducts.....	63.22, 64.37
Linings, duct.....	64.36

Pipe coverings..... 63.22, 64.23
 Slab, perimeter..... 63.12
 INTAKE, OUTSIDE AIR, Definition of 51.01
 INTERIOR BALCONY (see MEZZANINE)
 Definition of..... 51.01
 INTERIOR FINISHES
 Application of 51.07
 Definition of..... 51.01
 General 51.03, 51.07, 58.26
 Flame spread 51.07, 58.26
 Floor finish, toilet rooms 52.57
 Smoke developed 51.07, 58.26
 Walls, toilet rooms..... 52.58
 INTERIOR PARTITIONS..... 51.02
 INTERIOR STAIRWAYS, ENCLOSED..... 51.18
 ISOLATION OF HAZARDS*

J

JAILS 58.40
 JOISTS
 Anchorage (see ANCHORAGE, ANCHORS)
 Bridging (see BRIDGING)
 Concrete 53.40
 Decay resistance 53.63
 Fastenings (see ANCHORAGE, ANCHORS)
 Fire cuts 53.63
 Fire resistance ratings 51.045
 Fire stopping 53.63
 Floor framing..... 53.63
 Steel..... 53.50, 53.52
 Wood 53.60-53.63

L

LABELS
 Exit door bolts..... 51.15
 Fire doors 51.047
 Roofing 51.05
 Safety glazing 51.14
 Windows..... 51.048
 LADDERS, ACCESS TO ATTIC OR ROOF..... 51.02
 LAMINATED MATERIALS 53.60
 LATERAL BRACING 53.50
 LAUNDRY ROOMS, Protection for 52.015, 57.14, 58.24, 60.37
 LAVATORIES* 52.60
 LIBRARIES..... 56.001
 LIGHT
 For exit signs 51.15
 For occupancy groups*
 Lighting power budgets 63.41
 LIGHT TRANSMITTING PLASTICS 51.065

Index

LIME, For masonry construction	53.314
LINTEL	51.03
LIQUEFIED NATURAL GAS (Refer to chapter ILHR 12)	
LIQUEFIED PETROLEUM GAS (refer to chapter ILHR 11)	
LIQUIDS, FLAMMABLE (refer to chapter ILHR 10)	
LIVING UNIT, Definition of	51.01
LOADS, DEAD	53.10
LOADS, DESIGN COMBINATIONS.....	53.15
LOADS, FOOTINGS AND FOUNDATIONS.....	53.20
LOADS, LIVE	
Concentrated	53.11
Cranes	53.13
Floor loads, occupancy.....	53.11
Footings.....	53.11
Impact.....	53.13
Items not covered	53.11
Occupancy loads	53.11
Posting loads	54.17
Reduction of loads	53.11
Roof.....	53.11
Sidewalks.....	53.11
Snow	53.11
Soil	53.21
Tests.....	53.21
Wind.....	53.12
LOADS, PILES	53.24
LOADS, RAILINGS.....	51.161, 62.28
LOADS, WIND	53.12
LOBBY	
Definition of.....	51.01
Enclosure of	58.22
In theater	55.15
LOCAL REGULATIONS.....	50.06
LOCKS ON DOORS, Prohibited	51.15
LOCKS ON DOORS, Permitted	51.15, 58.20
LODGING HOUSES.....	57.001
LOT LINE, Definition of	51.01
LOT LINES, Plot plan required	50.12
LUMBER.....	53.61

M

MAINTENANCE	51.21, 51.22, 51.23, 51.24, 51.245, 52.01, 52.015, 52.22, 52.64, 61.21, 64.52
MAJOR APPARATUS, Definition of.....	51.01
MANSARDS	51.03
MASONRY CONSTRUCTION	
Aggregate	51.045, 53.312
Basement walls	53.322

Block	53.311
Bond (see BOND, MASONRY)	
Brick.....	53.311
Cast stone.....	53.311
Cavity walls.....	53.321, 53.322
Cementitious materials	53.314
Ceramic	53.36
Ceramic veneer	53.36
Change in thickness	53.34
Chases	53.34
Chimney walls	53.321
Clay or shale units	53.311
Composite.....	53.322
Concrete units.....	53.311
Construction	53.33
Corbeling	53.34
Definition of.....	51.01
Design, empirical	53.322
Design, engineered	53.323
Details, construction.....	53.34
Erection, general.....	53.01
Fire resistance materials	51.043-51.045
Fire resistance ratings.....	51.043
Glass blocks	51.048
Grout.....	53.313
Gypsum, mortar	53.312
Gypsum units	53.311
Hollow units	53.311
Jointing	53.322, 53.36
Lateral support.....	53.322
Materials	53.31
Mortar.....	53.312
Piers	53.322
Protected.....	51.03
Protection against freezing.....	53.33
Reinforced, ties and anchors	53.316
Stone	53.311
Terra cotta	53.36
Tests.....	53.35
Types.....	53.321
Units.....	53.311
Unprotected.....	51.03
Veneered walls	53.36
Wall thickness.....	53.322
Water	53.315
Working stresses	53.311, 53.312
MATERIALS, METHODS AND DEVICES, Approval of	50.19
MEANS OF EGRESS*	
Aisles*	
Arrangement of exits*	
Balconies, exterior.....	51.02
Capacity of exits.....	51.15
Courts.....	52.05
Distribution.....	51.151
Doors, exit*	51.15

Index

Doors, revolving, sliding	51.15
Enclosure of exits*	51.02
Fire alarms	51.24
Fire escapes.....	51.20
Foyer	55.15
General provisions*	
Hardware.....	51.15
Horizontal exits	51.19
Illumination (refer to chapter Ind 19)	
Locking.....	51.15, 58.20, 58.58
Monumental stairs.....	54.08
Number of exits*	
Number of persons*	
Outlets, exits.....	52.21
Panic hardware	51.15
Ramps (see RAMPS)	
Rescue platforms	54.03, 57.05
Signs*	51.15
Sliding glazed patio type.....	57.06, 60.12
Stairway, construction	51.16
Units of width.....	51.15
MECHANICAL VENTILATION (see VENTILATION)	
MENTAL HOSPITALS.....	58.001
MERCANTILE, Occupancy.....	54.001
METAL	
Anchors (see ANCHORAGE - ANCHORS)	
Ducts (see DUCTS)	
Fire escapes.....	51.20
Roof covering.....	51.05
Smoke pipes	64.50
Smokestacks	64.47
Veneers.....	53.56
Window frames.....	51.048
METHODS OF CONSTRUCTION	50.19
MEZZANINE, MEZZANINE FLOOR.....	51.01, 51.02
MINI-WAREHOUSES.....	54.22
MINIMUM DESIGN LOADS.....	53.11
MOBILE TRAINING CLASSROOMS.....	56.40-56.46
MONITORS, ROOF.....	51.02, 51.14
MONUMENTAL STAIRS	54.08
MORTAR	53.312
MOTELS	57.001
MOTOR VEHICLE GARAGES	59.10
MOVING STAIRWAYS, ESCALATORS (refer to chapter ILHR 4)	
MULTIPLE DWELLING (APARTMENT HOUSE)	
Definition.....	51.01
Occupancy, residential	50.04
MUSEUMS	56.001

N

NAILS 53.63

“NATIONAL” PREFIX STANDARDS (see STANDARDS)

NET AREA, Definition of 51.01

NONBEARING PARTITIONS OR WALLS 51.02

 Definition of 51.01

 Fire protective requirements 51.03

 Fire resistance ratings 51.03

 Masonry 53,17, 53.322

NONCOMBUSTIBLE CONSTRUCTION, Definition of 51.01

NURSING HOMES 58.001

 Definition of 51.01

O

OBSTRUCTION - PROHIBITED*

 Aisles 52.21

 Exit outlet 51.15

 Horizontal exit 51.19

 Stairways 51.16

OCCUPANCY OR USE, Definition of 51.01

VARIANCE, PETITION FOR 50.25

OCCUPANCY CHAPTERS

 CHILD DAY CARE FACILITIES (including all public and private day care centers accommodating children, including all buildings, or parts of buildings, used as child day care facilities) Chapter ILHR 60

 COMMUNITY-BASED RESIDENTIAL FACILITIES (CBRF) (including facilities providing care, treatment and services to 9 through 20 unrelated adults located in existing buildings and sheltered facilities for battered women) Chapter ILHR 61

 FACTORIES, OFFICE AND MERCANTILE BUILDINGS (including all factories and workshops, office buildings, telegraph and telephone offices, mercantile establishments where commodities are bought or sold, taverns, warehouses, railroad stations, exhibition buildings, and places where not more than 100 persons assemble for recreation, entertainment, worship, or dining purposes) Chapter ILHR 54

 HAZARDOUS OCCUPANCIES (including all garages [except private garages], filling stations and related buildings and structures, automobile tire or battery shops, and other occupancies where flammable or combustible liquids or other hazardous materials are manufactured, processed, stored, or otherwise handled) Chapter ILHR 59

 HEALTH CARE FACILITIES AND PLACES OF DETENTION (including hospitals, nursing homes, jails, reformatories and lock-ups) Chapter ILHR 58

Index

RESIDENTIAL OCCUPANCIES (including all apartment buildings, garden apartments, row houses, town houses, condominiums, rooming houses, hotels, motels, dormitories, convents, monasteries, homes for the aged, community-based residential facilities, sheltered facilities for battered women, and other places of abode	Chapter ILHR 57
SCHOOLS AND OTHER PLACES OF INSTRUCTION (including all public and private schools, universities, colleges, academies, seminaries, libraries, museums and art galleries, including all buildings or parts of buildings used primarily for instructional purposes)	Chapter ILHR 56
SPECIALTY OCCUPANCIES (including open parking structures, radio and television transmitting and receiving antenna, tents, outdoor theaters, assembly seating facilities, greenhouses, pedestrian access structures connecting buildings)	Chapter ILHR 62
THEATERS AND ASSEMBLY HALLS (including all buildings, or parts of buildings, containing an assembly hall having a stage which may be equipped with curtains or permanent or movable scenery, or which is otherwise adaptable to the showing of plays, operas, motion pictures or similar forms of entertainment; and all buildings, or parts of buildings, other than theaters, which will accommodate more than 100 persons for entertainment, recreation, worship or dining purposes)	Chapter ILHR 55
OCCUPANCY SEPARATION	51.08
OCCUPANT LOAD	51.15
OCCUPIED, Definition of	51.01
OFFICIAL, BUILDING (see ADMINISTRATION AND ENFORCEMENT)	
OIL STORAGE	64.23
OPENINGS	
Combustion air	64.09
Elevator enclosures*	51.02, 51.03
Exterior walls	51.03
Exterior walls for fire department	52.02
Fire department access	52.02
Horizontal protection	51.03
Motion picture projection booths	55.39
Protected with fire doors or windows	51.047, 51.048
Rated construction	51.045
Stairways or shaftways	51.02, 51.03
OPEN PARKING STRUCTURES	62.20
OPEN SPACES, Definition of	51.01
OPEN WEB STEEL JOIST	53.52
ORIEL WINDOWS (Bay)	51.03
ORPHANAGES	57.001
OUTDOOR OPENINGS, Definition of	51.01
OUTDOOR THEATERS	62.52-62.62
OUTLET (SUPPLY OPENING), Definition of	51.01

OUT-PATIENT SURGICAL FACILITIES

Definition of..... 51.01
 General 64.57
OUTSIDE AIR, OUTSIDE AIR INTAKE, Definition of 51.01
OUTSIDE STAIRS 51.16, 51.20
OWNER
 Application for permit 50.12
 Definition (Refer to ch. 101, Stats.)
 Maintenance of buildings 52.22, 52.64
 Responsibility 50.11

P

PANEL WALL, Definition of 51.01
PANIC HARDWARE 51.15
PARAPET WALL 51.02, 53.34
PARKING GARAGE, OPEN DECK 62.20
PARKING SPACES, Reserved for physically disabled 52.04
PARTITION 51.02
 Definition of 51.01
PARTY WALL, Definition of 51.01
PASSAGEWAYS* 52.21
PEDESTRIAN ACCESS STRUCTURE CONNECTING BUILDING 62.97
PENALTIES AND VIOLATIONS 50.26
PENTHOUSE 51.02, 51.03
 Definition of 51.01
PERMITS, BUILDING 50.06
 To start construction 50.14
PETROLEUM STORAGE (refer to chapter ILHR 10)
PEWS, Width 55.13
PHYSICALLY DISABLED, General requirements 52.04
PIERS
 Definition of 51.01
 Masonry 53.322
PILASTERS, Masonry 53.322
PILES 53.24
PIPE
 Duct 64.33
 Smoke 64.49
 Steam or hot water 64.23
PIPING, HAZARDOUS, Definition of 51.01
PLACE OF ABODE, Definition of 51.01
PLACE OF EMPLOYMENT, Definition of 51.01
PLACES OF DETENTION 58.40
 Class of construction 58.42
 Exiting 58.47-58.58
 Fire detection and suppression 58.62-58.65

Index

Guard towers and observation stations	58.67
Isolation of hazards.....	58.61
Protection of openings	58.59-58.60
Sanitary facilities.....	58.66
Separation from other occupancies.....	58.43
PLANS	
Examination and approval.....	50.12
Fee (also refer to chapter Ind 69).....	50.20
Plot.....	50.12
Prepared outside Wisconsin	50.08
Required for permit to start.....	50.14
Types of.....	50.12
PLANT, MANUFACTURING, Occupancy	54.001
PLASTICS, FOAM.....	51.06
PLASTICS, LIGHT TRANSMITTING	51.065
PLASTIC PLUMBING AND ELECTRICAL COMPONENTS	51.049
PLATFORMS.....	51.16
Rescue platforms	54.03, 57.05
PLENUM	64.41
PLOT DIAGRAM OR PLAN, Required	50.12
PLYWOOD	53.61
POLE BUILDING	51.08
POLE FOUNDATIONS	53.28
POLICE STATION, Occupancy	54.001, 57.001
PORCH, Definition of.....	51.01
PORTLAND CEMENT, Masonry mortar	53.35
POSTING	
Floor loads.....	54.17
Occupancy permit for changed loading.....	54.18, 55.06
Permits.....	50.06
POWER AND DUTY OF BUILDING OFFICIAL.....	50.06, 50.12
POWER PLANT, Occupancy	54.001
PRESSURE TANKS	51.21, 51.23
PRESSURE TREATED WOOD	
Fire retardant, definition of.....	51.01
For decay prevention	53.63
PRESTRESSED CONCRETE	53.40
PRISON, Occupancy	58.40-58.69
PRIVATE, Exempt from code.....	50.04, 57.001, 59.01
PRIVATE GARAGES	59.01
PROCEDURE, Appeals	50.24
PROJECTION BOOTH	55.39
PROJECTION FROM BUILDINGS.....	51.03
PROPERTY, ADJOINING, Protection of	53.26
PROPERTY LINE, Definition of.....	51.01

PROSCENIUM, STAGE AND APPURTENANT ROOMS (see chapter ILHR 55)	
PROTECTION AGAINST DECAY AND TERMITES.....	53.63
PROTECTION OF DOOR OPENINGS IN WALLS AND PARTITIONS	51.047
PROTECTION OF VERTICAL OPENINGS, STAIRS AND ELEVATORS*	51.02, 51.03
PROTECTION OF WALL OPENINGS	51.047, 51.048, 51.049
PUBLIC BUILDING, Definition of	51.01
PUBLIC SEWERS, Connection with	52.62
PUBLIC THOROUGHFARE, Definition of.....	51.01
PUMPS, FIRE	51.21, 51.23
R	
RADIATION AND CONVECTION EQUIPMENT	64.21
RADIO RECEIVING ANTENNA	62.35
RAIL AROUND OPENINGS.....	51.16, 54.10, 62.28
RAILING (see HANDRAILS)	
RAMPS	
Apartment buildings, hotels and places of detention	57.05
Barrier-free environments	52.04
Factories, office and mercantile buildings	54.03
General requirements.....	51.16
Open parking structures.....	62.26
Schools and other places of instruction.....	56.06
Theaters and assembly halls.....	55.08
RANGE HOODS, Ventilating	64.67
RANGES, Clearances	64.51
RECEIVING ANTENNAE, Television and radio	62.35
RECORD CARD	
Automatic fire sprinkler tests	51.23, 52.01, 52.015
Fire alarm tests.....	51.24
Fire prevention inspections	60.19
RECREATION HALLS	54.001 or 55.01
REDUCTIONS, Live loads	53.11
REFINERIES, Flammable liquids (see chapter ILHR 10)	54.001
REFORMATORIES.....	58.40-58.69
REFRIGERATION (see chapter ILHR 45)	64.10
REINFORCED CONCRETE.....	53.40
REINFORCED GYPSUM CONCRETE.....	53.41
REINFORCED MASONRY.....	53.323
REINFORCEMENT (see REINFORCED CONCRETE and MASONRY)	
RELOCATABLE CLASSROOMS	56.30
REMODELING AND ALTERATIONS.....	50.03, 50.07, 50.12, 52.04
Definition of.....	51.01

Index

REPAIR	52.21, 52.22, 52.64, 55.50, 60.19
Repair garage.....	59.10
REQUIRED, Definition of.....	51.01
REQUIRED EXIT CORRIDOR, Definition of	51.01
RESCUE PLATFORMS.....	54.03, 57.05
RESIDENCES, One- and two-family exempt	50.04
(Also refer to Uniform Dwelling Code)	
RESIDENTIAL OCCUPANCIES (Ch. ILHR 57)	57.001
Allowable height and area	57.02
Construction.....	57.01
Fire detection and suppression	57.15-57.18
Habitable rooms below grade.....	57.11
Isolation of hazards.....	57.14
Number, location, capacity and type of exit.....	57.03-57.10
Rowhouse	57.19
Sanitary facilities.....	57.12
Windows.....	57.13
REST ROOMS*.....	52.50, 54.12
RESTAURANTS.....	54.001, 55.01
RESTRAINED SUPPORT, Definition of	51.01
RETAINING WALL.....	53.27, 53.34
Definition of.....	51.01
RETROACTIVITY.....	50.02, 56.03, 57.16, 61.14, 61.26, 63.001
RETURN (or EXHAUST OPENING), Definition of.....	51.01
REVOLVING DOORS, at nonrequired exit.....	51.15
RISERS, for stairways.....	51.16
ROADWAY, Definition of	51.01, 57.02
ROOF, ROOF CONSTRUCTION	
Access to attic or roof	51.02, 51.20, 57.19
Anchorage (see also ANCHORAGE, ANCHORS).....	53.12
Coverings.....	51.02, 51.05
Definition of.....	51.01
Drainage.....	53.11
Fire-resistance ratings.....	51.043
Fire-resistive construction.....	51.03
Heavy timber.....	51.03
Joists (see JOISTS)	
Live loads	53.11
Mansard roofs.....	51.03
Materials, roofing.....	51.02, 51.05
Nailing schedule.....	53.63
Over stages	55.24
Parapets	51.02, 53.34
Protection of adjoining buildings	51.03, 53.26
Scuttles.....	51.02
Sheathing.....	53.61
Skylights.....	51.065
Towers.....	62.36
Wind loads.....	53.12
Wood frame construction	53.60-53.63

ROOF COVERING, Definition of	51.01
ROOF COVERINGS	51.02, 51.05
ROOF LOADS.....	53.11
ROOF SHEATHING.....	53.61
ROOFING (see ROOF, ROOF CONSTRUCTION and ROOF COVERINGS)	
ROOM, Definition of.....	51.01
ROOM, SPACE HEATERS	64.22
ROOMING HOUSE.....	57.001
ROW HOUSE.....	51.01, 57.19
RUBBLE MASONRY	53.322

S

SAFE PLACE

Defined (refer to ch. 101, Stats.)

Exit to 52.21

SAND

Bearing soil capacity..... 53.21

Concrete
 53.40 |
Mortar
 53.12 |
SANITARIUM, Occupancy
 58.001 |

SANITATION FACILITIES..... 52.50-52.64

SCHOOLS..... 56.001

SCOPE OF CODE (see also chapters ILHR 51-64)
 50.02 |
SCUTTLE
 51.02, 57.19 |

SEATS, SEATING

Definition of..... 62.10

Grandstands, bleachers, places of assembly..... 62.76

Physically disabled
 52.04 |
Schools, auditoriums, gymnasiums, field houses
 56.13, 56.14 |
Theaters, assembly halls
 55.13 |

SELF-CLOSING DOORS

Normally closed (furnace rooms, shaft enclosures, etc.)*

Normally open (sliding, horizontal exit)..... 54.01

SEMINARIES
 56.001 |

SEPARATION, CLASS OF CONSTRUCTION..... 51.02

SEPARATION, OCCUPANCY
 51.08 |

SEPTIC TOILETS..... 52.62

SERVICE STATIONS, AUTO
 59.10 |
SETBACK, Definition of
 51.01 |

SHAFT

Definition of..... 51.01

Rated..... 51.02, 51.03

SHALL, Definition of
 51.01 |

SHORING, Adjoining foundations..... 53.26

SHUTTERS, FIRE
 51.03, 64.42 |

Index

SIAMESE CONNECTIONS	51.21, 51.23
SIDEWALKS, HEATED	63.11
SIGNS	
Barrier-free	52.04
Capacity of occupancy	54.18, 55.06
Clearance limitation.....	62.25
Definition of.....	51.01
Exit signs*	51.15
Identification signs.....	52.04
Illumination of exits*.....	51.15
Posting floor loads.....	54.17
Toilet rooms	52.52
SIMPLE SUPPORT, Definition of	51.01
SINKS (see LAVATORIES)	
SKATING RINKS (Indoor)	54.001 or 55.01
SKYLIGHTS, DOMES	51.065
SKYWALKS.....	62.97
SLAB	
Minimum thickness, for fire-resistive purposes	51.043
Minimum thickness, for floors	51.043
Minimum thickness, for roofs.....	51.043
Reinforced concrete.....	53.40
SLATE, ROOFING	51.05
SLEEPERS	51.03
SLEEPING AREA.....	51.01, 57.16, 61.14
SMOKE BARRIER	58.27, 58.64
SMOKE CONTROL SYSTEM - ATRIUMS	52.07
SMOKE DETECTION	51.245, 56.03, 57.16, 61.14, 64.42
SMOKE PIPES, SMOKESTACKS AND BREECHING ..	64.45-64.50
SMOKEPROOF STAIR ENCLOSURE	51.18
SMOKE VENTS, STAGE	55.24
SOIL	53.20
SOLID FUEL EQUIPMENT.....	58.24, 64.21, 64.22
SPACE HEATERS	64.22
Definition of.....	51.01
SPANDREL, Definition of.....	51.01
SPECIAL OCCUPANCIES	
Airplane hangars.....	59.10
Amusement park buildings.....	54.001
Assembly occupancies	55.01
Auto service stations.....	59.01
Bowling alleys.....	54.001 or 55.01
Churches.....	54.001 or 55.01
Day care centers	60.001
Dry cleaning establishments	54.001
Farm buildings.....	50.04
Garages (public and private).....	59.01
Grandstands	62.70

Greenhouses.....	62.90
Hazardous	59.01
Health care	58.01
Places of detention.....	58.40
Stadiums.....	62.70
Temporary structures	50.04
SPECIALTY OCCUPANCIES (chapter ILHR 62)	
Assembly seating facilities	62.70
Greenhouses.....	62.90
Open parking structures.....	62.20
Outdoor theaters.....	62.52
Pedestrian access structures connecting buildings	62.97
Skywalks	62.97
Television and radio transmitting and receiving antenna	62.35
Tents	62.42
SPECIFICATIONS ADOPTED (see STANDARDS)	
SPECIFICATIONS, Required for plan approval	50.12
SPIRAL STAIRS.....	51.16
SPLICES	53.50, 53.51
SPRAY PAINTING (refer to chapter Ind 1910, Safety & Health Code)	
SPRINKLERS	
Area increase permitted	54.01, 57.01, 59.12
Assembly occupancy	52.015
Automatic sprinklers.....	51.23, 52.01, 52.015
Basement.....	51.23, 52.015, 52.02
Distance of travel increase*	
Fire department connection	51.23
High-rise buildings.....	52.01
Hose threads.....	51.23
Low-rise buildings.....	52.015
Maintenance.....	51.23
Materials	51.23
Requirements.....	51.23, 52.01, 52.105
School occupancy.....	52.015, 56.03
Standards	51.23
Supervisory facilities.....	51.23
Tests, water supply.....	51.23
STABILITY	53.16
STADIUMS.....	62.70
STAGE (see chapter ILHR 55)	
STAIRS AND STAIRWAYS	
Basement.....	51.166
Chair lift.....	51.16
Curved.....	51.16
Design features	51.16
Enclosure of shaft	51.02, 51.03
Exterior	51.16, 54.03, 54.08
Fire escape.....	51.20
Interior enclosed stairs.....	51.18
Identification	51.165
Occupancy requirements*	

Index

Spiral	54.03, 57.05
Smokeproof tower*	51.17
STANDARDS AND SPECIFICATIONS ADOPTED	
Aluminum Association	51.27
American Concrete Institute (ACI)	51.26
American Institute of Steel Construction (AISC)	51.27
American Institute of Timber Construction (AITC)	51.27
American Iron and Steel Institute (AISI)	51.27
American National Standards Institute (ANSI)	51.27
American Plywood Association (APA)	51.27
American Society for Testing and Materials (ASTM)	51.25
American Society for Heating, Refrigerating and Air Conditioning Engineers (ASHRAE)	51.27
American Welding Society (AWS)	51.27
American Wood Preservers Bureau (AWPB)	51.27
Department of Health, Education and Welfare (DHEW)	51.27
National Fire Protection Association (NFPA)	51.27
National Forest Products Association	51.27
Steel Joist Institute (SJI)	51.27
Truss Plate Institute (TPI)	51.27
Underwriters' Laboratories (UL)	51.27
STANDPIPES	51.21
STEAM PIPES AND HOT WATER PIPES	64.23
STEEL CONSTRUCTION	
Aluminum	53.54
Caissons	53.24
Certification and identification	53.50
Fabrication	53.50
Fire resistance ratings	51.043
Fire resistive construction, type 1 and type 2	51.03
Joists, open web construction	53.52
Marking	53.50
Metal frame protected construction, type 3	51.03
Metal frame unprotected construction, type 6	51.03
Piles, steel	53.24
Reinforcing	53.316
Stainless steel	53.55
Structural steel	53.50
Veneered walls	53.36
Welding	53.53
STEEL PILES	53.24
STEPS	54.03, 55.09
STONE MASONRY	53.311, 53.322
STOP WORK ORDERS (refer to chapter 101, Wis. Stats.)	
STORAGE OF FLAMMABLES (also refer to chapter Ind 8)	60.19
STORAGE GARAGE	59.10
STORIES	
Definition of	51.01
Determination of number of	51.02
STORY, Definition of	51.01
STOVES (see RANGES)	

STREET

Definition of.....	51.01
Location of	54.01, 57.02, 59.12

STRUCTURAL REQUIREMENTS (Chapter ILHR 53)

Concrete	53.40
Foundations.....	53.20
Loads, minimum allowable	53.10
Masonry	53.30
Metals	53.50
Wood and wood fiber products.....	53.60

STRUCTURE, Definition of.....	51.01
-------------------------------	-------

STUDS	53.63
-------------	-------

SUPERVISION (of construction)	50.10
-------------------------------------	-------

SUPPORT (RESTRAINED and SIMPLE), Definitions of	51.01
---	-------

T

TEMPERATURE DESIGN	64.04, 64.05
--------------------------	--------------

TEMPERED AIR, Definition of	51.01
-----------------------------------	-------

TEMPERED OUTSIDE AIR, Definition of	51.01
---	-------

TEMPORARY BUILDINGS OR STRUCTURES	50.04
---	-------

TENTS.....	62.42-62.51
------------	-------------

TERRACE, Definition of.....	51.01
-----------------------------	-------

TESTING LABORATORIES, Approved	51.044
--------------------------------------	--------

TESTS

Diversified	51.06
Fire alarm	51.24
Fire doors	51.047
Fire resistance ratings of assemblies	51.043
Heating equipment	64.20
Load	53.23
Noncombustible material.....	51.01
Rating methods	51.043
Soil bearing.....	53.21
Sprinkler	51.23
Standpipes	51.21

THEATERS AND ASSEMBLY HALLS (Chapter ILHR 55)

THERMAL BARRIER.....	51.06
----------------------	-------

TILE (Veneers).....	53.36
---------------------	-------

TIMBER

Glued-laminated structural	53.61
Heavy construction.....	51.03

TIRE SHOPS	59.10
------------------	-------

TITLE AND SCOPE*

TOE BOARDS	54.105
------------------	--------

TOILET COMPARTMENTS

Floors	52.57
Walls and ceilings	52.58
Width of compartment	52.04, 52.59

Index

TOILETS	
Chemical.....	52.62
Compartments.....	52.04, 52.59
Fixtures.....	52.04, 52.60
Outdoor.....	52.63
Rooms*.....	52.50, 52.56
TOWERS.....	62.35
TREADS, STAIRS.....	51.16
TREATED WOOD (Fire Retardant), Definition of.....	51.01
TRIANGLE, EXIT.....	54.02
TRIM, WOOD.....	51.02, 51.03
TRUSSES.....	53.62
TYPES OF CONSTRUCTION, Features summarized.....	51.03
U	
UNDERPINNING.....	53.26
UNENCLOSED	
Ramps.....	52.04
Stairs.....	51.16
UNIFORM TREADS AND RISERS.....	51.16
UNIT HEATERS.....	64.21
Definition of.....	51.01
UNLIMITED AREA.....	54.01
URINALS*.....	52.60
USE, Definition of.....	51.01
V	
VARIANCE, Petition for.....	50.25
VENEERED WALL	
Anchorage masonry units.....	53.36
Definition of.....	51.01
On wood frame.....	53.36
VENTILATION	
Air-cleansing devices.....	64.16
Air for combustion.....	64.09
Air movement and distribution.....	64.15
Automatic controls.....	64.17
Contamination of air.....	64.18
Definitions.....	51.01, 64.12
Exhaust ventilation systems.....	64.08
Gravity exhaust ventilation, definition of.....	51.01
Location of intakes.....	64.19
Mechanical ventilation, definition of.....	51.01
Mechanical ventilation systems.....	64.06
Natural ventilation systems.....	64.07
Occupancy requirements.....	64.05
Tempered air.....	64.13
Tempered outside air.....	64.14
VENTILATOR, GRAVITY SIPHON TYPE.....	64.08
VENTS.....	64.45-64.50

VENT SHAFTS*	51.02, 51.03
VERTICAL EXIT, Definition of	51.01
VERTICAL FRAMING, WOOD	53.63
VERTICAL OPENINGS, ENCLOSURES*	51.02, 51.03
VESTIBULE OPENINGS	64.07
VIOLATION AND PENALTIES	50.26
VOLUME (TOTAL), Definition of	51.01

W

WALLS AND PARTITIONS	51.02
Anchorage (see ANCHORAGES-ANCHORS)	
Assemblies, fire resistance ratings and standards	51.043
Definitions	51.01
Elevator enclosures	51.02, 51.03
Exterior	51.03
Fire division	51.02
Fire protective requirements	51.03
Fire resistance rating for assemblies	51.045
Foundation	53.322
Furnace and boiler rooms*	
Glass block	51.048
Masonry (see MASONRY CONSTRUCTION)	
Materials, fire resistance ratings and standards	51.043
Noncombustible	51.01
Openings, fire protections	51.047, 51.048, 51.049
Parapets	51.02
Party wall, definition of	51.01
Stairways and exit enclosures	51.03
Wood stud	53.63
WAREHOUSES	54.001
Definitions of	51.01
Freezer warehouses	54.23
Mini-warehouses	54.22
WASTE OIL BURNING EQUIPMENT	64.21
WATER CLOSETS	52.04, 52.60
WELDER, Certification of	53.53
WELDING	53.53
WIDTH, Aggregate exit	51.15
WIND LOADS DESIGN	53.12
WINDOWS	52.02
Area limitation at rated wall	51.03
Fire	51.048
Required for natural light*	
Required for ventilation	64.07
Safety devices for cleaning	52.03
WINDOWLESS FLOOR LEVELS	52.015, 52.02
WIRED GLASS	
Fire-resistive doors and windows	51.047, 51.048
WIRING, ELECTRICAL (see also Wis.	
State Electrical Code)	52.20, 61.25

Index

WOOD AND WOOD FIBER CONSTRUCTION	53.60-53.63
WOOD BURNING STOVES	58.24, 64.21, 64.22
WOOD FOUNDATIONS	51.02, 53.61, 53.64
WOOD FRAME CONSTRUCTION.....	51.03

Y

YARD	
Definition of.....	51.01