

Table of Contents

DEPARTMENT OF COMMERCE

Building and Heating; Ventilating and Air Conditioning

Chapter

Comm 50	Administration and enforcement (p. 1)
Comm 51	Definitions and standards (p. 11)
Comm 52	General requirements (p. 59)
Comm 53	Structural requirements (p. 69)
Comm 54	Factories, office and mercantile buildings (p. 91)
Comm 55	Theaters and assembly halls (p. 99)
Comm 56	Schools and other places of instruction (p. 107)
Comm 57	Residential occupancies (p. 117)
Comm 58	Health care, detention and correctional facilities (p. 137)
Comm 59	Hazardous occupancies (p. 151)
Comm 60	Child day care facilities (p. 157)
Comm 61	Community-based residential facilities (CBRF) and sheltered facilities for battered women (p. 161)
Comm 62	Specialty occupancies (p. 167)
Comm 63	Energy conservation (p. 177)
Comm 64	Heating, ventilating and air conditioning (p. 213)
	Comm 50-64 Appendix A (p. 239)
	Comm 50-64 Appendix B (p. 311)
	Comm 50-64 Appendix C (p. 319)
	Index

Chapter Comm 50

ADMINISTRATION AND ENFORCEMENT

Subchapter I — Purpose and Scope

- Comm 50.01 Purpose of code.
Comm 50.02 Scope.

Subchapter II — Application of Building Code

- Comm 50.03 Application.
Comm 50.04 Buildings exempt from code requirements.
Comm 50.05 Existing buildings code.
Comm 50.055 Historic buildings code.
Comm 50.06 Local regulations.

Subchapter III — Design and Supervision

- Comm 50.07 Design.
Comm 50.08 Plans, specifications and calculations prepared outside Wisconsin.
Comm 50.10 Supervision.
Comm 50.11 Owner's responsibility.
Comm 50.115 Notice of intent.

Subchapter IV — Department Approval

- Comm 50.12 Plan examination and approval.
Comm 50.13 Footing and foundation approval.

- Comm 50.14 Permission to start construction.
Comm 50.15 Evidence of plan approval.
Comm 50.155 Sprinkler documents.
Comm 50.16 Revocation of approval.
Comm 50.17 Expiration of plan approval and extension of plan approval.
Comm 50.175 Department limitation.
Comm 50.18 Inspections.
Comm 50.19 Building product approvals.
Comm 50.20 Fees.

Subchapter V — First Class City and Certified Municipal Approvals

- Comm 50.21 Certified municipalities and counties.
Comm 50.22 Appointed agents.

Subchapter VI — Enforcement, Petition for Variance, Appeals, and Penalties

- Comm 50.23 Enforcement.
Comm 50.24 Appeals.
Comm 50.25 Petition for variance.
Comm 50.26 Penalties.
Comm 50.27 Appeals.

Note: Chapter Ind 50 as it existed on December 31, 1976, was repealed and a new chapter Ind 50 was created effective January 1, 1977; chapter Ind 50 was renumbered to be chapter ILHR 50, effective January 1, 1984. Chapter ILHR 50 was renumbered chapter Comm 50 under s. 13.93 (2m) (b) 1., Stats. and corrections made under s. 13.93 (2m) (b) 7., Stats., Register, April, 1998, No. 508.

Subchapter I — Purpose and Scope

Comm 50.01 Purpose of code. The purpose of this code is to protect the health, safety and welfare of the public and employees by establishing minimum standards for the design, construction, structural strength, quality of materials, adequate egress facilities, sanitary facilities, natural lighting, heating and ventilating, energy conservation, and fire safety for all public buildings and places of employment.

Note: The purpose as stated can be traced to the terms used in the "safe place" statutes, ch. 101, Stats.

Note: This code is intended for the protection of the public and is not intended as a design manual, a textbook or a construction manual.

Note: The code cannot address every conceivable design option; points of code application and clarification will be addressed and issued from time to time and will be published in the Wisconsin Building Codes Report available from the Safety and Buildings Division, P. O. Box 7969, Madison, Wisconsin 53707.

History: Cr. Register, December, 1976, No. 252, eff. 1-1-77.

Comm 50.02 Scope. The provisions of chs. Comm 50-64 apply to all public buildings and places of employment, except those indicated in s. Comm 50.04. The provisions of these chapters are not retroactive unless specifically stated in the administrative rule. Where different sections of these chapters specify different requirements, the most restrictive requirement shall govern, except as specified in ss. Comm 51.02 (1) (b) 4., 52.012, 52.013, 58.001 (2) (c) and 62.93. No part of this code is intended to prohibit or discourage the design and construction of innovative buildings or the use of new materials or systems provided written approval from the department is obtained. Under this section, written approval from the department shall include, but is not limited to, an acceptance through preliminary design consultation, plan review, petition for variance, official code interpretation, material approval or other written forms of communication.

Note: For a definition of "public building" and "place of employment," see ss. Comm 51.01 (102b) and 51.01 (104a) or s. 101.01 (2), Stats.

Note: Other state agencies and local municipalities may have adopted building or construction requirements that are either more restrictive or address other issues than those specified in this code.

Note: The overall enforcement responsibility for this code is equally shared by the building inspector and the fire inspector. Normally, the building inspector has primary responsibility during construction of the building, while the fire inspector has primary responsibility after the building is completed. The enforcement of many of the provisions of the code is the primary responsibility of the fire inspector, and com-

pliance with these provisions should be of primary concern while conducting the fire prevention inspections mandated by s. 101.14, Stats. See Appendix B for a listing of the code sections for which the fire inspector has the primary enforcement responsibility.

History: Cr. Register, December, 1976, No. 252, eff. 1-1-77; am. Register, December, 1981, No. 312, eff. 1-1-82; am. Register, October, 1982, No. 322, eff. 11-1-82; am. Register, December, 1983, No. 336, eff. 1-1-84; am. Register, August, 1985, No. 356, eff. 1-1-86; emerg. am. eff. 9-6-86; am. Register, November, 1986, No. 371, eff. 12-1-86; am. Register, March, 1991, No. 423, eff. 4-1-91; am., Register, March, 1995, No. 471, eff. 4-1-95; correction made under s. 13.93 (2m) (b) 7., Stats., Register, March, 2000, No. 531.

Subchapter II — Application of Building Code

Comm 50.03 Application. (1) **NEW BUILDINGS AND ADDITIONS.** The provisions of this code shall apply to all new buildings and structures, and also to additions to existing buildings and structures, except those indicated in s. Comm 50.04.

(2) **ALTERATIONS TO BUILDINGS.** The provisions of this code shall apply to all remodeling or alterations in any building or structure which affect the structural strength, fire hazard, exits, required natural lighting or replacement of major equipment. The provisions of this code shall apply to remodeling and alterations that effect energy efficiency as specified in s. Comm 63.001. These provisions do not apply to minor repairs necessary for the maintenance of any building or structure nor to buildings exempt, as listed in s. Comm 50.04.

(3) **CHANGE OF USE.** (a) If the use of an existing building or structure is changed in accordance with the definition of s. Comm 51.01 (87), and the requirements for the new use are more stringent than those for the previous use, the building or structure shall be made to comply with the requirements for the new use as provided in this code.

1. Exception. Unless the requirements for the new use are modified subject to the written approval by the department.

2. Exception. An existing building undergoing a change of use shall comply with the accessibility requirements specified in s. Comm 69.03 (3).

(b) If, upon inspection of an existing building or structure, it is found that its use has changed and that it does not comply with the requirements of the building code in effect at the time of change, it shall be made to comply with the code requirements in effect at the time of change in use.

(4) **REST ROOM PARITY.** Rest room parity applies to any facility where the public congregates which has a general capacity or seating capacity of 500 or more persons and meets the following conditions:

- (a) A new structural facility;
- (b) A new facility without a permanent structure;
- (c) An existing structural facility with alterations that affect 50% or more of the square footage of the facility;
- (d) An existing structural facility in which an addition has a square footage equal to or greater than 51% of the square footage of the existing structure; and
- (e) An existing facility with no permanent structure with an addition of land to the facility equal to or greater than 51% of the existing facility acreage.

Note: The percentage requirements established in this subsection shall apply to the accumulative sum of any remodeling or additions, or both undertaken after March 1, 1994. The addition of land applies only to that portion of added land which is specified as the expansion of the facility or event on that parcel and may not mean the total added land area to an existing facility or event.

(5) CONVERSION TO NONEXEMPT STATUS. A building previously exempt from this code under s. Comm 50.04 and that is being converted to a building which is not exempt shall conform to the version of this code that was in effect when the building was constructed, except as provided in sub. (3).

(6) TEMPORARY USE. A city, village, town or county fire or building code official may allow a building to be used temporarily in a manner that differs from the approved use for the building, or may approve a temporary building to be used by the public, subject to the following provisions:

- (a) The official shall determine the time frame within which the temporary use is permitted, based on the extent hazards are created by the temporary use. This time frame may not exceed 180 days, except the official may grant extensions for demonstrated cause.
- (b) Except as provided in par. (c), buildings considered for temporary use shall conform to the structural strength, fire safety, means of egress, light, ventilation, and sanitary requirements of this code as necessary to ensure the public safety, health and general welfare.
- (c) The official may require additional safety requirements for a temporary use as a trade-off for any safety provisions that may be lacking.
- (d) The official may terminate the approval for a temporary use at any time and order immediate discontinuance of the use or complete evacuation of the building.

History: Cr. Register, December, 1976, No. 252, eff. 1-1-77; am. (2), Register, August, 1985, No. 356 eff. 1-1-86; cr. (4), Register, August, 1993, No. 452, eff. 3-1-94; r. and recr. (3) (a) 2., Register, November, 1994, No. 467, eff. 12-1-94; am. (2), Register, December, 1995, No. 480, eff. 4-1-96; r. and recr. (2), Register, March, 1997, No. 495, eff. 4-1-97; cr. (5) and (6), Register, September, 2000, No. 537, eff. 10-1-00.

Comm 50.04 Buildings exempt from code requirements. This code does not apply to the following types of buildings:

- (1) One- and 2-family dwellings and outbuildings in connection therewith such as barns and private garages.
- (2) Buildings and structures that are on a farm premises and used exclusively for farming purposes, provided any use of the building or structure by the public consists only of consumers directly receiving farm commodities, substantially all of which have been planted or produced on the farm premises. In this application, "substantially all" means at least 90 percent of the commodities were planted or produced on the farm premises.
- (3) Buildings used primarily for housing livestock or for other agricultural purposes, located on research or laboratory farms of public universities or other state institutions.
- (4) Temporary buildings, used exclusively for construction purposes, not exceeding 2 stories in height, and not used as living quarters.
- (5) Buildings located on Indian reservation land held in trust by the United States.

(6) Buildings owned by or leased exclusively to the federal government. Buildings leased only in part to the federal government are not usually exempt unless the lease specifically provides for the long-term federal control of design and operating decisions. Buildings owned or controlled by other entities, such as the Postal Service or foreign governments, may also be exempt by operation of federal statutes or treaties. A nonfederal owner of a building that is exempt from this code under this subsection shall file a statement with the register of deeds which describes the exemption and describes the need for code compliance in the event the building is converted to a nonexempt use. The owner shall cause the statement to be recorded in a manner that will permit the existence of the statement to be determined by reference to the property where the building is located. The owner shall submit a copy of the recorded document to the department or its authorized representative.

(7) Bed and breakfast establishments as defined in s. Comm 51.01 (11a).

(8) Community-based residential facilities located in existing buildings and providing care, treatment and services to 3 to 8 unrelated adults.

(9) An adult family home certified under s. 50.032, Stats.

(10) A one- or 2-family dwelling in which a home occupation is located.

(11) A one- or 2-family dwelling used as a foster home, treatment foster home, or group home, or as a child caring institution having a capacity for 8 or fewer children, all as defined in s. 48.02, Stats.

Note: The definitions in s. 48.02, Stats., limit foster homes to no more than 4 children unless all the children are siblings, limit treatment foster homes to no more than 4 children, and limit group homes to no more than 8 children. Where permitted by the department of health and family services, a group home or a child caring institution having a capacity for 8 or fewer children may be located in a one- and 2-family dwelling as a community living arrangement, as defined in s. 46.03 (22), Stats.

(12) A one- or 2-family dwelling in which a public or private day care center for 8 or fewer children is located.

(13) Multifamily dwellings within the scope of ch. Comm 66, except as provided in s. Comm 66.60.

(14) A one-classroom school building operated by and for members of a bona fide religious denomination that has teachings and beliefs prohibiting use of products, devices, or designs which are needed to comply with this code.

(15) Any building or portion of a building that is exempted from this code by federal or state law.

Note: See s. Comm 50.03 (5) for the requirements that apply when an exempt building is converted to a nonexempt building.

History: Cr. Register, December, 1976, No. 252, eff. 1-1-77; am. (2) and cr. (5), Register, December, 1977, No. 264, eff. 1-1-78; cr. (6) to (8), Register, August, 1985, No. 356 eff. 1-1-86; cr. (9) and (10), Register, March, 1991, No. 423, eff. 4-1-91; cr. (11), Register, March, 1995, No. 471, eff. 4-1-95; correction in (9) made under s. 13.93 (2m) (b) 7., Stats., Register, March, 2000, No. 531; am. (2), (6), renum. (11) to be (13), cr. (11), (12), (14) and (15), Register, September, 2000, No. 537, eff. 10-1-00.

Comm 50.05 Existing buildings code. Buildings and structures erected prior to the effective date of the first building code (October 9, 1914) shall comply with the general orders on existing buildings, chs. Comm 75-79, issued by the department. Buildings and structures constructed after October 9, 1914, shall comply with the code in effect at the time.

History: Cr. Register, December, 1976, No. 252, eff. 1-1-77; correction made under s. 13.93 (2m) (b) 7., Stats., Register, October, 1996, No. 490.

Comm 50.055 Historic buildings code. Qualified historic buildings for which the owner has elected to use ch. Comm 70 are not required to comply with any of the provisions of chs. Comm 50 to 64 that are addressed by ch. Comm 70.

Note: The owner of a qualified historic building may select which code will apply to the building. The options include (1) complying with ch. Comm 70; (2) Historic Buildings Code; (3) complying with chs. Comm 50 to 64 - Building and Heating, Ventilating and Air Conditioning Code; (4) complying with the Building and Heating, Ventilating and Air Conditioning Code that was in effect at the time of the last addition, alteration, or change in use, provided the building and use have remained

unchanged since then; or (4) complying with chs. Comm 75 to 79—Existing Buildings Code, provided the building was constructed prior to October 9, 1914, and continues to have the same use as on that date.

History: Cr. Register, September, 2000, No. 537, eff. 10-1-00.

Comm 50.06 Local regulations. (1) **AUTHORITY.** This code shall not limit the power of cities, villages and towns to make, or enforce, additional or more stringent regulations, provided the regulations do not conflict with this code, or with any other rule of the department, or law.

(2) **ISSUANCE OF BUILDING PERMITS.** Pursuant to s. 66.036, Stats., if the proposed construction requires connection to a private onsite wastewater treatment system, a local building permit may not be issued unless conformance with s. Comm 83.25 (2) has first been determined.

Note: See appendix for a reprint of s. Comm 83.25 (2).

History: Cr. Register, December, 1976, No. 252, eff. 1-1-77; cr. (1), Register, May, 1980, No. 293, eff. 6-1-80; cr. (3), Register, April, 2000, No. 532, eff. 7-1-00; renum. (1) to be (Intro.) and r. (2), Register, September, 2000, No. 537, eff. 10-1-00; correction made under s. 13.93 (2m) (b) 1., Stats., Register, September 2000, No. 537.

Subchapter III — Design and Supervision

Comm 50.07 Design. Every new building, or alteration to a building, shall be designed in compliance with this code.

(1) **BUILDINGS CONTAINING NOT MORE THAN 50,000 CUBIC FEET TOTAL VOLUME.** The plans and specifications for every new building, or alteration to a building, containing not more than 50,000 cubic feet total volume, or addition to a building in which the volume of the addition results in the entire building containing not more than 50,000 cubic feet total volume, may be prepared by a registered architect, engineer, designer, contractor or an authorized agent.

(2) **BUILDINGS CONTAINING MORE THAN 50,000 CUBIC FEET TOTAL VOLUME.** The plans and specifications for every new building, or alteration to a building, containing more than 50,000 cubic feet total volume, or addition to a building in which the volume of the addition results in the entire building containing more than 50,000 cubic feet total volume, shall be designed as follows:

(a) *Building or structural design.* The plans and specifications for the design of the building or structure shall be prepared, signed and sealed by a Wisconsin registered architect or engineer.

(b) *Heating, ventilating and air conditioning design.* The plans and specifications for the heating, ventilating and air conditioning system shall be prepared, signed and sealed by a Wisconsin registered architect, engineer or designer.

(c) *Energy conservation design.* The plans and specifications for energy conservation design shall be prepared, signed and sealed by a Wisconsin registered architect, engineer or designer.

Note: See s. Comm 51.01 (139a) for definition of total volume.

Note: The above terms "registered architect, engineer or designer" mean registered architect, registered professional engineer or designer as defined by laws regulating the practice of engineering and architecture found in ch. 443, Stats. Designers are limited to the specific limitations outlined in s. A-E 5.06. See s. A-E 2.02 for rules pertaining to signing, sealing and dating of plans prepared by a registered architect, engineer or designer.

Note: According to s. 87.30, Stats., the construction or placement of every building, structure, fill or development placed or maintained within any flood plain is required to satisfy local or state regulations.

(3) **ANTENNAS AND SUPPORTING TOWERS EXCEEDING 200 FEET IN HEIGHT.** The plans and specifications for antennas and supporting towers exceeding 200 feet in height shall be prepared, signed and sealed by a Wisconsin registered architect or engineer.

History: Cr. Register, December, 1976, No. 252, eff. 1-1-77; am. (2) (a) and (b), cr. (2) (c), Register, December, 1978, No. 276, eff. 1-1-79; am. (1), Register, December, 1981, No. 312, eff. 1-1-82; cr. (3), Register, December, 1983, No. 336, eff. 1-1-84; am. (2) (c), Register, December, 1985, No. 360, eff. 1-1-86.

Comm 50.08 Plans, specifications and calculations prepared outside Wisconsin. Plans, specifications and calculations for buildings and structures under s. Comm 50.07 (2) and (3), may be prepared by an architect or engineer registered

outside of the state of Wisconsin, provided the following conditions are satisfied:

(1) **REGISTRATION.** The state agency or entity which registers the architect or engineer shall be an agency or entity recognized by the department of regulation and licensing as having equivalent standards for registration.

(2) **SEAL.** The plans, specifications and calculations shall bear the signature and seal or stamp of a registered architect or registered engineer.

(3) **CERTIFICATE.** A certificate, dated, signed and sealed by an architect or engineer registered in Wisconsin, shall be attached to the plans, specifications and calculations. The certificate shall indicate that the plans, specifications and calculations were prepared in a state other than Wisconsin by an architect or professional engineer registered in that state; describe the work performed by the Wisconsin registered architect or engineer; and include statements to the effect that the plans and specifications have been reviewed and comply with all applicable local and state buildings codes, and that the reviewing architect or engineer will be responsible for the supervision of construction in accordance with the requirements of s. Comm 50.10.

History: Cr. Register, December, 1976, No. 252, eff. 1-1-77; am. (intro.), Register, December, 1983, No. 336, eff. 1-1-84; renum. (1) and (2) to be (2) and (3) and am. (2), cr. (1), Register, March, 1991, No. 423, eff. 4-1-91.

Comm 50.10 Supervision. All constructions or installations under s. Comm 50.07 (2) and (3) shall be supervised by a Wisconsin registered architect or engineer, except that a Wisconsin registered designer may supervise the installation of heating, ventilating and air conditioning systems and illumination systems. The person responsible for supervision shall also be responsible for the construction and installation being in substantial compliance with the approved plans and specifications. Should the supervising architect, engineer, designer, or the department, be confronted with a nonconformance to the code during, or at the end of, construction, said parties, together with the designing architect, engineer or designer shall effect compliance or shall notify the department of the noncompliance.

(1) **DEFINITION.** Supervision of construction is a professional service, as distinguished from superintending of construction by a contractor, and means the performance, or the supervision thereof, of reasonable on-site observations to determine that the construction is in substantial compliance with the approved plans and specifications.

(2) **NAME OF SUPERVISING ARCHITECT, ENGINEER OR DESIGNER.** Prior to the start of construction, the owner of the building or structure, whose name shall be a part of or accompany all plans submitted for approval, or an authorized agent, shall designate in writing to the authority that issues plan approval the name and Wisconsin registration number of the architect, engineer or designer retained to supervise construction of the building or structure.

(3) **COMPLIANCE STATEMENT.** Prior to initial occupancy of a new building or addition, and prior to final occupancy of an alteration of an existing building, the supervising architect, engineer or designer shall file a written statement with the authority that issued plan approval certifying that, to the best of his or her knowledge and belief, construction of the portion to be occupied has been performed in substantial compliance with the approved plans and specifications. This statement shall be on a form prescribed by the department.

Note: The department forms required in this chapter are available from the Safety and Buildings Division at P.O. Box 7162, Madison, WI 53707-7162, or at telephone 608/266-3151 and 608/264-8777 (TTY). Some of the department forms are also available at the Safety and Buildings' web site at <http://www.commerce.state.wi.us>.

History: Cr. Register, December, 1976, No. 252, eff. 1-1-77; am. (intro.) and (2), Register, December, 1981, No. 312, eff. 1-1-82; am. (intro.), Register, December, 1983, No. 336, eff. 1-1-84; am. (2) and (3), Register, January, 1994, No. 457, eff. 2-1-94; am. (2) and (3), Register, September, 2000, No. 537, eff. 10-1-00.

Comm 50.11 Owner's responsibility. No owner may construct or alter any building or structure, or portion of a building

or structure, or permit any building or structure to be constructed or altered except in compliance with the provisions of chs. Comm 50 to 64. Compliance with the provisions of this section does not relieve the owner from compliance with the administrative rules established in other related codes.

Note: For definition of owner, refer to s. 101.01 (2) (e), Stats.

Note: Section Comm 50.07 specifies which plans and specifications must be prepared by a registered architect, engineer or designer. Section Comm 50.10 specifies which construction must be supervised by a registered architect, engineer or designer. Section Comm 50.10 (2) specifies the owner's responsibilities in informing the department of the construction supervisor. Section Comm 50.10 (3) specifies the requirements for filing completion statements prior to occupancy. Section Comm 50.12 specifies the requirements for plan submittal and approval. Section Comm 50.12 (5) requires submittal of a plan approval application form, and that form must be signed by the owner.

History: Cr. Register, December, 1976, No. 252, eff. 1-1-77; am. Register, January, 1994, No. 457, eff. 2-1-94.

Comm 50.115 Notice of intent. (1) A notice of intent for coverage under a Wisconsin Pollutant Discharge Elimination System (WPDES) General Permit No. WI-0067831-1 for storm water discharges associated with construction activities as required by 40 CFR part 122 shall be filed by the landowner for the construction project of a public building or a building that is a place of employment disturbing 5 or more acres of land. A construction site soil erosion control plan and storm water management plan shall be prepared in accordance with good engineering practices and the design criteria, standards and specifications outlined in the Wisconsin Construction Site Best Management Practices Handbook published by the department of natural resources (WDNR Pub. WR-222 November 1993 Revision).

Note: Copies of the Wisconsin Construction Best Management Practice Handbook are available through Wisconsin Department of Administration, Document Sales, 202 S. Thornton Ave., Madison, WI 53707.

(a) Prior to filing a notice of intent, a site specific soil erosion control plan and storm water management plan shall be prepared in accordance with ss. NR 216.46 and 216.47, respectively. If the soil erosion control plan or actions required by the plan fail to control the construction site soil erosion, the plan shall be amended or other actions taken to control construction site soil erosion.

(b) The landowner shall implement the soil erosion control plan throughout the construction period. Soil erosion control measures shall be installed and maintained at the construction site until the construction site is stabilized and a notice of termination is filed with the department stating that the site has undergone final site stabilization in accordance with s. NR 216.55.

(c) The landowner shall meet the reporting and monitoring requirements specified in s. NR 216.48.

(d) The department may inspect and enforce the provisions of this section in the event of violations. Additional information requested by the department to ascertain compliance with this section shall be submitted within the time period specified by the department.

(e) If the department of natural resources determines the construction site to be a significant source of storm water pollution, the department of natural resources may require the site to be covered by a individual WPDES storm water discharge permit.

Note: An industrial construction site covered by this section may also require an Industrial Storm Water Discharge Permit issued by the department of natural resources as provided in subch. II of ch. NR 216.

(2) A notice of intent shall be filed either with the department or with certified municipalities and counties authorized to review plans and perform inspections under s. Comm 50.21. Municipalities and counties shall file a copy of the notice of intent with the department. The notice of intent shall be filed on form 3400-161 published by the department of natural resources.

Note: Copies of form 3400-161 may be obtained from the department or the department of natural resources.

(3) The notice of intent form shall be completed in accordance with the instructions and filed at least 14 working days prior to commencement of construction.

(4) The department shall provide a summary of the notice of intent information collected to the department of natural resources.

(5) A landowner filing a notice of intent under this section shall be exempt from the department of natural resources' \$200 fee associated with filing form 3400-161.

History: Emerg. cr. eff. 11-4-94; cr. Register, August, 1995, No. 476, eff. 9-1-95.

Subchapter IV — Department Approval

Comm 50.12 Plan examination and approval.

(1) TYPES OF BUILDINGS. Except as provided in sub. (1t), plans and specifications for all buildings and structures in the following classifications shall be submitted to the department or its authorized representative, as provided in s. Comm 50.21 or 50.22, for examination and be approved before commencing work:

Note: See the scope of the occupancy chapters for examples of specific types of buildings covered in pars. (a) through (f).

Note: Section 101.12 (3) (h), Stats., prohibits local issuance of permits or licenses for construction or use of public buildings or places of employment until drawings and calculations have been examined and approved by the department.

(a) All buildings within the scope of ch. Comm 54, such as factories and office and mercantile buildings, unless waived as follows:

1. Except for public mausoleums, department examination and approval for factories, office and mercantile buildings containing less than 25,000 cubic feet total volume is waived; however, the buildings shall comply with the applicable requirements of this code.

2. Upon written request, the department may conduct an examination of preliminary mausoleum plans for compliance with this code. Results of this examination will be in writing. A fee may be charged for this type of examination. Complete plans and specifications as specified in sub. (3) shall be submitted in accordance with sub. (5) prior to construction.

(b) All buildings within the scope of ch. Comm 55, such as theaters and assembly halls.

(c) All buildings within the scope of ch. Comm 56, such as schools and other places of instruction.

(d) All buildings within the scope of ch. Comm 57, such as apartment buildings that exceed 60 feet in height or 6 stories, hotels, motels and other places of abode.

(e) All buildings within the scope of ch. Comm 58, such as health care facilities and places of detention, except that plans shall be submitted for double-celling in existing places of detention only where other alterations are being made that affect exiting, natural lighting, fire hazard or structural components. If the increased occupant load does not require physical alteration to the existing structure, plans are not required to be submitted.

(f) All buildings having occupancies within the scope of ch. Comm 59, which are hazardous occupancies, unless waived as follows:

1. Department examination and approval of plans shall be waived for a hangar accommodating one airplane; however, the building shall conform with the applicable requirements of this code.

2. Department examination and approval shall be waived for a storage garage which is less than 25,000 cubic feet in total volume; however, the building shall comply with the applicable requirements of this code.

(g) All buildings within the scope of ch. Comm 60, which are child day care facilities.

(h) All buildings within the scope of ch. Comm 61, which are community-based residential facilities (CBRF).

(i) All structures or buildings having occupancies within the scope of ch. Comm 62, which are specialty occupancies, unless waived as follows:

1. Except as provided in subd. 2., department plan examination and approval is waived for television and radio transmitting and receiving antennas, tents, outdoor theater screens, assembly seating facilities that are 5 rows or less in height, greenhouses containing less than 25,000 cubic feet of total volume, and mini-storage buildings containing less than 25,000 cubic feet of total volume; however, these structures and buildings shall comply with the applicable structural and other requirements of this code.

2. Plan examination and approval is required for the installation of an assembly seating facility within a building. The plans shall consider loadings that include, but are not limited to, effects on structural components, class of construction, room capacity, exit width, and plumbing fixtures. For an assembly seating facility that is 5 rows or less in height, the plans need not include the structural details for the seating facility.

(1m) APPROVAL WAIVED. Department plan examination and approval is waived for water tanks, display signs, observation towers, docks, piers, wharves, and other similar structures and buildings; however, these structures and buildings shall comply with the applicable structural and other requirements of this code.

(1t) EXEMPTION THROUGH DESIGN AND SUPERVISION BY REGISTERED PROFESSIONALS. (a) Department plan examination and approval is waived for the following buildings or components thereof if the plans and specifications are designed by a registered individual in accordance with s. Comm 50.07 (2) or 50.08, and if the construction or installation of the building or components thereof is supervised by a registered individual in accordance with s. Comm 50.10:

1. Buildings containing 25,000 to less than 50,000 cubic feet total volume and occupied as a storage garage, greenhouse, mini-storage, or any other use under the scope of ch. Comm 54.

2. Buildings specified in sub. (1) (b) to (f)1., (g) and (h) that contain less than 25,000 cubic feet total volume.

(b) Where the exemption in par. (a) is elected, a notice shall be filed with the department or its authorized representative, that identifies the building location, the name and address of the building owner, and the name and Wisconsin registration number for the designer and supervising professional. A notice filed with the department under this paragraph shall include the fee specified in s. Comm 2.31 (1) (g).

(2) TYPES OF PLAN APPROVAL. Except as provided in sub. (3) (g), the following types of plans shall be submitted to the department or its authorized representative, as provided in s. Comm 50.21 and 50.22, for examination and be approved before construction is commenced:

(a) General building plans.

(b) Structural plans and structural component plans.

(c) 1. Heating and ventilating plans; and

2. Data and information relative to the requirements of chs. Comm 63 and 64, for the replacement of a major piece of heating, ventilating or air conditioning equipment, where the equipment to be installed is not identical or closely similar to the equipment being replaced.

(d) Alteration plans for existing buildings, except for those alterations involving changes in interior finishes only.

(e) Revisions to previously examined plans.

(f) Industrial exhaust system plans within government-owned buildings.

Note: See s. Comm 64.54 (3) relating to the types of exhaust ventilation systems requiring plan submittal.

(g) Spray booth plans (government-owned buildings only).

(h) Footing and foundation plans (see s. Comm 50.13).

(i) Assembly seating facility plans.

(j) Fire escape plans.

(k) Fire prevention, detection and suppression systems as required by the department.

Note: Refer to the Safety and Buildings Division's Plan Submittal Kit (SBD-8927) for detailed information concerning the submittal requirements for fire system plans. The kit is available at no charge from the Safety and Buildings Division, P.O. 7162, Madison, WI 53707-7162, telephone 608/266-3151 and 608/264-8777 (TTY).

(3) PLANS AND SPECIFICATIONS. Except as provided in par. (g), at least 4 complete bound sets of plans, which are clear, legible and permanent copies, and one copy of specifications shall be submitted for examination and be approved before commencing construction. The plans shall be bound in a manner that enables them to be reviewed without removing the binding. The plans and specifications shall contain at least the following information:

Note: Also see sub. (5) (b) note.

(a) *General.* All plans shall contain the name of the owner and the address of the building. The name and seal of the architect, engineer or person who prepared the plans shall appear on the title sheet, in accordance with s. A-E 2.02, Wis. Adm. Code.

(b) *General building plans.* The general building plans shall include the following:

1. Plot plan. a. The location of the building with respect to property lines and lot lines and adjoining streets, alleys and any other buildings on the same lot or property shall be indicated on the plot plan. For recycling space designated adjacent to a building, as specified in s. Comm 52.24, the area and dimensions shall be indicated on the plot plan. A small scale plot plan shall be submitted on a 8½" x 11" sheet for projects containing multiple buildings. For purposes of this requirement, a plot plan does not have to be a certified survey.

b. The plot plan shall clearly indicate the location of the accessible building, its accessible entrances and the exterior accessible route to, from and between all accessible parking spaces, recreational and public facilities and areas on the site, public transportation stops adjacent to the property, public streets or sidewalks and if provided, passenger loading zones. The plans shall also indicate the size and location of the accessible parking spaces and the gradient or slope information for all walks and ramps on the accessible route.

2. Floor plans. Floor plans shall be provided for each floor. The size and location of all rooms, doors, windows, fire walls, toilet facilities, structural features, exit passageways, exit lights, fire alarms, standpipes, stairs and other pertinent information, including but not limited to adequate space within a building designated for collection, separation and temporary storage of recyclable materials, shall be indicated. Schematic exit plans shall be provided for large buildings, indicating normal paths of egress.

3. Elevations. The elevations shall contain information on the exterior appearance of the building and indicate the location and size of doors, windows, roof shape, chimneys, exterior grade, footings and foundation walls, and include information about the exterior materials.

4. Sections and details. Sections and details shall include information to clarify the building design.

5. Interior barrier-free design information. The general building floor plans, elevations and sections shall clearly show the following:

a. All accessible routes through accessible buildings, facilities, tenant spaces and living units.

b. The design and location of all interior and exterior ramps, including the gradient or slope information.

c. The areas of rescue assistance in multilevel buildings, including dimensions of the area and the fire resistive construction details.

d. The type and location of elevator or mechanical lifting equipment and, where applicable, the design and construction of the vertical shaft.

e. The design of bathrooms, toilet rooms and unisex toilet rooms, including door clearances, lavatory or vanity design, plumbing fixture mounting heights, turnaround spaces, clear

spaces required for plumbing fixtures, the size and arrangement of toilet compartments and other toilet room equipment such as, but not limited to, mirrors, soap dispensers and hand dryers.

(c) *Heating, ventilating and air conditioning plans.* Heating, ventilating and air conditioning plans shall indicate the layout of the system, including location of equipment and size of all piping, ductwork, dampers (including fire dampers), chimneys, vents and controls. The quantity of outside air introduced to each zone, and the quantity of supply air and exhaust air for each room shall be listed on the plans. The type of equipment and capacity (including the input and output) shall be indicated on the plans or equipment schedules, unless indicated in the specifications. Justification for the number of persons used as the basis for the HVAC system design shall be provided when required by s. Comm 64.05 (5).

(d) *Specialty plans.* Specialty plans for spray booths, special exhaust systems, assembly seating facilities, fire escapes and special structural systems shall include pertinent information with respect to the design and construction of the specialty.

(e) *Specifications.* The specifications shall be properly identified with the drawings and describe the quality of the materials and the workmanship.

(f) *Schedules.* Schedules shall be provided which contain information pertinent to doors, room finishes, equipment, and the use of all rooms and the number of occupants accommodated therein, unless this information is indicated on the plans.

(g) *Structural component plans.* 1. One set of plans for structural components, as specified in sub. (4) (a), shall be submitted for examination before commencing construction, and one set shall be kept at the building site during construction.

2. Structural component plans for buildings containing more than 50,000 cubic feet total volume, or for additions in which the volume of the addition results in the entire building containing more than 50,000 cubic feet total volume, shall comply with all of the following:

a. Each set of plans shall be signed and sealed in accordance with s. Comm 50.07 (2).

b. Plans that are signed and sealed by someone other than the building designer of record shall include a signed or initialed indication from the building designer that the component plans are compatible with the building plans.

Note: Original drawings are not considered a substitute for permanent prints.

Note: Duplicate information need not be submitted when heating, ventilating, air conditioning and building plans are submitted simultaneously.

Note: For pit depth and overhead clearance requirements applicable to design of elevator hoistways, see ch. Comm 18, Elevator Code.

Note: Plans for swimming pool installations are examined by the department.

(4) **DATA REQUIRED.** All plans submitted for approval shall be accompanied by sufficient data and information for the department to judge if the design of the building, the capacity of the equipment, and the performance of the system will meet the requirements of this code. The following data shall be submitted:

(a) *Structural data.* Sample structural calculations, including assumed bearing value of soil, live loads and itemized dead loads, unit stresses for structural materials, typical calculations for slabs, beams, girders, columns and trusses shall be submitted. Typical wind and bracing calculations and diagrams including the manner in which shear transfer is made between resisting elements shall also be included. Complete structural calculations shall be furnished upon request of the department or other authorized approving official.

1. The building designer shall submit the following minimum information for structural components such as but not limited to wood trusses, precast concrete, laminated wood members, steel joists and steel girders when the component fabricator is specified as being responsible for the component design:

a. Structural framing plan;

b. Bearing support and connection details of the component to the structure;

c. Design loads, including location and magnitude of: uniform superimposed dead and live loads; concentrated dead and live loads; nonuniform snow loads; wind and bracing loads for component system; and wind, bracing and gravity forces required to be developed at interfaces with other materials;

d. Required fire rating;

e. Outside configuration of components; and

f. Permanent bracing system.

2. The building designer shall also submit the following information with the initial building plan submittal or the component plan submittal:

a. A framing plan showing all members and labels and special installation (e.g., handling and erection) instructions and any required permanent bracing required which was the basis for the component design;

b. Information regarding the member design of the following structural components: web configuration, stress diagram or tabulation of axial force in the members, member size, grade of lumber, fabricated splices and member bracing for wood trusses; web configuration, stress diagram or tabulation of axial force in the members, member size, steel yield, fabricated splices and member bracing for steel joists and joist girders subjected to nonuniform loading; specified concrete strengths, prestressing data including final effective forces and centroids, mild reinforcing including release and confinement steel, shear reinforcing, and stripping, transportation and erection handling points for precast concrete members; species of wood, bending stress of wood, adhesive and member sizes for laminated wood members; and

c. Information pertaining to the design of connections within or between like components for the following structural components: web and chord connection details and connector plate holding values for wood trusses; web and chord connection details for steel joist and joist girders subjected to nonuniform loading; bearing confinement steel, dapped end reinforcing, corbel reinforcing, bearing pads, and loose and embedded connection steel including welding and bolting requirements for precast concrete members; member connection and bearing details for laminated wood members.

3. For the purposes of this paragraph, the department does not consider truss layout plans or truss erection plans as architectural practice or engineering practice, and therefore, such plans are not required to be signed and sealed or stamped in accordance with s. Comm 50.07 or 50.08.

4. Information regarding reinforcement, concrete strength, fire resistive ratings for precast concrete components may be provided in either the specifications or calculations furnished with the precast concrete plans.

(b) *Energy conservation data.* Calculations and specifications shall be submitted in accordance with s. Comm 63.01 for the types of projects outlined in s. Comm 63.001 on forms provided by the department or other forms approved by the department.

Note: See A50.12 of the appendix for sample copies of forms.

(c) *Heating and ventilating data.* A description of the construction for the walls, floors, ceilings and roof, and the transmission coefficients of the construction materials shall be furnished. The calculations shall include heat losses for the individual rooms (including transmission and infiltration and/or ventilation losses, whichever are greater), a summary of the total building heat loss expressed in Btu/hour or watts, heat gain calculations for air conditioning systems, ventilation calculations including outside air requirements for each space and ventilation system expressed in cubic feet per minute or liters per second, and percent of outside air at maximum and minimum flow rates when the building is occupied.

Note: If the code does not specify a required calculation method, the department will accept as the basis for calculations and design data, the methods and standards recommended by the Mechanical Contractors' Association of America; the American Society of Heating, Refrigerating and Air Conditioning Engineers; and the Institute of Boiler and Radiator Manufacturers.

(d) *Data for recycling space.* Verifiable data or calculations and specifications shall be submitted in accordance with s. Comm 52.24 for determining adequate space for the separation, temporary storage and collection of recyclable materials, unless the space designated is based on the requirements identified in this code.

(dm) *Elevator and mechanical lift data.* When an elevator, limited-use elevator, residential elevator, vertical wheelchair lift, inclined wheelchair lift, stairway chairlift or other mechanical lifting device is to be installed in a public building or place of employment, the following information, when applicable, shall be included on the building plans and submitted to the department for review:

1. Size of cabs or platforms for elevators, limited-use elevators, residential elevators and wheelchair platform lifts.

Note: See chs. Comm 18 and 69 for the minimum cab and platform sizes.

2. Rating and construction of vertical shafts for elevators, limited-use elevators, residential elevators and vertical wheelchair lifts.

3. Door clearances to elevators, limited-use elevators, residential elevators and vertical wheelchair lifts.

4. Maneuverability clearances at elevators, limited-use elevators, residential elevators and wheelchair platform lifts.

Note: See chs. Comm 18 and 69 for maneuverability clearances at doors.

5. The accessible route to the methods of vertical circulation provided in a building or facility.

6. Location and width of all exits and stairways in a building or facility when an inclined wheelchair platform lift or stairway chairlift is installed. The mechanical lifting devices in their operational position shall not infringe into the minimum exit width required for the building or facility.

Note: The minimum exit width required for a building or facility is based on the capacity of the building or facility. See the applicable sections of chs. Comm 50 to 64 for determining the capacity and exit width.

(e) *Data for multiple-tenant or owner buildings, or for additions to existing buildings.* Submittals for individually owned or leased spaces within multiple-tenant or owner buildings, or for additions to existing buildings, shall either be complete enough to be reviewed independently from other records, or be filed with an office having a copy of such other records. These other records include but are not limited to the following:

1. A building shell plan.
2. An exiting plan showing all common exits and stairways.
3. A plan showing all fire division walls.
4. A plan showing the location and number of public drinking water and sanitary facilities.

5. A plan showing the location of individual spaces within the building.

6. All conditions of previous plan and variance approvals, either for the building shell or for other spaces within the building, that restrict or otherwise affect any construction aspects regulated by this code or ch. Comm 69, for the individual spaces included in the submittal.

(f) *Additional data.* When requested, additional data pertaining to design, construction, materials and equipment shall be submitted to the department for approval.

(5) **APPLICATION FOR APPROVAL.** A plan approval application form shall be included with the plans submitted to the department for examination and approval. The department shall review and make a determination on an application for plan review within 15 business days of receipt of the application and all forms, fees, plans and documents required to complete the review as specified in s. Comm 2.07 (3).

Note: The department forms required in this chapter are available from the Safety and Buildings Division at P. O. Box 7162, Madison, WI 53707-7162, or at telephone 608/266-3151 and 608/264-8777 (TTY). Some of the department forms are also available at the Safety and Buildings' web site at www.commerce.state.wi.us.

(a) *Conditional approval.* If, upon examination, the department determines that the plans and the application for approval

substantially conform to the provisions of this code, a conditional approval, in writing, will be granted. All non-code-complying conditions stated in the conditional approval shall be corrected before or during construction.

Note: The plan examination and approval by the department does not constitute an approval to proceed with construction prior to obtaining any permits or approvals that are required by a local unit of government.

(b) *Denial of approval.* If the department determines that the plans or the application do not substantially conform to the provisions of this code, the application for conditional approval will be denied, in writing.

Note: A letter will be sent to the designer and the owner of record with a statement relating to the examination of the plans and citing the conditions of approval or denial. The plans will be dated and stamped "conditionally approved" or "not approved," whichever applies. The department will retain one copy of the plans for all projects. The department will forward one copy of the plans for projects of less than 100,000 cubic feet and alterations of less than \$100,000 estimated cost to the state building inspector of record. The remaining plans will be returned to the person designated on the plans approval application.

(6) **REVISIONS TO APPROVED PLANS.** (a) 1. All revisions and modifications which involve provisions of this code and which are made to plans or specifications that have previously been granted approval by the department or its authorized representative, shall be submitted for review to the office that granted the approval.

2. All revisions and modifications to the plans shall be approved in writing by the department or its authorized representative prior to the work involved in the revision or modification being carried out.

(b) A revision or modification to a plan, drawing or specification shall be signed and sealed in accordance with s. Comm 50.07 (2), if applicable.

Note: Section Comm 50.12 was revised in December, 1995, effective April 1, 1996. On April 6, 1996 the department of industry, labor and human relations published an emergency rule stating that the effective date of the December, 1995 rule revision was delayed. A permanent rule was adopted in December, 1996 stating that the revised text of s. Comm 50.12, as published, would be effective April 1, 1997.

History: Cr. Register, December, 1976, No. 252, eff. 1-1-77; am. (1) (g) 1, Register, December, 1977, No. 264, eff. 1-1-78; am. (4) (b), Register, May, 1978, No. 269, eff. 7-1-78; am. (1) (g) (intro.), Register, December, 1978, No. 276, eff. 1-1-79; am. (2) (c) 1., (3) (intro.) and (4) (b), cr. (2) (k), Register, January, 1980, No. 289, eff. 2-1-80; am. (1) (b) and (d), (2) (c) 2., (d) and (i), (3) (d), (4) (a), renum. (1) (e), (f) and (g) to be (1) (f), (g) and (i) and am. (1) (f) and (i) (intro.), cr. (1) (e) and (h), Register, December, 1981, No. 312, eff. 1-1-82; r. and recr. (1) (i), am. (4) (a) 2. intro., Register, December, 1983, No. 336, eff. 1-1-84; am. (5) (intro.), Register, January, 1985, No. 349, eff. 2-1-85; am. (1) (intro.) and (2) (intro.), Register, April, 1985, No. 352, eff. 5-1-85; am. (4) (a) 1., Register, August, 1985, No. 356, eff. 1-1-86; r. (2) (k), Register, December, 1985, No. 360, eff. 1-1-86; r. and recr. (1) (f), (i), (2) (c) and (f), am. (3) (intro.), (b) 1. and (4) (b), cr. (4) (a) 3. and 4. and (6), Register, March, 1991, No. 423, eff. 4-1-91; am. (1) (a) 1., cr. (1) (a) 2., Register, March, 1992, No. 435, eff. 4-1-92; am. (5), Register, June, 1992, No. 438, eff. 7-1-92; am. (3) (b) 1. and 2., renum. (4) (d) to be (e), cr. (4) (d), Register, October, 1992, No. 442, eff. 5-1-93; am. (1) (e), (i) 2. c., (3) (intro.) and (a), (4) (a) 2. b. and (b), Register, January, 1994, No. 457, eff. 2-1-94; cr. (4) (dm), Register, March, 1994, No. 459, eff. 4-1-94; renum. (3) (b) 1. to (3) (b) 1. a., cr. (3) (b) 1. b., 5., Register, November, 1994, No. 467, eff. 12-1-94; reprinted to restore dropped copy in (3) (b) 5., Register, January, 1995, No. 469; am. (1) (d), Register, March, 1995, No. 471, eff. 4-1-95; am. (4) (b), (c), December, 1995, No. 480, eff. 4-1-96; correction in (5) (intro.) made under s. 13.93 (2m) (b) 7., Stats., Register, October, 1996, No. 490; am. (4) (c), Register, December, 1996, No. 492, eff. 4-1-97; r. and recr. (3) (c), (4) (b) and (c), Register, March, 1997, No. 495, eff. 4-1-97; r. and recr. (4) (dm), Register, April, 1998, No. 508, eff. 5-1-98; am. (1) (intro.), (a) (intro.), 2., (b) to (f) (intro.), (g), (h), (i) 1., (2) (intro.), (b), (c) 2., (3) (intro.), (5) (intro.), (a), (6) (a) 1. and 2., cr. (1) (i) (intro.), (1m), (1t), (2) (k), (3) (g), (4) (e), r. and recr. (1) (i) 2. and renum. (4) (e) to be (4) (f), Register, September, 2000, No. 537, eff. 10-1-00.

Comm 50.13 Footing and foundation approval.

(1) The department or its authorized representative, as provided in s. Comm 50.21 and 50.22, may conditionally approve footing and foundation plans to permit construction of footings and foundations prior to the examination and approval of the complete plans upon submission of:

- (a) A plan approval application form, SBD-118;
- (b) At least 4 bound sets of footing and foundation plans which:

1. Include a plot plan; and
2. Are signed and sealed in accordance with s. Comm 50.07 or 50.08, if applicable.

(c) At least one set of:

1. Schematic floor plans indicating the exits;

2. Building elevations;
 3. Itemized structural loads; and
 4. Structural footing and foundation calculations; and
- (d) The fee as specified in ch. Comm 2.

(2) The department or its authorized representative shall review and make a determination on an application for footing and foundation approval within 15 business days of receipt of the application and all forms, fees, plans, and documents required to complete the review.

History: Cr. Register, December, 1976, No. 252, eff. 1-1-77; am. Register, May, 1980, No. 293, eff. 6-1-80; am. Register, January, 1985, No. 349, eff. 2-1-85; am. Register, April, 1985, No. 352, eff. 5-1-85; r. and recr. register, March, 1991, No. 423, eff. 4-1-91; correction in (1) (d) made under s. 13.93 (2m) (b) 7., Stats., Register, June, 1993, No. 450; correction in (1) (d) made under s. 13.93 (2m) (b) 7., Stats., Register, October, 1996, No. 490; am. (1) (intro.) and (2), Register, September, 2000, No. 537, eff. 10-1-00.

Comm 50.14 Permission to start construction.

(1) The department or its authorized representative, as provided in s. Comm 50.21 or 50.22, may issue a permission to start construction for the footings and foundations upon submission of:

- (a) A completed plan approval application form, SBD-118;
- (b) 1. At least 4 bound sets of building plans and one copy of specifications; or
2. At least 4 bound sets of footing and foundation plans and the information specified in s. Comm 50.13 (1).
- (c) A written request by the owner to start construction; and
- (d) Fees as specified in ch. Comm 2.

(2) The holders of the permission form shall proceed at their own risk without assurance that a conditional approval for the building will be granted.

(3) The department shall review and make a determination on an application for permission to start construction within 3 business days of receipt of the application and all forms, fees, plans and documents required to complete the review.

History: Cr. Register, December, 1976, No. 252, eff. 1-1-77; am. Register, May, 1980, No. 293, eff. 6-1-80; am. Register, December, 1983, No. 336, eff. 1-1-84; am. Register, January, 1985, No. 349, eff. 2-1-85; am. Register, April, 1985, No. 352, eff. 5-1-85; r. and recr. Register, March, 1991, No. 423, eff. 4-1-91; correction in (1) (d) made under s. 13.93 (2m) (b) 7., Stats., Register, June, 1993, No. 450; correction in (1) (d) made under s. 13.93 (2m) (b) 7., Stats., Register, October, 1996, No. 490; am. (1) (intro.) and (c), Register, September, 2000, No. 537, eff. 10-1-00.

Comm 50.15 Evidence of plan approval. The architect, engineer, designer, builder, manufacturer or owner shall keep at the building site one set of plans bearing the stamp of conditional approval and a copy of the specifications. The plans shall be open to inspection by the department, its authorized representative or the municipality.

History: Cr. Register, December, 1976, No. 252, eff. 1-1-77; am. Register, May, 1980, No. 293, eff. 6-1-80; am., Register, September, 2000, No. 537, eff. 10-1-00.

Comm 50.155 Sprinkler documents. (1) PLANS. (a)

1. Except as provided in subd. 2., where automatic fire sprinkler systems are to be installed or altered, sprinkler plans and specifications shall be present at the job site and made available, upon request, to the department, its agent or local governmental agencies exercising jurisdiction.

2. a. When a project involves the alteration or addition of 20 or less sprinkler heads to an existing automatic fire sprinkler system, sprinkler plans and specifications shall not be required to be present at the job site or made available, unless required by local ordinance.

b. When sprinkler plans and specifications are not provided for a project involving the alteration or addition of 20 or less sprinkler heads to an existing automatic fire sprinkler system, the automatic fire sprinkler contractor responsible for the work shall provide a written description of the type and scope of the work. The description shall be included with the material and test certificate, if required. The description shall be made available, upon request,

to the department, its agent or local governmental agencies exercising jurisdiction.

(b) The sprinkler plans at the installation site shall be:

1. Signed and sealed in accordance with s. A-B 2.02 by an architect, engineer or sprinkler designer who is registered by the department of regulation and licensing; or

2. Signed, including license number, and dated by an automatic fire sprinkler contractor who is responsible for the installation of the sprinklers and who is licensed by the department of commerce.

(c) Where automatic fire sprinkler plans are required by local ordinance to be reviewed and approved by a local governmental agency, the sprinkler plans at the installation site shall bear evidence of that approval.

(d) The plans for the automatic fire sprinkler system to be at the installation site shall include at least:

1. The name of the:
 - a. Owner of the building; and
 - b. Occupant or occupants in the building;
2. The location or address of the building;
3. A full height cross section through the building;
4. The location within the building of:
 - a. Partitions, walls, and fire walls;
 - b. Concealed spaces, closets, attics and bathrooms;
 - c. Sprinklers;
 - d. Alarms;
 - e. Pumps, valves, drain pipes and test connections; and
 - f. Pipe hangers and supports.
5. The occupancy class of each area or room within the building;
6. The sources of water supply, including the static pressure, residual pressure, the flow and the dates and time of determination for each;

7. The location and size of:

- a. All above ground and underground piping; and
- b. Hose outlets.
8. The number of sprinklers on each riser per floor; and
9. The relative elevations of sprinklers, junction points, and supply points;

(e) The specifications for the automatic fire sprinkler system to be at the installation site shall include at least:

1. The type of materials, and devices that comprise the sprinkler system;
2. The settings of pressure reducing valves; and
3. Type and amount of antifreeze solutions being employed, if any.

(2) SPRINKLER MATERIAL AND TEST CERTIFICATES. (a) Where automatic fire sprinkler systems have been installed or altered, completed sprinkler material and test certificates shall be made available, upon request, to the department, its agent or local governmental agencies exercising jurisdiction.

(b) A sprinkler material and test certificate shall provide at least the information as enumerated in NFPA 13, s. 8-1 or NFPA 13R, s. 2-1, depending upon the type of sprinkler system.

History: Cr. Register, June, 1993, No. 450, eff. 7-1-93; am. (2) (b), Register, January, 1994, No. 457, eff. 2-1-94; correction in (1) (b) 2. made under s. 13.93 (2m) (b) 7., Stats., Register, October, 1996, No. 490.

Comm 50.16 Revocation of approval. The department may revoke any approval, issued under the provisions of this code, for any false statements or misrepresentation of facts on which the approval was based.

History: Cr. Register, December, 1976, No. 252, eff. 1-1-77.

Comm 50.17 Expiration of plan approval and extension of plan approval. (1) EXPIRATION OF PLAN APPROVAL. (a)

Building shell. Except as provided in par. (e), plan approval by the department or its authorized representative for new buildings and building additions shall expire 2 years after the approval date indicated on the approved building plans if the building shell is not closed in within those 2 years.

(b) **Occupancy.** Except as provided in sub. (2), plan approval by the department or its authorized representative for new buildings and building additions shall expire 3 years after the approval date indicated on the approved building plans if the building is not ready for occupancy within those 3 years.

(c) **Alterations.** Except as provided in sub. (2), plan approval by the department or its authorized representative for interior building alterations shall expire 1 year after the approval date indicated on the approved building plans if the alteration work is not completed within that year.

(d) **HVAC construction only.** Except as provided in sub. (2), plan approval by the department or its authorized representative for heating, ventilating, or air conditioning construction that does not include any associated building construction shall expire 1 year after the approval date indicated on the approved plans if the building or building area affected by the plans is not ready for occupancy within that year.

(e) **Mausoleums.** Plan approval by the department or its authorized representative for mausoleums within the scope of s. 440.92 (2) (e), Stats., shall expire 3 years after the date indicated on the approved building plans of the building shell if not closed within those 3 years.

(2) EXTENSION OF PLAN APPROVAL. Upon request and payment of the fee specified in ch. Comm 2, the expiration dates in sub. (1) (b), (c), and (d) shall be extended for one 1-year period provided the request is submitted prior to expiration of the original approval.

Note: According to s. 66.05 (1) (a), Stats., the local governmental body or building inspector may order the razing of buildings or portions thereof, where there has been a cessation of normal construction for more than 2 years.

History: Cr. Register, December, 1976, No. 252, eff. 1-1-77; r. and rec. Register, August, 1986, No. 368, eff. 9-1-86; correction in (2) made under s. 13.93 (2m) (b) 7., Stats., Register, June, 1993, No. 450; r. and rec., Register, March, 1995, No. 471, eff. 4-1-95; correction in (2) made under s. 13.93 (2m) (b) 7., Stats., Register, October, 1996, No. 490.

Comm 50.175 Department limitation. A conditional approval of a plan by the department shall not be construed as an assumption of any responsibility for the design or construction of the building.

History: Cr. Register, August, 1986, No. 368, eff. 9-1-86; am., Register, September, 2000, No. 537, eff. 10-1-00.

Comm 50.18 Inspections. (1) ON-SITE. Inspections shall be conducted by an authorized representative of the department to determine whether or not the construction or installations conform to the conditionally approved plans, the conditional approval letter, and the provisions of chs. Comm 50 to 64.

Note: Municipalities and counties certified under s. Comm 50.21 and 50.22 are authorized representatives of this department to make the inspections specified in this section.

Note: A list of the municipalities and counties providing building inspections under this section is available from the Safety and Buildings Division at P.O. Box 7162, Madison, WI 53707-7162, or at telephone 608/266-3151 and 608/264-8777 (TTY), or at the Safety and Buildings' web site at www.commerce.state.wi.us.

(2) IN-PLANT. Manufacturers of multi-family dwellings shall contract with the department or an independent inspection agency to conduct in-plant inspections to assure that the manufactured multi-family dwellings are in compliance with the plans approved by the department. All inspections shall be performed by a certified commercial building inspector.

(3) PUBLIC MAUSOLEUM. Within 30 days after receiving written notice from a cemetery authority that the construction or conversion of a public mausoleum has been completed, the department or authorized agent shall inspect the public mausoleum and provide written notification of violations. Except as provided in s. 157.12 (2) (b), Stats., public mausoleum spaces may not be sold prior to approval by the department or its authorized agent.

Note: Sale of public mausoleum spaces is permitted prior to departmental approval in accordance with the requirements of the department of regulation and licensing.

History: Cr. Register, December, 1976, No. 252, eff. 1-1-77; am. Register, May, 1980, No. 293, eff. 6-1-80; cr. (3), Register, March, 1992, No. 435, eff. 4-1-92; am. (1), Register, October, 1992, No. 442, eff. 11-1-92; am. (2), Register, October, 1996, No. 490, eff. 11-1-96.

Comm 50.19 Building product approvals. (1) VOLUNTARY APPROVAL. (a) Materials, equipment and products regulated by this code may receive a written approval from the department indicating code compliance.

(b) 1. Approval of materials, equipment and products shall be based on sufficient data, tests and other evidence that prove the material, equipment or product is in compliance with the standards specified in this code.

2. Tests, compilation of data, and calculations shall be conducted by a qualified independent third party.

(2) ALTERNATE APPROVAL. (a) Materials, equipment and products which meet the intent of this code and which are not approved under sub. (1) shall be permitted if approved in writing by the department.

(b) 1. Approval of materials, equipment and products shall be based on sufficient data, tests and other evidence that prove the material, equipment or product meets the intent of the standards specified in this code.

2. Tests, compilation of data, and calculations shall be conducted by a qualified independent third party.

(3) EXPERIMENTAL APPROVAL. (a) The department may allow use of an experimental material, equipment or product for the purpose of proving compliance with the intent of this code.

(b) The department may require the submission of any information deemed necessary for review.

(c) The department may limit the number of applications it will accept for approval of experimental materials, equipment or products.

(d) Installations of a material, equipment or product under an experimental approval shall comply with all of the following:

1. Plans detailing the installation for each project where the experimental material, equipment or product is to be used shall be submitted to the department in accordance with s. Comm 50.12.

2. A copy of the experimental approval shall be attached to the submitted plans and approved plans.

3. a. A letter of consent from the owner of the installation shall be attached to the submitted plans and approved plans.

b. The letter under subpar. a. shall acknowledge that the owner has received and read a copy of the experimental approval and is in compliance with all conditions of the approval.

4. If a supervising professional is not required for the project by s. Comm 50.10, a person responsible for construction of the project shall be designated in writing by the owner.

5. The supervising professional or person designated as responsible for the construction of the project shall, upon completion of construction, certify in writing to the department that the installation is in compliance with the experimental approval, approved plans, specifications and data.

(e) 1. Any onsite inspections shall be performed by the department, or other person approved by the department, at time intervals as specified by the department, but not less than once a year. The inspector shall write an inspection report.

2. The department may assess a fee for each inspection.

(f) Five years and 6 months after the date of the completed installation, the department shall order the removal of the experimental material, equipment or product, or issue an approval for the material, equipment or product.

(g) Paragraphs (e) and (f) do not apply to an experimental system if this code is revised to include or enable the experimental system to conform to the intent of this code.

(4) REVIEW, APPROVAL AND REVOCATION PROCESSES. (a) 1. Upon receipt of a fee and a written request, the department may issue an approval for a material, equipment or product.

2. The department shall review and make a determination on an application for approval after receipt of all forms, fees, plans and information required to complete the review.

3. For voluntary and alternate approvals, a determination shall be made within 40 business days of receipt of all required materials.

4. For an experimental approval, the determination shall be made within 6 months of receipt of all required materials.

(b) 1. The department may include specific conditions in issuing an approval, including an expiration date for the approval.

2. Violations of the conditions under which an approval is issued shall constitute a violation of this code.

(c) If the department determines that the material, equipment or product does not comply with this code or the intent of this code, or that an experimental approval will not be issued, the request for approval shall be denied in writing.

(d) If an approved material, equipment or product is modified, the approval shall be considered null and void, unless the material, equipment or product is resubmitted to the department for review and approval is granted.

(e) 1. The department may revoke or deny an approval for any false statements or misrepresentations of relevant facts or data, unacceptability of a third party providing information, or as a result of material, equipment or product failure.

2. The department may re-examine an approved material, equipment or product and issue a revised approval at any time.

(f) The department may revoke an approval if the department determines that the material, equipment or product does not comply with this code or the intent of this code due to a change in the code or department interpretation of the code.

(g) An approval issued by the department may not be construed as an assumption of any responsibility for defects in design, construction or performance of the approved material, equipment or product nor for any damages that may result.

(h) Fees for the review of a material, equipment or product under this section and any onsite inspections shall be submitted in accordance with ch. Comm 2.

History: Cr. Register, December, 1976, No. 252, eff. 1-1-77; am. Register, January, 1985, No. 349, eff. 2-1-85; renm. to be (1), cr. (2), Register, March, 1991, No. 423, eff. 4-1-91; am. (2) (b) 3., cr. (3), Register, January, 1994, No. 457, eff. 2-1-94; correction in (2) (b) 3. made under s. 13.93 (2m) (b) 7., Stats., Register, October, 1996, No. 490; r. and recr., Register, September, 2000, No. 537, eff. 10-1-00.

Comm 50.20 Fees. Fees for petitions for variance, material approval, plan examination and approval, and for inspection of buildings, structures, and heating and ventilating shall be submitted as specified in ch. Comm 2. Fees shall be submitted at the time the application for approval is submitted. No plan examinations, approvals or inspections may be made until the fees are received.

History: Cr. Register, December, 1976, No. 252, eff. 1-1-77; am. Register, August, 1985, No. 356, eff. 1-1-86; am. Register, January, 1994, No. 457, eff. 2-1-94; correction made under s. 13.93 (2m) (b) 7., Stats., Register, October, 1996, No. 490.

Subchapter V — First Class City and Certified Municipal Approvals

Comm 50.21 Certified municipalities and counties.

(1) GENERAL. This section establishes the manner under which cities, villages, towns and counties may examine building plans and inspect buildings relative to s. 101.12 (3) (a), (am), (b) and (g), Stats.

(2) CONDITIONS OF PARTICIPATION. (a) Before assuming the responsibilities of examining building plans and providing inspection services, cities, villages, towns and counties shall com-

ply with pars. (b) to (h). While certified, a municipality or county shall comply with pars. (f), (h) and (i).

(b) Notify the department, in writing, at least 30 days prior to the date upon which the municipality or county intends to assume the plan examination and building inspection responsibilities.

(c) Adopt by ordinance or regulation the responsibilities of plan examination and building inspection.

(d) Adopt by ordinance or regulation chs. Comm 50 to 64 in their entirety.

(e) Submit to the department a certified copy of all ordinances or regulations assuming the plan examination and building inspection responsibilities and adopting chs. Comm 50 to 64.

(f) Employ certified commercial building inspectors to perform the plan examination and building inspection functions.

(g) Receive from the department certification to perform plan examinations and building inspections.

(h) Forward to the department any information requested by the department relative to the examination of plans and the inspections of buildings.

(i) Notify the department, in writing, at least 30 days prior to the date upon which the municipality or county intends to relinquish the plan examination and building inspection responsibilities.

(j) Second class cities intending to perform the expanded plan examinations and inspections specified in sub. (5) (b) shall comply with pars. (b) to (i), sub. (7) (b), and all of the following:

1. Employ at least one person who complies with all of the following:

a. Is registered under ch. 443, Stats., as an architect or professional engineer.

b. Is a certified commercial building inspector.

c. Performs or directly supervises the plan examinations specified in sub. (5) (b).

2. Provide a monthly report to the department of all projects completed under this subsection, in an electronic-based format prescribed by the department.

(k) 1. To assume the building inspection responsibility but not the plan examination responsibility for the buildings and structures specified in sub. (5) (c), a municipality or county shall comply with pars. (b) to (i), except the plan examination requirements do not apply, and the department may delegate the inspection authority in a written manner other than a certification.

2. To assume the building inspection responsibility but not the plan examination responsibility for the buildings and structures that exceed the limits specified in sub. (5) (c), a municipality or county shall comply with subd. 1. and all of the following:

a. Obtain authorization for these inspections from the department.

b. Use an inspection process that is based on the inspection process used by the department.

c. Retain inspection records in a manner that is accessible to the department.

d. Forward to the department any information requested by the department relative to the inspection of buildings.

3. A municipality or county may waive its jurisdiction for the inspection of a specific project, in which case the department shall conduct the inspection.

(L) The department may revoke the certification or delegation of authority for any municipality or county where the plan examiners or inspectors do not meet the standards specified by the department, or where other requirements of this section are not met.

Note: For any certified municipality or county, the department may review the competency of plan examiners on a regular basis, and review the correspondence and inspection reports, to determine if uniformity in code application decisions is being maintained, and to determine if the standards specified by the department are being met. Regular meetings and correspondence may be maintained between a certified

municipality or county and the department in order to discuss and resolve any problems.

(3) JURISDICTION. (a) *Departmental.* 1. Nothing in this section shall prevent the department from conducting its own investigations or inspections or issuing orders relative to the administration and enforcement of chs. Comm 50 to 64.

2. The department shall administer and enforce chs. Comm 50 to 64 in any municipality or county which has not assumed the responsibilities for plan examination and building inspections under sub. (2).

(b) *County.* 1. Ordinances enacted by a county under sub. (2) establishing county plan examination and building inspection functions shall apply to all municipalities within that county which have not assumed those functions pursuant to sub. (2).

2. Ordinances enacted by a county under sub. (2) establishing county plan examination and building inspection functions may not prevent or prohibit any municipality within that county from assuming those functions pursuant to sub. (2) at any time.

(4) CERTIFICATION OF INSPECTORS. Inspectors employed by agent municipalities and counties to administer and enforce chs. Comm 50 to 64 under sub. (2) shall be certified by the department in accordance with ch. Comm 5 as certified commercial building inspectors.

(5) PLAN EXAMINATION. (a) *First class cities.* Drawings, specifications and calculations for all the types of buildings and structures specified in s. Comm 50.12 (1), except state-owned buildings and structures, to be constructed within the limits of a first class city shall be submitted to that city, if that city has assumed the responsibilities of plan examination and building inspection in accordance with sub. (2).

(b) *Second class cities performing expanded plan examination.* Drawings, specifications and calculations for all the types of buildings and structures specified in s. Comm 50.12 (1), except state-owned buildings and structures, to be constructed within the limits of a second class city shall be submitted to either the department or to that city, if that city has assumed the responsibilities of examining those plans and inspecting those buildings and structures in accordance with sub. (2) (j). Second class cities performing these expanded examinations are not subject to the plan examination limits specified in par. (c).

Note: Second class cities may also request approval to perform other additional plan review functions under the appointed-agent process in s. Comm 50.22.

(c) *Other municipalities and counties.* 1. Drawings, specifications and calculations for all the types of buildings and structures specified in s. Comm 50.12 (1), except state-owned buildings and structures, to be constructed within the limits of a municipality or county that is not included in pars. (a) and (b) shall be submitted to either the department or to that municipality or county if the municipality or county has assumed the responsibilities of plan examination and building inspection in accordance with sub. (2) and if the plans are for any of the construction specified in this paragraph.

2. A new building or structure containing less than 50,000 cubic feet of total volume.

3. a. An addition to a building or structure where the area of the addition results in the entire building or structure containing less than 50,000 cubic feet of total volume.

b. An addition containing no more than 2,500 square feet of total floor area and no more than one floor level, provided the largest roof span does not exceed 18 feet and the exterior wall height does not exceed 12 feet.

4. An alteration of a space involving less than 100,000 cubic feet of total volume.

(d) *Project waiver.* 1. A certified municipality or county may waive its jurisdiction for the plan review of a specific project or types of projects, or components thereof, in which case plans and specifications shall be submitted to the department for review and approval.

2. The department may waive its jurisdiction for the plan review of a specific project, where agreed to by a certified municipality or county, in which case plans and specifications shall be submitted to the certified municipality or county for review and approval.

(e) *Plan submission procedures.* 1. a. A building permit application shall be included with the plan submitted to the municipality or county having jurisdiction for examination.

b. Plans for a building or structure that exceeds the limits specified in par. (c) which are submitted either to a second class city under par. (b) or to an appointed agent under s. Comm 50.22 shall include the department's plan approval application form specified in s. Comm 50.12 (5), unless a municipally supplied form is submitted that includes the owner's, designer's and supervising professional's statements and signatures which are required on the department's form.

2. At least 2 sets of complete building plans and one copy of specifications shall be submitted to the municipality or county having jurisdiction for examination.

3. a. Building plans submitted to a municipality or county for examination shall include the information specified in subd. 3. b. and s. Comm 50.12 (3) and (4).

b. Plans that are submitted to a municipality under par. (c) by use of the volumes specified in pars. (c) 2. to 4., rather than use of the floor areas listed in par. (c), shall include calculations showing the total volume.

4. After plans and specifications for a project have been submitted to a municipality or county under this section, or to a department office, any subsequent submittal for the purpose of complying with this code shall be submitted to that same office, except as provided in subds. 6. to 9.

5. Except as provided in subds. 6. to 9., plans and specifications for all components of a project, including but not limited to trusses, precast concrete, laminated wood, or heating, ventilating and air conditioning, shall be submitted to the same office.

6. The submitter may choose whether the municipality or county or any of the department's offices is to review plans and specifications for an individual building in a multiple-building complex, even if a previous building in the complex had been reviewed by another office. A subsequent reviewing office may request of the other office complete copies of all pertinent data, including but not limited to petitions, application forms, preliminaries, staff notes and comments. The applicant may be charged a fee to offset the costs of providing these copies. If plans for some of the buildings are submitted to the department and some are submitted to the municipality or county, and then plans for the building components are submitted for all the buildings, the component submitter shall split the submission and submit the plans to the applicable offices.

7. For multiple-tenant or -owner buildings, including but not limited to shopping centers or office buildings, the plans and specifications for the initial tenant or owner in each space, and the alteration plans and specifications for changing a previously approved space may be submitted either to the municipality or county or to a department office, provided the requirements in s. Comm 50.12 (4) (e) are met.

8. Decisions as to whether plans and specifications for building additions may be submitted to offices other than where the previous approvals occurred shall be handled between the municipality or county, department and submitter on a case-by-case basis. These submittals shall comply with s. Comm 50.12 (4) (f).

9. Departmental review of plans and specifications under this subsection does not satisfy any need for municipal review of these plans and specifications for conformance with local requirements adopted under s. Comm 50.06 that are in addition to or more stringent than chs. Comm 50 to 64, 70, and 75 to 79.

(f) *Plan approval.* 1. If the municipality or county having jurisdiction determines that the plans submitted substantially conform to the provisions of chs. Comm 50 to 64 or other ordinances and regulations, an approval shall be issued as follows:

a. The plans shall be stamped "CONDITIONALLY APPROVED", signed and dated by a certified commercial building inspector.

b. One set of the conditionally approved plans, and all calculations and correspondence shall be retained in their original form or as readable microfilm— or electronic—based copies for at least 4 years by the municipality or county, and all other approved plans shall be returned to the submitter or their representative.

c. A notice of conditional approval shall be provided, in writing, to the submitter and the building owner stating all conditions of approval. A copy of the notice shall be provided to the department of health and family services for health care facilities, and to the department of corrections for jails and places of detention.

2. All non-code-complying and other conditions stated in the conditional approval notice shall be corrected or met before or during construction, and before occupancy of the building.

(g) *Denial of plan approval.* If the municipality or county determines that the plans submitted do not substantially conform to the provisions of chs. Comm 50 to 64 or other legal ordinances and regulations, a denial for plan approval shall be issued as follows:

1. The plans shall be stamped "NOT APPROVED", signed and dated by a certified commercial building inspector.

2. One set of the not-approved plans shall be retained by the municipality or county and all other plans shall be returned to the submitter or their representative.

3. A notice of the not-approved plans shall be provided in writing, to the submitter and the building owner stating the reasons for the denial.

(h) *Liability.* A conditional approval of a plan by a municipality or county may not be construed as an assumption of any responsibility on the part of the municipality, the certified commercial building inspector or the department for the design or construction of the building.

(6) **INSPECTION.** Inspections shall be conducted by a certified municipality or county to ascertain whether or not the construction or installation for buildings and structures conforms to the conditionally approved plans, the notice of conditional approval and chs. Comm 50 to 64 as follows:

(a) All inspections, for the purpose of administration and enforcement of chs. Comm 50 to 64, shall be performed by a certified commercial building inspector.

(b) A written report of each inspection shall be prepared. The report shall include the name of the certified commercial building inspector.

(c) A copy of each inspection report shall be furnished to the owner and plan submitter.

(d) A copy of each inspection report shall be permanently maintained in the municipal files or county files.

(e) The inspection report shall indicate all items of non-compliance noted during the inspection.

(f) If non-complying items are not corrected, orders to correct shall be issued in accordance with local ordinances.

Note: Certified municipalities are authorized to perform the inspections specified in s. Comm 50.18.

(7) **FEES.** (a) Municipalities and counties having jurisdiction of plan examination and building inspections may set by ordinance the fees for plan examination and building inspection services.

(b) A second class city that is certified to perform the expanded plan examinations specified in sub. (5) (b) shall submit to the department the fees specified in s. Comm 2.31 (1) (e) or (g).

Note: See A list of the municipalities and counties providing plan examination and building inspections under this section is available from the Safety and Buildings Division at P.O. Box 7162, Madison, WI 53707-7162, or at telephone 608/266-3151 and 608/264-8777 (TTY), or at the Safety and Buildings' web site at www.commerce.state.wi.us.

History: Cr. Register, December, 1976, No. 252, eff. 1-1-77; r. and recr. Register, April, 1985, No. 352, eff. 5-1-85; am. (5) (b) 3., renum. (5) (c) to (f) to be (5) (d) to (g), cr. (5) (c), Register, March, 1991, No. 423, eff. 4-1-91; am. (5) (b) 1, to 3., Register, March, 1995, No. 471, eff. 4-1-95; am. (2) (e), (4), (5) (e) 1. a., (f) 1., (g), (6) (a), (b), Register, October, 1996, No. 490, eff. 11-1-96; am. (1), (2) (i), (5) (f) 1. b., c., (6) (intro.), renum. (2) (f) and (g) to be (2) (h) and (i), (5) (b) to (g) to be (5) (e) to (h), (5) (e) 1. to be (5) (e) 1. a., (7) to be (7) (a), renum. (2) (intro.) and (a) to (e) to be (2) (a) to (f) and am. (2) (a), (b) and (d) as renum., cr. (2) (g), (j) to (L), (5) (b), (d) 2., (e) 1. b., 3. b. and 4. to 9., (7) (b), r. and recr. (5) (c), renum. and am. (5) (d) to be (5) (d) 1., (5) (e) 3. to be (5) (e) 3. a., Register, September, 2000, No. 537, eff. 10-1-00.

Comm 50.22 Appointed agents. (1) **GENERAL.** This section establishes the manner under which cities, villages, towns and counties may examine building plans and inspect buildings as appointed agents for the department under s. 101.02 (5) (b), Stats.

(2) **CONDITIONS OF PARTICIPATION.** (a) Before assuming any of the department's plan examination or building inspection responsibilities that are not listed in s. Comm 50.21 (5), a city, village, town or county shall comply with pars. (b) to (e). While appointed, a municipality or county shall comply with pars. (f) to (i).

(b) Submit a written request to the department, at least 30 days prior to the date upon which the municipality or county desires to assume agent responsibilities for plan examination or building inspection.

(c) Include in the request a description of the desired responsibilities, such as plan examination for buildings that are not within the municipality or county, or plan examination for building additions or alterations that are beyond the limits specified in s. Comm 50.21 (5) (c).

(d) Include in the request a description of the qualifications the municipality or county has for assuming the desired responsibilities.

(e) Receive from the department a written statement prescribing the responsibilities that are to be assumed.

(f) Apply the corresponding requirements in s. Comm 50.21 (5) (d) to (h) and (6).

(g) Collect the plan examination fees that the department would otherwise collect, as specified in s. Comm 2.31, and submit to the department the fees specified in s. Comm 2.31 (1) (f) or (g).

(h) Provide a monthly report to the department of all projects completed under this section, in an electronic-based format prescribed by the department.

(i) Notify the department, in writing, at least 30 days prior to the date upon which the municipality or county intends to relinquish the responsibilities assumed under this section.

(3) **REVOCATION.** The department may revoke the agent appointment of any municipality or county where the plan examiners or inspectors do not meet the standards specified by the department, or where other requirements of this section are not met.

Note: A list of the municipalities and counties providing plan examinations and building inspections under this section is available from the Safety and Buildings Division at P.O. Box 7162, Madison, WI 53707-7162, or at telephone 608/266-3151 and 608/264-8777 (TTY), or at the Safety and Buildings' web site at www.commerce.state.wi.us.

History: Cr. Register, September, 2000, No. 537, eff. 10-1-00.

Subchapter VI — Enforcement, Petition for Variance, Appeals, and Penalties

Comm 50.23 Enforcement. The provisions of this code shall be enforced by the department, or by municipal officials or other local officials who are required by law to enforce the administrative rules of the department.

History: Cr. Register, December, 1976, No. 252, eff. 1-1-77.

Comm 50.24 Appeals. Any person affected by any local order which is in conflict with a rule of the department may petition the department for a hearing on the grounds that the local order is unreasonable and in conflict with the rule of the department. The department shall review and make a determination on an appeal of a local ordinance within 60 business days of receipt of a verified petition submitted with all forms, fees, plans and documents required to complete the review.

Note: Section 101.01 (1) (g), Stats., defines "local order" as any ordinance, order, rule or determination of any common council, board of alders, board of trustees or the village board, of any village or city, or the board of health of any municipality, or an order or direction of any official of such municipality, upon any matter over which the department has jurisdiction.

History: Cr. Register, December, 1976, No. 252, eff. 1-1-77; am. Register, January, 1985, No. 349, eff. 2-1-85.

Comm 50.25 Petition for variance. The department shall consider and may grant a variance to a provision of this code in accordance with ch. Comm 3. The petition for variance shall include, where applicable, a position statement from the fire department having jurisdiction.

Note: Chapter Comm 3 requires the submittal of a petition for variance form (SBD-9890) and a fee, and that an equivalency is established in the petition for variance which meets the intent of the rule being petitioned. Chapter Comm 3 also requires the department to process regular petitions within 30 business days and priority petitions within 10 business days.

Note: The department forms required in this chapter are available from the Safety and Buildings Division at P.O. Box 7162, Madison, WI 53707-7162, or at telephone 608/266-3151 and 608/264-8777 (TTY). Some of the department forms are also available from the Department's web site at [HYPERLINK "http://www.commerce.state.wi.us/SB-Forms.html."](http://www.commerce.state.wi.us/SB-Forms.html) www.commerce.state.wi.us.

History: Cr. Register, December, 1976, No. 252, eff. 1-1-77; am. Register, December, 1978, No. 276, eff. 1-1-79; am. Register, May, 1980, No. 293, eff. 6-1-80; am. Register, October, 1984, No. 346, eff. 11-1-84; cr. (2), Register, Janu-

ary, 1985, No. 349, eff. 2-1-85; r. and recr., Register, September, 2000, No. 537, eff. 10-1-00.

Comm 50.26 Penalties. Penalties for violations of this code shall be assessed in accordance with s. 101.02 (12) and (13) (a), Stats.

Note: Section 101.02 (13) (a), Stats., indicates penalties will be assessed against any employer, employee, owner or other person who fails or refuses to perform any duty lawfully enjoined, within the time prescribed by the department, for which no penalty has been specifically provided, or who fails, neglects or refuses to comply with any lawful order made by the department, or any judgment or decree made by any court in connection with ss. 101.01 to 101.25. For each such violation, failure or refusal, such employee, owner or other person must forfeit and pay into the state treasury a sum not less than \$10 nor more than \$100 for each violation.

Note: Section 101.02 (12), Stats., indicates that every day during which any person, persons, corporation or any officer, agent or employee thereof, fails to observe and comply with an order of the department will constitute a separate and distinct violation of such order.

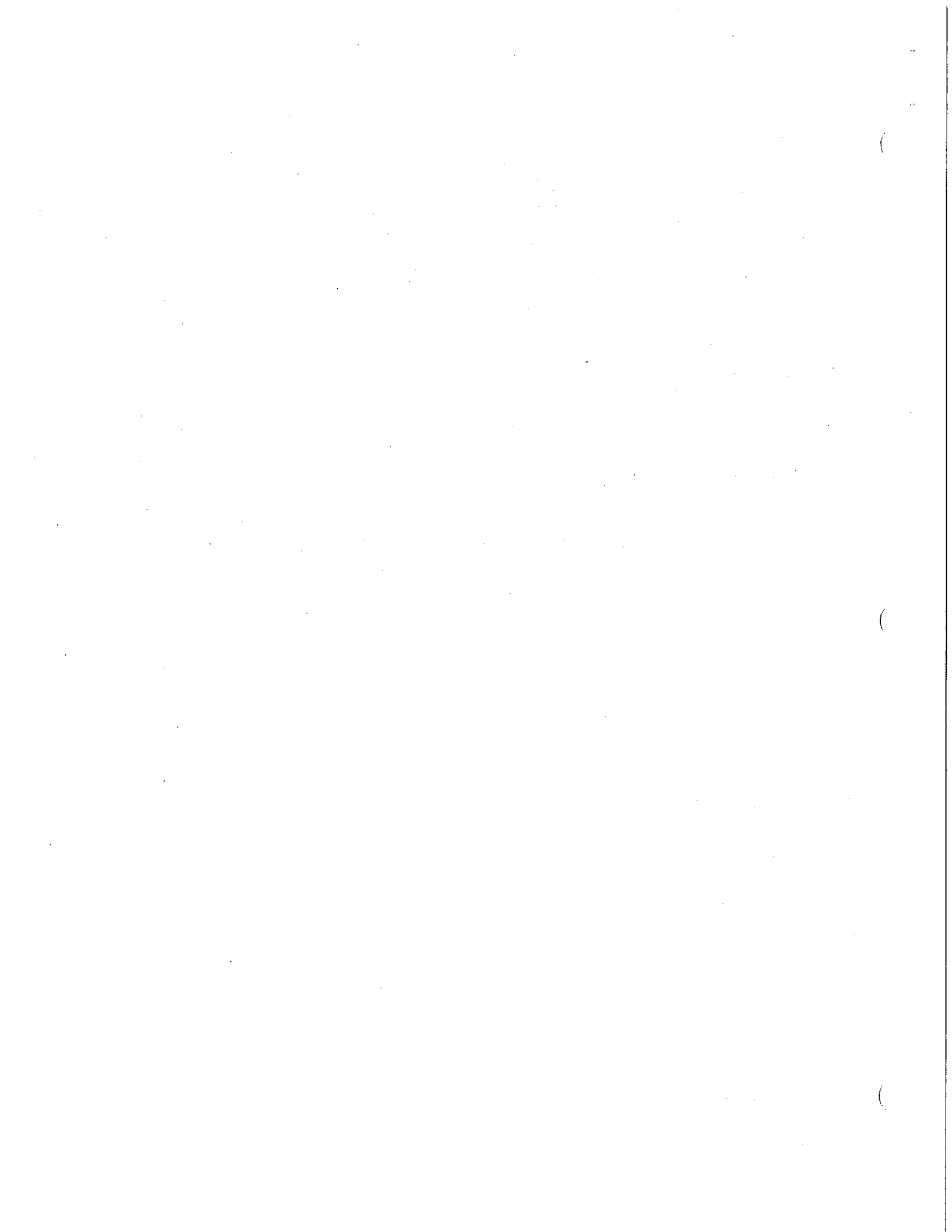
History: Cr. Register, December, 1976, No. 252, eff. 1-1-77; am., Register, September, 2000, No. 537, eff. 10-1-00.

Comm 50.27 Appeals. (1) Any person who owns or occupies a property that is affected by an order of the department may petition the department for a hearing on the reasonableness of the order, as specified in ss. 101.02 (6) (e) to (i), Stats.

(2) Any person affected by a local order that is in conflict with a rule of the department may petition the department for a hearing on the local order, as specified in ss. 101.02 (6) (e) to (i) and (7) (b), Stats.

(3) In addition to any other right provided by law, any interested person may file a written request for a contested case hearing, as specified in s. 227.42, Stats.

History: Cr. Register, September, 2000, No. 537, eff. 10-1-00.



Chapter Comm 51

DEFINITIONS AND STANDARDS

Comm 51.01 Definitions.

Subchapter I — Standards for Classes of Construction

Comm 51.015 Scope.
Comm 51.02 General requirements.
Comm 51.03 Classes of construction standards.

Subchapter II — Fire-Resistive Standards for Materials of Construction

Comm 51.04 Scope.
Comm 51.042 General requirements.
Comm 51.043 Approved rating methods.
Comm 51.045 Typical examples of fire-resistive structural components.
Comm 51.046 Calculation method.
Comm 51.047 Fire-rated door assemblies in fire-rated construction.
Comm 51.048 Fire window and glass block assemblies in fire-rated construction.
Comm 51.0485 Fire dampers, smoke dampers and ceiling dampers.
Comm 51.049 Miscellaneous penetrations in fire-resistive construction.
Comm 51.05 Roof coverings.
Comm 51.06 Foam plastics.
Comm 51.065 Light-transmitting plastics.
Comm 51.07 Interior finishes.
Comm 51.08 Occupancy separations and hazard enclosures.
Comm 51.14 Safety glazing.

Comm 51.15 Standard exit doors.
Comm 51.151 Exit distribution.
Comm 51.152 Egress directions.
Comm 51.16 Stairways and ramps.
Comm 51.161 Handrails.
Comm 51.162 Guardrails.
Comm 51.164 Headroom.
Comm 51.165 Stairway identification.
Comm 51.166 Stairway discharge.
Comm 51.167 Exiting through areas of hazard.
Comm 51.17 Smokeproof stair tower.
Comm 51.18 Interior enclosed stairway.
Comm 51.19 Horizontal exit.
Comm 51.20 Fire escapes.
Comm 51.21 Standpipe and hose systems.
Comm 51.22 Fire extinguishers.
Comm 51.23 Automatic sprinklers.
Comm 51.235 Alternate fire suppression systems.
Comm 51.236 Manual-wet sprinkler system.
Comm 51.24 Fire alarm systems.
Comm 51.245 Smoke detectors.
Comm 51.25 Incorporation of standards by reference.

Note: Chapter Ind 51 was renumbered to be chapter ILHR 51 effective January 1, 1984. Chapter ILHR 51 was renumbered to be chapter Comm 51 under s. 13.93 (2m) (b) 1. and corrections were made under s. 13.93 (2m) (b) 7., Stats., Register, December, 1997, No. 504.

Note: The definitions of words and phrases not defined in this section should be taken from the current edition of Webster's New International Dictionary.

Comm 51.01 Definitions. (1) "Accessory room" means any room or enclosed floor space used for eating, cooking, bathrooms, water closet compartments, laundries, pantries, foyers, hallways and other similar floor spaces. Rooms designated as recreation, study, den, family room, office and other similar floor spaces, in addition to habitable rooms, are not considered accessory rooms.

(1g) "Adult family home" has the meaning given in s. 50.01 (1), Stats.

Note: Under s. 50.01 (1), Stats., an "adult family home" means a private residence to which all of the following apply:

The private residence was licensed under s. 48.62 as a foster home for the adults specified in par. (a) at least 12 months before any of the adults attained 18 years of age.

(1m) AIR CONDITIONING. The process of treating air to control simultaneously its temperature, humidity, cleanliness and distribution to meet the requirements of the conditioned space.

(2) ALLEY. Any legally established public thoroughfare less than 30 feet in width but not less than 10 feet in width whether designated by name or number.

(2m) "Amusement facility" has the meaning given in s. 101.128 (1) (a), Stats.

Note: Section 101.128 (1) (a), Stats., defines amusement facility as any zoo, state or local park, amusement or theme park, state fair park, or county or other local fairgrounds. For the purposes of calculating sanitary fixtures, an amusement facility may also be referred to as an outdoor event.

(2r) "Annular space" means the opening around a penetrating item.

(3) APPROVED. Approval granted by the department under the regulations stated in this code.

(3a) "Approved diversified tests" means fire tests which evaluate materials or construction assemblies representative of actual end use applications.

Note: Approved diversified tests may include, but are not limited to: ASTM E 84—Test for Surface Burning Characteristics of Building Materials; ASTM E 119—Fire Tests of Building Construction and Materials; ASTM D 1929—Standard Test Method for the Ignition Properties of Plastics; FM 4880—Factory Mutual Building Corner Fire Test; and UL 1040—Outline of Investigation of Insulated Wall Construction.

(4) AREA (GROSS). The maximum horizontal projected area within the perimeter of the outside surface of walls or supports of the building or structure. Exterior cantilever open balconies are not included.

(5) AREA (NET). The occupied or usable floor area in a building but not including space occupied by columns, walls, partitions, stairways, mechanical shafts or ducts.

(5a) AREAWAY. Exterior area whose grade is below the grade (at building) and having at least one side consisting of the exterior wall of a building.

(5b) "Atrium" means a floor opening or series of floor openings connecting 3 or more floor levels, but not including a mezzanine or a balcony, that is covered at the top of the series of openings and is used for purposes other than an enclosed stairway; elevator hoistway; or utility shaft used for plumbing, electrical, air conditioning or communication facilities.

(6) ATTIC. The space not used for human occupancy located between the ceiling of uppermost story and the roof.

(6m) "Authorized representative" means any certified municipality or county as specified in s. Comm 50.21, and any appointed agent as specified in s. Comm 50.22.

(7) "Automatic" means a function that occurs without human intervention.

(7a) "Automatic fire sprinkler system", for fire protection purposes, means an integrated system of underground and overhead piping designed in accordance with fire protection engineering standards. The system includes a suitable water supply, such as a gravity tank, fire pump, reservoir or pressure tank or connection beginning at the supply side of an approved gate valve located at or near the property line where the pipe or piping system provides water used exclusively for fire protection and related appurtenances and to standpipes connected to automatic sprinkler systems. The portion of the sprinkler system above ground is a network of specially sized or hydraulically designed piping installed in a building, structure or area, generally overhead, and to which sprinklers are connected in a systematic pattern. The system includes a controlling valve and a device for actuating an alarm when the system is in operation. The system is usually activated by heat from a fire and discharges water over the fire area.

(7b) "Automatic fire suppression system" means a mechanical system designed and equipped to detect a fire, actuate an alarm

and suppress or control a fire using water, water spray, foam, carbon dioxide, halogenated agent or other approved suppression agent.

(8) BALCONY (EXTERIOR). An elevated platform attached to a building and enclosed on one or more sides by railings.

(9) BALCONY (INTERIOR). An open intermediate level or stepped floor. Also see "Stories, Number of."

(10) BASEMENT. A basement floor is that level below the first or ground floor level with its entire floor below exit discharge grade.

(11) BEARING WALL. See "Wall (bearing)."

(11a) "Bed and breakfast establishment" has the meaning given in s. 254.61, Stats.

Note: Section 254.61, Stats., reads: "Bed and breakfast establishment" means any place of lodging that:

(a) Provides 8 or fewer rooms for rent to no more than a total of 20 tourists or transients;

(b) Provides no meals other than breakfast and provides the breakfast only to renters of the place;

(c) Is the owner's personal residence;

(d) Is occupied by the owner at the time of rental;

(e) Was originally built and occupied as a single-family residence, or, prior to use as a place of lodging, was converted to use and occupied as a single-family residence; and

(f) Has had completed, before May 11, 1990, any structural additions to the dimensions of the original structure, including by renovation, except that a structural addition, including a renovation, to the structure may, after May 11, 1990, be made within the dimensions of the original structure.

(12) BUILDING. A structure for support, shelter or enclosure of persons or property.

Note: See Appendix A for further explanatory material.

(13) "Building or structure" means public building or place of employment.

(13m) "Building, public" has the meaning given in s. 101.01 (12), Stats.

Note: Section 101.01 (12), Stats., reads: "Public building" means any structure, including exterior parts of such building, such as a porch, exterior platform or steps providing means of ingress or egress, used in whole or in part as a place of resort, assemblage, lodging, trade, traffic, occupancy, or use by the public or by 3 or more tenants. When used in relation to building codes, "public building" does not include a previously constructed building used as a community-based residential facility as defined in s. 50.01 (1g) which serves 20 or fewer residents who are not related to the operator or administrator or an adult family home, as defined in s. 50.01 (1).

(14) BUTTRESS. A structural projection which is an integral part of a wall, primarily to provide resistance to lateral forces.

(15) CAVITY WALL. See "Wall (cavity)."

(15m) CEILING PROTECTION. The fire protection membrane suspended beneath the floor or ceiling construction which, when included with the construction, develops the fire-resistive rating for the overall assembly.

(16) "Cemetery authority" means any person who owns or operates a cemetery specified in s. 157.065 (1), Stats.

(16a) "Certified commercial building inspector" means a person who holds a credential issued by the department under ch. Comm 5 as a certified commercial building inspector.

(17) CLOSING DEVICE (FIRE DOOR). A closing device is one which will close the door and be adequate to latch or hold, or both, hinged or sliding door in a closed position.

(a) *Automatic.* An automatic closing device is one which functions without human intervention and is actuated as a result of the predetermined temperature rise, rate of rise of temperature, combustion products or smoke density.

(b) *Self-closing.* A self-closing device is one which will maintain the door in a closed position.

(17g) "Cfm" means cubic feet per minute.

(17m) "Code" means chs. Comm 50 to 64.

(17n) "Column" means an upright member in a building's structural framing, having a spacing of 48 inches or greater on center, which is constructed of heavy timber with nominal cross-sectional dimensions of at least 6 inches by 8 inches, precast or load-bearing concrete, masonry, or steel, and which is used primarily to support axial compressive loads.

(18) COMBUSTIBLE CONSTRUCTION. An assembly such as a wall, floor or roof having components of combustible material.

(19) COMBUSTIBLE MATERIAL. All materials not classified as "noncombustible" are considered combustible. This property of a material does not relate to its ability to structurally perform under fire exposure. The degree of combustibility is not defined by standard fire test procedures.

(19a) "Commercial motor vehicle" means all motor vehicles other than passenger vehicles for not more than 9 passengers.

(19b) "Community-based residential facility" or "CBRF" has the meaning given in s. 50.01 (1g), Stats.

Note: Section 50.01 (1g), Stats., reads: "Community-based residential facility" means a place where 5 or more adults who are not related to the operator or administrator and who do not require care above intermediate level nursing care reside and receive care, treatment or services that are above the level of room and board but that include no more than 3 hours of nursing care per week per resident. "Community-based residential facility" does not include any of the following:

(a) A convent or facility owned or operated by members of a religious order exclusively for the reception and care or treatment of members of that order.

(b) A facility or private home that provides care, treatment and services only for victims of domestic abuse, as defined in s. 46.95 (1) (a), and their children.

(c) A shelter facility as defined under s. 16.352 (1) (d).

(d) A place that provides lodging for individuals and in which all of the following conditions are met:

1. Each lodged individual is able to exit the place under emergency conditions without the assistance of another individual.

2. No lodged individual receives from the owner, manager or operator of the place or the owner's, manager's or operator's agent or employee any of the following:

a. Personal care, supervision or treatment, or management, control or supervision of prescription medications.

b. Care or services other than board, information, referral, advocacy or job guidance; location and coordination of social services by an agency that is not affiliated with the owner, manager or operator, for which arrangements were made for an individual before he or she lodged in the place; or, in the case of an emergency, arrangement for the provision of health care or social services by an agency that is not affiliated with the owner, manager or operator.

(e) An adult family home.

(f) A residential care apartment complex.

(g) A residential facility in the village of Union Grove that was authorized to operate without a license under a final judgment entered by a court before January 1, 1982, and that continues to comply with the judgment notwithstanding the expiration of the judgment.

(19m) "Composting toilet system" means a method that collects, stores and converts by bacterial digestion nonliquid-carried human wastes or organic kitchen wastes, or both, into humus.

(20) CONCRETE. See "Types of Concrete," s. Comm 51.045 (1) (a).

(21) CONSTRUCTION. Includes all labor and materials used in the framing or assembling of component parts in the erection, installation, enlargement, alteration, repair, moving, conversion, razing, demolition or removal of any appliance, device, building, structure or equipment.

(22) CORRIDOR. An enclosed passageway in a building for public ingress and egress to and from dwelling units, rooms or other areas and leading to a lobby, foyer or exit discharge.

(22a) CORRIDOR (REQUIRED EXIT). A fire-rated enclosure beginning at the end point of maximum allowable exit distance and continuing to the exit discharge door.

Note: See line 19 of Table 51.03-A.

(23) COURT. A court is an open, exterior space providing required natural light or ventilation for the building or providing a pathway for public egress from a building exit to a public thoroughfare.

(24) COURT (INNER). An inner court is a court surrounded on all sides by walls.

(25) COURT (INNER LOT LINE). An inner lot line court is a court bounded on 3 sides by walls and on the remaining side by a lot line or property line.

(26) COURT (OUTER). An outer court is a court bounded on 3 sides with walls and on the remaining side by a street, alley or other open space not less than 15 feet wide.

(27) COURT (OUTER LOT LINE). A court with one side on a lot line or property line and opening to a street or open space not less than 15 feet wide.

(28) CURTAIN WALL. See "Wall (curtain)."

(29) DEPARTMENT. Means the department of commerce.

(29a) "Direct vent sealed combustion chamber appliance" means a gas-fired heating appliance which is constructed and

installed so that all air for combustion is brought directly from the outside atmosphere to inside the combustion chamber and all flue gases are discharged directly to the outside atmosphere and that is capable of operating only when the integrity of the sealed combustion chamber is maintained.

(29m) "Damper (ceiling)" means a device to limit radiant heat transmission through an air outlet or inlet opening in the ceiling membrane of a floor/roof-ceiling assembly having an assembly fire resistance rating of not less than 1-hour.

(29n) "Damper (fire)" means a device, installed in an air distribution system, designed to close automatically upon detection of heat, to interrupt migratory airflow, and to restrict the passage of flame. A combination fire and smoke damper meets the requirements of both.

(29o) "Damper (smoke)" means a device installed in an air distribution system to control the movement of smoke.

(30) DIVISION WALL. See "Wall (division)."

(31) DUCT. Any pipe, flue, or tunnel used to convey air, gases and entrained materials. An underground duct is any part of a duct that is below the surface of the ground.

(32) DUCT FURNACE. See "Furnace (duct)."

(33) ELEVATOR. See ch. Comm 18.

(34) EQUIPMENT. Self-contained systems and apparatus attached to or built into the building and used for mechanical or electrical processing, comfort, safety, sanitation, communication or transportation within a building.

(35) EXHAUST VENTILATING SYSTEM. See "Ventilating System (exhaust)."

(36) EXISTING. A building, structure, or equipment completed or in the course of construction or use or occupied prior to the effective date of applicable rules of this code.

(36a) "Exit" means that portion of a means of egress which is separated from all other spaces of the building or structure by construction providing a protected way of travel to the exit discharge.

(36b) "Exit access" means that portion of a means of egress which leads to an entrance to an exit.

(36c) "Exit access corridor" means an aisle or passageway in a building that forms that portion of the means of egress which leads to an exit.

(36d) "Exit access door" means any door that leads to the exit access.

(37) EXIT COURT. See "Court (exit)."

(37a) "Exit discharge" means that portion of a means of egress between the termination of an exit and a street, alley, court or a public way.

(38) EXIT DISCHARGE GRADE. See "Grade (exit discharge)."

(38a) "Exit door" means a door that leads from that portion of a means of egress known as the exit access to the outside of a building or to a required exit, such as a stairway, smokeproof tower, ramp or horizontal exit.

(38b) "Exit passageway" means a horizontal means of exit travel that is protected from a fire in a manner similar to an enclosed interior exit stair.

(39) EXIT (VERTICAL). See "Vertical Exit."

(40) EXTERIOR BALCONY. See "Balcony (exterior)."

(41) EXTERIOR WALL. See "Wall (exterior)."

(41c) "F-rating" means the time period in hours that a through-penetration fire-stop system will limit the spread of flame through the penetrated assembly, including the penetrating elements, when tested in accordance with ASTM E814.

(41g) "Facility where the public congregates" has the meaning given in s. 101.128 (1) (b), Stats.

Note: Section 101.128 (1) (b), Stats., defines "facility where the public congregates" as any of the following that has a capacity or a seating capacity of 500 or more persons:

1. An amusement facility.
2. A convention or trade hall or center.
3. A specialty event center.
4. A sports or entertainment arena, center, or building.
5. A stadium.
6. An airport, bus terminal, train station or other transportation center.

(41m) FACTORY. A factory is any premises wherein labor is used in manufacturing, making or altering or adapting articles for the purpose of trade or gain.

(42) FAMILY. Means 2 or more individuals who are related to each other by blood, marriage, adoption or legal guardianship. For purposes of this code a group of not more than 4 persons not necessarily related by blood or marriage, living together in a single living unit will be considered equivalent to a single family.

Note: See Appendix A for further explanatory material.

(42a) FARM OPERATION. The farm operation is the planting and cultivating of the soil and growing of farm products substantially all of which have been planted or produced on the farm premises.

Note: The farm operation, according to s. 102.04 (3), Stats., includes: the management, conserving, improving and maintaining of the premises, tools, equipment, improvements and the exchange of labor or services with other farmers; the processing, drying, packing, packaging, freezing, grading, storing, delivery to storage, carrying to market or to a carrier for transportation to market and distributing directly to the consumer; the clearing of such premises and the salvaging of timber and the management and use of wood lots thereon but does not include logging, lumbering and wood-cutting operations unless the operations are conducted as an accessory to other farm operations.

(42b) FARM PREMISES. "Farm premises" means areas used for the operations set forth in s. 102.04 (3), Stats., but does not include other areas, greenhouses or other similar structures unless used principally for the production of food and farm plants.

(42c) FARM PRODUCTS. Farm products are defined as agricultural, horticultural and arboricultural crops. Animals considered within the definition of agricultural include livestock, bees, poultry, fur-bearing animals, and wildlife or aquatic life.

(42d) FARMING. Farming means the operation of a farm premises owned or rented by the operator.

(43) FIRE DOOR. A door so constructed as to give protection against the passage of fire.

(44) FIRE DOOR ASSEMBLY. The assembly of fire door and its accessories, including all hardware, frames, closing devices and their anchors, so constructed as to give protection against the passage of fire.

(45) FIRE DOOR CLOSING DEVICE. See "Closing Device (fire door)."

(46) FIRE RESISTANCE AND FIRE-RESISTIVE MATERIAL. Having the property to withstand fire or give protection from it. As applied to elements of building, it is characterized by the ability to confine a fire or to continue to perform a given structural function, or both.

(47) FIRE-RESISTIVE CLASSIFICATION. Fire-resistive classification is the time in hours during which a material or assembly continues to exhibit fire resistance under specific conditions of tests and performance.

(48) FIRE-RESISTIVE PROTECTION. An insulating material applied directly, attached to, or suspended from a structural assembly, to maintain the structural integrity of a member or system for the specified time rating.

(49) FIRE-RESISTIVE PROTECTION, DIRECTLY APPLIED. A coating material applied directly to the structural element for the purpose of fire protection.

(50) FIRE-RESISTIVE RATING. Refer to fire-resistive classification.

(51) FIRE-RETARDANT ROOF COVERINGS. Roof coverings shall be classified on the basis of protection provided against fire originating outside the building or structure on which they have been installed.

(a) Class A roof coverings are those which are effective against severe fire exposures (meeting the 3 methods for fire tests of class A roof coverings [ASTM Standard E-108]) and possess no flying brand hazard.

(b) Class B roof coverings are those which are effective against moderate fire exposures (meeting the 3 methods for fire tests of class B roof coverings [ASTM Standard E-108]) and possess no flying brand hazard.

(c) Class C roof coverings are those which are effective against light fire exposures (meeting the 3 methods for fire tests of class

C roof coverings [ASTM Standard E-108]) and possess no flying brand hazard.

(52) FIRE RETARDANT—TREATED WOOD. Fire-retardant wood includes lumber or plywood that has been treated with a fire-retardant chemical to provide classifications (flame-spread [FSC] and fuel contributed [FCC]) of 25 or less by ASTM method E-84, shows no progressive combustion during 30 minutes of fire exposure by this method, and is so labeled. Fire-retardant wood for decorative and interior finish purposes provides reduced flame-spread classification (FSC) by ASTM method E-84 as specified by the code for materials used in the particular applications.

(52m) "Fire-stop system, approved" means a fire-stop product or device that is tested and listed by an approved testing laboratory under ASTM E814 regarding the ability, the F-rating, to retard the passage of flame for a specific time period.

Note: See sub. (41c) for the definition of F-rating.

(53) FIRE WINDOW ASSEMBLY. A fire window includes glass, frame, hardware and anchors constructed and glazed to give protection against the passage of flame.

(54) FIRST FLOOR. The first floor is the primary floor used in determining the number of stories of a building.

(55) FLAME-SPREAD CLASSIFICATION. Flame-spread classification (FSC) is a comparative rating of the measure of flame-spread on a surface of a material or assembly as determined under conditions of tests and performance as specified in ASTM E-84.

(56) FLAME-SPREAD RATING. Refer to flame-spread classification.

(56m) FLOOR. The bottom or lower part of an enclosed space including any portions raised or depressed by not more than 3 feet from the designated principal level where the raised or depressed portion is treated architecturally as a part of the same principal level.

(57) FLOOR AREA. See "Area (net)."

(57a) FLOOR LEVEL. The upper surface of a floor treated architecturally as the designated principal floor at a given elevation.

(57b) "Foam plastic" means a manufactured organic material used as a building material, insulation or sound-absorbing material.

(58) FOYER. An enclosed space and passageway into which aisles, corridors, stairways, or elevators may exit and from which the public has access to exits.

(58a) "Freestanding freezer and cooler" means equipment with an aggregate floor area of less than 400 square feet used to provide a controlled environment at 50°F. or less for storing, displaying or merchandising of products. The freezers and coolers are installed in a building or structure for weather protection and do not rely upon the building or structure for lateral or vertical support, except for the floor load.

Note: Freezers and coolers which do not meet this definition are considered refrigerated facilities. See s. Comm 51.06 (7) (a) for additional requirements.

(58b) "Freezer warehouse" means a building or structure designed and operated at a temperature of 32°F. or below and adapted to the reception and storage of goods, products and merchandise.

(59) FRONT YARD. See "Yard (front)."

(61) FURNACE. A completely self-contained direct-fired, automatically controlled, vented appliance for heating air by transfer of heat of combustion through metal to the air and designed to supply heated air through ducts to spaces remote from the appliance location.

(62) FURNACE (DUCT). A suspended direct-fired heating appliance normally installed in air ducts. Air circulation is provided by a blower not furnished as part of the appliance.

(63) GRADE (AT BUILDING). Elevation of surface of paved or unpaved ground adjacent to wall of a building.

(64) "Grade, exit discharge" means the elevation of the finished exterior surface of paved or unpaved ground directly below any exit discharge doorsill.

(65) GRAVITY EXHAUST VENTILATION. See "Ventilation (gravity exhaust)."

(66) GROSS AREA. See "Area (gross)."

(67) GROUND FLOOR. A ground floor is that level of a building on a sloping or multilevel site which has its floor line at or not more than 3 feet above exit discharge grade for at least one-half of the required exit discharges.

(67a) HABITABLE ROOM. Any room or enclosed floor space arranged for living and/or sleeping purposes.

Note: See Appendix A for further explanatory material.

(68) HAZARDOUS PIPING. See "Piping (hazardous)."

(68a) "Health care facility" means both hospital or nursing home.

(69) HEATING SYSTEM. Any combination of building construction, machinery, devices or equipment, so proportioned, arranged, installed, operated, and maintained as to produce and deliver in place the required amount and character of heating service.

(70) HEIGHT (BUILDING). Height of a building is measured from the average of the exit discharge grade elevation of all required first story exits to the top of a level roof or to a point $1/2$ of the distance between the intersection of the exterior wall surface (extended) with the roof surface, and the highest part of the roof but not to include penthouses.

Note: For exceptions to penthouses see definition "Stories, Number of."

(71) HOLLOW BONDED WALL. See "Wall (hollow bonded)."

(71k) "Home occupation" means any business, profession, trade or employment conducted in a person's dwelling which may involve that person's immediate family or household and a maximum of one other unrelated person, but does not include a business involving:

(a) Explosives, fireworks or repair of motor vehicles; or

(b) More than 25% of the habitable floor area of the dwelling.

(71m) "Hospital" means any building, structure, institution or place used for the maintenance and operation of facilities for the diagnosis, treatment of and medical or surgical care for 3 or more nonrelated individuals hereinafter designated patients, suffering from illness, disease, injury or disability, whether physical or mental, and including pregnancy and regularly making available at least clinical laboratory services, and diagnostic x-ray services and treatment facilities for surgery, or obstetrical care, or other definitive medical treatment.

(71n) "Household" means those persons who live together in the same dwelling and treat the dwelling as their permanent home or residence.

(71p) "Incinerating toilet" means a self-contained device for the treatment of nonliquid carried wastes that deposits the wastes directly into a combustion chamber, reduces the solid portion to ash and evaporates the liquid portion.

(71t) "Independent inspection agency" means any person, firm, association, partnership or corporation, other than a municipal corporation that performs certified inspections under this code.

(72) INNER COURT. See "Court (inner)."

(73) INNER LOT LINE COURT. See "Court (inner lot line)."

(74) INTAKE (OUTSIDE AIR). See "Outside Air Intake."

(75) INTERIOR BALCONY. See "Balcony (interior)."

(75a) "Interior finish" means the exposed interior surfaces of buildings, including, but not limited to fixed or movable walls and partitions, columns, ceilings, and floors.

(a) "Class A interior finish" includes any material classified at 25 or less on the flame spread test scale and 450 or less on the smoke test scale in accordance with ASTM E 84.

(b) "Class B interior finish" includes any material classified at more than 25 but not more than 75 on the flame spread test scale and 450 or less on the smoke test scale in accordance with ASTM E 84.

(c) "Class C interior finish" includes any material classified at more than 75 but not more than 200 on the flame spread test scale and 450 or less on the smoke test scale in accordance with ASTM E 84.

(d) "Class I interior floor finish" includes any material with a minimum critical radiant flux of 0.45 watts per square centimeter as determined in accordance with ASTM E 648.

(e) "Class II interior floor finish" includes any material with a minimum critical radiant flux of 0.22 watts per square centimeter as determined in accordance with ASTM E 648.

(76) JACKETED STOVE. See "Stove (jacketed)."

(76a) "Landowner" means any person holding fee title, an easement or other interest in property which allows the person to undertake land disturbing construction activity on the property.

(76b) LIVING UNIT. Any enclosed floor space consisting of one or more habitable rooms (with or without accessory rooms) used by a person or family.

(77) LOBBY. An enclosed space into which aisles, corridors, stairways, elevators or foyer may exit and provides access to exits.

(78) LOT LINE. A legally established line dividing one lot, plot of land or parcel of land from an adjoining lot or plot of land or parcel of land.

(79) MAJOR APPARATUS. Central air-handling equipment supplying more than one occupancy or rooms and heat-producing equipment generating heat for the heating and ventilating system.

(79m) MASONRY. A construction composed of separate units such as brick, block, hollow tile, stone or approved similar units or a combination thereof, laid up or built unit by unit and bonded by approved manner.

(79r) "Mausoleum" means a building, structure or part of a building or structure that is used or intended to be used for the burial of human remains.

(80) "Mausoleum space" means a niche, crypt or specific place in a mausoleum that contains or is intended to contain human remains.

(80a) "Means of egress" means a continuous and unobstructed way of exit travel from any point in a building or structure to a street, alley, court or a public way. A means of egress consists of the exit access, the exit and the exit discharge. A means of egress includes the vertical and horizontal ways of travel and includes intervening room space, doorways, hallways, corridors, passageways, balconies, ramps, stairs, enclosures, lobbies, horizontal exits and courts.

(81) MECHANICAL VENTILATION. See "Ventilation (mechanical)."

(81m) "Membrane penetration" means an opening made through one side of an assembly that is a building element as listed in Table 51.03.

Note: An example of a membrane penetration is a recessed outlet box penetrating the gypsum wallboard (the gypsum wallboard is the "membrane") on one side of stud wall construction.

(82) "Mezzanine" means an intermediate floor level, either open or enclosed.

Note: See also sub. (122), "stories, number of" and s. Comm 51.02 (14) pertaining to the determination of the number of stories.

(82a) "Mini-storage building" means an unoccupied compartmentalized building used for storage.

(83) NET AREA. See "Area (net)."

(84) NONBEARING WALL. Refer to "Wall (exterior)" or "Partition."

(85) NONCOMBUSTIBLE CONSTRUCTION. An assembly such as a wall, floor or roof having components of noncombustible material.

(86) NONCOMBUSTIBLE MATERIAL. A noncombustible material is one which, in the form in which it is used, meets one of the requirements par. (a) or (b). Materials used adjacent to or in contact with heat-producing appliances, warm air ducts, plenums and chimneys shall be classified as noncombustible only on the basis of requirement par. (a). Noncombustible does not apply to the flame-spread characteristics of interior finish or trim materials. No material shall be classed as noncombustible building construction material which is subject to increase in combustibility or flame-spread classification (FSC) beyond the limits herein estab-

lished through the effects of age, moisture or other atmospheric conditions.

Note: The federal trade commission does not consider ASTM E-84 as an accurate indicator of the performance of cellular plastics used in building construction under actual fire conditions, and that it is only valid as a measurement of the performance of such materials under specific, controlled test conditions. The 25 flame-spread rating is not intended to reflect hazards presented by such products under actual fire conditions. The federal trade commission considers that under actual fire conditions, such products, if allowed to remain exposed or unprotected, will under some circumstances produce rapid flame spread, quick flashover, toxic or flammable gases, dense smoke and intense and immediate heat and may present a serious fire hazard.

(a) Materials which pass the test procedure of ASTM E-136 for defining noncombustibility of elementary materials when exposed to a furnace temperature of 1,382° F. for a minimum period of 5 minutes, and do not cause a temperature rise of the surface or interior thermocouples in excess of 54° F. above the furnace air temperature at the beginning of the test and which do not flame after an exposure of 30 seconds.

(b) Materials having a structural base of noncombustible material as defined in par. (a), with a surfacing not more than 1/8 inch thick which has a flame-spread classification (FSC) not greater than 50 when tested in accordance with ASTM E-84.

(86a) "Nursing home" means any building, structure, institution or place which provides 24-hour services including board and room to 3 or more unrelated residents who because of their mental or physical condition require nursing care or personal care in excess of 7 hours a week. The term "nursing home" wherever used in chs. Comm 50-64, includes nursing and convalescent homes, skilled nursing facilities, infirmaries in homes for the aged, and intermediate care facilities of 15 beds or more.

(87) OCCUPANCY OR USE. The purpose for which a building, structure, equipment, materials, or premises, or part thereof, is used or intended to be used as regulated in this code.

(88) OCCUPIED. Refers to any room or enclosure used by one or more persons for other than incidental maintenance.

(89) OPEN SPACES. Front (setback), rear and side yards, exit courts, outer courts, and outer lot line courts on the same property with a building as regulated by this code.

(89g) "Outdoor event" means an event held at a location generally without a permanent structure and may include organized sports games, home tours, auctions, picnics, concerts, art shows, fairs, or any similar, infrequent, short-term event.

(90) OUTDOOR OPENINGS. May be doors, windows or skylights located in outside walls or roof and can be opened to provide natural ventilation to the occupied space.

(90g) "Outdoor toilet" means either a permanently constructed toilet with a disposal cavity, or a portable toilet provided where either a public sewer is unavailable or where additional toilet fixtures are temporarily needed to meet the required number for an outdoor event.

Note: A privy may also be referred to as an outdoor toilet.

(91) OUTER COURT. See "Court (outer)."

(92) OUTER LOT LINE COURT. See "Court (outer lot line)."

(93) OUTLET (SUPPLY OPENING). An opening, the sole purpose of which is to deliver air into any space to provide heating, ventilating or air conditioning.

(93a) "Outpatient surgical facility" means a facility devoted to the performance of surgical procedures utilizing inhalation anesthetics without anticipation of the overnight stay of patients.

(94) OUTSIDE AIR. Air that is taken from outside the building and is free from contamination of any kind in proportions detrimental to the health or comfort of the persons exposed to it.

(95) OUTSIDE AIR INTAKE. Includes the ducts and outdoor openings through which outside air is admitted to a ventilating, air conditioning or heating system.

(96) PANEL WALL. See "Wall (panel)."

(97) PARTITION. A partition is an interior nonbearing vertical element serving to enclose or divide an area, room or space. Portable or demountable partitions requiring tools for installation or removal are considered partitions not furniture.

(98) PARTY WALL. See "Wall (party)."

(99) "Penthouse" means an enclosed or partially enclosed structure extending above a roof of a building or structure and enclosing a stairway, tank, elevator, machinery, mechanical equipment or other apparatus and not used for human occupancy.

(100) PIER. An isolated column of masonry or concrete. A section of bearing wall not bonded on the sides into adjoining masonry shall be considered to be a pier when its horizontal dimension measured at right angles to the thickness does not exceed 4 times the thickness.

(101) PILASTER. A projection of masonry for the purpose of bearing concentrated loads, or to compensate for reduction of wall section by chases, openings or recesses, or for the purpose of stiffening the wall against lateral forces. (See also "Buttress.")

(102) "Piping, hazardous" means any service piping conveying flammable or toxic gases or liquids.

(102a) "Place of abode" means a residential building or part of a residential building used as follows:

(a) Occupied as a residence of 3 or more families living independently or occupied by 2 such families and used also for business purposes; or

(b) Occupied for sleeping or lodging purposes by 3 or more persons not members of the same family.

Note: Examples of places of abode include but are not limited to apartment buildings, garden apartments, row houses, town houses, condominiums, hotels, motels, rooming houses, dormitories, convents, monasteries, homes for the aged and certain community-based residential facilities.

(102b) PLACE OF EMPLOYMENT. The term "place of employment" includes every place, whether indoors or out or underground and the premises appurtenant thereto where either temporarily or permanently any industry, trade or business is carried on, or where any process or operation, directly or indirectly related to any industry, trade or business, is carried on, and where any person is, directly or indirectly, employed by another for direct or indirect gain or profit, but does not include any place where persons are employed in a) private domestic service which does not involve the use of mechanical power or b) farming.

(103) PORCH. An unenclosed exterior structure at or near grade attached or adjacent to the exterior wall of any building, and having a roof and floor. (See also "Terrace" and "Balcony.")

(103d) "Portable restroom" means a self-contained portable unit that includes fixtures, incorporating holding tank facilities, designed to receive human excrement.

(103g) "Privy" means an enclosed nonportable toilet into which nonwater-carried human wastes are deposited to a subsurface storage chamber.

Note: Section Comm 83.02 (42) defines a privy as a structure, not connected to a plumbing system, which is used by persons for the deposition of human body wastes.

(104) "Property line" means the following:

(a) A legally established line dividing one lot, plot of land or parcel of land from an adjoining lot or plot of land or parcel of land; or

(b) A permanent easement recorded with the county register of deeds, on file with the department, on adjoining property providing control over the property eased.

(104m) "Public mausoleum" means a mausoleum that holds or is intended to hold the remains of more than 10 humans or a mausoleum in which at least one mausoleum space is offered for sale to the general public.

(105) PUBLIC THOROUGHFARE. Any legally established street or alley as defined herein.

(105a) REMODELING. To remodel or alter, or both, means to change any building or structure which affects the structural strength, fire hazard, internal circulation, or exits of the existing building or structure. This definition does not apply to maintenance, reroofing, or alterations to the heating and ventilating or electrical systems.

(105e) "Recyclable material" means solid waste material prohibited for land disposal and incineration, that is separated,

temporarily stored and collected. These materials include, but are not limited to, aluminum and glass containers, corrugated paper or container board, magazines, newspapers, office paper, foam polystyrene packaging, and plastic or steel containers.

(106) REQUIRED. A term for mandatory use under the provisions of this code.

(106a) REQUIRED EXIT CORRIDOR. See "Corridor (Required Exit)."

(107) RESTRAINED SUPPORT. A flexural member where the supports or the adjacent construction, or both, provides complete or partial restraint against rotation of the ends of the member or partial restraint against horizontal displacement, or both, when subject to a gravity load or temperature change, or both.

(108) RETAINING WALL. See "Wall (retaining)."

(109) RETURN (OR EXHAUST OPENING). Any opening, the sole purpose of which is to remove air from any space being heated, ventilated or air conditioned.

(110) ROADWAY. That portion of a public thoroughfare devoted to vehicular traffic, or that part included between curbs.

(111) ROOF. The structural cover of a building with a slope range bearing from horizontal to a maximum of 60° to the horizontal.

(112) ROOF COVERING. Refers to the covering applied over the roof construction for the purpose of weather or fire resistance.

(113) ROOF COVERINGS (FIRE-RETARDANT). See "Fire-Retardant Roof Coverings."

(114) ROOM. A space within a building completely enclosed with walls, partitions, floor and ceiling, except for openings for light, ventilation, ingress and egress.

(114a) "Rowhouse" means a place of abode not more than 3 stories in height, arranged to accommodate 3 or more attached, side by side or back to back living units.

(114m) "Second class city" has the meaning given in s. 62.05 (1) (b), Stats.

Note: Section 62.05 (1) (b), Stats., reads: Cities of 39,000 and less than 150,000 population shall constitute 2nd class cities.

(115) "Setback" means the distance between the property line or public thoroughfare, and the nearest part of the building, as measured perpendicular to the bisector of the angle formed by the intersection or projected intersection of the building face with the property line or another building face.

Note: See Appendix A for further explanatory material.

(116) SHAFT. A vertical opening in a building extending through one or more stories and/or roof, other than an inner court.

(117) SHALL. A term for mandatory use under the provisions of this code.

(117m) "Shelter facility" has the meaning given in s. 16.352 (1) (d), Stats.

Note: Section 16.352 (1) (d), Stats., reads: "Shelter facility means a temporary place of lodging for homeless individuals or families."

(118) SIGNS. A structure that is intended, designed, or used for advertising, display, identification, announcements, or related purposes; this includes signs, screens, billboards, and other advertising devices of any type.

(119) SIMPLE SUPPORT. A flexural member where the supports or the adjacent construction, or both, allows free rotation of the ends of the member and horizontal displacement when subject to a gravity load or a temperature change, or both.

(119a) "Sleeping area" means the area of residential buildings in which bedrooms or sleeping rooms are located. Bedrooms or sleeping rooms separated by other use areas such as kitchens or living rooms, but not bathrooms, are considered as separate sleeping areas. Each individual room or suite of rooms in hotels, motels, dormitories or congregate living facilities is considered a separate sleeping area.

(119b) "Smoke detector" means a device which detects particles or products of combustion other than heat.

(119e) "Smokeless propellant" means a solid propellant used in small arms ammunition, cannons, rockets or propellant-actuated devices that emits a minimal amount of smoke when ignited.

(119m) "Solid-fuel equipment" means equipment burning solid rather than gas or liquid fuel.

Note: Typical solid fuels are coal and wood.

(120) "Space heater" means a fuel-fired vented, self-contained free-standing or wall recessed heating appliance.

(120a) "Spandrel" means that portion of wall filling the space between the top of a window in one story and the sill of the window in the story above.

(120am) "Specialty event center" has the meaning given in s. 101.128 (1) (g), Stats.

Note: Section 101.128 (1) (g), Stats., defines specialty event center as an open arena used for rallies, concerts, exhibits, or other assemblies with no permanent structure for such assembly. Also refer to sub. (89g) for definition of an outdoor event.

(120b) "Step" means one riser and one tread.

(121) STORIES, NUMBER OF. The number of stories of a multi-story building includes all stories except the basement, ground floor, attic or interior balcony and mezzanine floor. (Also see s. Comm 51.02 (14).)

Note: See Appendix A for further explanatory material.

(122) STORY. The space in a building between the surfaces of any floor and the floor next above or below, or roof next above, or any space not defined as basement, ground floor, mezzanine, balcony, penthouse or attic. (Also see "Stories, Number of.")

(124) "Street" means any legally established public thoroughfare or all-weather hard surface area 30 feet or more in width whether designated or not by name or number such as avenue, boulevard, circle, court, drive, lane, place, road or way. Streets must extend at least 50% of the length of the side of the building and must be accessible to fire fighting equipment.

(125) STRUCTURE. A structure is an assembly of materials forming a construction for occupancy or use meeting the definition of place of employment or public building.

Note: Structures include, among others, buildings, stadiums, tents, reviewing stands, observation towers, radio and television towers, water tanks, piers, wharves, shelters, canopies, and display signs.

(125m) "Stud" means an upright member of a framing wall, having a spacing of less than 48 inches on center, and which is primarily intended to have sheathing fastened to it.

(126) SUPPORT (RESTRAINED). See "Restrained Support."

(127) SUPPORT (SIMPLE). See "Simple Support."

(128) TEMPERED AIR. Air transferred from heated area of building.

(129) TEMPERED OUTSIDE AIR. Outside air heated before distribution.

(130) TERRACE. An unenclosed exterior structure at or near grade having a paved, floored, or planted platform area adjacent to an entrance or to the exterior walls for a building or structure and having no roof.

(130d) "Through penetration" means an opening that passes through an entire assembly that is a building element as listed in Table 51.03.

(130g) "Toilet room" means a room in a permanent structure solely designated for sanitary fixtures which ensures privacy of their use. A toilet room may include a water closet, urinal and a lavatory.

(130m) "Townhouse" means an apartment building where each living unit is served by an individual exterior exit within 3 feet of the exit discharge grade.

(131) TREATED WOOD (FIRE-RETARDANT). See "Fire Retardant-Treated Wood."

(132) UNIT HEATER (HIGH STATIC PRESSURE TYPE). A direct-fired suspended or floor standing, self-contained, automatically controlled and vented, heating appliance having an integral means for circulation of air against 0.2 inch or greater static pressure.

(133) UNIT HEATER (LOW STATIC TYPE). A direct-fired suspended, self-contained automatically controlled, vented heating appliance, having integral means for circulation of air by means of a propeller fan or fans.

(134) VENEERED WALL. See "Wall (veneered)."

(135) VENTILATING SYSTEM (EXHAUST). Any combination of building construction, machinery, devices or equipment, designed

and operated to remove harmful gases, dusts, fumes or vitiated air, from the breathing zone of employees and frequenters.

(136) VENTILATION. The process of supplying or removing air by natural or mechanical means, to or from any space.

(137) VENTILATION (GRAVITY EXHAUST). A process of removing air by natural means, the effectiveness depending on atmospheric condition, such as difference in relative density, difference in temperature or wind motion.

(139) VERTICAL EXIT. A means of egress used for ascension or descension between 2 or more floors, or other levels, and shall include approved exterior stairways, automatic (moving) stairways, fire escapes, ramps, stairways, and smokeproof stair towers.

(139a) VOLUME (TOTAL). The "total volume" (cube or cubage) of a building is the actual cubic space enclosed within the outer surfaces of the outside or enclosing walls and contained between the outer surfaces of the roof and the underside of the lowest floor. The volume of structures without enclosing walls (canopies, roofed shelters and similar structures) will be computed by projecting imaginary vertical planes as the enclosing walls at the outer surface of the exterior supports or columns. For cantilevered structures with interior supports, the imaginary vertical planes will be projected at the farthest roof projection or overhang.

Note: The definition of total volume requires the cube of dormers, penthouses, vaults, pits, enclosed porches and other enclosed appendages to be included as a part of the cube of the building. It does not include the cube of courts or light shafts, open at the top, or the cube of outside steps, cornices, parapets, or open porches or loggias.

(140) WALL. A structural element which is vertical or within 30° of vertical, serving to enclose space, form a division, or support superimposed weight.

(141) WALL (BEARING). Any wall which supports a load in addition to its own weight.

(142) WALL (CAVITY). A wall built of masonry units or of plain concrete, or a combination of these materials, so arranged to provide an air space within the wall, and in which the facing and backing (inner and outer parts) of the wall are tied together with metal ties.

(143) WALL (CURTAIN). An exterior nonbearing wall.

(144) WALL (DIVISION). (a) *Building division*. A wall used for separation between 2 buildings on the same property identical in construction to a party wall.

Note: See Appendix A for further explanatory material.

(b) *Fire division*. A wall extending from the lowest floor level to or through the roof to restrict the spread of fire.

(145) WALL (EXTERIOR). Any outer enclosing wall of a building or structure.

(146) WALL (FRAMING). Wall framing shall include columns, studs, beams, girders, lintels and girts.

(147) WALL (HOLLOW BONDED). Wall built of masonry units with or without any air space within the wall, and in which the facing and backing of the wall are bonded together with masonry units.

(148) WALL (NONBEARING EXTERIOR). Wall which supports no vertical load other than its own weight.

(148a) WALL (NONBEARING INTERIOR). See "Partition."

(149) WALL (PANEL). An exterior nonbearing wall in skeleton construction.

(150) WALL (PARAPET). That part of a wall entirely above the roof line.

(151) WALL (PARTY). Walls used for separation between 2 buildings on the property line between adjoining properties.

Note: See Appendix A for further explanatory material.

(152) WALL (RETAINING). Wall used to resist laterally imposed pressures.

(153) WALL (VENEERED). Wall having facing which is attached to the backing but not so bonded as to exert common action under load.

(153a) "Warehouse" means a building or structure used primarily for the reception and storage of goods and merchandise.

(154) YARD (FRONT). An open, unoccupied space unobstructed to the sky, extending across the full width of a lot, or plot of land between the street line and the base of a front building wall. Unenclosed terraces, slabs or stoops without roofs or walls may project into this open space.

History: Cr. Register, June, 1972, No. 198, eff. 1-1-73; renum. (1) to be (1a), r. and recr. (10), (54), (67) and (121), cr. (1), (5a), (22a), (56a), (57a), (67a), (76a), (106a) and (148a), Register, September, 1973, No. 213, eff. 10-1-73; cr. (102a), (104a) and (105a), Register, December, 1974, No. 228, eff. 1-1-75; cr. (7a), (41a), (139a) and (153a) and am. (125), Register, December, 1976, No. 252, eff. 1-1-77; cr. (42a), (42b), (42c), (42d), and (120a), am. (139a), Register, December, 1977, No. 264, eff. 1-1-78; am. (23) to (26), (97) and (139a), r. (86) (c), Register, December, 1978, No. 276, eff. 1-1-79; cr. (16a), (71a), (79a) and (114a), Register, May, 1980, No. 293, eff. 6-1-80; am. (1) and (124), r. (123), r. and recr. (120), renum. (102a) to be (102b), renum. (114a) to be (114b), cr. (19a), (36a), (36b), (36c), (37a), (38a), (38b), (71b), (75a), (80a), (82a), (102a), (114a), (119a), (119b), (119c) and (130a), Register, December, 1981, No. 312, eff. 1-1-82; renum. (71a) to be (71c), cr. (68a), (71a), (86a) and (93a), Register, February, 1982, No. 314, eff. 3-1-82; r. and recr. (7a), renum. (19a) to be (19b), cr. (7b) and (19a), Register, June, 1983, No. 330, eff. 7-1-83; renum. (120a) to be (120b), cr. (3a), (57b), (58a), (58b) and (120a), r. and recr. (13), am. (86) (a), (104) and (120), Register, December, 1983, No. 336, eff. 1-1-84; am. (7b), Register, February, 1984, No. 338, eff. 3-1-84; cr. (5b), (11a) and (29a), am. (75a) and (99), r. and recr. (104) and (114a), Register, August, 1985, No. 356, eff. 1-1-86; reprinted to correct error in (99), Register, May, 1988, No. 389; am. (5), (5b), (33) and (99), renum. (36c), (71a) to (71c), (71m), (71o) and (71p) and am. (71o), cr. (6m), (17g), (17m), (36c), (71k), (71n) and (117m), r. and recr. (11a), (19b) and (82), r. (114b) and (138), Register, February, 1991, No. 423, eff. 4-1-91; renum. (16) and (80) to be (15m) and (79m), cr. (16), (79r), (80) and (104m), Register, March, 1992, No. 435, eff. 4-1-92; cr. (105e), Register, October, 1992, No. 442, eff. 5-1-93; cr. (2m), (41g), (89g), (90g), (103g), (120am) and (130g); renum. (41a) and (130a) to be (41m) and (130m), Register, August, 1993, No. 452, eff. 3-1-94; cr. (17n) and (125m), am. (64), (75a) (a) to (e), (82), (86) (b) and (104) (b), r. and recr. (82a), (104a), (115) and (120b), Register, January, 1994, No. 457, eff. 2-1-94; r. (79a), Register, March, 1995, No. 471, eff. 4-1-95; renum. (76a) to be (76b), cr. (76a), Register, August, 1995, No. 476, eff. 9-1-95; am. (7), r. and recr. (102), Register, December, 1995, No. 480, eff. 4-1-96; renum. (71o) to be ILHR 66.03 (4m), Register, June, 1996, No. 486, eff. 7-1-96; r. and recr. (16a), (71p), Register, October, 1996, No. 490, eff. 11-1-96; correction in (29) and (33) made under s. 13.93 (2m) (b) 6. and 7., Stats., Register, October, 1996, No. 490; r. and recr. (7), (102), (153a), cr. (29m), (29n) and (29o), Register, March, 1997, No. 495, eff. 4-1-97; cr. (2r), (41c), (52m), (81m), and (130d), Register, September, 1998, No. 513, eff. 10-1-98; am. (7) and (47), renum. (56a) to be (56m) and (119c) to be (119m), r. (60) and cr. (119e), Register, March, 2000, No. 531, eff. 4-1-00; renum. (71p) to be (71l), cr. (19m), (71p) and (103d) and r. and recr. (103g), Register, April, 2000, No. 532, eff. 7-1-00; renum. (1a) and (6m) to be (1m) and (1g), cr. (6m), (13m) and (114m), am. (11a), r. and recr. (42b), r. (104a), Register, September, 2000, No. 537, eff. 10-1-00.

Subchapter I — Standards for Classes of Construction

Comm 51.015 Scope. This chapter covers minimum standards for common types of building designs being constructed. This chapter does not specifically include standards for uncommon building designs such as shells, domes, space frames and similar types of designs. The standards contained in this chapter shall be used as a guide for uncommon building designs to achieve the degrees of safety intended by these standards.

History: Cr. Register, June, 1972, No. 198, eff. 1-1-73; renum. Register, September, 1973, No. 213, eff. 10-1-73; am. Register, January, 1994, No. 457, eff. 2-1-94; am. Register, September, 2000, No. 537, eff. 10-1-00.

Comm 51.02 General requirements. (1) FIRE-RESISTIVE RATINGS. The fire-resistive ratings shown in "Classes of Construction" Table 51.03-A are to specify the structural integrity end point for the time specified. For heat transmission end point requirements see s. Comm 51.042 (5).

(2) SUBSTITUTE. Substitution of a building element fire-resistive rating will be permitted in any class of construction providing it is equal to or better than the required fire-resistive rating as specified in Table 51.03-A.

(a) Construction requiring the use of noncombustible material shall not be replaced by combustible construction regardless of fire-resistive rating unless mentioned specifically under classes of construction standards.

(b) Noncombustible construction may be substituted for combustible construction provided the fire-resistive rating indicated in Table 51.03-A is equal to or better than that noted for combustible construction.

Note: See Comm 64.41 (1) for requirements pertaining to combustible ceiling materials used in conjunction with air-handling plenums.

(c) Fire-retardant treated wood exposed to high humidity or accelerated weathering shall be pressure impregnated and so identified. Subsequent to treatment, lumber 2 inches or less in thickness shall be dried to a moisture content of 19% or less, and plywood to a moisture content of 15% or less.

Note: The department will accept fire-retardant treated lumber and plywood which meet the standards of the American Wood Preservers Association, "Fire-Retardant Treatment by Pressure Processes," and ASTM D 2898, "Standard Methods of Test for Durability of Fire-Retardant Treatment of Wood."

(3) FLOOR FRAMING. (a) General. All floor framing shall satisfy the requirements of Table 51.03-A, unless more restrictive requirements are noted under the occupancy chapters of this code.

(b) *Permanent raised platforms.* 1. Permanent raised platforms shall be constructed of the types of materials and fire resistive properties as specified in:

a. Table 51.03-A line 3 or 4 for the appropriate class of construction and number of stories involved; or

b. Table 51.03-A line 18 for the appropriate class of construction, if the platform is directly supported by a structural floor system which satisfies the appropriate material and fire resistive properties as outlined in Table 51.03-A line 3 or 4.

2. Permanent raised platforms shall be designed and constructed to support the dead loads and live loads as specified in ss. Comm 53.10 and 53.11.

3. The highest floor level of a permanent raised platform which is constructed in accordance with subd. 1. b. may not be more than 3 feet above the structural floor.

4. The floor coverings of permanent raised platforms shall conform with s. Comm 51.07.

5. Spaces created between a permanent raised platform which is constructed in accordance with subd. 1. b. and the structural floor system supporting the platform may not be used for storage and other purposes, unless the platform floor system has at least a one-hour fire resistive rating.

6. Open sides of raised platforms shall be guarded in accordance with s. Comm 51.162.

(c) *Temporary platforms.* Temporary raised platforms may be provided and shall be designed and constructed to support the dead loads and live loads as specified in ss. Comm 53.10 and 53.11. A temporary raised platform to be used for more than 30 consecutive days shall conform with par. (b), the requirements for permanent raised floors.

(4) EXTERIOR WALL CONSTRUCTION. (a) All exterior walls which are in contact with the soil shall be of masonry or concrete except that all-weather wood foundations are permitted if constructed in accordance with the provisions outlined in s. Comm 53.64.

(b) Exposed exterior walls between the first floor structural system and grade shall be of masonry or concrete except as follows:

1. Walls may be constructed of material other than masonry or concrete providing the following conditions are satisfied:

a. The construction shall meet the requirements of Table 51.03-A for specified class of construction.

b. In buildings where the class of construction permits exterior walls to be of combustible construction, no floor level that is more than one level below the first floor framing system may have exterior walls constructed of combustible materials.

(c) 1. Except as provided in subd. 2., fenestration in-fill panels in the exterior walls of existing buildings of types 1, 2, 3, 5A and 5B construction meeting the percentage of openings requirements of Table 51.02-B shall be of noncombustible construction.

2. a. The studding and structural framework may be of fire retardant treated wood.

b. The interior finish of the in-fill panel may be of combustible materials providing the materials comply with the provisions of s. Comm 51.07.

c. Foam plastic insulation complying with the provisions of s. Comm 51.06 may be used in the construction of the in-fill panels provided the foam plastic is protected on both sides by an approved thermal barrier as specified in s. Comm 51.06 (3).

3. In-fill panels located in exterior walls required to have a fire-resistive rating need not be constructed to provide the hourly

rating provided the panels satisfy the requirements of this section.

4. The exterior finish of the in-fill panel shall comply with the requirements of Table 51.03-A for the class of construction of the building in which the panel is located except that the exterior finish of in-fill panels located in buildings of types 5A or 5B construction need not be of masonry.

Table 51.02-B
Maximum Total Area Of Windows Or Other Openings In Percent Of Total Exposed Wall Surface

Setback from Property Line or Other Walls on same property	CLASS OF CONSTRUCTION					
	1. Fire Resistive "A" 2. Fire Resistive "B" 3. Metal Frame Prot.		4. Heavy Timber 5A Ext. Masonry 5B Ext. Masonry	6. Metal Frame Unprotected	7. Wood Frame Protected	8. Wood Frame Unprotected
	Bearing Wall	Nonbearing wall				
Less than 5'	No openings	No openings	No openings	No openings	No openings	
5' to less than 10'	20% A Fire Window is Required	30% A Fire Window is Required	30%	No openings	No openings	
10' to less than 30'	30%	40%	40%	40%	40%	
30' or over	No limit	No limit	No limit	No limit	No limit	

(d) 1. Except as allowed under subd. 6, the maximum area of windows or other openings shall be as required by Table 51.02-B.

2. Table 51.02-B does not apply to property lines along streets.

3. The maximum percentage of openings in Table 51.02-B shall be calculated for each 100 lineal feet of wall measured in the plane of the wall. Wing walls, parapets or similar structures may not be used to increase the exposed wall area.

4. Fire windows required by Table 51.02-B shall comply with s. Comm 51.048.

5. Setbacks specified in Table 51.02-B shall be measured as specified in s. Comm 51.01 (115).

6. Where openings are permitted, and Table 51.02-B shows a numerical percentage of allowed openings, openings are allowed in excess of the given percentage, provided the excess openings are protected with automatic closing, 3-hour fire resistive door or shutter assemblies.

(5) INTERIOR WALL CONSTRUCTION. (a) Openings in partitions and interior bearing walls shall be protected if such walls serve as required building division, fire division or fire separation walls.

1. Openings shall be protected by approved fire door or fire window assemblies as specified in ss. Comm 51.047 and 51.048, or fire damper or fire curtain door assemblies as specified in s. Comm 51.0485.

Note: Openings in walls other than those specified above need not be protected except to satisfy structural integrity end point for the time specified.

(7) BUILDING LOCATIONS. (a) When the distance between buildings located on the same property is less than 10 feet, the following shall apply:

1. Where the combined gross area for these buildings, including the area between buildings, is less than that allowable for one building, the exterior wall shall satisfy minimum requirements listed for class of construction in Table 51.03-A.

a. Buildings classified as wood frame under s. Comm 51.03 (7) or (8) shall have exterior walls with a fire-resistive rating of not less than that required for these buildings when satisfying the 10 feet to 30 feet distance to property line shown in Table 51.03-A.

2. Where the combined gross area for these buildings, including the area between buildings, is greater than that allowable for one building, one of the opposing walls shall be not less than a

4-hour fire-resistive rated fire division wall or building division wall, whichever applies. Where buildings are of different classes of construction, the lesser allowable gross area shall apply.

(b) Buildings on the same property may be located less than 30 feet from each other with no restriction on the percentage of wall openings, provided the combined gross area of the buildings, including the area between the buildings, is no more than the area permitted by the occupancy chapters of this code.

(8) INTERIOR BALCONY OR MEZZANINE. Interior balconies or mezzanine floors shall have fire-resistive ratings as required for the story in which it is located.

(9) IMBEDDED MATERIAL. (a) *Structural members.* Pipes, wires, cables, ducts or other service equipment shall not be imbedded in the required fire-resistive protection of any structural member.

(b) *Assemblies.* Pipes, wires, cables, metallic ducts or other service equipment may be imbedded or installed:

1. As permitted in approved fire-rated assemblies; or

2. In fire-resistive assemblies of 2-hour rating or less in buildings of Types No. 4 to 8 construction. The pipe, wire, cable, metallic duct or other service equipment shall be contained within the fire-resistive rated assembly.

(10) EXPOSED EXTERIOR STRUCTURAL COLUMNS AND FRAMING. The required fire-resistive hourly rating may be omitted on non-combustible columns and framing when the building does not exceed 2 stories and the fire separation to the center of a street, or to the property line or buildings on the same property, is greater than 30 feet.

(11) PROTECTION OF VERTICAL OPENINGS. (a) Except as specified in ss. Comm 54.08, 55.09, 57.08 and in par. (b), stairways, elevator shafts and other vertical openings, which serve 2 or more floor levels, shall be enclosed with fire-resistive rated construction equal to or better than the hourly ratings specified in Table 51.03-A. Stairways serving as required means of egress shall comply with the requirements specified in s. Comm 51.18.

(b) *Exceptions.* Vertical openings need not be enclosed under the following conditions:

1. Serving and contained within individual living units;

2. Serving raised or depressed areas, open mezzanines or open balconies contained within a single story;

3. Serving 2 floor levels in buildings containing chs. Comm 54 to 58 or 60 to 62 occupancies provided:

- a. The opening is not a required means of egress; and
- b. The opening is separated from any exit access corridor or exit stairway by fire-resistive rated construction with at least the hourly rating specified for fire-rated enclosures in line 20 of Table 51.03-A; or

4. As permitted by chs. Comm 54 to 62.

(c) Openings in required exit enclosures shall be limited to exit doors serving public passageways and corridors or serving floors occupied by a single tenant.

(12) PARAPET WALLS. (a) Parapet walls shall be provided on exterior walls closer than 10 feet to a property line or to other buildings on the same property except as exempted under subd. 4. Parapet walls shall satisfy the following requirements:

- 1. Parapets shall not be less than 2 feet in height;
- 2. The minimum thickness of masonry parapets shall be 8 inches;
- 3. Parapets shall have fire-resistive ratings as specified for exterior walls in Table 51.03-A; and
- 4. Parapets are not required on exterior walls which front streets and alleys or where exterior walls connect with roofs of noncombustible construction. For the purposes of this requirement, built-up roof coverings of a class A rating, shall be considered as being noncombustible.

(b) All parapet walls shall be properly coped with noncombustible weatherproof material.

(13) FIRE DIVISION WALLS. (a) Fire division walls shall have not less than a 4-hour fire-resistive rating as specified in s. Comm 51.04 and shall comply with one of the following conditions:

1. a. Except as provided in subd. 1. b., the fire division wall shall extend 3 feet above the roof. Where a difference in roof elevations occurs at the fire division, the parapet height shall be measured from the lower roof elevation.

b. Where a difference in roof elevations occurs at the fire division wall in buildings of Type No. 4 construction with combustible exterior walls, Type No. 7 or No. 8 construction, the fire division wall shall extend above the lower roof to the high roof elevation and shall be unpierced. In all cases, the fire division wall shall extend at least 3 feet above the lower roof elevation.

2. The wall shall connect and make tight contact with roof decks of at least 2-hour fire-resistive noncombustible construction on both sides of the wall; or

3. The wall shall connect and make tight contact with roofs of noncombustible construction on both sides of the walls, and the roofs shall be noncontinuous at the wall. For the purposes of this requirement, built-up roof coverings, including those of a class A rating, shall be considered as being combustible and do not conform with the conditions of this requirement.

(b) Structural members shall not continue through or over the fire wall.

(c) 1. All openings in fire division walls shall be protected by fire-resistive door assemblies as specified in s. Comm 51.047.

2. The total area of all openings in any fire division wall in any one story shall not exceed 25% of the area of the wall in that story.

(14) DETERMINATION OF NUMBER OF STORIES. For purposes of establishing the maximum allowable stories in the various classes of construction stated in s. Comm 51.03, the number of stories shall be determined on the following basis:

Note: See Appendix A for further explanatory material.

Note: See ch. Comm 69 for definition of "story" relative to accessibility issues.

(a) The first floor shall be determined first and this level shall satisfy the following conditions:

- 1. Is the lowest floor having one or more required exits for that floor and for any floor above or below; and

a. If condition stated in subd. 1. is not satisfied, the highest floor level shall be considered the first floor.

2. a. The elevation of the first floor and the sills of all required exit discharges from the first floor shall be not more than 6 feet above an exit discharge grade.

b. Existing buildings to be licensed as child day care centers or to be converted to sheltered facilities for battered women shall comply with the requirements specified in ss. Comm 57.015 and 60.105.

(b) An interior balcony or mezzanine shall be considered as a story if:

1. The net floor area of the balcony or mezzanine exceeds one-third of the net main area enclosed within exterior walls or fire division walls, or both; or

2. The net floor area of the balcony or mezzanine exceeds one-third of the net floor area enclosed with the walls of a single living unit or single tenant space.

(c) Penthouse with a total area that exceeds 50% of the total roof area shall be counted as a story.

(d) Total number of stories shall include the first floor plus all stories above and those stories determined by pars. (b) and (c).

1. Floor levels satisfying the definition of basement, ground floor, attic, interior balcony and mezzanine floor, unless otherwise stated, shall not be counted as a story.

(15) DECORATIVE COMBUSTIBLE MATERIALS. Any combustible materials applied to a required noncombustible exterior surface of "0" hourly rated construction or better shall not exceed the surface area percentage specified in Table 51.02-A, within any 100 lineal feet of the building.

TABLE 51.02-A

Separation of Building From Property Line or Other Buildings ¹	Maximum Surface Area Percentage ²
Less than 10 feet	0
10 to 20 feet	10
20 to 30 feet	20
More than 30 feet	30

¹The maximum surface area percentage along a street is 30, regardless of the separation.

²Fire-retardant treated wood may be applied to all required noncombustible exterior surfaces of "0" hourly rated construction without limit.

(16) PROJECTIONS INTO SETBACKS. (a) Unenclosed terraces, slabs or stoops, without roofs or walls, may be located within required setbacks providing they are not greater than 7 inches above adjacent grade at any point and are in contact with the ground to prevent an exposed cavity which could promote fire or smoke. Grade changes from these appendages shall be of a gradual slope.

(b) Open cantilevers, including but not limited to roof overhangs and eaves, may project 2 feet into the required setback from property lines. These cantilevers shall not project into the required setbacks between buildings on the same property.

(c) Enclosed or partially enclosed appendages, including but not limited to decks, porches or ramps, shall not project into the required setbacks from property lines or buildings on the same property.

(18) ACCESS TO ATTIC AND ROOF. (a) *Attic.* Every attic compartment shall be provided with access from the floor level immediately below it. The access opening shall be at least 20 by 30 inches and shall be located above the stair landing or in an accessible location.

Note: A single access point to the attic from the floor level immediately below will be acceptable if all the attic compartments are interconnected with access openings of at least 20 by 30 inches.

(b) *Roof.* 1. Except as provided in subd. 2., all buildings more than 2 stories, or 25 feet in height, where the slope of the roof is less than 3 in 12, shall be provided with a means of access to the main roof from the floor level immediately below. The roof opening shall be at least 20 by 30 inches and shall be provided with a permanent ladder or stairway.

2. Roof access shall not be required in 3 story buildings without attic space.

(19) ATTIC COMPARTMENTALIZATION. (a) Except as provided in par. (b), attics of combustible construction shall be divided into areas not greater than 3,200 square feet as specified in this section.

1. Compartmentalization shall extend into the eave and soffit areas to provide a complete separation between compartments.

2. Panels for access openings in compartment walls shall be equipped with self-closing devices and shall normally be kept closed.

3. Materials used for attic compartmentalization shall be as specified in s. Comm 51.02 (24) (c).

(b) Attic compartmentalization need not be provided in buildings completely protected, including the attic space, by an automatic fire sprinkler system.

(20) CLASS OF CONSTRUCTION SEPARATION. (a) Except as provided in par. (b) and s. Comm 62.93, portions of buildings of different classes of construction, as specified in s. Comm 51.03, shall be separated by fire division walls as specified in s. Comm 51.02 (13) or the building classification will be reduced to the lowest class of construction utilized.

(b) A health care facility, parts of which are different types of construction as described in s. Comm 51.03, shall be classified as the lowest type of construction utilized, unless the different parts of the building are separated from one another by a separation wall in which case each part of the building shall be individually classified as to the appropriate type of construction. A separation wall:

1. Shall have a minimum fire-resistive rating of 2 hours;
2. Shall extend at least to the underside of the roof deck of the lowest part of the building to be separated; and
3. May not have structural members extend through or over it.

(21) HEIGHT LIMITATIONS. (a) Except as provided in par. (b), the height of buildings shall be limited as specified in the appropriate occupancy chapter for the building and as specified in s. Comm 51.03 and Table 51.03-A for the class of construction utilized.

(b) The height limitations specified in s. Comm 51.03 may be increased by one story and 10 feet in height in buildings, other than buildings within the scope of chs. Comm 58, 60 and 61, when the building is completely protected by an automatic fire sprinkler system and the system is supervised and monitored as specified in s. Comm 51.23 (9).

Note: See chs. Comm 54 to 61 for specific application of height increases. Tables 54.01-2, 57.02-3 and 59.12-2 already include the one story height increase.

(22) FIRE RESISTIVE RATINGS. (a) Except as provided in par. (b), the fire resistive ratings specified in chs. Comm 50 to 64 may be reduced in rating by one hour to a minimum of one hour in all buildings which are completely protected by an automatic fire sprinkler system and the system is supervised and monitored as specified in s. Comm 51.23 (9).

(b) The fire resistive rating may not be reduced for the following:

1. The fire-resistive ratings specified in ch. Comm 58;
2. The fire-resistive ratings specified for stairway enclosures in buildings more than 3 stories in height;
3. The fire-resistive ratings for buildings more than 60 feet in height; and
4. The fire-resistive ratings for buildings where increases in building area or building height due to automatic fire sprinkler system protection have been utilized.

(23) WOOD BLOCKING IN NONCOMBUSTIBLE RATED ASSEMBLIES AND ROOF ASSEMBLIES. Combustible wood blocking may be installed:

(a) At the intersection of roofs with exterior walls or parapet walls to fasten roof edging, roof membranes, facias and roofing expansion joints; and

(b) In noncombustible rated wall assemblies to fasten window frames, door frames, sinks, toilets and urinals, toilet partitions, grab bars, book shelves, and other similar components. In these applications, the amount of wood blocking shall not exceed that required to secure or fasten the item to the assembly.

(24) FIREBLOCKING OF CONCEALED SPACES. (a) *General.* 1. Fireblocking shall be installed in combustible concealed locations in accordance with this section.

2. Fireblocking shall be provided across the full width of intersections of interior and exterior walls with floors, ceilings and roof in order to cut off communication by fire through hollow concealed spaces and prevent both vertical and horizontal drafts.

3. Fireblocking shall be provided at openings around wires, vents, pipes, ducts and other penetrations in floors and ceilings at all levels to prevent vertical drafts.

4. Fireblocking shall be provided at openings around wires, vents, pipes, ducts and other penetrations in walls separating adjacent tenant spaces to prevent horizontal drafts.

5. Noncombustible fireblocking shall be provided between chimneys and wood framing at all floor levels.

6. Fireblocking shall be installed to remain securely in place when exposed to fire conditions.

7. The integrity of fireblocking shall be maintained.

(b) *Specific locations.* 1. Concealed spaces in stud walls or furred walls shall have fireblocking placed immediately above and below the junction of any floor construction with the walls, or shall be fireblocked the full depth of the joist.

2. Concealed spaces between vertical stud walls or partitions and the spaces created by soffits, dropped ceilings, cove ceilings and similar areas shall be fireblocked.

3. All concealed spaces between stair stringers at the top and bottom of the stair run shall be fireblocked.

4. All spaces between chimney and wood framing shall be solidly filled with noncombustible material at floor levels.

5. a. Except as provided in subd. 5. b. and c., wood floors laid on noncombustible construction with sleepers or furring strips shall be fireblocked so that no open space under the flooring will exceed 100 square feet.

b. Fireblocking is required only at the ends of each lane in a bowling facility.

c. Fireblocking is not required for slab-on-grade floors in gymnasiums unless the floor is partitioned into separate rooms or areas by permanent stud wall or furred wall construction.

Note: Subd. 1 still requires fireblocking under permanent walls that serve to subdivide the gymnasium floor.

(c) *Fireblocking materials.* Where combustible material is allowed under this section, fireblocking shall consist of one of the following:

1. Lumber with a nominal thickness of at least 2 inches.
2. Two layers of lumber, each with a nominal thickness of one inch, with staggered lap joints.
3. Wood structural panel or particle board with a nominal thickness of 3/4 inch thick with joints backed.
4. Gypsum board with a minimum thickness of 1/2 inch.
5. Cement fiber board.
6. Fiberglass or mineral wool batts or blankets.
7. Caulk, putty or drywall compound.
8. Other noncombustible materials.

(25) COMBUSTIBLE STORAGE. Combustible materials covered under the scope of NFPA 230 shall be stored in accordance with the requirements of NFPA 230.

Note: NFPA 230, Standard for the Fire Protection of Storage, is intended to apply to a broad range of combustible materials stored indoors and outdoors. Examples include plastics, rubber tires, baled cotton and roll paper. Configurations include palletized, solid piled, in bin boxes, on racks or on shelves. Exemptions include high-hazard materials, such as flammable liquids and unpackaged bulk material, such as grain or coal.

History: Cr. Register, June, 1972, No. 198, eff. 1-1-73; r. (9) and (10), renum. (3) to be (4), (4), (5), (6), (7), (8) to be (6), (7), (8), (9), (10), am. (2) (a) cr. (3), (5), (11), (12), (13) and (14), Register, September, 1973, No. 213, eff. 10-1-73; am. (14) (d), Register, February, 1974, No. 218, eff. 3-1-74; r. and recr. (12) (a); am. (13) (c), Register, May, 1974, No. 221, eff. 6-1-74; cr. (11) (c) and (15), Register, July, 1974, No. 223, eff. 8-1-74; cr. (16) and (17), Register, December, 1974, No. 228, eff. 1-1-75; am. (5) (a) 1. and (14) (e) 1., cr. (18), Register, December, 1975, No. 240, eff. 1-1-76; am. (16) (b), Register, July, 1976, No. 247, eff. 8-1-76; cr. (2) (c), Register, December, 1976, No. 252, eff. 1-1-77; am. (15) and cr. (19), Register, December, 1977, No. 264, eff. 1-1-78; r. (16) and (17), Register, May, 1978, No. 269, eff. 7-1-78; am. (4) (a), (18) and (19), cr. (15) (a) and (20), Register, December, 1978, No. 276, eff. 1-1-79; am. (11) (a) and (c) (intro.), (13) and (19), r. and recr. (6) (b), Register, January, 1980, No. 289, eff. 2-1-80; r. and recr. (11), am. (14) (a) 2., r. (14) (a) 3., Register, December, 1981, No. 312, eff. 1-1-82; reprinted to correct error in (14) (a) 2., Register, February, 1982, No. 314; am. (11) (a) and (19), Register, October, 1982, No. 322, eff. 11-1-82; cr. (4) (c) and (13) (c), r. (6), am. (11) (b) 3., (14) (a) 2. and (20), Register, December, 1983, No. 336, eff. 1-1-84; am. (4) (c) 2. c., (9), (11) (b) 3., (13) (c) 2., (14) (b) and (18) (b), r. and recr. (13) (a) 1., Register, August, 1985, No. 356, eff. 1-1-86; emerg. cr. (21) and (22), eff. 9-6-86; cr. (21) and (22), Register, November, 1986, No. 371, eff. 12-1-86; am. (3) (a), (12) (a) 4., (13) (a) 3., cr. (3) (c) and (d), r. (4) (b) 1. b. and (14) (d), r. and recr. (11) (b) 3., (14) (a) 2. a., (b) and (20) (b), renum. (14) (e) to be (14) (d) and am. Register, February, 1991, No. 423, eff. 4-1-91; renum. (3) (a), (c) and (d) to be (a), (b) and (c) and am. (a), (b) 1. intro., b. and 3. and (c), am. (7) (a) 1. and 2. and (9), cr. (7) (b), (16) and (23), r. and recr. (15), Register, January, 1994, No. 457, eff. 2-1-94; cr. (22) (b) 5., Register, March, 1994, No. 459, eff. 4-1-94; cr. (4) (b) 1. b., Register, March, 1995, No. 471, eff. 4-1-95; correction in (22) (b) 5. made under s. 13.93 (2m) (b) 7., Stats., Register, October, 1996, No. 490; r. (22) (b) 5., Register, April, 1998, No. 508, eff. 5-1-98; am. (4) (c) 1., (5) (a) 1., (15) and (19) (a) (intro.), cr. (4) (d) and Table 51.02-B, (19) (a) 3., (24) and (25), renum. Table 51.02 to be Table 51.02-A, Register, March, 2000, No. 531, eff. 4-1-00.

Comm 51.03 Classes of construction standards.

(1) FIRE RESISTIVE TYPE A (NO. 1). (a) A building is of fire-resistive construction if all the walls, partitions, piers, columns, floors, ceilings, roof and stairs are built of noncombustible material, with a fire-resistive rating as specified in Table 51.03-A.

(b) A building of this classification shall be limited in height in accordance with Table 51.03-C.

(c) Stairs and stair platforms shall be constructed of noncombustible material.

(d) Doors and windows may be of wood except as otherwise specified in s. Comm 51.02 (5), Table 51.02-B, ss. Comm 51.17, 51.18, 51.19 and 51.20, or in the occupancy chapters of this code.

(e) Bays, oriels, and similar exterior projections from the walls shall be constructed of material with fire-resistive ratings as required for exterior walls.

(f) The wall construction behind a mansard shall extend to the underside of the roof deck and shall have a fire-resistive rating of not less than that specified for exterior walls in Table 51.03-A.

(g) Penthouses and other roof structures shall have enclosing walls of noncombustible construction and roof framing and coverings shall be equal to that specified in Table 51.03-A. Wood cooling towers are permitted.

(j) In required fire-resistive floor and roof assemblies one electric outlet box, not exceeding 16 square inches in area, may be installed in such ceilings in each 90 square feet of ceiling area. Recessed electric fixtures shall have protection boxes built above the fixture, constructed of approved fire-resistant material of rating equal to that of the ceiling, to cover the opening in case fixture is displaced. Duct openings in ceilings shall be protected by fire dampers.

(2) FIRE-RESISTIVE TYPE B (NO. 2). (a) A building is of fire-resistive construction if all the walls, partitions, piers, columns, floors, ceilings, roof and stairs are built of noncombustible material, with a fire-resistive rating as specified in Table 51.03-A.

(b) A building of this classification shall be limited in height in accordance with Table 51.03-C.

(c) Where roof framing is greater than 20 feet above the floor, or highest level of any balcony, roof decks may be:

1. Matched or splined wood roof decking of not less than 2 inches in nominal thickness;

2. Solid lumber not less than 3 inches in nominal thickness, set on edge securely fastened together;

3. Approved 1¹/₈ inch thick plywood with exterior glue, tongue and groove with all end joints staggered and butting on centers of beams spaced not over 4 feet apart; or

4. Other forms of roof decks, if of noncombustible material.

(d) Stairs and stair platforms shall be constructed of noncombustible material.

(e) Doors and windows may be of wood except as otherwise specified in s. Comm 51.02 (5), Table 51.02-B, ss. Comm 51.17, 51.18, 51.19 and 51.20, or in the occupancy chapters of this code.

(f) Bays, oriels, and similar exterior projections from the walls shall be constructed of material with fire-resistive ratings as required for exterior walls.

(g) The wall construction behind a mansard shall extend to the underside of the roof deck and shall have a fire-resistive rating of not less than that specified for exterior walls in Table 51.03-A.

(h) Penthouse and other roof structures shall have enclosing walls of noncombustible construction and roof framing and coverings shall be equal to that specified in Table 51.03-A. Wood cooling towers are permitted.

(3) METAL FRAME-PROTECTED (NO. 3). (a) A building is of metal frame protected construction if the structural parts and enclosing walls are of metal, or metal in combination with other noncombustible materials, with time resistance ratings as set forth in Table 51.03-A.

(b) A building of this classification shall be limited in height in accordance with Table 51.03-C.

(c) Stairs and stair platforms shall be constructed of noncombustible material.

(d) Bays, oriels and similar exterior projections from the walls shall be constructed of material with fire-resistive ratings as required for exterior walls.

TABLE 51.03-A
CLASSES OF CONSTRUCTION FIRE-RESISTIVE RATINGS IN HOURS

BUILDING ELEMENT	MODIFYING CONDITIONS	TYPES OF CONSTRUCTION										APPLICABLE NOTES
		SEE NOTES f, g, n BLDG SETBACK DIST. TO P/L OR TO OTHER BLDG. ON SAME PROP.	FIRE RESISTIVE TYPE A	FIRE RESISTIVE TYPE B	METAL FRAME PROTECTED	HEAVY TIMBER	EXTERIOR MASONRY, PROT	EXTERIOR MASONRY, UNPROT	METAL FRAME UNPROTECTED	WOOD FRAME PROTECTED	WOOD FRAME UNPROTECTED	
NUMBER OF STORIES		No. 1	No. 2	No. 3	No. 4	No. 5A	No. 5B	No. 6	No. 7	No. 8		
1. INTERIOR SUPPORTS (columns, piers, frame legs, posts)	Over 8 stories or more than 85 ft. in height		NC-4	NC-3	NP	NP	NP	NP	NP	NP	NP	a d
2.	8 stories or 85 ft. in height or less		NC-3	NC-2	See s. ILHR 51.03 (3) NC-1	See s. ILHR 51.03 (4) H.T. or NC-1	See s. ILHR 51.03 (5) 1	See s. ILHR 51.03 (5) 0	See s. ILHR 51.03 (6) NC-0	See s. ILHR 51.03 (7) 1	See s. ILHR 51.03 (8) 0	a d
3. FLOOR FRAMING (beams, girders, joists, slabs, deck)	More than 2 stories		NC-3	NC-2	See s. ILHR 51.03 (3) NC-1	See s. ILHR 51.03 (4) H.T. or NC-1	See s. ILHR 51.03 (5) 1	See s. ILHR 51.03 (5) 0	See s. ILHR 51.03 (6) NC-0	1	0	a
4.	2 stories or less		NC-2	NC-1	NC-1	See s. ILHR 51.03 (4) H.T. or NC-1	1	0	See s. ILHR 51.03 (6) NC-0 or 1	1	0	a
5. ROOF FRAMING (trusses, beams, girders, joists, frame rafters, purlins, deck)	Over 8 stories or more than 85 ft. in height		NC-2	NC-1-1/2	NP	NP	NP	NP	NP	NP	NP	a
6.	3 to 8 stories or 85 ft. in height or less		NC-2	NC-1-1/2	NC-1	See s. ILHR 51.03 (4) H.T. or NC-1	1	0	NC-0	1	0	a
7.	2 stories or under 25 ft. in height		NC-1	NC-1	NC-1	See s. ILHR 51.03 (4) H.T. or NC-1	See s. ILHR 51.03 (5) 1	See s. ILHR 51.03 (5) 0	NC-0	See s. ILHR 51.03 (7) 1	0	a
8.	1 story - roof framing more than 20 ft. above fl.		NC-0	See s. ILHR 51.03 (2) NC-0	NC-0	See s. ILHR 51.03 (4) H.T. or NC-1	0	0	0	0	0	a
9.	1 story - roof framing 20 ft. or less above fl.		NC-1	NC-1	NC-1	See s. ILHR 51.03 (4) H.T. or NC-1	1	0	0	See s. ILHR 51.03 (7) 1	0	a
10. ROOF COVERING			CLASS A	CLASS A	CLASS A	CLASS B	CLASS B	CLASS B	CLASS C	CLASS C	CLASS C	a
11. EXTERIOR WALLS & COURT WALLS (Includes columns in the plane of the wall and outward therefrom. Does not include interior furring attached to inside surface of wall.)	Bearing - Less than 10 ft.		NC-4	NC-3	NC-2	NC-2	2	2	NC-2	See s. ILHR 51.03(7)(a) 4	See s. ILHR 51.03(8)(d) 4	a d e f
12.	Bearing - 10 ft. to 30 ft. inclusive		NC-3	NC-2	NC-3/4	1	2	1	NC-0	1	0	a c d e f
13.	Bearing - Over 30 ft.		NC-2	NC-1	NC-0	1	2	1	NC-0	1	0	a c d e f k
14.	Nonbearing - Less than 10 ft.		NC-2	NC-2	NC-1	NC-1	2	1	NC-1	See s. ILHR 51.03(7)(e) 4	See s. ILHR 51.03(8)(d) 4	a d e f
15.	Nonbearing - 10 ft. to 30 ft. inclusive		NC-1	NC-1	NC-0	1	2	1	NC-0	1	0	a c d e f
16.	Nonbearing - Over 30 ft.		NC-0	NC-0	NC-0	3/4	1	0	NC-0	1	0	a c d e f h k
17. INTERIOR WALLS BEARING			NC-3	NC-2	NC-1	1	1	1	NC-0	1	0	a j
18. PARTITIONS			NC-0	NC-0	NC-0	0	0	0	0	0	0	a j
19. REQUIRED EXIT CORRIDOR ENCLOS.			NC-2	NC-2	NC-1	1	1	1	1	1	1	a
20. FIRE ENCLOSURE (stairways, elevators, vertical shafts)	Over 3 stories		NC-2	NC-2	NC-2	2	2	1	1	1	1	a f
	3 stories or less		NC-2	NC-2	NC-1	1	1	1	1	1	1	a f
21. PENTHOUSE WALLS			NC-0	NC-0	NC-0	0	NC-0 or 3/4	NC-0 or 3/4	0	0	0	a h
22. PENTHOUSE ROOF			NC-0	NC-0	NC-0	0	0	0	0	0	0	a b

KEY TO ABBREVIATIONS

NC - Noncombustible
NP - Not Permitted
H.T. - Heavy Timber
P/L - Property Line

KEY EXAMPLE TO READING CHART

0 = 0, No Hour Rating
1 = Combustible or Noncombustible 1-Hour Rating
NC-0 = Noncombustible 0-Hour Rating

a - See occupancy sections of the code for other basic requirements and more restrictive limitations.
b - Roof covering same as for main building.
c - Walls of solid wood 4 inches in thickness are acceptable as equal to 1-hour fire-resistive rating.
d - Fire-resistive requirements also apply for those bracing members required for gravity loading.
e - Refer to Table 51.03-B for allowable areas for windows and other openings in exterior walls.
f - For exceptions, refer to s. ILHR 51.02.
g - Setbacks and distances to P/L or other buildings on same property do not apply to P/L along streets.
h - Approved fire-retardant treated wood will be accepted in lieu of 3/4-hour fire-resistive ratings.
j - For openings in partitions and interior bearing walls, see s. ILHR 51.02.
k - Hourly ratings specified as for fire exposure from the inside of the building only.
m - See Table 51.03-C concerning height limitations.
n - Setbacks shall be measured as specified in ILHR 51.01 (115).
p - The elevator machine rooms shall have the same fire-resistive rating specified in line 20 for fire enclosures. Where the elevator machine room is the only room located above the roofline of a building, the fire-resistive rating for fire enclosures is not required.

**TABLE 51.03-C
HEIGHT LIMITATIONS
BASED ON CLASS OF CONSTRUCTION**

Class of Construction	Sprinklered ^{a,b}		Nonsprinklered	
	Height (in feet)	Number of Stories ^c	Height (in feet)	Number of Stories ^c
Type 1	No limit	No limit	60 ^d	No limit
Type 2	95	9	60 ^d	8
Type 3	85	5	60 ^d	4
Type 4	85	5	60 ^d	4
Type 5A	60	5	50	4
Type 5B	50	4	40	3
Type 6	60	4	50	3
Type 7	50	4	40	3
Type 8	45	3	35	2

^a An automatic fire sprinkler system designed and installed in accordance with s. Comm 51.23 is provided throughout the entire building.

^b Section Comm 51.02 (21) and (22) may limit or restrict the credit for sprinklers as it applies to the maximum height or number of stories permitted depending upon the type of occupancy involved or whether a reduction in fire-resistive ratings has been utilized.

^c The occupancy chapters, chs. Comm 54 to 62, may further limit or restrict the maximum number of stories based upon the type of occupancy involved or the number or type of occupants.

^d Section Comm 52.01 requires the installation of sprinklers for buildings more than 60 feet in height.

(e) The wall construction behind a mansard shall extend to the underside of the roof deck and shall have a fire-resistive rating of not less than that specified for exterior walls in Table 51.03-A.

(4) **HEAVY TIMBER (NO. 4).** (a) A building is of heavy timber construction if the structural frame consists of heavy timber or heavy timber in combination with metal, reinforced concrete or masonry, and all building elements are as set forth in Table 51.03-A unless otherwise exempted.

(b) A building of this classification shall be limited in height in accordance with Table 51.03-C.

(c) **Columns.** 1. Wood columns shall be not less than 8 inches, nominal, in any dimension when supporting floor loads and not less than 6 inches, nominal, in least dimension and not less than 8 inches, nominal, in other dimension when supporting roof loads only.

2. All wood columns in the structural frame shall be superimposed, end to end, one above the other, and joined by metal or wood connectors.

Note: See structural ch. Comm 53 for design requirements.

(d) **Floor framing.** 1. Beams and girders of wood shall be not less than 6 inches, nominal, in any dimension and not less than 45 square inches in actual cross-sectional area.

2. Wood arches which support floor loads shall be not less than 8 inches, nominal, in any dimension.

3. Framed timber trusses supporting floor loads shall have members of not less than 8 inches, nominal, in any dimension.

4. Floor framing and structural framing of material other than wood shall have a fire-resistive protection of not less than one hour.

(e) **Roof framing.** 1. Beams and girders of wood shall be not less than 6 inches, nominal, in any dimension and not less than 45 square inches in actual cross-sectional area.

2. Wood arches, timber trusses, purlins and rafters for roof construction shall have members not less than 4 inches, nominal, in width and not less than 6 inches, nominal, in depth. Spaced members may be composed of 2 or more pieces not less than 3 inches, nominal, in thickness when blocked solidly throughout their intervening spaces or when such spaces are tightly closed by a continuous wood cover plate of not less than 2 inches, nominal,

in thickness, secured to the underside of the members. Splice plates shall be not less than 3 inches, nominal, in thickness.

(f) **Floors.** Wood floor construction shall be tongued and grooved, or splined lumber not less than 3 inches nominal thickness, or of solid lumber placed on edge and securely fastened together to make a floor not less than 4 inches, nominal, in thickness. A top layer of flooring of one inch nominal thickness shall be placed over all such floor construction.

(g) Stair construction may be of wood in buildings not exceeding 3 stories in height. In buildings of 4 or more stories, all stairs, platforms and stair construction shall be constructed of noncombustible material.

(h) **Roofs.** Roof decks shall be:

1. Matched or splined wood roof decking of not less than 2 inches in nominal thickness;

2. Solid lumber not less than 3 inches in nominal thickness, set on edge securely fastened together;

3. Approved 1¹/₈ inch thick plywood with exterior glue, tongue and groove with all end joints staggered and butting on centers of beams spaced not over 4 feet apart; or

4. Other forms of roof decks, if of noncombustible material.

(i) Bays, oriels, and similar exterior projections from the walls shall be constructed of material with fire-resistive ratings as required for exterior walls.

(5) **EXTERIOR MASONRY, PROTECTED AND UNPROTECTED (NOS. 5A AND 5B).** (a) A building is of protected or unprotected exterior masonry construction if all exterior walls are constructed of masonry or reinforced concrete or of other materials in combination with a minimum 6 inch nominal masonry wall and all building elements are as set forth in Table 51.03-A unless otherwise exempted.

(b) A building of this classification shall be limited in height in accordance with Table 51.03-C.

(c) The interior structural framing shall be metal, reinforced concrete, masonry or wood. Fire protection of metal or wood structural members shall be as specified in Table 51.03-A.

(d) In walls where fire protection is required, the bottom of lower flange of steel lintels supporting load-bearing masonry shall be protected for openings exceeding 12-foot spans.

(e) Floors, roofs, partitions and stairs may be of wood, but no joist, rafter, stud, stringer, truss member or top and bottom member of a wood I-Beam may be less than 2 inches in nominal thickness.

(f) Bays, oriels and similar exterior projections from the walls shall be constructed of material with fire-resistive ratings as required for exterior walls.

(g) The portion of exterior wall above the bearing points of the roof structural framing system and enclosing non-occupied space shall be considered part of the roof construction and shall comply with the requirements of Table 51.03-A for roof framing.

(6) **METAL FRAME-UNPROTECTED (NO. 6).** (a) A building is of metal frame unprotected construction if the enclosing walls are of unprotected metal or unprotected metal in combination with other noncombustible materials and all building elements are as set forth in Table 51.03-A unless otherwise exempted.

1. Heavy timber may be used for interior columns and floor framing.

2. Interior mezzanines and balconies within the first story may be constructed of one-hour fire-resistive construction.

(b) A pole building is considered type No. 6, metal frame unprotected construction, provided the following conditions are satisfied:

1. The poles supporting the roof only shall be at least 6 inches by 8 inches nominal in dimension. Poles supporting floors shall be 8 inches by 8 inches nominal in dimension. Poles may be built

up from individual 2-inch nominal lumber if the pieces are bolted or glued and nailed together;

2. The girts shall be of noncombustible, fire-retardant treated wood or heavy timber construction;

3. The enclosing wall skin shall be of noncombustible materials. A non-structural 2" x 6" nominal wood skirt is permitted if it is in contact with the ground or foundation;

4. The roof cover shall have a class B rating or better; and

5. All other requirements of this section and Table 51.03-A are satisfied.

(c) A building of this classification shall be limited in height in accordance with Table 51.03-C.

(d) Stairs and stair platforms may be of wood with stringers not less than 2 inches in nominal thickness.

(e) Bays, oriels and similar exterior projections from the walls shall be constructed of material with fire-resistive ratings as required for exterior walls.

(7) WOOD FRAME—PROTECTED (NO. 7). (a) A building is of wood frame protected construction if the structural parts and enclosing walls are of protected wood, or protected wood in combination with other materials, with fire-resistive ratings at least equal to or better than those set forth in Table 51.03-A. Except as specified in s. Comm 51.03 (5) (a), if such enclosing walls are veneered, encased or faced with stone, brick, tile, concrete, plaster or metal, the building is also termed a wood frame protected building.

(b) A building of this classification shall be limited in height in accordance with Table 51.03-C.

(c) Floors, roofs, partitions and stairs may be of wood, but no joist, rafter, stud, or stringer, truss member or top and bottom member of a wood I-Beam may be less than 2 inches in nominal thickness.

(d) The structural members supporting the finished ceiling in the topmost story shall be protected on the underside by fire-resistive material acceptable in systems approved for one-hour fire-resistive ratings as covered in s. Comm 51.04.

(e) Buildings of wood frame protected construction may be located less than 10 feet from a property line provided any wall closer than 10 feet from a property line is a 4-hour fire division wall, without openings, as specified in s. Comm 51.02 (13).

(f) Bays, oriels and similar exterior projections from the walls shall be constructed of material with fire-resistive ratings as required for exterior walls.

(8) WOOD FRAME—UNPROTECTED (NO. 8). (a) A building is of wood frame unprotected construction if the structural parts and enclosing walls are of unprotected wood, or unprotected wood in combination with other materials as set forth in Table 51.03-A. If such enclosing walls are veneered, encased or faced with stone, brick, tile, concrete, plaster or metal, the building is also termed a wood frame unprotected building.

(b) A building of this classification shall be limited in height in accordance with Table 51.03-C.

(c) Floors, roofs, partitions and stairs may be of wood but no joist, rafter, stud, stringer, truss member or top and bottom member of wood I-Beam may be less than 2 inches in nominal thickness.

(d) Buildings of wood frame unprotected construction may be located less than 10 feet from a property line provided any wall closer than 10 feet from a property line is a 4-hour fire division wall, without openings, as specified in s. Comm 51.02 (13).

History: Cr. Register, June, 1972, No. 198, eff. 1-1-73, am. table A and (1) (d), renum. (1) (e) 1. to be (f), (1) (f) 1. a. to be (1) (f) 1., (1) (f) (g) (h) (i) to be (1) (g) (h) (i) (j), (2) (f) 1. to be (2) (g), (2) (g) 1. a. to be (2) (g) 1., (2) (g) (h) (i) to be (2) (h) (i) (j), (3) (d) 1. to be (e), (3) (e) 1. a. to (3) (e) 1., (7) (b) to be (c), (7) (c) to be (b), am. (2) (e), r. (4) (e) 3., r. and recr. (6) (a), cr. (7) (d), Register, September, 1973, No. 213, eff. 10-1-73; r. and recr. (6) (a), Register, May, 1974, No. 221, eff. 6-1-74; cr. (5) (a) 1. and 2., am. table B and (5) (f) and r. and recr. (5) (g), Register, July, 1974, No. 223, eff. 8-1-74; am. (1) (d) 1. and (2) (e) 1., Register, December, 1974, No. 228, eff. 1-1-75; cr. (6) (a) 3., Register, December, 1977, No. 264, eff. 1-1-78; renum.

(6) (b) to (d) to be (6) (c) to (e), cr. (6) (b), (7) (e) and (8) (d), am. (1) (f) (intro.), (h), (i), (2) (g) (intro.), (i), (j), (3) (e) (intro.), (4) (a), (5) (a) (intro.) and (8) (a), Register, December, 1978, No. 276, eff. 1-1-79; am. (1) (d) 1., (2) (e) 1., (5) (g) (intro.) and (6) (a) 3., cr. (5) (a) 3., Register, January, 1980, No. 289, eff. 2-1-80; am. (5), (7) (a), (b) and (e), (8) (d), cr. (9) (f), Register, December, 1981, No. 312, eff. 1-1-82; am. (5) (a) and (7) (f), Register, October, 1982, No. 322, eff. 11-1-82; am. table A, (3) (d) and (6) (c), r. (1) (h) and (i), (2) (f) and (j) and (6) (a) 13., cr. (4) (i) and (7) (g), r. and recr. (5) (h), Register, December, 1983, No. 336, eff. 1-1-84; am. (7) (f), Register, August, 1985, No. 356, eff. 1-1-86; r. and recr. table A, (1) (b), (2) (b), (3) (b), (4) (b), (5) (b), (6) (c), (7) (b) and (8) (b), cr. table c, r. (1) (d) 1., (2) (e) 1. and (7) (f), renum. (7) (g) to be (f), Register, March, 1991, No. 423, eff. 4-1-91; am. tables A and B, (4) (g), (5) (e), (7) (c) and (8) (c), r. and recr. (1) (f), (2) (g) and (3) (e), r. (5) (g), renum. (5) (h) to be (5) (g), Register, January, 1994, No. 457, eff. 2-1-94; am. Table 51.03-B, Register, December, 1995, No. 480, eff. 4-1-96; r. and recr. Table 51.03-B, Register, March, 1997, No. 495, eff. 4-1-97; r. (1) (a) 1., Register, September, 1998, No. 513, eff. 10-1-98; am. (1) (d) and (2) (e), r. Table 51.03-B, Register, March, 2000, No. 531, eff. 4-1-00.

Subchapter II — Fire-Resistive Standards for Materials of Construction

Comm 51.04 Scope. This section shall include standards applicable to various types of fire-resistive construction. Requirements established herein are considered minimum safety standards and will not necessarily result in the most advantageous insurance rates.

History: Cr. Register, February, 1971, No. 182, eff. 7-1-71; r. eff. 8-1-71 and recr. eff. 1-1-72, Register, July, 1971, No. 187.

Comm 51.042 General requirements. (1) Construction details and the quality of materials used for fire resistive assemblies shall be those used by the testing laboratory for the listed test assembly or those recognized by good engineering practice, including:

(a) The addition of mineral fiber or glass fiber insulation within a stud cavity without reducing the fire resistive rating of wall or partition assembly when not specified as the listed assembly.

(b) The substitution of studs with greater depths than those specified in a listed wall or partition assembly without reducing the fire resistive rating of the assembly.

(c) An increase in the distance between parallel rows of studs, such as in chase wall assemblies, greater than those specified in listed wall or partition assemblies without reducing the fire resistive rating of the assembly.

(2) The minimum fire-resistive protection of a connection shall be equal to the maximum required for the members to which it is attached.

(3) For structural components with a fire-resistive rating obtained by test with restrained ends, the supporting structure shall be designed to provide for this restraint.

(4) (a) All products manufactured and tested according to ASTM standard methods prior to the effective dates of the standards specified in ASTM E-119 shall be accepted unless the ASTM standard method used in the test is judged to be inadequate in comparison with the most currently adopted standard method.

(5) The heat transmission requirements of ASTM E-119, with the exception of high hazard areas, penal and health care facilities and warehouses for combustible materials, may be reduced to one-half (1/2) of the hourly rating required by this code, but not less than one hour.

Note: See s. A.52.011 of Appendix A for additional information pertaining to high hazard occupancies.

(a) The fire-resistive rating for structural integrity required by this code shall be maintained where the heat transmission criteria has been reduced.

(6) The use of fire-resistive protection implies consent by owner to maintain material in a serviceable condition. Where this protection is concealed, provisions shall be made for periodic visual inspection of the structural insulating material at each story.

(7) In one-hour fire-resistive rated construction and in living unit separations as specified in s. Comm 57.01 (2), the ceiling may be omitted over unusable crawl space not more than 42 inches in height and the flooring may be omitted where unusable space occurs above.

(8) Structural elements which support building components or assemblies required to have a fire-resistive rating shall be protected to afford at least the same fire-resistive rating of the component or assembly supported.

History: Cr. Register, February, 1971, No. 182, eff. 7-1-71; r. eff. 8-1-71, and recr. eff. 1-1-72, Register, July, 1971, No. 187; cr. (7), Register, December, 1981, No. 312, eff. 1-1-82; cr. (8), Register, December, 1983, No. 336, eff. 1-1-84; am. (7), Register, August, 1985, No. 357, eff. 1-1-86; r. and recr. (1), am. (5) (intro.), Register, March, 1991, No. 423, eff. 4-1-91; renum. (2) (a) and (4) (a) to be (2) and (4) and am. (4), Register, January, 1994, No. 457, eff. 2-1-94; r. (1) (d), Register, March, 2000, No. 531, eff. 4-1-00.

Comm 51.043 Approved rating methods. (1) Ratings of fire-resistive assemblies shall be determined by one of the following methods:

- (a) Test by approved testing laboratories.
- (b) Typical examples as listed in this code in lieu of approved test (see s. Comm 51.045).
- (c) Approved method of calculation in lieu of approved test (see s. Comm 51.046).

History: Cr. Register, February, 1971, No. 182, eff. 7-1-71; r. eff. 8-1-71, and recr. eff. 1-1-72, Register, July, 1971, No. 187; am. (1) (a), Register, March, 2000, No. 531, eff. 4-1-00.

Comm 51.044 Testing laboratories. History: Cr. Register, February, 1971, No. 182, eff. 7-1-71; r. eff. 8-1-71, and recr. eff. 1-1-72, Register, July, 1971, No. 187; am. Register, December, 1977, No. 264, eff. 1-1-78; am. table, Register, December, 1978, No. 276, eff. 1-1-79; r. and recr., Register, December, 1981, No. 312, eff. 1-1-82; r. and recr. table, Register, December, 1983, No. 336, eff. 1-1-84; r. and recr. table, Register, August, 1985, No. 356 eff. 1-1-86; r. and recr. Register, February, 1991, No. 423, eff. 4-1-91; r., Register, March, 2000, No. 531, eff. 4-1-00.

Comm 51.045 Typical examples of fire-resistive structural components. (1) Basic design and construction for specified fire-resistive protection of structural components listed in table 2, including references pars. (a) through (r), shall be acceptable.

Note: The following table is based on performance, interpretation of various test data or data from ASTM E-119 test (see table 2).

(a) *Types of concrete.* 1. Type I—normal weight concrete with lime-stone, calcareous gravel and air-cooled slag aggregate.

2. Type II—normal weight concrete with siliceous gravel, granite or quartz aggregate containing more than 40% quartz, chert or flint. Values given for type I apply except where values are tabulated for type II.

3. Type III—lightweight aggregate with expanded slag, shale or clay aggregate. Includes sanded—lightweight concretes not over 115 lbs. per cu. ft. oven-dried density.

(b) Cover on reinforcing steel is for sides and bottoms. Where tensile reinforcing elements have different cover, the tabulated cover is the average of the minimum values of the individual elements. The cover of an individual element shall not be less than $\frac{1}{2}$ the tabulated value. Top cover to be a minimum of $\frac{3}{4}$ inch.

(c) For the heat transmission requirements of floor and roof construction, the thickness of the top slab may be reduced if non-combustible insulation is directly applied to either side of the slab and provided the U-factor is equaled or reduced.

(d) The thickness of top slab is in accordance with ASTM E-119 heat transmission requirements. For variations in thickness of top slab see s. Comm 51.042 (5).

Table 2
TYPICAL EXAMPLES OF FIRE RESISTIVE STRUCTURAL COMPONENTS

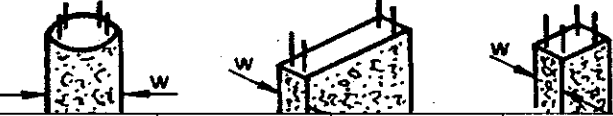
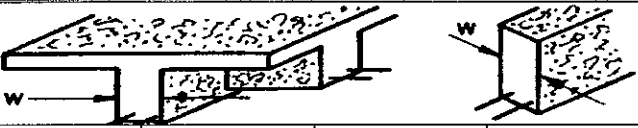

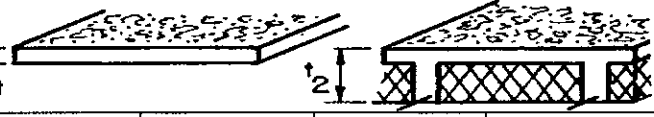

Components Without Applied Protection— CONCRETE CAST IN PLACE AND PRECAST MILD STEEL REINFORCEMENT															
Row No.	Structural Components	Insulating Material	Description	Sketch & Minimum Requirements											
1.	Columns	Concrete Type I, II & III (a) (b)													
				4 Hour			3 Hour			2 Hour			1 Hour		
				I	II	III	I	II	III	I	II	III	I	II	III
				Reinf. Cover	2	2	2	2	2	2	1½	1½	1½	1½	1½
Min. Dim. & Area—Sq. In.	12–144			10–120			8–64			6–48					
2.	Girders and Beams	Concrete Type I, II & III (a) (b) (n)													
				4 Hour			3 Hour			2 Hour			1 Hour		
				I	II	III	I	II	III	I	II	III	I	II	III
				Reinf. Cover	2	2	2	1½	1½	1½	1½	1½	1½	1	1
Width (w)	8	8	8	8	8	8	6	6	4	4	4	4			
3.	Joists and Waffles without Fillers or Partial Fillers of Masonry or Clay Tile Filler	Concrete Type I, II & III (a) (b) (c) (d) (e) (h) (n)													
				4 Hour			3 Hour			2 Hour			1 Hour		
				I	II	III	I	II	III	I	II	III	I	II	III
				Reinf. Cover	1	1	1	1	1	1	¾	¾	¾	¾	¾
Width Web (w)	6	6	6	5	5	5	4	4	4	4	4	4			
Th. Top Slab (t)	6¾	7	5½	5¾	6¾	4¾	4¾	5	3¾	3¾	3½	2¾			
4.	Slabs or Joists with Masonry or Clay Tile Filler	Concrete Type I, II & III (a) (b) (c) (d) (e) (h) (n)													
				4 Hour			3 Hour			2 Hour			1 Hour		
				I	II	III	I	II	III	I	II	III	I	II	III
				Reinf. Cover	1	1	1	1	1	1	¾	¾	¾	¾	¾
Th. Top Slab (t)	6¾	7	5½	5¾	6¾	4¾	4¾	5	3¾	3¾	3½	2¾			
5.	Walls and Partitions Bearing and Nonbearing	Concrete Type I, II & III (a) (b) (e)													
				4 Hour			3 Hour			2 Hour			1 Hour		
				I	II	III	I	II	III	I	II	III	I	II	III
				Reinf. Cover	1	1	1	1	1	1	¾	¾	¾	¾	¾
Thickness (t)	6	6½	5	5	5½	4½	4	4½	4	3	3	3			

Table 2 (continued)

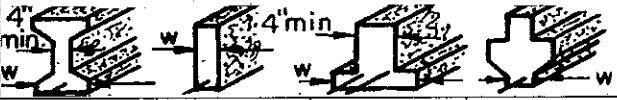
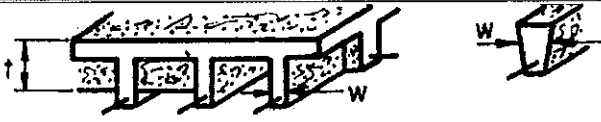
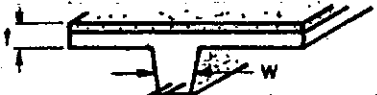
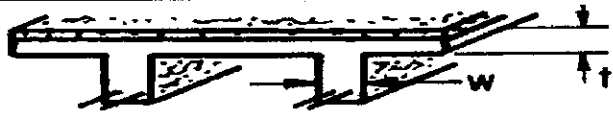
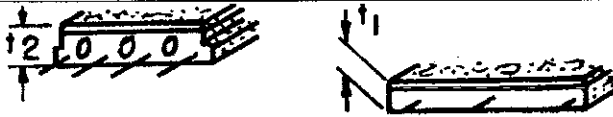
Components Without Applied Protection— CONCRETE PRECAST & CAST IN PLACE POST-TENSION OR PRE-TENSIONED SIMPLE SPAN													
Row No.	Structural Components	Insulating Material	Description	Sketch & Minimum Requirements									
6.	Girders and Beams	Concrete Type I, II & III (a) (b) (k)											
				4 Hour		3 Hour		2 Hour		1 Hour			
				I & II	III	I & II	III	I & II	III	I & II	III		
				Ave. Cover	3½	3	3	2¾	2½	2	1¾	1½	
(w)	11	10	9½	8	7	6¾	4	4					
7.	Joists and Waffles	Concrete Type I, II & III (a) (b) (c) (d) (e) (k)											
				4 Hour		3 Hour		2 Hour		1 Hour			
				I & II	III	I & II	III	I & II	III	I & II	III		
				Ave. Cover	3½	3	3	2¾	2½	2	1¾	1½	
				Ave. Web Th. (w)	11	10	9½	8	7	6¾	4	4	
Slab Th. (t)	6¾	7	5½	5¼	6	4¾	4¾	5	3¾	3¾	2¾		
8.	Single Tee	Concrete Type I, II & III (a) (b) (c) (d) (e) (k)											
				4 Hour		3 Hour		2 Hour		1 Hour			
				I & II	III	I & II	III	I & II	III	I & II	III		
				Ave. Cover	2¾	2¾	1¾	1¾	1¾	1¾	1¾	1¾	
				Ave. Web Th. (w)	8	8	8	8	8	8	4	4	
Top Thick's (t)	6¾	7	5½	5¼	6	4¾	4¾	5	3¾	3¾	2¾		
9.	Multi-Tee Units	Concrete Type I, II & III (a) (b) (c) (d) (e) (k)											
				4 Hour		3 Hour		2 Hour		1 Hour			
				I & II	III	I & II	III	I & II	III	I & II	III		
				Ave. Cover	By Test or Listing by Approved Testing Laboratory				2	1¾	1¾	1½	1½
				Ave. Web Th. (w)	By Test or Listing by Approved Testing Laboratory				4	4	4	2½	2½
Top Thick's (t)	By Test or Listing by Approved Testing Laboratory				4¾	5	3¾	3¾	3½	2¾			
10.	Solid and Cored Slabs	Concrete Type I, II & III (a) (b) (c) (d) (e) (h) (k)											
				4 Hour		3 Hour		2 Hour		1 Hour			
				I & II	III	I & II	III	I & II	III	I & II	III		
				t ₁ or t ₂	6¾	7	5½	5¼	6	4	4¾	5	3¾
Ave. Cover	2½	2½	2	1¾	1¾	1½	1	1					

Table 2 (continued)



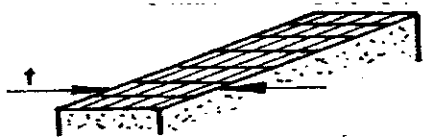
Components Without Applied Protection— MASONRY BEARING AND NONBEARING															
Row No.	Structural Components	Insulating Material	Description	Sketch & Minimum Requirements											
															
11.	Unreinforced Concrete Walls and Partitions	Concrete Type I, II & III (a) (m)		4 Hour			3 Hour			2 Hour			1 Hour		
				I	II	III	I	II	III	I	II	III	I	II	III
			Wall Th. (t)	6	6½	5	5	5½	4½	4	4½	4	3	3	3
															
12.	Hollow Masonry Walls and Partitions— Block Tile, Cored Bricks, Cavity Walls	Coarse Aggregate (g) (m)		4 Hour			3 Hour			2 Hour			1 Hour		
		Expanded Slag	Equiv. Thick's (r)	4.7			4.0			3.2			2.1		
		Expanded Clay, Shale or Slate	Equiv. Thick's (r)	5.1			4.4			3.6			2.6		
		Limestone, Cinders, Unexpanded Slag	Equiv. Thick's (r)	5.9			5.0			4.0			2.7		
		Calcareous or Siliceous Gravel	Equiv. Thick's (r)	6.2			5.3			4.2			2.8		
															
13.	Solid Masonry Brick Block— Clay Tile with Less than 25% Voics or with the Cores Filled	Masonry Clay, Shale, Concrete, Sand or Lime (m)		4 Hour			3 Hour			2 Hour			1 Hour		
			Wall Th. (t)	10"			8"			6"			4"		

Table 2 (continued)


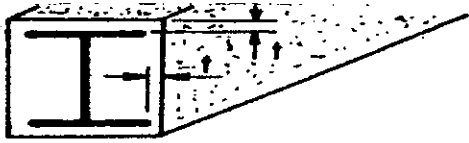

Components With Direct Applied Protection— STEEL															
Row No.	Structural Components	Insulating Material	Description	Sketch & Minimum Requirements											
															
14.	Columns			4 Hour			3 Hour			2 Hour			1 Hour		
				I	II	III	I	II	III	I	II	III	I	II	III
		Concrete Type I, II & III (a) (p)	Thickness of Protection (t)	2	2½		1½	2		1	1½		1	1	
		Solid Masonry (i)	Thickness of Protection (t)	¾	¾		¾	¾		¾	¾		¾	¾	
															
15.	Girders...Beams... Trusses			4 Hour			3 Hour			2 Hour			1 Hour		
				I	II	III	I	II	III	I	II	III	I	II	III
		Concrete Type I, II & III (a) (p)	Thickness of Protection (t)	2	2½		1½	2		1	1½		1	1	
															
16.	Columns...Beams... Girders...Trusses... Joists and Steel Floor Units	Sprayed Fiber...Cementitious Mixture...Intumescent Paints		4 Hour			3 Hour			2 Hour			1 Hour		
				By Tests...or Listing by Approved Testing Laboratory											

Table 2 (continued)

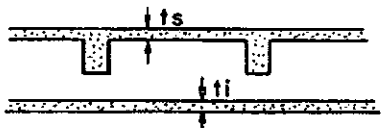
Components With Suspended or Attached Protection— CONCRETE															
Row No.	Structural Components	Insulating Material	Description	Sketch & Minimum Requirements											
															
17.	Concrete Joists or Waffle	Concrete Type I, II or III ¼" cover (a) (c) (d)	t _s Slab Thickness	4 Hour			3 Hour			2 Hour			1 Hour		
		Vermiculite...gypsum...or perlite gypsum on metal lath	t _i Insulation Thickness	3"	2"		1"	¾"							

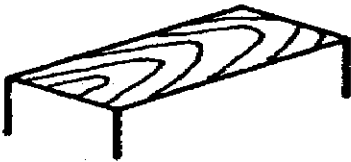

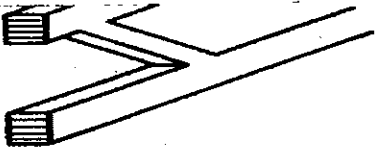
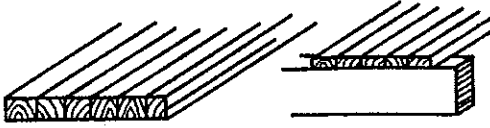
Table 2 (continued)

Components With Suspended or Attached Protection— STEEL FRAMING							
Row No.	Structural Components	Insulating Material	Description	Sketch & Minimum Requirements			
18.	Steel Columns	Type I & II Masonry 1½" air space (j)	t Insulation Thickness	4 Hour	3 Hour	2 Hour	1 Hour
				4" solid			
19.	Steel Girders...Beams...Trusses... Joists, Columns Individually Protected	Sprayed Fibre... Cementitious Mixture...Lath & Plaster		4 Hour	3 Hour	2 Hour	1 Hour
				By Tests...or Listing by Approved Testing Lab			
20.	Steel Beams, Girders, Trusses and Joists...with Ceiling Protection and Minimum 2½ Th. Type I, II or III Con- crete Slab (a) (c) (d)	Sprayed Fibre... Cementitious Mixture...Lath & Plaster Acoustical Tile		4 Hour	3 Hour	2 Hour	1 Hour
				By Tests...or Listing by Approved Testing Lab			
21.	Steel Stud Partition Nonbearing, Min. 2½" Stud	Gypsum...Perlite Plaster on Perforated Gyp. Lath	tp Plaster t1 Lath	4 Hour	3 Hour	2 Hour	1 Hour
						¾"	½"
						⅜"	⅜"
		Gypsum Wall Board (q)	No. Layers Thick, Each			Two ⅝"	One ⅝"

Table 2 (continued)

Components With Suspended or Attached Protection— COMBUSTIBLE CONSTRUCTION							
Row No.	Structural Components	Insulating Material	Description	Sketch & Minimum Requirements			
22.	Wood Joists Min. 2" x 10", Wood Floor Attached Ceiling (q)	Gypsum Wallbrd Below 2" x 10"s Max. 24" o/c	t _w Wallbrd Thickness	4 Hour	3 Hour	2 Hour	1 Hour 5/8"
		1/2" Plywood or 1" x 6" T&G Sub-Flrg	t _f Flooring				5/8" Plywood or Nom. 1" x 3" T&G
23.	Wood Joists Min. 2" x 10", Wood Floor Suspended Ceiling	Noncombustible Acoustical Tile Below 2" x 10"s 16" o/c	t _i Insulation	4 Hour	3 Hour	2 Hour	1 Hour 5/8"
		5/8" Plywood or Nom. 1" x 4" T&G Sub-Flrg	t _f Flooring				1/2" Plywood or Nom. 1" x 6" T&G
24.	Wood Stud Partition Min. 2" x 4" Stud	Gypsum Wallboard (q)	No. Layers/Th. of Each	4 Hour	3 Hour	2 Hour	1 Hour Two 3/8" or One 5/8"
		Gypsum Perlite Plaster on 3/8" Gypsum Lath	t _p			1" plas. w/1" hex. mash	9/16" plaster
		Gypsum & Sand Plaster on U.L. Listed Wire Lath	t _i				3/4" plaster
		Gypsum & Vermiculite Plaster on Metal Lath	t _i				3/4" plaster

Table 2 (continued)
Heavy Timber Construction Table

HEAVY TIMBER SOLID OR LAMINATED							
Row No.	Structural Components	Insulating Material	Description	Sketch & Minimum Requirements			
							
25.	Columns	Wood All Species		4 Hour	3 Hour	2 Hour	1 Hour
			Floor...Width x Depth Min. Nom.				8" x 8"
			Roof...Width x Depth Min. Nom.				6" x 8"
							
26.	Girders and Beams	Wood All Species		4 Hour	3 Hour	2 Hour	1 Hour
			Min. Width x Depth (Nom.)				6" x 10"
							
27.	Arch and Truss for Roof Only	Wood All Species		4 Hour	3 Hour	2 Hour	1 Hour
			Min. Width x Depth Each Member				4" x 6"
							
28.	Floor and Roof Deck	Wood All Species		4 Hour	3 Hour	2 Hour	1 Hour
			Roof				2" Nom. T&G or 3" Solid
			Floor				3" Nom. T&G + 1" Nom. T&G or 4" Solid

(e) Longitudinal joints between individual precast floor or roof units, or individual wall units shall be installed as tested or shall be grouted solid for the thickness required by the fire-resistive rating. Noncombustible insulation may be substituted for the grout if the U-factor is equaled or reduced providing the integrity of insulation remains as installed. The topping used in floor or roof units may be included.

(g) Equivalent thickness = $\frac{\text{Total volume minus volume of voids}}{\text{length times height}}$

(h) t^2 -equivalent thickness = $\frac{\text{Total volume minus volume of voids}}{\text{length times height}}$

(i) Clay, shale, concrete or sand lime—with less than 25% voids or with all spaces filled.

(j) 1 1/2 inch space between column and masonry unit—no fill required.

(k) For restrained conditions, thickness of fire protection may be reduced if substantiated by test data or calculation method.

(L) Elements with this minimum size are recognized for heavy timber construction, acceptable for certain buildings in lieu of one hour noncombustible construction.

(m) Where combustible members are framed into a wall, the wall shall be of such thickness or be so constructed that the fire barrier between the member and the opposite face of the wall, or between adjacent members set in from opposite sides will be 93% of the equivalent thickness shown in Table 2.

(n) Cover thickness on reinforcing steel as indicated is based on continuity of system. For simple span conditions increase cover thickness by 50%.

(p) Wire mesh reinforced and with a minimum area of 0.015 inches square per foot of length or equivalent.

(q) 5/8 gypsum wallboard shall be type "X" or "C".

(r) The specified hourly rating may be increased by 2 hours if the cores are filled with loose, dry expanded slag, water repellent vermiculite or burned clay or shale.

History: Cr. Register, February, 1971, No. 182, eff. 7-1-71; r. eff. 8-1-71, and rec. eff. 1-1-72, Register, July, 1971, No. 187; am. (1) (f), Register, March, 1972, No. 195, eff. 4-1-72; am. (1) (intro.) and (q), Register, December, 1981, No. 312, eff. 1-1-82; r. and rec. table 2, line 12, r. (1) (f) cr. (1) (r), Register, December, 1983, No. 336, eff. 1-1-84; am. (1) (intro.) and table 2, line 18, Register, February, 1991, No. 423, eff. 4-1-91.

Comm 51.046 Calculation method. (1) The rational design of structural members for fire resistance shall be submitted to the department and shall be based on the type of span (simple or restrained), the magnitude of longitudinal restraint, accepted structural engineering principles and methods.

(2) Appropriate research data and design criteria to substantiate the method, interpreting between known information, shall accompany the above material and shall include:

(a) Time—temperature relationship ASTM E-119;

(b) The temperature—strength characteristics of the structural components;

(c) The time—temperature characteristics of the insulating material, at the temperature range designated by ASTM E-119;

(d) The expansion characteristics of the materials comprising the member, at the temperature range designated by ASTM E-119; and

Note: For ASTM E-119 standard adopted see s. Comm 51.25 (4) Table 51.25-10. The department will accept published research data from the Portland Cement Association, the American Iron & Steel Institute, and the American Institute of Steel Construction, Inc.

(e) The safety factor of not less than 1.0 shall be maintained at the end of the time requirement for the full design live load and dead load.

History: Cr. Register, February, 1971, No. 182, eff. 7-1-71; r. eff. 8-1-71, and rec. eff. 1-1-72, Register, July, 1971, No. 187; rem. (1) (a) (intro.) and 1. to 5. to be (2) (intro.) and (a) to (e) and am. Register, January, 1994, No. 457, eff. 2-1-94.

Comm 51.047 Fire-rated door assemblies in fire-rated construction. (1) GENERAL. (a) Except as provided in pars. (b) and (c) and ss. Comm 51.048 and 51.049, an opening,

where permitted in a fire-resistive rated assembly, shall be protected by means of a fire-resistive rated door assembly installed and maintained in accordance with NFPA 80.

(b) Where a fire-resistive wall assembly is used only as an interior bearing wall as specified in line 17 of Table 51.03-A, and is not also used for separation purposes, the opening does not require protection with a fire-resistive rated door assembly, provided all parts of the opening maintain the fire-resistive rating of the wall assembly.

(c) Openings in fire-resistive rated assemblies to accommodate conveyor systems shall be protected with one of the following: 1. A fire-resistive rated door assembly installed and maintained in accordance with NFPA 80.

2. A water spray system installed in accordance with NFPA 15 and all of the following:

a. Initiating devices shall be installed on both sides of the penetrated assembly.

b. Nozzles shall protect the entire opening on both sides of the assembly.

c. The conveyor shall be constructed such that it stops running when the spray system is activated.

d. The minimum design density of the water spray shall be 0.50 gallons per minute per square foot of protected opening.

e. The minimum water supply duration shall be 120 minutes.

(2) The fire-resistive rated door assembly shall be tested in accordance with NFPA 252 or UL 10B and listed and labeled as having the fire-resistive rating required by Table 51.047.

**TABLE 51.047
MINIMUM FIRE-RESISTIVE RATINGS OF DOOR ASSEMBLIES**

Fire-Resistive Rating of a Wall or Wall Assembly	Fire-Resistive Rating of Door Assembly
4-hour	3-hour A
3-hour	3-hour A
2-hour	1 1/2-hour B
1-hour	3/4-hour C

The letter A, B or C following the hourly rating designates the location for which the assembly is designed, which is intended to agree with NFPA Standard 80. Compliance with the hourly rating is required regardless of the letter designation.

(3) LABELS. Fire-rated door assemblies shall be labeled with a permanent label, securely attached and located to permit visual inspection after installation. The label shall identify the time rating, testing laboratory, listing agency and manufacturer.

(a) Labeled fire-door assemblies shall not be modified without written acceptance from the testing laboratory.

(4) SECURING DOOR FRAMES. Methods of securing door frames to adjacent construction shall be illustrated on the plans submitted to the department for review.

(5) DOOR CLOSING DEVICES. All labeled fire doors, where required, shall be equipped with an approved automatic or self-closing device as defined in s. Comm 51.01 (17). A fusible link may not be used to activate an automatic closing device.

(a) All doors serving smokeproof towers or interior enclosed stairways shall be equipped with a self-closing device or an automatic closing device actuated by products of combustion other than heat.

(b) The requirements of par. (a) shall also be retroactive to existing buildings.

(c) Doors provided with a self-closing device shall remain in a closed position.

Note: The intent of this rule is to accept normal usage of the door, but not permit doors with this closing device to be blocked open at any time.

(d) Where a pilot weight is used, it shall be suspended from a chain or wire cable, and shall be installed in a protective housing.

Note: For specific types of closing devices permitted, please refer to the sections dealing with classes of construction and/or the occupancy chapters.

History: Cr. Register, February, 1971, No. 182, eff. 7-1-71; r. eff. 8-1-71 and rec. eff. 1-1-72, Register, July, 1971, No. 187; am. (1) (intro.), r. and rec. (1) (a) 1., Register, September, 1973, No. 213, eff. 10-1-73; cr. (1) (a) 1. c., Register, December, 1974, No. 228, eff. 1-1-75; r. and rec., Register, December, 1975, No. 240, eff. 1-1-76; r. and rec. (6), Register, December, 1976, No. 252, eff. 1-1-77; cr. (2) (a), Register, January, 1980, No. 289, eff. 2-1-80; am. (1), Register, December, 1981, No. 312, eff. 1-1-82; am. (6) (a), Register, December, 1983, No. 336, eff. 1-1-84; r. and rec. (1), Register, March, 1991, No. 423, eff. 4-1-91; am. (1) (a) 2. and Table, Register, January, 1994, No. 457, eff. 2-1-94; am. (1) (a) 1., cr. (1) (a) 3., Register, September, 1998, No. 513, eff. 10-1-98; r. and rec. (1), r. (3) and (5), renum. (2) to be (3) and (6) to be (5), cr. (2) and am. (5), Register, March, 2000, No. 531, eff. 4-1-00.

Comm 51.048 Fire window and glass block assemblies in fire-rated construction. (1) WINDOW OPENINGS. (a) Except as allowed under par. (b), window openings, where permitted in fire-resistive rated assemblies, shall be protected with fire window or glass block assemblies installed and maintained in accordance with NFPA 80 and rated as 3/4-hour when tested in accordance with NFPA 257 or UL 9 by an approved laboratory.

(b) Where a fire-resistive wall assembly is used only as an interior bearing wall as specified in line 17 of Table 51.03-A, and is not also used for separation purposes, the opening does not require protection with a fire-resistive window assembly, provided all parts of the opening maintain the fire-resistive rating of the wall assembly.

(c) Windows are not permitted in fire-resistive rated assemblies required to have a fire-resistive rating greater than one hour unless specifically permitted elsewhere in this code.

(2) SIZE. (a) *Fire window assemblies.* The sizes and dimensions of the glazing materials and the frames may not exceed their respective listing. Windows combined in multiple assemblies shall be separated by approved nonbearing metal mullions.

(b) *Glass block assemblies.* Openings for glass block assemblies shall not exceed 120 square feet in area. The width or height of the opening shall not exceed 12 feet.

(3) MATERIALS AND INSTALLATION. (a) *Frames.* Approved metal frames shall be securely fastened to the construction and be capable of resisting all wind stresses and other stresses to which they are likely to be subjected.

(b) *Wired glass.* The wired glass shall be labeled wired glass, 1/4-inch thick, and shall be well bedded in approved glazing compound. All exposed joints between the metal shall be struck and pointed. The clearance between the edges of the glass and metal framing shall not exceed 1/8 inch.

(c) *Glass block.* Glass block assemblies shall be installed according to the details of the tested assembly.

Note: The department will accept recommended practices for installation covered in "Standard for Fire Doors and Windows," NFPA No. 80.

(d) *Approved glass.* Glass for a fire window application shall conform to the conditions and limitations of its listing.

(4) LABELS. Fire window assemblies shall be labeled with a permanent label, securely attached and located to permit visual inspection after installation. The label shall identify the time rating, testing laboratory, listing agency and manufacturer. Glass block shall be listed by an approved laboratory.

History: Cr. Register, December, 1975, No. 240, eff. 1-1-76; r. and rec. (2) (a), cr. (3) (d), Register, March, 1991, No. 423, eff. 4-1-91; am. (1), Register, January, 1994, No. 457, eff. 2-1-94; renum. (1) to be (1) (a) and am., cr. (1) (b), Register, September, 1998, No. 513, eff. 10-1-98; am. (1) (a), r. and rec. (1) (b) and cr. (1) (c), Register, March, 2000, No. 531, eff. 4-1-00.

Comm 51.0485 Fire dampers, smoke dampers and ceiling dampers. (1) Except as provided under sub. (2), ducts that terminate at or pierce a code-required, fire-resistive rated assembly shall be protected with a listed fire damper, smoke damper or ceiling damper installed and maintained in accordance with the requirements of NFPA 90A.

(2) Kitchen exhaust ducts serving a hood may not have a damper installed, except under one of the following conditions:

(a) The damper is listed for such use or is part of a listed device or system.

(b) A carbon dioxide extinguishing system is installed.

Note: See s. Comm 64.67 (6) (g) for requirements on carbon dioxide extinguishing systems, in addition to the requirements of NFPA 12.

Note: See s. Comm 64.67 (5) (f) for duct enclosure requirements.

History: Cr. Register, March, 2000, No. 531, eff. 4-1-00.

Comm 51.049 Miscellaneous penetrations in fire-resistive construction. (1) GENERAL. (a) Except as specified in pars. (c) and (d), penetrations into or through fire-resistive assemblies, fire protective membranes, thermal barriers, or construction providing a finish rating as an alternative to a fire resistive assembly shall be protected in accordance with this section.

(b) Where an approved fire-stop system is used, the system shall be tested and listed for the specific application regarding the size of the opening, the size and type of the penetrating objects, the type of assembly penetrated, and the size of the annular space to be fire stopped.

(c) Where tested and listed fire resistive assemblies under s. Comm 51.044 are being used and the listing provisions regarding membrane penetrations are in conflict with this section, the provisions of the tested and listed assembly shall govern.

(d) Where the fire-resistive assembly is being used to provide only the protection required as a structural building element, as specified in lines 1 through 17, 21 and 22 of Table 51.03-A, is not also used for separation purposes and is a through penetration, the opening need not be protected in accordance with par. (a) if the opening is effectively fire stopped to ensure that the fire-resistive integrity of the structural element will not be reduced.

(2) DUCT OPENINGS. The annular space around the outside of a duct that penetrates into or through fire-resistive construction, as described in sub. (1) (a), shall be protected in accordance with one of the following:

(a) The recommendations of the manufacturer of the fire damper or the fire curtain door, when the duct is provided with a fire damper or fire curtain door at the penetration.

(b) An approved fire-stop system having an F-rating not less than the hourly rating of the assembly being penetrated.

(c) Grout, concrete or mortar for the full depth of the penetrated assembly when the assembly is constructed of concrete or masonry.

Note: See s. Comm 51.0485 for fire damper and fire curtain door requirements.

(3) NONCOMBUSTIBLE PENETRATING ITEMS. (a) *Through-penetrations.* Through-penetrations of fire-resistive assemblies by noncombustible wiring items or noncombustible piping items, excluding glass piping, shall be in accordance with this subsection.

(b) *Openings of 100 square inches or less.* Where the area of an opening is 100 square inches or less and the total aggregate area of all such openings does not exceed 100 square inches in any 100 square feet of surface area being penetrated, the annular space around the penetrating item shall be protected in accordance with one of the following:

1. Closed with an approved fire-stop system having an F-rating not less than the hourly rating of the assembly being penetrated.

2. Filled to the full depth of the penetrated assembly with grout, concrete, or mortar, when the assembly is constructed of concrete or masonry.

(c) *Openings larger than 100 square inches.* 1. Wall assemblies. Where a wall assembly opening is larger than 100 square inches or the total aggregate area of all such openings exceeds 100 square inches in any 100 square feet of wall surface area, the annular space around the penetrating item shall be closed with an approved fire-stop system having an F-rating not less than the hourly rating of the assembly being penetrated.

2. Floor assemblies. Where a floor assembly opening is larger than 100 square inches or the total aggregate area of all such openings exceeds 100 square inches in any 100 square feet of surface

area and the openings are not contained within a wall or column at the point the floor is penetrated, the annular space around the penetrating item shall be closed with an approved fire-stop system having an F-rating not less than the hourly rating of the assembly being penetrated.

(4) **COMBUSTIBLE PENETRATING ITEMS.** Through-penetrations of fire-resistive assemblies by combustible piping items, glass piping, or combustible wiring items shall be protected with an approved fire-stop system having an F-rating not less than the hourly rating of the assembly being penetrated.

(5) **MEMBRANE PENETRATIONS.** (a) *Openings around objects.*
1. Except as provided in subs. 2. to 4., the annular space of a membrane penetration into a fire-resistive assembly, or through a fire-protective membrane, a thermal barrier, or construction providing a finish rating as an alternative to a fire resistive assembly, shall be protected in the same manner as that provided for the membrane of a through-penetration of a similar assembly under sub. (2), (3), or (4).

2. The annular space of a membrane penetration that occurs around electrical outlet and switch boxes that are listed by an approved testing laboratory as either "outlet boxes and fittings classified for fire resistance" or "metallic outlet boxes" is not required to be protected in accordance with subd. 1., if the width of the space is 1/8 inch or less.

3. The annular space of a membrane penetration that occurs around a fire sprinkler and which is provided with a metal escutcheon plate is not required to be protected in accordance with subd. 1.

4. Membrane penetrations by electrical outlet and switch boxes that are listed by an approved testing laboratory as "outlet boxes and fittings classified for fire resistance" shall be used subject to the requirements and limitations of the listing.

(b) *Metallic outlet boxes.* The membrane penetration of vertical fire-resistive construction having a rating of 2 hours or less, including a fire-resistive wall assembly, a fire-protective membrane, a thermal barrier, or construction providing a finish rating as an alternative to a fire resistive assembly, that is created by electrical outlet and switch boxes that are listed by an approved testing laboratory as "metallic outlet boxes," shall be subject to all of the following:

1. The surface area of an individual box may not exceed 16 square inches.

2. The aggregate surface area of the boxes may not exceed 100 square inches per 100 square feet of wall surface.

3. Boxes shall not be installed on opposite sides of walls or partitions of staggered stud construction unless tested and listed for use in staggered stud construction by an approved testing laboratory.

4. Where boxes are located on opposite sides of a non-staggered stud wall or partition, the boxes shall be separated by a minimum horizontal distance of 24 inches, unless installed in accordance with one of the following:

a. The boxes shall be protected with a listed wall opening protective material installed in accordance with the listing.

b. The boxes shall be separated by solid fire blocking in accordance with s. Comm 51.02 (24).

(6) **CONSTRUCTION JOINTS.** (a) *General.* Except as allowed under par. (b), all joints between adjacent fire-resistive rated assemblies, such as between floor and wall assemblies, shall be designed and installed to maintain the hourly rating of the assembly.

(b) *Exceptions.* Fire-resistive construction joint systems are not required for joints in the following locations:

1. Floors within a single dwelling unit.

2. Floors where the joint is protected with a fire-resistive shaft enclosure in accordance with s. Comm 51.02 (11) (a).

3. Floors within atriums where the adjacent space is included in the volume of the atrium for smoke control purposes.

4. Floors within malls.

5. Floors within open parking structures.

6. Mezzanine floors.

7. Walls that are permitted to have unprotected openings.

8. Roofs where openings are permitted.

9. Control joints tested in accordance with ASTM E 119 that have a maximum joint width of 5/8 inch.

10. Joints that were tested as an integral part of the fire-resistive rated assembly.

(c) *Classification and testing.* 1. Except as allowed under subd. 2., construction joints under par. (a) shall be classified by an independent testing laboratory based on testing in accordance with UL 2079.

2. Voids at the intersection of fire-resistive rated assemblies and exterior curtain walls shall be protected with materials tested in accordance with ASTM E 119.

History: Cr. Register, December, 1975, No. 240, eff. 1-1-76; cr. (3), Register, January, 1980, No. 289, eff. 2-1-80; am. (3) (intro.), Register, December, 1981, No. 312, eff. 1-1-82; am. (1), (3) (c) and (d), Register, March, 1991, No. 423, eff. 4-1-91; am. (3) (intro.) and (b), Register, January, 1994, No. 457, eff. 2-1-94; r. and recr., Register, September, 1998, No. 513, eff. 10-1-98; am. (5) (b) 4. (intro.), r. and recr. (5) (b) 4. a. and b. and cr. (6), Register, March, 2000, No. 531, eff. 4-1-00.

Comm 51.05 Roof coverings. Roof coverings of class A, B, C or unclassified shall be provided as specified under "Classes of Construction" s. Comm 51.03 (1) to (8) or under the specific occupancy requirements of chs. Comm 54 to 62.

Note: Brick, concrete, tile, slate, and ferrous, cupreous and other metals and their alloys will be accepted as "Class A" roof coverings.

History: Cr. Register, February, 1971, No. 182, eff. 7-1-71; r. eff. 8-1-71, and recr. eff. 1-1-72, Register, July, 1971, No. 187; renum. from 51.048 to be 51.050, Register, December, 1975, No. 240, eff. 1-1-76; am. Register, January, 1994, No. 457, eff. 2-1-94.

Comm 51.06 Foam plastics. (1) **SCOPE.** The requirements of this section shall apply to the use of foam plastics in building construction.

(2) **FLAME SPREAD AND SMOKE DEVELOPED CRITERIA.** Except as otherwise provided, all foam plastic and foam plastic cores in manufactured assemblies used in building construction, shall have a flame spread rating of not more than 75 and a smoke developed rating of not more than 450 when tested in the maximum thickness intended for use in accordance with ASTM E84.

(3) **THERMAL BARRIER.** (a) Except as provided in subs. (4) to (7), foam plastics shall be separated from the interior of a building by an approved thermal barrier of 1/2 inch gypsum wallboard or equivalent thermal barrier material which will limit the average temperature rise of its unexposed surface to not more than 250°F. after 15 minutes of fire exposure as specified in the ASTM E119 standard time temperature curve or the equivalent using the Small Scale Horizontal Exposure Furnace, with samples for the test having a minimum length and width of 3 feet by 3 feet.

(b) The thermal barrier shall be installed in such a manner that it will remain in place for at least 15 minutes based upon approved diversified tests.

(4) **EXTERIOR APPLICATIONS.** The following requirements shall apply to all exterior uses of foam plastics unless specifically approved as specified in sub. (7):

(a) *Masonry or concrete components.* Foam plastics may be used without the thermal barrier specified in sub. (3) regardless of the class of construction, when the foam plastic is protected by a minimum of one inch thickness of masonry or concrete in a wall or floor system;

(b) *Noncombustible hourly rated and combustible hourly rated construction.* Foam plastics may be used within the cavity or as an element of a noncombustible hourly rated or combustible hourly rated system or assembly provided:

1. The system or assembly meets the requirements of s. Comm 51.04 for time-rated construction;

2. a. Except as provided in subd. 2. b., a thermal barrier as specified in sub. (3) is provided;

b. The thermal barrier may be omitted for exterior walls provided that the foam plastic insulation does not exceed 4 inches in thickness, has a flame spread rating of 25 or less, and is covered by a thickness of not less than 0.032 inch aluminum or corrosion-resistant sheet steel having a base metal thickness of 0.016 inches and the wall height does not exceed 50 feet and the entire building or that portion of the building closed by the walls is protected with an automatic fire sprinkler system; and

3. a. Except as provided in subd. 3., the exterior side of the assembly or system is covered with a cladding material meeting the requirements for noncombustible construction, and the wall assembly shall not propagate flame over the surface or through the core when subjected to a full scale test with the assembly in its end use condition or when subjected to an approved diversified test;

b. The exterior coating, facing or cladding material for walls may be of other than noncombustible material provided that the foam plastic core, coating, facing and cladding, each when tested individually shall have a flame spread of 25 or less and a smoke developed rating of 450 or less when tested in accordance with ASTM E84; facing, coating, cladding and core material shall be fastened to each other to prohibit failure in bond as a result of temperature which may be experienced in a building fire, or from winds or other conditions; and the wall assembly shall not propagate flame over the surface or through the core when subjected to a full scale test with the assembly in its end use condition or when subjected to an approved diversified test.

(c) *Noncombustible 0-hour (NC-0) rated construction.* Foam plastics may be used within the cavity or as an element of noncombustible 0-hour (NC-0) rated construction provided the following conditions are satisfied:

1. The foam plastic core material has a flame spread of 25 or less and a smoke developed rating of 450 or less when tested in accordance with ASTM E84;

2. a. Except as provided in subd. 2. b., a thermal barrier as specified in sub. (3) is provided;

b. The thermal barrier may be omitted for exterior walls provided that the foam plastic insulation does not exceed 4 inches in thickness, and is covered by a thickness of not less than 0.032 inch aluminum or corrosion-resistant sheet steel having a base metal thickness of 0.016 inches and the wall height does not exceed 50 feet and the entire building or that portion of the building enclosed by the walls is protected with an automatic fire sprinkler system; and

3. a. The exterior side of the assembly or system is covered with a cladding material meeting the requirements for noncombustible construction as specified in s. Comm 51.01 (86);

b. The exterior coating, facing or cladding material for walls may be of other than noncombustible material provided that the coating, facing and cladding, shall have a flame spread of 25 or less and a smoke developed rating of 450 or less when tested in accordance with ASTM E84;

c. The facing, coating, cladding and core material shall be fastened to each other to prohibit failure in bond as a result of temperature which may be experienced in a building fire, or from winds or other conditions; and

d. The wall assembly shall not propagate flame over the surface or through the core when subjected to a full scale test with the assembly in its end use condition or when subjected to an approved diversified test.

Note: Light-transmitting plastic veneer or combustible veneer materials conforming to the requirements of this paragraph need not meet the height and area limitations for light-transmitting plastics (see s. Comm 51.065).

(d) *Combustible nonrated construction.* Foam plastic insulation may be used within the cavity or as an element of combustible

nonrated construction (0) provided the following conditions are satisfied:

1. The distance to a property line or other building on the same property meets the requirements of Table 51.03-A;

2. Thermal barriers as specified in sub. (3) are provided; and

3. The exterior side of the assembly or system is covered with a cladding material meeting the requirements for combustible construction as specified in Table 51.03-A.

(e) *Roofing.* Foam plastic may be used as part of a class A, B or C or unclassified roof covering as specified in s. Comm 51.05. The foam plastic:

1. Shall not be limited as to smoke development rating;

2. May not be limited as to flame spread rating if it is a component of a factory-made composite insulation or assembly and the roof system complies with the calorimeter requirements of FM 4450 or UL 1256;

3. May be installed without a protective thermal barrier if the foam plastic has a flame spread rating of 75 or less when tested at the maximum thickness intended for use and the roof system complies with the calorimeter requirements of FM 4450 or UL 1256; and

4. May be installed without a protective thermal barrier if the foam plastic has a flame spread rating of 75 or less when tested at the maximum thickness intended for use and the foam plastic is separated from the building interior by a minimum of one inch thickness of masonry or concrete or a minimum of 1/2 inch thickness plywood bonded with exterior glue and properly edge supported, or equivalent.

(5) *OTHER APPLICATIONS.* (a) *Interior construction.* Foam plastic may be used as an element of or attached to interior construction components, including walls, partitions, floor/ceiling assemblies and similar components that divide interior spaces within the building, as follows:

1. Within the cavity or as an element of a noncombustible hourly rated or combustible hourly rated system or assembly provided the system or assembly meets the requirements of s. Comm 51.04 for time-rated construction for at least one hour with a fire exposure on both sides of the system or assembly; or

2. Within the cavity or as an element of noncombustible 0-hour (NC-0) rated construction or combustible nonrated construction (0) provided the foam plastic is protected on both sides by a thermal barrier as specified in sub. (3).

(b) *Attics and crawl spaces.* 1. Attics may be insulated with unprotected foam plastic provided the ceiling between the attic and the occupied space is covered by 1/2 inch gypsum wallboard or equivalent and the attic space is not used for storage or air handling purposes.

2. Crawl space walls may be insulated with unprotected foam plastic provided the floor between the crawl space and the occupied space consists of at least 3/4 inch tongue and groove plywood sheathing or equivalent, and the crawl space is not used for storage or air handling purposes.

3. Foam plastic shall be protected by a thermal barrier as specified in sub. (3) when the foam plastic is installed in an attic or crawl space and the area is used for storage or air handling purposes.

(c) *Doors and shutters.* 1. a. Except as provided in subd. 1. b., where doors and shutters are permitted without a fire-resistive rating, foam plastic having a flame spread rating of 75 or less may be used as a core material when the facing is metal having a minimum thickness of 0.032 inch aluminum or sheet steel having a minimum thickness of 0.0160 inch.

b. Foam plastic core sectional overhead doors covered by at least 1/8 inch thick hardboard may be used wherever nonrated combustible doors are permitted.

2. A thermal barrier is not required for doors and shutters meeting the requirements specified in subd. 1.

(d) *Siding backer board.* Foam plastic not more than 1/2 inch thick may be used as siding backer board provided it is separated from the interior of the building by not less than 2 inches of mineral fiber insulation or equivalent in lieu of the thermal barrier or when applied as insulation when residing over existing wall construction.

(e) *Decorative trim.* Foam plastic used as decorative trim shall conform with the provisions of s. Comm 51.07.

(f) *Protection from ultraviolet light.* Foam plastic insulation installed on the exterior of buildings above grade shall be permanently covered or protected to prevent degradation caused by exposure to ultraviolet light.

(6) **SPECIFIC APPLICATIONS.** (a) *Refrigerated facilities.* 1. Except as provided in subd. 2., foam plastic installed and meeting the requirements of sub. (2) when tested in a thickness of 4 inches may be used in thicknesses up to 10 inches in cold storage rooms, refrigerated food processing rooms, ice plants and similar areas. The foam plastic for refrigerated rooms within a building shall be protected on both sides by a thermal barrier as specified in sub. (3).

2. Except as provided in subd. 3., foam plastic insulation may be used without the thermal barrier when the foam plastic has a flame spread rating of 25 or less when tested as specified in subd. 1., is covered by not less than 0.032 inch of aluminum or corrosion-resistant steel having a base metal thickness not less than 0.016 inch at any point and is protected by an automatic fire sprinkler system. When a cooler or freezer module is located within a building, both the cooler or freezer module and that part of the building in which the module is located shall be protected by an automatic fire sprinkler system.

3. Foam plastics may be used in a thickness up to 4 inches in freestanding coolers or freezers having an aggregate floor area less than 400 square feet without a thermal barrier and without an automatic fire sprinkler system.

(b) *Bulk vegetable storage.* Buildings used exclusively for the bulk storage of vegetables shall have the foam plastic insulation protected on the occupied side by 5/8 inch exterior grade plywood, or equivalent.

(7) **SPECIFIC MATERIALS APPROVAL.** Foam plastic not meeting the requirements of this section may be approved by the department for specific application based on the submittal and written acceptance of data from approved diversified tests.

Note: See ss. Comm 52.01 to 52.013 for additional rules pertaining to automatic fire sprinkler systems.

Note: See s. Comm 50.19 for additional information pertaining to product approval.

History: Cr. Register, May, 1979, No. 281, eff. 6-1-79; cr. (3) (b) 8. a., Register, May, 1980, No. 293, eff. 6-1-80; cr. (3) (b) 11., Register, December, 1981, No. 312, eff. 1-1-82; r. and recr. Register, December, 1983, No. 336, eff. 1-1-84; am. (2), (3) (a), (4) (b) 3. b., (4) (c) 1. and 3. b. and (4) (e) 2. and 3., Register, August, 1985, No. 356, eff. 1-1-86; am. (4) (b) 1. and (6) (a) 3. b., Register, March, 1991, No. 423, eff. 4-1-91; am. (4) (e) 2. and 3. and (5) (b) 3., Register, January, 1994, No. 457, eff. 2-1-94; am. (6) (a) 3. b., Register, February, 1999, No. 518, eff. 3-1-99; renum. and am. (6) (a) 3. a. to be (6) (a) 3. and r. (6) (a) 3. b., Register, March, 2000, No. 531, eff. 4-1-00.

Comm 51.065 Light-transmitting plastics.

(1) **SCOPE.** (a) The requirements of this section shall apply to the quality and methods of application of plastics for use as light-transmitting materials in buildings and structures. When used as interior finish, plastic materials shall meet the requirements of s. Comm 51.07.

(b) Light-transmitting plastic shall meet one of the following combustibility classifications:

1. Classification CC 1 for plastic materials that have a burning rate of one inch per minute or less when tested in a nominal 0.060-inch thickness or in the thickness intended for use, in accordance with ASTM D 635.

2. Classification CC 2 for plastic materials that have a burning rate of 2.5 inches per minute or less when tested in a nominal 0.060-inch thickness or in the thickness intended for use, in accordance with ASTM D 635.

(c) Each unit or package of light-transmitting plastic shall be identified with a mark or decal satisfactory to the department that includes identification as to the material classification.

(2) **DEFINITIONS.** For the purpose of this section, the following definitions shall apply.

(a) "Approved light-transmitting plastic" means a single layer or multilayered composite consisting of thermoplastic, thermosetting or reinforced plastic material which has a self-ignition temperature [of] 650° F or greater when tested in accordance with ASTM D 1929, a smoke density rating no greater than 450 when tested in accordance with ASTM E 84 in the way intended for use, or a smoke density rating no greater than 75 when tested in the thickness intended for use by ASTM D 2843. Multilayered composite material shall comply as a composite in the configuration intended for use.

(b) "Glass fiber reinforced plastic" means plastic reinforced with glass fiber having not less than 20% of glass fibers by weight.

(c) "Interior secondary glazing system" means construction consisting of a glazed panel of approved light-transmitting plastic positioned on the interior side of a primary window set in an exterior wall which is designed primarily to control energy losses through exterior windows or glazed panels and is not intended for use as primary or exterior windows.

(d) "Light diffusing system" means a suspended construction consisting in whole or in part of lenses, panels, grids or baffles suspended below independently mounted electrical lighting sources.

(e) "Plastic glazing" means single glazing plastic materials which are glazed or set in a frame or sash and not held by mechanical fasteners which pass through the glazing material.

(f) "Plastic roof panels" means single glazing plastic materials which are fastened to structural members or to structural panels or sheathing and which are used as light-transmitting media in the plane of the roof.

(g) "Plastic wall panels" means single glazing plastic materials which are fastened to structural members or to structural panels or sheathing and which are used as light-transmitting media in exterior walls.

(h) "Thermoplastic material" means a plastic material which is capable of being repeatedly softened by increase of temperature and hardened by decrease of temperature.

(i) "Thermosetting material" means a plastic material which is capable of being changed into a substantially non-reformable product when cured.

(3) **GLAZING OF UNPROTECTED OPENINGS.** (a) *General.* Doors, sash and openings which are not required to be protected with fire window or glass block assemblies may be glazed with approved light-transmitting plastic in the following occupancies:

Note: See Table 51.03-B for additional requirements pertaining to windows and wall openings.

1. Schools and Other Places of Instruction under ch. Comm 56;

2. Residential Occupancies under ch. Comm 57; and

3. All other occupancies under chs. Comm 54, 55, 58, 59, 60, 61 and 62, subject to the following requirements:

a. Except as provided in par. (b), the area of such light-transmitting plastic glazing may not exceed 25% of the wall face of the story in which it is installed;

b. Except as provided in par. (b) 2., the area of a pane of light-transmitting plastic glazing installed above the first story shall not exceed 16 square feet where the vertical dimension of a pane may not exceed 4 feet and there shall be a spandrel constructed of materials meeting the requirements for exterior walls of s. Comm 51.03 and Table 51.03-A for the class of construction utilized between stories measuring a minimum of 3 feet in the vertical dimension;

c. Except as provided in par. (b) 2., approved light-transmitting plastics shall not be installed more than 75 feet above grade level;

d. Combinations of light-transmitting plastic glazing and light-transmitting plastic wall panels shall be subject to the area, height and percentage limitations and separation requirements applicable to the class of plastics as specified in sub. (4).

(b) *Exceptions.* 1. Approved light-transmitting plastic glazing may be installed in areas up to 50% of the wall area of each story in structures less than 75 feet in height which are provided on each floor above the first floor with fire canopies projecting at least 3 feet from the surface of the wall and extending at least 3 feet horizontally beyond the edge of the opening above, or equivalent. The size and dimension requirements specified in par. (a) 3. b. shall not apply.

2. Where an approved automatic fire sprinkler system is provided, the permissible area of light-transmitting plastic glazing permitted by par. (a) 3. a. may be increased to a maximum of 50% of the wall face of the story in which the glazing is installed and shall be exempt from the requirements specified in par. (a) 3. b. and c.

(4) **EXTERIOR WALL PANELS.** (a) *General.* Subject to requirements specified in par. (b), approved light-transmitting plastics may be used as wall panels in exterior walls not requiring a fire-resistive rating in all occupancies except the following:

1. Theaters and Assembly Halls under ch. Comm 55;
2. Health Care, Correctional and Detention Facilities under ch. Comm 58; and
3. All high hazard occupancies.

(b) *Area and separation limitations.* 1. Except as provided in par. (c), area limitation and separation requirements of exterior light-transmitting plastic wall panels shall be as specified in Table 51.065-1.

2. Vertical spandrel wall separation constructed of materials meeting the requirements for exterior walls of s. Comm 51.03 and Table 51.03-A for the class of construction utilized between stories shall be:

- a. Three feet for CC 1 plastic wall panels; or
- b. Four feet for CC 2 plastic wall panels.

TABLE 51.065-1
AREA LIMITATION AND SEPARATION REQUIREMENTS FOR LIGHT-TRANSMITTING PLASTIC WALL PANELS*

Set-Back Distance to Property Line or Other Walls on Same Property	Class of Plastic	Maximum % Area of Exterior Walls in Plastic Panels	Maximum Single Area (Square Feet)	Minimum Separation of Panels (Feet)	
				Vertical	Horizontal
5 feet or less	—	NP	NP	—	—
5 feet or more	CC 1	10	50	8	4
but less than 10 feet	CC 2	NP	NP	—	—
10 feet or more	CC 1	25	90	6	4
but less than 30 feet	CC 2	15	70	8	4
Over 30 feet	CC 1	50	Not limited	3	0
	CC 2	25	100	6	3

NP means not permitted

*The requirements of this Table do not apply to greenhouses. See ch. Comm 62, subch. VI.

(c) *Exceptions.* 1. In structures which are provided on any floor above the first with continuous horizontal projections extending at least 36 inches from the surface of the wall in which light-transmitting plastic wall panels are installed, there need be no vertical separation at that floor except that provided by the vertical thickness of the projection.

2. Where an approved automatic fire sprinkler system is provided in the building, the maximum percent area of light-transmitting plastic panels in the exterior wall and the maximum square feet of single area given in Table 51.065-1 may be increased 100% but in no case may the area of light-transmitting plastic wall panels exceed 50% of the wall area.

(5) **ROOF PANELS.** (a) *General.* Except in chs. Comm 55 and Comm 58 occupancies and high hazard occupancies, approved light-transmitting plastic roof panels may be installed as follows, subject to the requirements specified in par. (b):

1. In roofs of buildings protected by an approved automatic fire sprinkler system;

2. Where the roof is not required to have a fire resistance rating; or

3. Where the light-transmitting plastic roof panels meet the requirements for roof coverings of the appropriate class of construction.

Note: See s. A52.011 for additional information regarding high hazard occupancies.

(b) *Limitations.* Except as provided in par. (c), the use of light-transmitting plastic roof panels shall be limited as follows:

1. Individual light-transmitting plastic roof panels or units shall be separated from each other by a distance of not less than 4 feet measured in a horizontal plane.

2. Where exterior wall openings are required to be protected, no light-transmitting plastic roof panels or units may be installed within 8 feet of such exterior wall.

3. Light-transmitting plastic roof panels or units shall be limited in area and the aggregate area of panels shall be limited by a percentage of the floor area of the room or space sheltered in accordance with Table 51.065-2.

TABLE 51.065-2*
AREA LIMITATIONS FOR LIGHT-TRANSMITTING PLASTIC ROOF PANELS AND SKYLIGHTS

Class of Plastic	Maximum Area Individual Unit or Panel (sq. ft.)	Maximum Aggregate Area (% of Floor Area)
CC 1	300	33 1/3
CC 2	100	25

*The requirements of this table do not apply to greenhouses. See ch. Comm 62, subch. VI.

(c) *Exceptions.* 1. One-story buildings not more than 16 feet in height and not exceeding 1200 square feet in area and not closer than 10 feet to another building are exempt from the limitations specified in par. (b). — *Shall meet CC 1 or 2.*

2. Low-hazard use areas such as swimming pool shelters and similar structures, are exempt from the area limitations specified in par. (b) provided they do not exceed 5,000 square feet in projected floor area and are not closer than 10 feet to the property line or adjacent buildings.

Note: See s. A52.011 for additional information regarding low hazard occupancies.

(6) SKYLIGHTS. (a) *General.* Subject to the requirements of par. (b), skylight assemblies may be glazed with approved light-transmitting plastic in all but high hazard occupancies.

Note: See s. A52.011 for additional information regarding high hazard occupancies.

(b) *Limitations.* Except as provided in par. (c), the use of skylights with approved light-transmitting plastic glazing shall be limited as follows:

1. The light-transmitting plastic shall be mounted at least 4 inches above the plane of the roof on a curb construction consistent with that required for the class of construction of the building;

2. Dome-shaped skylights shall rise above the mounting flange a minimum distance equal to 10% of the maximum span of the dome but not less than 5 inches;

3. The edges of the light-transmitting plastic skylights or dome shall be protected by metal or noncombustible material;

4. Each skylight unit of CC 1 material may have a maximum of 300 square feet within the curb and each skylight unit of CC 2 material may have a maximum of 100 square feet within the curb;

5. The aggregate area of skylights may not exceed 33 $\frac{1}{3}$ % when CC 1 materials are used, and 25% when CC 2 materials are used, of the floor area of the room or space sheltered by the roof in which they are installed;

6. Skylights shall be separated from each other by a distance of not less than 4 feet measured in a horizontal plane; and

7. Where exterior wall openings are required to be fire protected, no skylight may be installed within 6 feet of such exterior wall.

8. Combinations of light-transmitting plastic roof panels and skylights shall be subject to the area and percentage limitations and separation requirements as specified in sub. (5) (b).

(c) *Exceptions.* 1. The requirements of par. (b) shall not apply, if:

a. The building on which the skylights of approved light-transmitting plastic glazing are located is not more than one story in height, is located not less than 30 feet from a property line and any other building on the property, and the room or space sheltered by the skylight is not a means of egress, a ch. Comm 58 occupancy, or a high hazard occupancy; or

b. The approved light-transmitting plastic material meets the roof cover requirements for the appropriate class of construction.

2. Except in chs. Comm 55 and 58 occupancies and high hazard occupancies, the requirements specified in par. (b) 4. to 6. shall not apply to skylights with approved light-transmitting plastic glazing provided:

a. The skylight serves as a fire venting system approved by a petition for variance as specified in s. Comm 50.25; or

b. The skylight is used in a building equipped with an approved automatic fire sprinkler system.

(7) LIGHT-DIFFUSING SYSTEMS. (a) *Light diffusers.* 1. Unless protected with an approved automatic fire sprinkler system, plastic light-diffusing systems may not be installed in:

a. Theaters and assembly halls under ch. Comm 55;

b. Health care, correctional and detention facilities under ch. Comm 58; and

c. High hazard occupancies.

Note: See s. A52.011 for additional information regarding high hazard occupancies.

2. Plastic light-diffuser panels shall be supported directly or indirectly from ceiling or roof construction by use of noncombustible hangers.

3. No plastic light-diffusing system may be installed in areas required to be equipped with automatic sprinklers unless appropriate tests by a recognized laboratory have shown that such system does not prevent effective operation of the sprinklers or unless sprinklers are located both above and below the light-diffusing system to give effective sprinkler protection.

4. Approved plastic materials for light-diffusing systems shall comply with s. Comm 51.07 unless the plastic panels comply with the following:

a. Fall from their mounting at an ambient temperature of at least 200°F. below the self-ignition temperature of the plastic material as measured by ASTM D 1929;

b. Remain in place at an ambient room temperature of 175°F. for a period of not less than 15 minutes; and

c. The maximum length of any single plastic panel does not exceed 10 feet and the maximum area of any single light diffuser does not exceed 30 square feet.

(b) Electrical lighting fixtures. Plastic light-transmitting panels and light-diffuser panels installed in approved electrical lighting fixtures shall comply with the requirements specified in par. (a) 4. a. to c.

(8) EXTERIOR VENEER. Approved light-transmitting plastic material may be installed as an exterior veneer for any building, provided:

(a) The plastic veneer may not be attached to any exterior wall to a height greater than 35 feet above grade;

(b) Sections of plastic veneer may not exceed 200 square feet in area; and

(c) Sections of plastic veneer shall be separated by a minimum of 4 feet vertically.

(9) INTERIOR SECONDARY GLAZING SYSTEMS. (a) Light-transmitting plastic materials used in interior secondary glazing systems shall comply with the requirements of s. Comm 51.07 unless the approved plastic used in the interior secondary glazing system meets the following requirements:

1. The approved plastic used as the glazing falls from its mounting either with or without its frame or sash at an ambient temperature of at least 200° F. below the self-ignition temperature of the plastic material as measured by ASTM D 1929;

2. Interior secondary glazing system is not installed over windows required for egress unless approved tests have shown that the system does not interfere with egress from the window; and

3. The maximum length of any single plastic panel does not exceed 10 feet and the maximum area of any single panel does not exceed 30 square feet.

History: Cr. Register, December, 1983, No. 336, eff. 1-1-84; cr. (1) (b) 3., Register, January, 1985, No. 349, eff. 2-1-85; am. (1) (b) 1. a. and b., (2) (a), Table 2, (6) (c) 2. a., (7) (a) 4.a. and (9) (a) 1. Register, August, 1985, No. 356, eff. 1-1-86; am. (1) (b) 1. intro., a. and b., (2) (a), Register, January, 1994, No. 457, eff. 2-1-94; r. and recr. (1) (b) and (c), Register, September, 2000, No. 537, eff. 10-1-00.

Comm 51.07 Interior finishes. (1) SCOPE. The requirements of this section apply to the interior finishes or surfaces of a building.

Note: See s. Comm 51.06 for the restrictions of foam plastics.

Note: Toxicity of the products of combustion is not included as a basis in determining the smoke developed criteria of this section. The smoke developed criteria is based solely upon the obscuration of light.

(2) APPLICATION TO MATERIALS. (a) Except as provided in par. (b), the classification of interior finish materials as specified in this section shall include the basic material used by itself or in combination with other materials.

(b) Subsequently applied paint or wall covering not exceeding $\frac{1}{28}$ inch in thickness and classified 450 or less on the smoke test scale are exempt from the provisions of par. (a).

(3) TRIM AND INCIDENTAL FINISH. (a) Interior finish not in excess of 10% of the aggregate wall and ceiling areas of any room or space may be Class C materials in occupancies where interior finish of Class A or Class B is required.

(b) In addition to the other requirements of this section, foam plastic used as interior trim and incidental finish shall also comply with the following:

1. The minimum density is 20 pounds per cubic foot;
2. The maximum thickness of the trim is 1/2 inch and the maximum width is 4 inches;
3. The trim constitutes no more than 10% of the area of any wall or ceiling; and
4. The flame-spread rating does not exceed 75 when tested

in accordance with ASTM E84 and the smoke developed rating is not limited.

(4) EXPOSED CONSTRUCTION. (a) This section does not require the installation of interior finish, but where construction or fire protection materials are exposed in rooms or spaces used for the occupancies specified, the hazard from rate of flame spread of the exposed materials shall be not greater than that of the interior finish permitted for such occupancy or use.

(b) Exposed portions of structural members of Type No. 4-Heavy Timber Construction shall not be subject to the interior finish requirements of this section.

(5) USE OF INTERIOR FINISHES. Interior finish material shall be used in accordance with requirements specified in Table 51.07.

TABLE 51.07
MINIMUM INTERIOR FINISH REQUIREMENTS

Occupancy	Required Exit Enclosures		Exit Access ^{1,2}		Rooms or Enclosed Spaces ^{1,2}	
	Walls & Ceilings ⁴	Floor ⁵	Walls & Ceilings ⁴	Floor ⁵	Walls & Ceilings ⁴	Floor
Ch. Comm 54 Occupancies Other than Storage and Warehouses	A	II	A or B	II	A, B or C	DOC FF-1 ⁶
Ch. Comm 54 Storage and Warehouse Occupancies	A or B	DOC FF-1 ⁶	A or B	DOC FF-1 ⁶	A, B or C	DOC FF-1 ⁶
Ch. Comm 55 Places of Assembly	A	I	A	II	A or B	DOC FF-1 ⁶
Ch. Comm 56 Places of Instruction	A	I	A or B	II	A, B or C	DOC FF-1 ⁶
Ch. Comm 57 Residential Occupancies	A	II	A or B	II	A, B or C	DOC FF-1 ⁶
Ch. Comm 58 Health Care and Places of Detention	SEE CHAPTER Comm 58 FOR SPECIFIC REQUIREMENTS					
Ch. Comm 59 Hazardous Occupancies	A	DOC FF-1 ⁶	A or B	DOC FF-1 ⁶	A, B or C	DOC FF-1 ⁶
Ch. Comm 60 Day Care Centers (20 Children or Less)	A or B	DOC FF-1 ⁶	A or B	DOC FF-1 ⁶	A, B or C	DOC FF-1 ⁶
Ch. Comm 60 Day Care Centers (More than 20 Children)	A	II	A or B	II	A, B or C	DOC FF-1 ⁶
Ch. Comm 62 Specialty Occupancies	A, B or C	DOC FF-1 ⁶	A, B or C	DOC FF-1 ⁶	A, B or C	DOC FF-1 ⁶

¹ Exposed portions of structural members of Type No. 4-Heavy Timber Construction are not subject to the requirements of this table.
² Where a complete automatic sprinkler system is installed, materials with an interior finish of Class B or C may be used in places where Class A or B materials, respectively, are required and floor finish materials with an interior finish of Class II or materials complying with the DOC FF-1-70 "pill test" may be used in places where Class I or II materials, respectively, are required.
³ Requirements for rooms or enclosed spaces are based upon the spaces being separated from exit access corridors and exits by partitions extending from the floor to the ceiling. Where the room or enclosed space is not separated from the exit access corridor, the room or space is considered part of the exit access or the exit.
⁴ Materials having napped, tufted, looped or similar surfaces, such as carpet, when applied on walls or ceilings shall meet the requirements for Class A interior finish.
⁵ Wood, vinyl, linoleum, terrazzo, resilient and other approved finished floors or floor covering materials are exempt from the provisions of this table.
⁶ All carpet manufactured for sale in the U.S. is required by federal regulations to comply with the DOC FF-1-70 "pill test" (16 CFR Para 1630). If a material other than carpet is used, the material should be shown to be resistant to flame propagation as a material which passes the DOC FF-1-70 test (minimum critical radiant flux of 0.04 watts/cm.
⁷ Class C interior finish materials may be used in places of assembly with a capacity of 400 persons or less.

(6) APPLICATION OF INTERIOR FINISH. (a) Attachment. Interior finish materials shall be applied or otherwise fastened in such a manner that they will not readily become detached when subjected to room temperature of 200° F. or less for 30 minutes, or otherwise become loose through changes in the setting medium from the effects of time or conditions or occupancy.

(b) Application to structural elements. 1. Interior finish materials applied to walls, ceilings or structural elements of a building or structure which are required to be of fire-resistive rated or non-combustible construction shall be applied directly against the exposed surface of such structural elements or to furring strips attached to such surfaces.

2. Where furring strips are used, all concealed spaces shall be firestopped into areas not greater than 10 square feet in area or 8 feet in any dimension.

(c) Furred construction. Where walls, ceilings or other structural elements are required to be of fire-resistive rated or noncombustible construction, and the interior finish is set out or dropped distances greater than 1 3/4 inches from the surface of the elements, only material of which both faces qualify as Class A shall be used, unless the finish material is protected on both sides by an approved automatic fire suppression system or is attached to a noncombustible backing as specified in par. (e) or to furring strips applied directly to such backing as specified in par. (b).

(d) Class B and C finish materials. Interior finish materials, other than Class A materials, which are less than 1/4 inch in thickness shall be applied directly against a noncombustible backing or a backing of fire-retardant treated wood unless the tests under which the material has been classified were made with the materials suspended from the noncombustible backing.

(e) *Backing material.* 1. Backing for interior finish materials shall be a continuous surface with permanently tight joints, equal in area to the area of the finish, and extending completely behind such finish in all directions.

2. Backing shall be of noncombustible or fire retardant treated wood materials.

3. When the backing does not constitute an integral part of the structural elements or system, it shall be attached directly to the structural elements or to furring strips as specified in par. (b) or may be suspended from the structural members at any distance provided concealed spaces are firestopped as specified in s. Comm 53.63 (1).

Note: See s. Comm 51.01 (75a) for further explanatory information. Class A Inte-

rior Finish—flame spread 0–25, smoke developed 0–450.

Class B Interior Finish—flame spread 26–75, smoke developed 0–450.

Class C Interior Finish—flame spread 76–200, smoke developed 0–450.

Class I Interior Floor Finish—critical radiant flux—.45 watts/cm²

Class II Interior Floor Finish—critical radiant flux—.22 watts/cm²

History: Cr. Register, December, 1981, No. 312, eff. 1–1–82; am. table, Register, October, 1982, No. 322, eff. 11–1–82; renum. (3) to be (3) (a), cr. (3) (b) and (6), Register, December, 1983, No. 336, eff. 1–1–84; am. (6) (d) (intro.), Register, August, 1985, No. 356, eff. 1–1–86.

Comm 51.08 Occupancy separations and hazard enclosures. (1) When a building is used for more than one occupancy purpose, each part of the building comprising a distinct occupancy division shall be separated from any other occupancy division in accordance with Table 51.08–1.

TABLE 51.08-1
OCCUPANCY SEPARATIONS
Minimum Fire Resistive Ratings in Hours

Occupancies	Ch 54	Ch 55		Ch 56	Ch 57	Ch 58		Ch 59				Ch 60	Ch 61	Ch 62 Open Parking Structures		
		Occupants ≤750	Occupants >750			Health Care	Detention	≤500 sq ft		>500 sq ft						
								Storage	Repair	Storage	Repair					
Ch 54	0	3 ⁿ	4 ⁿ	0	i	2 ⁿ	2 ^b	1 ^{c,d}	2	2 ^{c,d}	3	0	0	NC-2		
Ch 55 ≤750 occupants	3 ⁿ	3 ^e	4 ^e	3 ^{f,g}	3	3 ^a	3 ^b	3	4	3	4	3 ^h	3	3		
	4 ⁿ	4 ^e	4 ^e	4 ^{f,g}	4	4 ^a	4 ^b	4	4	4	4	4 ^h	4	4		
Ch 56	0	3 ^{f,g}	4 ^{f,g}	0	i	2 ^a	2 ^b	2	3	2	3	0	0	NC-2		
Ch 57	i	3	4	i	i	2 ^a	2 ^b	1 ^c	2	2 ^{c,i}	3	i	i	NC-2		
Ch 58 Health Care	2 ^a	3 ^a	4 ^a	2 ^a	2 ^a	0	2 ^b	3	4	3	4	2	2	NC-2		
	2 ^b	3 ^b	4 ^b	2 ^b	2 ^b	2 ^b	0	3	4	3	4	2	2	NC-2		
Ch 59 Storage	1 ^{c,d}	≤500 sq ft	3	3	2	1 ^c	3	3	0	1 ^k	1 ^k	1 ^k	1	m	1 ^k	
		Repair ≤500 sq ft	4	4	3	2	4	4	1 ^k	0	1 ^k	1 ^k	2	2	1 ^k	
		Storage >500 sq ft	2 ^{c,d}	3	3	2	2 ^{c,j}	3	3	1 ^k	1 ^k	0	1 ^k	2	m	1 ^k
		Repair >500 sq ft	3	4	4	3	3	4	4	1 ^k	1 ^k	1 ^k	0	3	3	1 ^k
Ch 60	0	3 ^h	4 ^h	0	i	2	2	1	1	2	3	0	0	NC-2		
Ch 61	0	3	4	0	i	2	2	m	2	m	3	0	0	NC-2		
Ch 62 Open Parking Structures	NC-2	3	4	NC-2	NC-2	NC-2	NC-2	1 ^k	1 ^k	1 ^k	1 ^k	NC-2	NC-2	0		

Keys and Examples: NC = Noncombustible construction; 0 = 0 (No hourly rating); NC-2 = Noncombustible construction 2-hour rating

^a Auditoriums, chapels, residential facilities and other similar areas provided for the patients or employees of health care facilities need not be separated from the health care facility. Also, administrative offices, doctors' offices, medical clinics and laboratories which are intended primarily to provide in-house services or support to the health care facility need not be separated from the health care facility. Doctor's offices, medical clinics and other similar areas which are intended to provide out-patient services independent of the health care facility shall be separated in accordance with the table.

^b Auditoriums, chapels, residential facilities, administrative offices, medical clinics, educational facilities, workshops and other similar areas which are provided for the residents or employees of the detention facility need not be separated from the facility.

^c An occupancy separation need not be provided within a fire station or other similar facility to separate vehicles from other areas of the building, if the vehicles are directly and permanently related to the functions of the building.

^d An occupancy separation need not be provided within an office, factory or warehouse occupancy to separate a storage garage accommodating one or 2 vehicles which are directly related to the functions of that occupancy. If a storage garage accommodating one or 2 vehicles within an office, factory or warehouse occupancy is part of a multi-occupancy/multi-tenant building (i.e., strip shopping center), the occupancy separation shall be provided at least at the adjoining tenants' walls.

^e An occupancy separation need not be provided to separate 2 adjoining assembly hall areas or functions located within the same building, if the operation or control of the 2 assembly areas are under the same owner or tenant.

^f An occupancy separation need not be provided between a church and a day school operated by the church provided both occupancies conform with the most restrictive requirements of chs. Comm 55 and 56.

^g An occupancy separation need not be provided between an assembly hall or theater and an instructional facility regulated under ch. Comm 56 if the operation and control of the two occupancies is under the same owner.

^h An occupancy separation need not be provided to separate a day care center from an assembly hall occupancy, if the day care center conforms with the more stringent requirements of ch. Comm 55.

ⁱ See s. Comm 57.01 concerning living unit separations.

^j Storage garages, attached to residential occupancies under the scope of ch. Comm 57, may be separated from a residential occupancy by at least one-hour fire-resistive construction, if the storage garage is divided by walls with at least one-hour fire-resistive ratings into spaces with floor areas not exceeding 600 square feet.

^k An occupancy separation need not be provided to separate adjoining storage garages, repair garages or open parking structures which are located within the same building, if the entire building conforms to the most stringent occupancy requirements of chs. Comm 59 and 62, subch. I.

^m Storage garages, attached to CBRF occupancies under the scope of ch. Comm 61, may be separated from a CBRF by:
 —Common walls between the garage and the CBRF protected with not less than one layer of 5/8-inch Type X gypsum board with taped joints, or equivalent, on the garage side and with not less than one layer of 1/2-inch gypsum board with taped joints, or equivalent, on the CBRF side;
 —Floor-ceiling assemblies between garage and the CBRF protected with not less than one layer of 5/8-inch Type X gypsum board on the garage side of the ceiling or roof framing; and
 —Openings between the garages and the CBRF protected by self-closing, 1 3/4-inch solid wood core doors or with self-closing doors of equivalent fire-resistive rating.

ⁿ Public mausoleums constructed adjacent to or as part of an assembly hall need not be provided with an occupancy separation.

^o All openings in occupancy separations involving detention facilities shall be protected by fire-resistive door assemblies as specified in s. Comm 58.60.

Note: See s. Comm 61.10 (2) concerning detached garages serving CBRF's.

Note: Department of health and family services has stricter requirements for buildings with joint occupancies. See HFS 83.41 (12).

**Table 51.08-2
HAZARD ISOLATION**

Occupancy	Minimum Fire-Resistive Rating In Hours ¹		Exceptions
	≤3 stories	> 3 stories	
Ch 54	2	2	1-hour isolation permitted for 1-story bldgs <3,000 ft ²
Ch 55	3	3	2-hour isolation permitted for bldgs with a capacity of ≤300 people
Ch 56	4	4	2-hour isolation permitted for 1-story bldg
Ch 57	1	2	
Ch 58	2	3	
Ch 59	2	2	
Ch 60	1	2	
Ch 61	Not Applicable	Not Applicable	
Ch 62 Open parking structures & assembly seating facilities	2	2	
Ch 62 Greenhouses	1	Not Applicable	
Ch. 62 Mini-storage Buildings	2	2	1-hour isolation permitted for 1-story bldgs < 3,000 ft ²

¹ Fire-resistive ratings may be reduced in accordance with s. Comm 51.02 (22).

(2) HAZARD ISOLATION. (a) *General*. 1. Fire hazards shall be stored or isolated in accordance with this section.

2. Fire-resistive rated construction specified in Table 51.08-2 and this section shall comply with ss. Comm 51.04 to 51.049.

3. Fire detection, prevention, suppression and isolation features required under an adopted NFPA standard referenced in this section shall be provided as specified in the standard.

4. a. Except as required under subd. 4. b., fuel-fired equipment that is used for processes directly related to the business and is normally in view of employees and under the control of employees while in operation is not required to be isolated.

b. If the adopted NFPA standard has isolation requirements, those requirements shall be followed.

Note: Examples of processes directly related to the business include cooking equipment at a restaurant, manufacturing process equipment, dryers at a commercial laundry, etc.

(b) *Fuel-fired heating equipment*. 1. Except as provided in subd. 2. and 3., fuel-fired heating equipment shall be provided with a fire-resistive rated enclosure as follows:

a. Gas- and oil-fired boilers, furnaces and water heaters shall be provided with a one-hour fire-resistive rated enclosure.

b. Solid fuel-fired boilers, furnaces and water heaters shall be provided with a two-hour fire-resistive rated enclosure.

c. For occupancies under ch. Comm 59, no openings other than self-closing doors are allowed within 18 inches of the floor in a required enclosure for fuel-fired heating equipment.

2. Fuel-fired heating equipment may be used without a fire-resistive rated enclosure as follows:

a. For occupancies under chs. Comm 54, 55, 56, 57, 59, 60, 61, 62 and 66, a direct vent sealed combustion chamber appliance may be used without a rated enclosure.

b. Suspended equipment, where allowed under ss. Comm 64.21 and 64.22 may be used without a rated enclosure.

c. For occupancies under chs. Comm 54, 55, 56 and 58, gas-fired booster water heaters used exclusively for sanitizing dishes and cooking utensils may be used without a rated enclosure.

3. For occupancies under ch. Comm 56, the following equipment may be used without a rated enclosure in the shop area provided the shop area is separated from other areas of the building by 3-hour fire-resistive construction:

a. Vented gas or oil open flame infrared equipment with surface temperatures that exceed 1500 °F.

b. Unvented gas direct-fired make-up air units.

(c) *Clothes dryers*. 1. Except as allowed in subd. 2, all gas, oil or electric clothes dryers shall be isolated by 2-hour fire-resistive rated construction.

2. The following exceptions apply to occupancies under chs. 54, 55, 56, 57, 59 and 60:

a. The 2-hour fire-resistive rating is not required for the isolation of clothes dryers where the entire room containing the dryers is provided with automatic fire sprinkler protection and, for gas-fired dryers, each dryer is protected with an automatic shut-off valve that stops the gas flow if there is a sudden pressure drop in the fuel supply system.

b. The 2-hour fire-resistive rating is not required for the isolation of clothes dryers where no more than two dryers with a maximum rating of 37,000 Btu each are contained in the room, and for gas-fired dryers, each is protected with an automatic shut-off valve that stops the gas flow if there is a sudden pressure drop in the fuel supply system.

(d) *Generators*. 1. Fuel-fired generators shall be isolated with fire-resistive construction with hourly ratings in accordance with the fire enclosure requirements of Table 51.03-A, line 20.

2. Emergency generators required by ch. Comm 16, Table 16.46, shall be isolated as required in subd. 1, with no other equipment allowed in the room that is not an integral part of a required emergency power supply system.

(e) *Fire pumps*. Fire pumps shall be isolated with fire resistive construction with hourly ratings in accordance with the fire enclosure requirements of line 20, Table 51.03-A.

(f) *Flammable and combustible liquids*. Flammable and combustible liquids shall be stored and isolated in accordance with NFPA 30 and 30A.

(g) *Aerosols*. Aerosols shall be stored and isolated in accordance NFPA 30B.

(h) *Smokeless propellants*. Smokeless propellants shall be stored and isolated in accordance with NFPA 495.

(i) *Fireworks, black powder and explosive materials*. Fireworks, black powder and explosive materials shall be stored and isolated in accordance with ch. Comm 7.

(j) *Flammable and combustible gases*. 1. Liquefied petroleum gas. Liquefied petroleum gas shall be stored and isolated in accordance with ch. Comm 40.

2. Gases for welding, cutting and allied processes. Gases for welding, cutting and allied processes shall be stored and isolated in accordance with NFPA 51.

(k) *Spray applications*. Flammable or combustible materials used in spray applications shall be isolated and protected in accordance with NFPA 33.

(L) *Coating or dipping applications*. Flammable or combustible materials used in coating or dipping applications shall be stored and isolated in accordance with NFPA 34.

(m) *Liquid and solid oxidizers*. Liquid and solid oxidizers shall be stored and isolated in accordance with NFPA 430.

(n) *Organic peroxides*. Organic peroxides shall be stored and isolated in accordance with NFPA 432.

(o) *Laboratory chemicals*. Laboratory chemicals falling under the scope of NFPA 45 shall be stored and isolated in accordance with NFPA 45.

(p) *Hazardous areas*. Hazardous areas, including trash collection rooms, recycling areas, woodworking areas, maintenance shops and similar areas determined by the department shall be isolated in accordance with Table 51.08-2.

(3) (a) Openings in occupancy separations shall be protected by fire-door assemblies as specified in s. Comm 51.047 or by fire-window assemblies as specified in s. Comm 51.048 or as specified in s. Comm 51.049.

(b) Openings in hazard enclosures shall be protected with self-closing fire door assemblies as specified in s. Comm 51.047 or by fire-window assemblies as specified in s. Comm 51.048 or as specified in s. Comm 51.049.

History: 1-2-56; r. and recr. (2) (c), Register, October, 1967, No. 142, eff. 11-1-67; am. (2) (a), (b) and (c), Register, February, 1971, No. 182, eff. 7-1-71; r. and recr. (2) (a), (b) and (c) eff. 8-1-71 and expiring 1-1-72 and cr. (2) (a), (b) and (c) eff. 1-1-72, Register, July, 1971, No. 187; am. (2) (b) 1., Register, December, 1978, No. 276, eff. 1-1-79; r. and recr. (2), Register, December, 1981, No. 312, eff. 1-1-82; am. (2) (a) and (b) (intro.), Register, October, 1982, No. 322, eff. 11-1-82; am. (2) (a) (intro.) and (b) (intro.), Register, August, 1985, No. 356, eff. 1-1-86; r. and recr. Register, February, 1991, No. 423, eff. 4-1-91; am. Table 51.08, Register, March, 1992, No. 435, eff. 4-1-92; renum (2) to be (3), cr. (2), Register, January, 1994, No. 457, eff. 2-1-94; am. Table 51.08 Footnote j, Register, March, 1995, No. 471, eff. 4-1-95; am. (1), (2), renum. Table 51.08 to 51.08-1 and am., cr. Table 51.08-2, Register, December, 1995, No. 480, eff. 4-1-96; emerg. r. and recr. Table 51.03-2, eff. 4-6-96; r. and recr. Table 51.03-2; Register, December, 1996, No. 492, eff. 1-1-97; r. and recr. Register, March, 1997, No. 495, eff. 4-1-97; r. and recr. (2), Table 51.08-2, renum. and am. (3) to be (3) (a) and cr. (3) (b), Register, March, 2000, No. 531, eff. 4-1-00.

Comm 51.14 Safety glazing. (1) **SCOPE.** This section applies to fixed or operating glazed flat panels adjacent to doors; fire window assemblies; display cases within 7 feet of the floor in schools; skylights; sloped glazing and any other glazing materials used in hazardous impact areas which are not included within the scope of the federal consumer product safety commission (CPSC) standard for architectural glazing materials, 16 CFR 1201.

Note: The CPSC standard for architectural glazing materials pre-empts state and local regulations for framed or unframed interior or exterior glazed doors, exterior doors with glazed lights, sliding doors and the adjacent glazed fixed or operating panel, storm doors, shower doors, walk-in mirror closet doors and tub enclosures.

(2) **APPLICATION.** All glazing material used in hazardous impact locations shall be safety glazing material. All replacements of glazing material in hazardous impact locations made after November 30, 1976, shall be safety glazing, except that the replacement of glazing shall be as specified in sub. (3).

(a) **Location.** Hazardous impact locations shall include all glazed elements such as framed or unframed interior or exterior

glass doors, the first fixed or operating flat panel within 2 feet of nearest vertical edge of an entrance or exit door, exterior doors with glass lights, or any other glazed elements which may be mistaken for a means of egress or ingress to a room or building. Other hazardous impact locations shall include sliding doors and the adjacent glazed fixed or operating panel, storm doors, shower doors, tub enclosures and display cases within 7 feet of the floor in schools except as follows:

1. A fixed or operating flat panel immediately adjacent to an entrance or exit door is exempt from the requirements of this paragraph if the lower horizontal edge of the panel is 2 feet or more above the floor; or

2. Any mirror, framed glazed picture or similar decorative object which is attached to a door or wall in a hazardous impact location and which does not in whole or in part conceal any opening in such door or wall is exempt from the requirements of this paragraph.

(b) **Material.** Safety glazing shall include any glazing material including but not limited to tempered glass, laminated glass, wired glass, safety plastic, or safety insulating units which meet the test requirements of ANSI Z97.1, and which are constructed, treated or combined with other materials so as to minimize the likelihood of cutting and piercing injuries resulting from human impact with the glazing material.

(c) **Labeling.** Safety glazing material shall be labeled with a permanent label by such means as etching, sand blasting, firing of ceramic material, or hot die stamping. The label shall be legible and visible after installation. Labels identifying safety glazing materials may be omitted provided that a notarized affidavit or invoice is submitted to the department or owner upon request certifying the installation of safety glazing material. The label or affidavit shall identify the seller, manufacturer, fabricator, or installer, the nominal thickness and type of safety glazing material, and the fact that the material meets the test requirements of ANSI Z97.1.

(3) **GUARDING OF GLAZING.** All interior and exterior glazed panels, subject to human impact not in a hazardous impact location, shall be guarded or provided with safety glazing, except that glazed panels with a sill height of 2 feet or more, or glazed panels less than 12 inches in width, are not required to be safety glazed or guarded.

(a) Guarding shall consist of a horizontal bar, rail, mullion, grille or screen at least 1½ inches wide and located within 3 feet 6 inches to 4 feet 6 inches above the floor. The guard assembly shall be capable of withstanding a lateral force of 100 pounds applied at any point and installed to avoid contact with the glazing when the force is applied.

(b) Safety glazing materials shall be as specified in sub. (2) (b).

(c) For replacement of glazing in buildings contracted for or existing prior to November 30, 1976, the installation of a horizontal bar, rail, mullion, grille or screen as a protective device may be provided in lieu of safety glazing material in hazardous impact locations where safety glazing would be impractical because of the size of the light required.

(4) **INTERIOR DOORS WITH GLASS LIGHTS.** (a) All interior doors with glass lights greater than 8 inches in the least dimension shall be provided with safety glazing material.

(b) All interior doors with glass lights less than 8 inches in the least dimension shall be provided with 1/4-inch glazing material.

(c) Safety glazing materials shall be as specified in sub. (2) (b).

(5) **SKYLIGHTS AND SLOPED GLAZING.** (a) *Skylights.* All glazing in skylights shall be safety glazing material, and light-transmitting plastic shall comply with the requirements specified in s. Comm 51.065 (5) or (6).

(b) *Sloped glazing.* All glazing installed more than 15° with the vertical shall be safety glazing material. This paragraph does not apply to greenhouses.

(c) **Protection.** 1. Except as provided in subd. 2., heat-strengthened glass or fully tempered glass if used in an overhead

application shall have a screen or equivalent protection installed below the glass.

- a. The screen shall be installed not more than 4 inches from the glass.
- b. The screen shall be capable of supporting the weight of the glass.
- c. The screen shall be constructed of noncombustible material not thinner than 0.08 inches.
- d. The mesh in a screen may not be larger than one inch by one inch.

2. a. Fully-tempered glass may be used without a screen or equivalent protection, if the glass is at a slope of 30° or less from vertical and the highest point of the glass is 10 feet or less above any floor level under the sloped glass.

b. Glazing materials may be used without a screen or equivalent protection, if the walking surface or any other accessible area below the glazing is permanently protected from the risk of falling glass for a minimum horizontal distance equal to twice the height.

(6) FIRE WINDOW ASSEMBLIES. All glazing in fire window assemblies shall be designed and installed as specified in s. Comm 51.048.

(7) STRUCTURAL REQUIREMENT. Glazing material shall be designed and installed to safely withstand the loads specified in ch. Comm 53.

Note: Section 101.125, Stats., requires safety glazing in all hazardous locations. History: Cr. Register, December, 1981, No. 312, eff. 1-1-82; am. (5) (a), Register, August, 1985, No. 356, eff. 1-1-86; am. (1), cr. (5) (c), Register, March, 1991, No. 423, eff. 4-1-91; am. (2) (b) and (c), (5) (a), Register, January, 1994, No. 457, eff. 2-1-94.

Comm 51.15 Standard exit doors. (1) Every door which serves as a required exit door or exit access door from an area, room, public passageway, stairway or building shall be a standard exit door, unless exempted by the occupancy requirements of this code.

Note: See ss. Comm 54.06, 55.10, 56.08, 57.06, 58.04, 58.49, 59.14, 60.12, 61.12, 62.26, 62.47 and 62.75 for requirements regarding required exits.

(2) Every standard exit door shall swing outward or toward the natural means of egress. It shall be level with the floor, and shall be so hung that, when open, it will not block any part of the required width of any other doorway, passageway, stairway or fire escape. No revolving door, overhead door or sliding door may be considered as a standard exit, except as permitted in the occupancy chapters of this code.

(3) (a) A standard exit door shall have such fastenings or hardware that it can be opened from the inside by pushing against a single bar or plate or turning a single knob or handle. The latch or other approved fastening device on the door shall be of an obvious method in its release. Except as provided in pars. (b) to (d), the installation of hardware requiring use of a key for opening an exit door from the inside is prohibited. The requirements of this subsection, except par. (g) shall apply to all buildings in existence and to any building built after the effective date of this subsection.

(b) Exit and exit access doors serving individual living units may be provided with hardware requiring the use of a key for opening from the inside.

(c) Upon written request to the department by the owner, key-locking or securing of exits may be approved in fire-resistive buildings, or parts of fire-resistive buildings, which are used as jails, prisons, mental institutions, asylums, nursing homes with senile patients, and similar type occupancies which were constructed prior to January 1, 1982.

Note: This code paragraph applies only to buildings constructed prior to 1982. Refer to ch. Comm 58 for buildings constructed after 1981.

Note: The owner's request should include the following considerations: accessibility of keys to the fire department and staff personnel for the locked areas; electrical devices which release the locks; and 24-hour supervision of the locked areas by personnel who carry keys for the locked areas while on duty. Electrical devices which release the locks upon power failure or upon activation of the fire alarm or sprinkler system or the product of combustion detectors should be considered for securing of exits in nursing homes.

Note: Written approval to lock exits must also be obtained from the department of health and social services in accordance with the rules of that department.

(d) 1. One door serving as an exit from any building housing any office or wholesale or retail store may be equipped with hardware which requires use of a key to open it from the inside provided one of the following conditions is satisfied:

a. The door has a window which has a minimum clear opening of not less than 24 inches, and 6 square feet in area with the bottom of the window opening not more than 4 feet above the inside floor level;

b. A glazed sidelight satisfying the dimensional and location requirements for the windows specified in par. (a) is located adjacent to the door; or

c. A window satisfying the dimensional and location requirements for the window specified in par. (a) is located within five feet of the door.

2. Approved safety glazing shall be used in all installations but the glazing may not be bullet-resistant or break-resistant.

3. The door may not be used as an exit serving any required exit stairway enclosure.

4. The door shall not be key-locked during periods of occupancy by the public or employees. A readily visible, permanent sign shall be placed on or adjacent to the door on the egress side stating, "THIS DOOR SHALL NOT BE KEY-LOCKED WHEN THE BUILDING IS OCCUPIED". The sign shall be in letters at least one inch in height on a contrasting background.

5. The use of keyed hardware as specified in this section may be revoked by the department or its authorized deputy upon one violation of any of the conditions specified in subds. 1. to 4.

(e) 1. Except as provided in subd 2., the door shall not be barred, bolted or chained at any time.

2. When authorized persons, such as employees, frequenters, patrons and other such occupants are not present, the exit door may be secured by the use of a single bar or bolt. A sign or label shall be posted on the door near the single bar or bolt. The sign or label shall bear the following: "This bolt or bar shall be kept open during periods of occupancy."

Note: The intent of subd. 2. is to prohibit padlocks or use of a key to open a door or lock at any time. The bar and bolt exception is to give security against intruders from the outside while protecting persons in the building from being trapped.

(f) 1. Except as provided in subd. 2., in a building protected throughout by either a supervised automatic fire sprinkler system or a supervised automatic fire detection system, the exit doors may be equipped with listed, locking devices which shall:

a. Release or unlock upon activation of the sprinkler system or fire detection system;

b. Release or unlock upon the loss of power to the locking device;

c. Release or unlock within 15 seconds whenever a force of not more than 15 pounds of force is continuously applied to the release device for a period of not more than 3 seconds;

d. Upon the release or unlocking of the door activate an audible alarm in the vicinity of the door;

e. Require the manual relocking of such doors; and

f. Have a sign adjacent to the locking device indicating how the door may be opened.

2. The use of locking devices as described in subd. 1. shall be limited to the following restrictions.

a. The locking device may not be employed on any door of an occupancy designated or licensed as a community based residential facility.

b. The locking devices may not be employed on any doors serving as the main entrance/exit of an assembly hall occupancy regulated under ch. Comm 55.

c. Not more than one locking device may be employed in any egress path within a health care facility regulated under ch. Comm 58, subch. I.

(g) 1. Except as provided in subd. 2., the latch or other approved fastening device shall be located on the exit door so that the device is not less than 32 inches or more than 54 inches above the floor level.

2. The latch or approved fastening device on solid tempered glass doors may be located on the door at the floor line.

(h) Any door in a required means of egress serving an area or areas having an occupant load of 100 or more persons shall be provided with panic hardware. Acceptable panic hardware shall be a door latching assembly which complies with subsd. 1. to 3.

1. The assembly shall cause the door latch to release and the door leaf to open, when a force of 15 pounds and greater is applied in the direction of egress, to a bar or panel.

2. The activating portion of the bar or panel in par. (a) shall extend not less than one-half the width of the door leaf, and shall be mounted at a height of at least 30 inches but no more than 44 inches above the floor.

3. The force specified in par. (a) shall be applied at the latch side of the door.

(4) A standard exit door shall not be less than 6 feet 4 inches high by 3 feet 0 inches wide, except where especially provided under occupancy classifications and in s. Comm 51.20. Where double doors are provided with or without mullions, the width of each single door may be reduced to 2 feet 6 inches, except double doors utilized to provide accessibility in accordance with ch. Comm 69 shall have the clear width of at least one single door increased to 32 inches.

(5) (a) All exit doors, unless otherwise exempted by the occupancy requirements of this code, shall be identified by illuminated translucent exit signs.

1. An exit sign shall bear the words "EXIT" or "OUT".

2. The wording for the exit sign shall be of letters not less than 6 inches high with principal strokes of letters not less than $\frac{3}{4}$ inches wide.

3. The wording for the exit sign shall be of red or green lettering on a contrasting background.

4. A self-luminous type of exit sign which provides evenly illuminated letters shall have a minimum luminance of 0.06 foot lamberts; other types of exit signs shall be illuminated by a source providing not less than 5 foot candles at the illuminated surface.

(b) When exit doors are not readily visible to occupants, directional exit signs shall be provided in exit access corridors and other appropriate locations so to indicate the direction and way of egress.

(6) (a) The required aggregate width of exits from a level shall be determined by using the full occupant load of that level, plus the percentage effects of the occupant loads of adjacent levels (above and below) which exit through it as follows:

Note: See Appendix A for further explanatory material.

1. 50% of the occupant load of each first-adjacent level; and

2. 25% of the occupant load of each second-adjacent level.

(b) The width shall be based upon the following ratios:

1. Types No. 1 through No. 4 construction unsprinklered, 40 inches per 100 persons;

2. Types No. 5 through No. 8 construction unsprinklered, 50 inches per 100 persons;

3. Types No. 1 through No. 4 construction sprinklered, 30 inches per 100 persons; or

4. Types No. 5 through No. 8 construction sprinklered, 40 inches per 100 persons.

Note: The determination of exit width for health care facilities is specified in s. Comm 58.12 (2) and (3) and takes precedence over this section.

(c) The required aggregate width of exits from assembly seating facilities shall comply with the requirements of s. Comm 62.75 (4).

History: 1-2-56; am. Register, December, 1962, No. 84, eff. 1-1-63; am. (5) and cr. (7), Register, November, 1963, No. 95, eff. 12-1-63; r. and recr., Register, Octo-

ber, 1967, No. 142, eff. 11-1-67; am. (7) (j), Register, May, 1968, No. 149, eff. 6-1-68; r. and recr. (7), Register, December, 1970, No. 180, eff. 1-1-71; r. and recr. (3), Register, February, 1971, No. 182, eff. 3-1-71; am. (7) (a) 1., Register, September, 1973, No. 213, eff. 10-1-73; r. (7), r. and recr. (6), Register, December, 1974, No. 228, eff. 1-1-75; emerg. cr. (3) (b) 1., eff. 6-20-75; cr. (3) (a) 1. and (3) (b) 1., Register, November, 1975, No. 239, eff. 12-1-75; am. (4), Register, December, 1977, No. 264, eff. 1-1-78; am. (2) and (3) (b) 1., Register, December, 1978, No. 276, eff. 1-1-79; am. (4), Register, January, 1980, No. 289, eff. 2-1-80; am. (2), r. and recr. (3) (a), (intro.), cr. (6) (c), Register, December, 1981, No. 312, eff. 1-1-82; cr. (3) (c), Register, December, 1983, No. 336, eff. 1-1-84; r. and recr. (3), Register, January, 1985, No. 349, eff. 2-1-85; am. (3) (a) and (4), cr. (3) (c) and (f), Register, August, 1985, No. 356, eff. 1-1-86; am. (2), (3) (a), renum. (3) (f) to be (3) (g), cr. (3) (f), r. and recr. (5), Register, February, 1991, No. 423, eff. 4-1-91; am. (1), (2) and (3) (c), cr. (3) (b), Register, January, 1994, No. 457, eff. 2-1-94; am. (4), Register, September, 2000, No. 537, eff. 10-1-00.

Comm 51.151 Exit distribution. All spaces which can accommodate more than 25 persons shall be provided with a minimum of 2 exits, 2 exit access doors or a combination of both which are located to provide the best possible egress from the room or suite. If exit access doors are used, the exit access corridors shall lead to 2 or more separate exits.

Note: See Appendix A for further explanatory material.

Note: See occupancy chs. Comm 54 to 62 for acceptable types of exits and exit accesses and exceptions.

History: Cr. Register, August, 1985, No. 356, eff. 1-1-86.

Comm 51.152 Egress configuration. (1) EGRESS DIRECTIONS. (a) Where 2 directions of egress are required, and are provided by doors opening into corridors, the angle between the 2 directions shall not be less than 90°.

(b) An angle between directions of egress within a space shall be satisfactory providing passageways are maintained to corridor access points separated a distance of at least one-half of the diagonal of the area served, or 20 feet, whichever is greater.

(2) RECESSED DOORS. Where 2 directions of egress are required, and are provided by recessed doors opening into the corridors, the doors shall be recessed no more than 3 feet into an alcove serving only that exit access, and the alcove width shall be at least 3 feet.

Note: See Appendix A for further explanatory material.

History: Cr. Register, December, 1993, No. 456, eff. 1-1-94.

Comm 51.16 Stairways and ramps. (1) DEFINITIONS.

(a) "Stairway" means one or more flights of steps, and the necessary platforms or landings connecting them, to form a continuous passage from one elevation to another, including exterior porches, platforms and steps.

(b) "Ramp" means a sloping floor or walk and necessary platforms or landings connecting them to form a continuous passage from one elevation to another.

(2) REQUIRED AGGREGATE WIDTH. (a) The required aggregate width of stairway or ramp exits from any level shall be as specified in s. Comm 51.15 (6).

(b) In no case shall the minimum width of an exit stair or ramp be less than that specified in sub. (3).

(c) Under no circumstances shall stairways or ramps decrease in width in the line of travel toward the exit.

(3) MINIMUM WIDTH. (a) Except as provided in pars. (b) and (c), every required exit stairway or ramp under chs. Comm 54 to 62 shall be not less than 3 feet 8 inches wide, except as provided in the occupancy chapters, of which not more than 4 inches on each side may be occupied by a handrail. The clear dimension between handrails, or stringers, shall not be less than 3 feet 0 inches.

(b) Nonrequired stairways or ramps need not conform to the width requirements specified in chs. Comm 50 to 64.

(c) A required stairway or ramp serving a space with an occupant load not greater than 25 persons shall have a width of not less than 3 feet.

(4) RISERS, TREADS AND RAMP SLOPES. Risers and treads shall be designed and provided in accordance with the following:

(a) 1. Except as provided in subd. 2., all stairways and steps shall have a rise of not more than 7 inches measured from tread

to tread, and a tread of not less than 11 inches, measured from nosing to nosing of tread. The slope of a tread may not exceed 1/4 inch per foot for the depth of the tread. Treads and risers shall be uniform in any one flight. Winders may not be used.

2. Existing stairways and steps in existing buildings, where a change in occupancy is occurring, may remain in use if they were constructed in accord with the requirements of this code relating to the proposed occupancy, that were in effect at the time of that construction.

Note: The department recommends that steps be proportioned so the sum of 2 risers and a tread, exclusive of its nosing or projection, should be not less than 24 inches or more than 25 inches.

Note: The department may accept nonstandard exit stairways serving unoccupied areas, such as equipment mezzanines or platforms, and similar areas, if approved in writing.

Note: See chs. Comm 66 and 69 for additional requirements for stairways.

(b) The edges of all treads and the edges of all stairway landings shall be finished with a nonslippery surface not less than 3 inches in width;

(c) Where an exit door leads to an outside platform or sidewalk, the level of the platform or sidewalk shall not be more than 7-3/4 inches below the doorsill;

(d) Every stairway flight shall have at least 3 risers, except as provided in par. (c) and ss. Comm 54.03 (1) (b), 55.09 (3) and 57.07 (1); and

(e) There shall be no more than 22 risers in any one flight.

(f) Slopes of ramps located in required means of egress shall comply with ch. Comm 69. Slopes of ramps not located in required means of egress shall not exceed 1 foot of rise in 6 feet of run.

(g) Ramps and landings shall be finished with a slip-resistant surface.

(5) STAIRWAY AND RAMP LANDINGS AND PLATFORMS. (a) 1. Except as provided in subd. 2., if a door is provided at the head or foot or both of a stairway or ramp, a landing or platform shall be placed between the door and the stairway or ramp regardless of the direction of swing of the door.

2. Platforms may be omitted for ramps 6 foot or less in length.

(b) Every landing or platform shall be at least as wide as the stairway or ramp, measured at right angles to the direction of travel. Every landing or platform must have a length of at least 3 feet, measured in the direction of travel.

(6) CURVED STAIRS. Interior or exterior curved stairs used as required exits shall meet all the requirements for stairways. Curved stairs shall have a radius of at least 25 feet at the interior edge of the tread.

(7) SPIRAL STAIRS. Spiral stairways may be permitted as specifically allowed by the occupancy chapters of this code. Such spiral stairs shall provide a clear walking area measuring at least 22 inches from the outer edge of the supporting column to the inner edge of the handrail and shall have treads at least 7 inches in width at a point one foot from the narrow end of the tread, and a uniform riser height of not more than 9½ inches.

(8) SPACES BENEATH STAIRS AND RAMPS. Spaces beneath the steps, stairs, ramps, landings and platforms which are within a vertical enclosure under s. Comm 51.02 (11) may not be used for any other purpose, unless that space is separated from the enclosure by the same degree of fire resistive construction required for the enclosure.

(b) Spaces beneath steps, stairs, ramps, landings and platforms which provide a means of egress, but not enclosed under s. Comm 51.02 (11), may not be used for any other purpose, unless:

1. The space is separated from steps, ramps, landings and platforms by at least one hour fire resistive construction; or

2. The space and the steps, ramps, landings and platforms are all contained within an individual living unit under the scope of ch. Comm 57.

History: 1-2-56; am. (2); (2) (a); (2) (b); Register, June, 1956, No. 6, eff. 7-1-56; r. and recr. Register, September, 1959, No. 45, eff. 10-1-59; r. (4) (b), renum. (c) to be (b), and cr. (5), Register, February, 1971, No. 182, eff. 3-1-71; am. (2) (a), Regis-

ter, September, 1973, No. 213, eff. 10-1-73; r. and recr. Register, December, 1974, No. 228, eff. 1-1-75; am. (4) (a) and cr. (10), Register, December, 1977, No. 264, eff. 1-1-78; cr. (7) (a), Register, December, 1978, No. 276, eff. 1-1-79; r. (5) to (7), renum. (8) to (10) to be (5) to (7) and am. (7), Register, January, 1980, No. 289, eff. 2-1-80; r. and recr. (1), am. (2), (3) (a) and (5), renum. (3) (b) to be (3) (b) 1. and am., cr. (3) (b) 2., (4) (f) and (g), Register, August, 1985, No. 356, eff. 1-1-86; renum. (3) (b) 1. to be (3) (b), r. (3) (b) 2., am. (4) (a) (intro.), (d) and (7), cr. (8), Register, February, 1991, No. 423, eff. 4-1-91; am. (3) (a), cr. (3) (c) and (4) (a) 2., renum. (4) (a) to be (4) (a) 1. and am., r. (5) (c), Register, January, 1994, No. 457, eff. 2-1-94; r. and recr. (4) (f), Register, November, 1994, No. 467, eff. 12-1-94; am. (4) (a) 1., Register, December, 1997, No. 504, eff. 1-1-98; correction in (4) (d) made under s. 13.93 (2m) (b) 7., Stats., Register, November, 1999, No. 527.

Comm 51.161 Handrails. (1) WHERE REQUIRED. Handrails shall be provided in all of the following conditions unless otherwise specified in the occupancy chapters of this code.

(a) On either side for all interior stairways of more than 3 risers and for all ramps overcoming a change in elevation of more than 24 inches.

(b) On the open side of any stairway with more than 3 risers and on the open side of any ramp overcoming a change in elevation of more than 24 inches.

(c) On both sides of interior stairways or ramps 5 feet or more in width.

(d) To divide interior stairways or ramps more than 8 feet wide into widths at least 3 feet 8 inches but less than 8 feet.

(e) On both sides of exterior stairways with more than 3 risers and on both sides of exterior ramps overcoming a change of elevation of more than 24 inches, either of which are an integral part of the building.

(f) To divide exterior stairways or ramps, either of which are an integral part of the building and more than 25 feet wide into approximately equal widths not less than 3 feet 8 inches but not greater than 25 feet.

(g) The requirements specified in pars. (a) to (f) do not apply to ramps having a slope less than 1:20.

Note: See ch. comm 69 for handrail requirements for ramps used to provide barrier free access.

(h) On fire escapes as specified in s. Comm 51.20 (8).

(2) LOADING. All handrails shall be designed and constructed to withstand a load of 200 pounds applied in any direction at any point.

(3) HEIGHT. The top of the handrail gripping surface shall be mounted between 34 inches and 38 inches above the nosing of the treads on stairways or above the surface of ramps.

Note: See s. Comm 51.20 (8) for handrail requirements for fire escapes.

(4) CONTINUITY AND EXTENSIONS. (a) Except as provided in par. (b), handrails shall be continuous for the full length of the stairway or ramp and one handrail shall extend at least 12 inches beyond the top and bottom riser or ramp end and shall not constitute a projecting hazard.

(b) 1. Handrails not required for barrier-free design construction on assembly seating facilities need not comply with the 12 inch extension requirement.

2. Handrails on stairs located within individual living units need not comply with the requirements of par. (a).

(5) CLEARANCE. Handrails shall provide a clearance of at least 1½ inches between the handrail and the wall to which it is fastened.

(6) OPENINGS BELOW TOP RAIL. (a) Handrails protecting the open sides of stairways and ramps shall have intermediate rails or an ornamental pattern designed to prevent the passage of an object with a diameter larger than 6 inches, except in adult detention or correctional facilities, factory or warehouse occupancies the clear distance between intermediate rails measured at right angles to the rails may not exceed 21 inches.

(b) Handrails protecting the open sides of stairways and ramps not subject to use by children (i.e., waste water treatment plants, foundries, tanneries and other industrial occupancies) shall be provided with an intermediate rail at mid height or equivalent.

(7) HANDGRIP DIMENSIONS. (a) Except as specified in par. (b), handrails serving stairways or ramps shall have a circular cross-

section with an outside diameter of at least 1¼ inches and not greater than 2 inches. Handrails shall be graspable along the entire length.

(b) Any other shape handrail with a perimeter of at least 4 inches, but not greater than 6¼ inches and with the largest cross-sectional dimension not exceeding 2¼ inches may be used.

History: Cr. Register, January, 1980, No. 289, eff. 2-1-80; am. (4), Register, December, 1981, No. 312, eff. 1-1-82; am. (1) (a) to (g), renum. (4) (b) to be (4) (b) 1., cr. (4) (b) 2., Register, August, 1985, No. 356, eff. 1-1-86; am. (1) (a), r. and recr. (6) (a), cr. (7), Register, February, 1991, No. 423, 4-1-91; am. (3), Register, January, 1994, No. 457, eff. 2-1-94; r. and recr. (7) (b), Register, April, 1998, No. 508, eff. 5-1-98.

Comm 51.162 Guardrails. (1) WHERE REQUIRED. Guardrails shall be provided in all of the following conditions unless otherwise specified in the occupancy chapters of this code:

(a) On the open side of elevated platforms, landings, walks, balconies and mezzanines which are more than 24 inches in height;

(b) On assembly seating facilities as specified in s. Comm 62.77;

(c) On open parking structures as specified in s. Comm 62.28 and as indicated in sub. (5); and

(d) On openings through floors and roofs.

(2) EXEMPT LOCATIONS. Guardrails need not be provided:

(a) On the loading side of loading docks;

(b) On the auditorium side of a stage or enclosed platform; and

(c) Around floor pits, openings or depressions for manufacturing areas and processing areas where guardrails would interfere with the operations or functions of the areas.

Note: Federal OSHA also prescribes requirements concerning the guarding of floor openings under 29 CFR 1910.

(3) LOADING. (a) Except as provided in par. (b), all guardrails shall be designed and constructed to withstand a load of at least 200 pounds applied in any direction at any point.

(b) All guardrails on assembly seating facilities shall be designed and constructed to withstand a vertical and horizontal load of 50 pounds per linear foot. Loads need not be applied simultaneously.

(4) HEIGHT. Guardrails shall not be less than 3 feet 6 inches in height.

(a) **Exception.** Guardrails within an individual living unit, or on an exterior appurtenance accessible only to the occupant of that unit, may be 36 inches in height.

(b) **Exception.** Guardrails on a balcony immediately in front of the first row of fixed seating and which are not at the end of an aisle may be 30 inches in height.

(5) OPENINGS BELOW TOP RAIL. (a) Guardrails protecting the open sides of elevated platforms, walks, balconies, and mezzanines shall have intermediate rails or an ornamental pattern designed to prevent the passage of an object with a diameter larger than 6 inches, except in adult detention or correctional facilities, factory or warehouse occupancies the clear distance between intermediate rails measured at right angles to the rails may not exceed 21 inches.

(b) Guardrails in areas not subject to use by children shall be provided with an intermediate rail at mid height or equivalent.

History: Cr. Register, January, 1980, No. 289, eff. 2-1-80; am. (1) (b), (3) and (4) (b), Register, December, 1981, No. 312, eff. 1-1-82; r. and recr. (2) and (5) (a), Register, February, 1991, No. 423, eff. 4-1-91; am. (4) (a), Register, January, 1994, No. 457, eff. 2-1-94.

Comm 51.164 Headroom. (1) GENERAL. Except as provided in sub. (2), every means of egress shall be provided with a headroom clearance of not less than 6 feet 8 inches. In stairways, the clearance shall be 7 feet 0 inches established by measuring vertically from the edge of the tread nosing to the ceiling or soffit above the tread nosing.

(2) EXCEPTION. The headroom clearance for public stairways in apartments and townhouses may be reduced to not less than 6 feet 8 inches.

Note: See s. Comm 57.07 (3) for requirements pertaining to stairways within individual living units.

Note: See ch. Comm 18, ASME A17.1 101.4 for 84-inch headroom requirement in elevator machine rooms, and s. Comm 18.85 (2) for 78-inch headroom requirement in limited-use, limited-application elevator machine rooms.

History: Cr. Register, January, 1980, No. 289, eff. 2-1-80; am. Register, December, 1983, No. 336, eff. 1-1-84.

Comm 51.165 Stairway identification. All stairways serving 4 or more stories shall have each floor level or story identified on the stair side as to its name or number with a permanent sign having letters or characters at least 2 inches in height.

History: Cr. Register, December, 1981, No. 312, eff. 1-1-82.

Comm 51.166 Stairway discharge. Where a stairway from the level below the exit discharge and a stairway from an upper floor terminate at the same exit discharge level, an approved barrier shall be provided to prevent persons from continuing down one or more full floor levels below the exit discharge level unless the exit discharge level has a vision panel to the outside or is otherwise made readily apparent.

History: Cr. Register, December, 1981, No. 312, eff. 1-1-82; am. Register, October, 1982, No. 322, eff. 11-1-82.

Comm 51.167 Exiting through areas of hazard.

(1) GENERAL. Except as provided in subs. (2) and (3), exit access shall be so arranged that it will not be necessary to travel through any area of hazard in order to reach the exit.

(2) GARAGES. (a) Occupancies within the scope of ch. Comm 54 may exit through storage garages.

(b) Occupancies within the scope of ch. Comm 54 may not exit through repair garages.

(c) Occupancies within the scope of chs. Comm 55 to 62 may not exit through a storage or repair garage.

(3) KITCHENS. (a) Exiting through a kitchen within an individual living unit is permitted.

(b) Exiting through kitchens equipped with residential-type appliances in areas such as but not limited to employee lounges, activity rooms and similar areas is permitted provided the kitchen is not used for commercial purposes.

(c) Exiting through kitchens of restaurants and similar commercial operations or kitchens equipped with commercial-type appliances is prohibited.

History: Cr. Register, December, 1981, No. 312, eff. 1-1-82; am. Register, October, 1982, No. 322, eff. 11-1-82.

Comm 51.17 Smokeproof stair tower. (1) A smokeproof stair tower shall be an enclosed stairway which is entirely cut off from the building and which is reached by means of open balconies or platforms. The stairways, landings, platforms and balconies shall be of noncombustible material throughout. The enclosing walls shall be of not less than 4-hour fire-resistive construction, and the floors and ceilings of not less than 2-hour fire-resistive construction as specified in s. Comm 51.04.

(2) The doors leading from the buildings to the balconies and from the balconies to the stairways shall be fire-resistive doors, and all openings within 10 feet of any building shall be protected with fire-resistive windows for moderate fire exposure, or fire-resistive doors as specified in s. Comm 51.047.

(3) Each balcony shall be open on at least one side, with a railing not less than 3 feet 6 inches high on all open sides.

History: 1-2-56; am. Register, December, 1962, No. 84, eff. 1-1-63; am. (1) and (2), Register, February, 1971, No. 182, eff. 7-1-71; r. and recr. (1) and (2) eff. 8-1-71 and exp. 1-1-72, and cr. (1) and (2) eff. 1-1-72, Register, July, 1971, No. 187; am. (2), Register, June, 1972, No. 198, eff. 7-1-72.

Comm 51.18 Interior enclosed stairway. (1) GENERAL. An interior enclosed stairway shall be separated from other areas of the building by fire-resistive rated construction as specified in ss. Comm 51.04 to 51.049 with the hourly ratings as specified in Table 51.03-A.

(2) EXTENT OF ENCLOSURE. (a) The enclosure shall include at each floor level a portion of the floor which will be at least as wide as the stairway.

(b) The enclosure shall provide uninterrupted passage from the uppermost floor to an outside door without leaving the enclosure.

(c) The enclosure shall also include any passageway, if provided, on the floor of exit discharge leading from the stairway to the exit discharge, so as to afford uninterrupted passage from the uppermost floor to the exit discharge, without leaving the enclosure.

(3) OPENINGS IN THE ENCLOSURE. Openings in the stairway enclosure shall be limited to exit doors serving public passageways or corridors or serving floors occupied by a single tenant.

Note: See ch. Comm 18 for additional requirements pertaining to the location of elevator equipment room access doors.

(4) PROTECTION OF OPENINGS. (a) All openings for doors shall be protected by fire-rated door assemblies as specified in s. Comm 51.047.

(b) If windows are provided in the enclosure, the window openings shall be protected by fixed fire-rated window assemblies as specified in s. Comm 51.048, except in outside walls.

History: 1-2-56; am. (1) and (3), Register, February, 1971, No. 182, eff. 7-1-71; r. and recr. (1) and (3), eff. 8-1-71 and exp. 1-1-72, and cr. (1) and (3), eff. 1-1-72, Register, July, 1971, No. 187; r. and recr. (1), Register, June, 1972, No. 198, eff. 1-1-73; am. (3), Register, December, 1975, No. 240, eff. 1-1-76; am. (2), Register, January, 1980, No. 289, eff. 2-1-80; r. and recr., Register, December, 1981, No. 312, eff. 1-1-82.

Comm 51.19 Horizontal exit. (1) GENERAL. A horizontal exit shall consist of one or more openings through an occupancy separation; a 2-hour fire-rated separation wall extending from the basement or lowest floor to the underside of the roof deck or of one or more bridges or balconies connecting 2 buildings or parts of buildings entirely separated by occupancy separations as described in s. Comm 51.08.

(2) PROTECTION OF OPENINGS. Openings used in connection with horizontal exits shall be protected by fire-resistive doors as specified in s. Comm 51.047.

(a) Doors serving as required exits shall be standard exit doors and shall swing in the direction of exit travel. Where a horizontal exit serves spaces on both sides of the wall, there shall be adjacent doorways equipped with doors which swing in opposite directions.

1. 'Exceptions.' a. The swing of the exit door may comply with the exceptions permitted in the occupancy chapters of this code.

(b) Approved illuminated exit signs shall be provided to indicate the horizontal exit.

(c) Such doors shall be kept unlocked, unobstructed, provided with a self-closing device and normally be kept closed.

1. 'Exception.' Doors protecting openings used in connection with horizontal exits may be left opened if equipped with an automatic closing device actuated by smoke density or products of combustion other than heat.

Note: See NFPA 72 for requirements on door closer initiating devices.

(3) RAMP SLOPE. Where there is a difference of elevation between connected areas, the difference shall be overcome by a ramp with a slope of not more than one foot in 8.

Note: See ch. Comm 69 for ramp requirements for accessibility.

(4) PROJECTION OF ADJACENT OPENINGS. All doors and windows within 10 feet of any balcony or bridge shall be fire-resistive doors or fire-resistive windows as specified in ss. Comm 51.047 and 51.048.

History: 1-2-56; am. (2) and (4), Register, February, 1971, No. 182, eff. 7-1-71; r. and recr. (2) and (4) eff. 8-1-71 and exp. 1-1-72, and cr. (2) and (4) eff. 1-1-72, Register, July, 1971, No. 187; am. (4) Register, June, 1972, No. 198, eff. 7-1-72; am. (4), Register, December, 1975, No. 240, eff. 1-1-76; r. and recr. Register, December, 1978, No. 276, eff. 1-1-79; am. (1) and (3), r. (2) (a) 1. a., renun. (2) (a) 1. b. to (2) (a) 1. a., Register, January, 1980, No. 289, eff. 2-1-80.

Comm 51.20 Fire escapes. (1) GENERAL. (a) Location. Fire escapes shall lead directly to a street, alley or open court connected with a street.

(b) Adjacent openings. All openings within 6 feet horizontally of any tread, landing or platform of the fire escape shall be protected with a fire-resistive rated door assembly complying with

s. Comm 51.047 or a fire window assembly complying with s. Comm 51.048 as follows:

1. Buildings of 3 stories or less, shall use either a door or window assembly having a minimum fire-resistive rating of 3/4 hour.

2. Buildings of more than 3 stories shall use a door having a minimum fire-resistive rating of 1 1/2 hours.

(2) EXITS TO FIRE ESCAPES. Every fire escape shall be accessible from a public passageway or shall be directly accessible from each occupied room. Exits to fire escapes shall be standard exit doors as specified in s. Comm 51.15, except that doors to "A" fire escapes may be not less than 2 feet 6 inches wide.

(3) DESIGN AND FABRICATION. Each part of every fire escape (except counterweights for balanced stairways) shall be designed and constructed to carry a live load of 100 pounds per square foot of horizontal area over the entire fire escape. Each part of every fire escape shall be designed and constructed in accordance with the requirements of s. Comm 53.50, except that the unit stresses therein specified shall be reduced by one-fourth. The minimum sections and sizes specified below shall be increased whenever necessary so that under full load the allowable unit stresses will not be exceeded.

(a) No other material than wrought iron, soft steel or medium steel shall be used for any part of a fire escape, except for weights, separators and ornaments. No bar material less than 1/4 inch thick shall be used in the construction of any fire escape, except for separators, ornaments, structural shapes over 3 inches and rigidly built up treads and platforms of approved design. In the fabrication of a fire escape, all connections or joints shall be made by riveting, bolting or welding in an approved manner. All bolts or rivets, except for ornamental work, shall be not less than 3/8 inch in diameter.

(4) PLATFORMS. Each platform on an "A" fire escape shall be at least 28 inches wide; each platform on a "B" fire escape shall be at least 3 feet 4 inches wide. Such widths shall be the clear distance between stringers, measuring at the narrowest point. Each platform shall extend at least 4 inches beyond the jambs of exit opening. The above minimum widths and lengths shall be increased, wherever necessary, so that no exit door or window will, when open, block any part of the required width of the fire escape. Every platform shall consist of either:

(a) Flat bars on edge, not less than 1 x 1/4 inch, but not less than 1 1/4 x 1/4 inch where bolts and separators are used except that platforms and treads constructed of flat bars on edge may be made of material 3/16 inch in thickness provided the material is galvanized after fabrication. Bars shall not be spaced more than 1 1/4 inches, center to center.

(b) 1/2 inch or 5/8 inch square bars with sharp edge up, not more than 1 1/2 inches, center to center.

(c) 5/8 inch round bars, not more than 1 1/2 inches, center to center.

(d) Platform and treads may be solid if covered by a roof.

(e) The platform frame shall consist of not less than 2 x 3/8 inch flat bars on edge or equivalent, provided the brackets are not more than 4 feet apart. If brackets are more than 4 feet apart, the frame shall be correspondingly stronger and stiffer. Every platform wider than 30 inches, if made of square or round bars, shall have a third frame bar through the center; if made of flat bars, the platform shall have separators and bolts through the center. Frame bars shall not project more than 1/4 inch above platform bars, except around the outside of platform.

(f) There shall be a platform at each story above the first, and intermediate platforms if floors are more than 18 feet apart vertically.

(g) Platforms shall not be more than 8 inches below the door sill.

(5) BRACKETS. Brackets for a 28 inch or 30 inch platform, when spaced not more than 4 feet apart, shall be made of not less than 7/8 inch square bars or 1 1/2 x 1 1/2 x 1/4 inch angles; such bars

or angles shall be larger if the platform is wider or if the brackets are farther apart. Each bracket shall be fastened at the top to the wall by a through bolt (at least $\frac{7}{8}$ inch diameter), nut, and washer (at least 4 inch diameter). The slope of the lower bracket bar shall be not less than 30° with the horizontal. The lower bar shall have a washer or shoulder to give sufficient bearing against the wall.

(a) The strength of the wall to which brackets are to be attached shall be carefully considered in determining the spacing, shape and inside connection of brackets, so that under full load the wall will not be unduly strained. Where it is necessary to install brackets adjacent to wall openings they shall be located at a suitable distance therefrom, or the wall shall be properly reinforced.

(6) STAIRWAYS. (a) Each stairway of an "A" fire escape shall be at least 24 inches wide between stringers; such stairway shall have a uniform rise of not more than 8 inches and a uniform run of not less than 8 inches.

(b) Each stairway of a "B" fire escape shall be at least 3 feet 4 inches wide between stringers; such stairway shall have a uniform rise of not more than 8 inches, and a uniform run of not less than 9 inches.

1. The rise is the vertical distance from the extreme edge of any step to the corresponding extreme edge of the next step. The run is the horizontal distance between the same points.

(c) Stairway stringers shall consist of either:

1. A 5 inch channel or larger.
2. Two angles $2 \times 2 \times \frac{1}{4}$ inch or larger.
3. Two flat bars $2 \times \frac{3}{8}$ inch or larger.
4. One flat bar $6 \times \frac{1}{4}$ inch or larger.

5. If 2 angles or 2 flat bars are used, they shall be properly tied together by lattice bars, vertical as well as horizontal. If flat bars are used, every stairway of more than 10 risers shall have lateral bracing. The connection of stringers to platform, at top and bottom, shall be at least equal in strength to the stringers and shall safely carry the full live and dead loads. If stringers are carried by intermediate brackets, the stringers shall have a horizontal bearing on the brackets and shall be properly and securely connected thereto.

6. Treads shall consist of either flat or square bars, (not round), of the size and spacing specified for platforms. An "A" tread shall consist of at least 6 square bars, or 7 flat bars. A "B" tread shall consist of at least 7 square bars, or 8 flat bars. A "B" tread made of flat bars shall have separators and bolt through the center. A "B" tread made of square bars shall be trussed.

7. Treads and platforms may be solid if covered by a roof.

(7) BALANCED STAIRWAY. All "B" fire escapes, and all fire escapes on schools, theaters, assembly halls, hospitals, nursing homes, residential care institutions, group foster homes, and homes for the elderly either shall reach to the ground or shall have a balanced stairway reaching to the ground. "A" fire escapes which are not on schools, theaters, assembly halls, hospitals, nursing homes, residential care institutions, group foster homes and homes for the elderly may terminate in a platform at least 3 feet long, located not more than 10 feet above the ground and does not serve more than 8 persons.

(8) RAILINGS. A railing at least 42 inches in height, measuring vertically from the floor of the platform, shall be provided on all open sides of platforms. Railings at least 36 inches in height, measuring vertically from the nose of the treads, shall be provided on the open sides of all stairways and on both sides of balanced stairways. Either a railing or a handrail fastened to the wall shall be provided on each side of all "B" fire escape stairways. Railings on fire escapes subject to use by children shall have intermediate rails or an ornamental pattern designed to prevent the passage of an object with a diameter larger than 6 inches. Railings on fire escapes not subject to use by children shall be provided with 2 uniformly spaced intermediate rails.

(a) Every railing shall have posts, not more than 5 feet apart made of not less than $1\frac{1}{2} \times 1\frac{1}{2} \times \frac{1}{4}$ inch angles or tees, or $1\frac{1}{4}$ inch pipe; top rail not less than $1\frac{1}{4} \times 1\frac{1}{4} \times \frac{1}{4}$ inch angle or equivalent; center rail not less than $1\frac{1}{4} \times \frac{5}{16}$ flat bar or equivalent. All connections shall be such as to make the railing stiff; 2 bolts ($\frac{3}{8}$ inch or larger) shall be used at the foot of each post wherever possible, or at least one $\frac{1}{2}$ inch bolt shall be used. Railing shall be continuous. No projections on the inside of the railing shall be permitted. Where a railing returns to the wall, it shall be fastened thereto with a through bolt (at least $\frac{5}{8}$ inch diameter), nut, and washer; or (in reinforced concrete) with an approved insert; or the railing shall be made equally secure with a diagonal brace extending at least 3 feet horizontally and 3 feet vertically.

(b) All outside railings which are more than 60 feet above grade shall be at least 6 feet high, measuring vertically from floor of platform or from nose of step. Such railings shall be of special design approved by the department, having not less than 4 longitudinal rails, and vertical lattice bars not more than 8 inches apart, and proper stiffening braces or brackets.

(9) LADDER TO ROOF. Every fire escape which extends higher than the second floor shall be provided with a ladder leading from the upper platform to the roof, unless the fire escape stairway leads to the roof. The ladder shall have stringers not less than $1\frac{1}{4}$ inch pipe, or not less than $2 \times \frac{3}{8}$ inch flat bars, at least 16 inches apart in the clear. The rungs shall be not less than $\frac{1}{2}$ inch square or $\frac{3}{4}$ inch round bars, 12 inches center to center. The stringers shall be securely tied together at intervals no greater than every fifth rung. The stringers of each ladder shall extend not less than $3\frac{1}{2}$ feet above the roof coping and return to within 2 feet of the roof, with the top rung of the ladder level with the coping.

(10) OTHER TYPES OF FIRE ESCAPES. Sliding or chute fire escapes may be used, upon the approval of the department of industry, labor and human relations, in place of "A" or "B" fire escapes. Every sliding fire escape shall be provided with a ladder constructed as in sub. (9), extending from 5 feet above grade, to 4 feet above the roof coping.

History: 1-2-56; am. Register, December, 1962, No. 84, eff. 1-1-63; am. (1) (a), Register, February, 1971, No. 182, eff. 7-1-71; am. (7), Register, February, 1971, No. 182, eff. 3-1-71; r. and recr. 51.20 (1) (a) eff. 8-1-71 and exp. 1-1-72 and cr. (1) (a) eff. 1-1-72; Register, July, 1971, No. 187; am. (1) (a), Register, June, 1972, No. 198, eff. 7-1-72; am. (3) (intro. par.), Register, December, 1974, No. 228, eff. 1-1-75; am. (1) (a), Register, December, 1975, No. 240, eff. 1-1-76; am. (8) (intro.), Register, January, 1980, No. 289, eff. 2-1-80; am. (8) (b), Register, December, 1981, No. 312, eff. 1-1-82; am. (9), Register, February, 1991, No. 423, eff. 4-1-91; am. (8) (intro.), Register, January, 1994, No. 457, eff. 2-1-94; r. and recr. (1), Register, March, 2000, No. 531, eff. 4-1-00.

Comm 51.21 Standpipe and hose systems. (1) All standpipe and hose systems shall meet the requirements of NFPA 14 and the requirements of this section.

(2) CLASSES OF SERVICE. (a) *Class I—Fire department standpipes.* For use by fire departments and those trained in handling heavy fire streams from a $2\frac{1}{2}$ -inch hose.

(b) *Class II—First-aid standpipes.* For use primarily by occupants of a building until the arrival of the fire department ($1\frac{1}{2}$ -inch hose).

(c) *Class III—Combination fire department and first-aid standpipes.* For use by either fire departments and those trained in handling heavy hose streams or by the building occupants.

(d) *Dry standpipes.* For use by fire departments.

(3) CLASS I—FIRE DEPARTMENT STANDPIPES. (a) *Where required.* Fire department standpipes shall be provided for all buildings exceeding 60 feet in height.

1. Required standpipes shall be installed as construction progresses, to make them available for fire department use in the topmost floor constructed. Temporary standpipes may be provided in place of permanent standpipes during the period of construction when approved by the local fire department.

(b) *Number of standpipes.* Standpipes shall be sufficient in number so that any part of every floor area can be reached within

30 feet by a nozzle attached to 100 feet of hose connected to the standpipe in an unsprinklered building and 150 feet of hose in a sprinklered building.

(c) *Cross connections.* When 2 or more standpipes are required, they shall be cross connected and equipped with individual control valves. All control valves shall be of an approved indicating type valve. The valves shall be located so that the water supply to any standpipe riser can be shut off without interrupting the water supply to the remaining standpipes and be readily accessible to the fire department.

(d) *Location of outlets.* Hose outlets shall be located in stairway enclosures. Where stairways are not enclosed, outlets shall be at the inside of outside walls, within one foot of a smokeproof tower, interior stairway or fire escape. In buildings containing large interior areas, standpipes may be located at accessible interior locations.

(e) *Protection of standpipes.* Standpipes shall be protected against mechanical and fire damage. Dry standpipes shall be visible for inspection and not concealed.

Note: It is not the intent of this section to require standpipes to be protected with an hourly rated fire protection.

(f) *Size.* No required standpipe shall be less than 4 inches in diameter, and not less than 6 inches in diameter for standpipes in excess of 100 feet in height unless the building is completely sprinklered and the standpipe system is hydraulically designed in accordance with the requirements of sub. (6).

(g) *Hose valves and connections.* An approved 2½-inch hose-connection valve shall be located at each story, not less than 3 feet nor more than 6 feet above the floor level. Hose-connection valves shall be equipped with a tight-fitting cap on a chain and having lugs for a spanner wrench. When the building is completely sprinklered, and class II service is omitted, each standpipe outlet location shall be equipped with a 2½-inch hose valve, a 2½-inch by 1½-inch reducer, and a cap with an attached chain.

(h) *Hose threads.* All threads on hose connections shall be of national standard dimensions.

Note: Section 213.15, Stats., requires that all hose connections be fitted with the national standard hose threads adopted by the national fire protection association.

(j) *Automatic water supply.* An automatic water supply for a wet standpipe system shall be designed to provide not less than the following capacity from top outlets at not less than 65 psi flowing pressure for a period of 30 minutes; 500 gpm for a single standpipe; 750 gpm for 2 interconnected standpipes; 1,000 gpm for larger systems. Any of the following supplies will be acceptable:

1. Public waterworks system where pressure and discharge capacity are adequate;
2. Approved automatic fire pump (or pumps);
3. Pressure tank;
4. Gravity tank;
5. Approved manually controlled fire pump operated by remote control devices at each hose outlet; or
6. Reservoirs.

(k) *Dry standpipes.* If only one standpipe is required, a dry standpipe may be used. A dry standpipe shall be limited to a single riser and shall not exceed 150 feet in height.

(4) **CLASS II—FIRST-AID STANDPIPES.** (a) *Where required.* First-aid standpipes shall be provided as required by the occupancy chapters of this code.

(b) *Number and location.* Standpipes shall be sufficient in number so that any part of every floor area, including basements, can be reached within 30 feet by a nozzle attached to not more than 100 feet of hose connected to a standpipe.

1. Hose outlets shall be located in occupied areas and preferably in corridors or at interior columns.

(c) *Size.* No required standpipe shall be less than 2 inches in diameter for buildings 4 or less stories or 50 feet in height, and not

less than 2½ inches in diameter for buildings exceeding 4 stories or 50 feet in height.

(d) *Hose valves and connections.* An approved 1½-inch hose valve shall be located not more than 5 feet above the floor level. Where the static pressure at any standpipe hose outlet exceeds 100 psi, an approved device shall be installed at the outlet to reduce the pressure with the required flow at the outlet to not more than 100 psi.

(e) *Hoses.* Not more than 100 feet of hose shall be attached to each outlet. Hoses shall be of an approved type, 1½-inches in diameter, with ½-inch solid stream or combination nozzle attached, and shall be located in approved cabinets, racks or reels. In locations where the use of a solid stream may contribute to the spread of fire by scattering the burning material or where the existence of flammable liquids make the use of spray stream desirable, combination nozzles which give a spray or a solid stream shall be provided instead of ½-inch nozzles.

(f) *Water supply.* An automatic water supply shall be provided. The water supply shall be designed for 100 gpm for 30 minutes with 65 psi flowing pressure at the top outlet. The water supply may be from a city connection, gravity tank, pressure tank or pump.

Note: The department will permit the domestic water supply system to serve class II standpipes.

Note: The department will permit pumps, other than fire pumps, provided the water supply meets the requirements of sub. (4) (f).

(5) **CLASS III—COMBINED FIRE DEPARTMENT AND FIRST-AID STANDPIPES.** (a) *Where permitted.* The features of class I and II service may be combined in a single system if served by an acceptable automatic water supply conforming to the requirements of sub. (3) (j).

(b) *Requirements.* Class III standpipes shall conform to the requirements of class I service except that 1½-inch outlets with a hose and 2½-inch outlets shall be provided on each floor and shall be installed to the requirements of the respective classes of service.

(6) **DRY STANDPIPES.** (a) *Where required.* Dry standpipes shall be provided as required by chs. Comm 54 to 62.

Note: See ss. Comm 54.15, 55.33, 56.20, 57.15 and 62.30.

(b) *Number and location.* Required dry standpipes shall be provided in each stair enclosure.

(c) *Hose valves and connections.* 1. Required dry standpipes shall be provided with approved 2½-inch valve hose connections at each floor level with one connection in the stair tower and one immediately outside.

2. Required dry standpipes with a fire department siamese connection greater than 50 feet to a street shall be interconnected to a standpipe system with the connection 50 feet or less to a street.

(d) *Miscellaneous requirements.* Dry standpipes shall conform to the requirements specified in sub. (3) (e) to (i).

(7) **COMBINED AUTOMATIC SPRINKLER AND STANDPIPE SYSTEM.** (a) *Definition.* A combined system is a system where the vertical water piping serves both the automatic sprinkler system and the 2½-inch hose outlets of the standpipes used by the fire department. The combined system shall comply with the automatic sprinkler requirements of s. Comm 51.23 and the standpipe and hose requirements of s. Comm 51.21.

(b) *Water supply and riser size.* The minimum water supply and riser size for a combined system shall comply with the requirements of sub. (3) (f) and (j), except the minimum water supply for a combined system for a completely sprinklered, light hazard occupancy building shall be 500 gallons per minute. When the building is completely sprinklered, the risers may be sized by hydraulic calculations.

Note: NFPA 13 defines light hazard occupancies as occupancies where the quantity and/or combustibility of contents is low and fires with relatively low rates of heat release are expected, such as: churches; clubs; educational; hospitals; institutional; libraries, except large stack rooms; museums; nursing or convalescent homes;

offices, including data processing; residential; restaurant seating areas; theaters and auditoriums, excluding stages and prosceniums; and unused attics.

(c) **Connections.** Each connection from a vertical riser of a combined system shall be provided with an individual control valve of the same size as the outlet.

(8) **MAINTENANCE.** (a) All standpipe and hose systems shall be inspected, tested and maintained in accordance with NFPA 25.

(b) The requirements of par. (a) shall also apply to all systems in existence on the effective date of this section.

(9) **CROSS CONNECTION CONTROL.** (a) A standpipe system connecting to a water supply system or to a municipal water main shall be protected against backflow conditions in accordance with s. Comm 82.41. If a reduced pressure principle backflow preventer or a reduced pressure detector backflow preventer is used as the type of cross connection control, plans for the device shall be submitted for review in accordance with s. Comm 82.20 (1).

(b) Cross connection control devices shall be tested in accordance with s. Comm 82.21 (3).

History: 1-2-56; r. and recr. Register, December, 1976, No. 252, eff. 1-1-77; am. (7), Register, December, 1978, No. 276, eff. 1-1-79; am. (3) (i), Register, June, 1983, No. 330, eff. 7-1-83; emerg. renum. (6) and (7) to be (7) and (8), cr. (2) (d) and (6), eff. 9-6-86; renum. (6) and (7) to be (7) and (8), cr. (2) (d) and (6), Register, November, 1986, No. 371, eff. 12-1-86; cr. (9), Register, January, 1994, No. 457, eff. 2-1-94; am. (9), Register, December, 1996, No. 492, eff. 1-1-97; corrections in (9) made under s. 13.93 (2m) (b) 7., Stats., Register, March, 1997, No. 495; r. and recr. (1) and (8) and r. (3) (i), Register, March, 2000, No. 531, eff. 4-1-00.

Comm 51.22 Fire extinguishers. (1) **GENERAL.** All fire extinguishers shall comply with the provisions of NFPA 10.

(2) **INSTALLATION.** Fire extinguishers as specified in chs. Comm 54 to 62 shall be installed as specified in NFPA No. 10.

(3) **MAINTENANCE AND REPLACEMENT.** (a) 1. All portable fire extinguishers shall be inspected, tested, maintained in operable condition, and replaced as specified in NFPA 10.

2. For fire extinguishers that are first installed after April 1, 2000 and anytime a fire extinguisher is replaced thereafter, the new or replacement extinguisher shall comply with NFPA 10.

(b) The requirements of par. (a) shall also apply to all buildings in existence on the effective date of this section.

Note: NFPA 10 requires portable fire extinguishers that serve commercial cooking equipment, such as deep fat fryers, to be classified as Type K.

Note: See Appendix A for further explanatory material.

History: 1-1-56; am. Register, October, 1967, No. 142, eff. 11-1-67; r. and recr. Register, December, 1981, No. 312, eff. 1-1-82; am. Register, December, 1983, No. 336, eff. 1-1-84; am. Register, March, 1991, No. 423, eff. 4-1-91; am. (1), renum. and am. (3) to be (3) (a) 1. and cr. (3) (a) 2. and (b), Register, March, 2000, No. 531, eff. 4-1-00.

Comm 51.23 Automatic sprinklers. (1) **GENERAL REQUIREMENTS.**

(a) 1. Unless otherwise specifically permitted in this code, where a sprinkler as defined in NFPA 13 is installed to provide fire protection, the system that all sprinklers are connected to shall comply with NFPA 13 or NFPA 13R as applicable, in accordance with the scope of the standard or rule.

2. The water supply for all systems that supply sprinklers shall comply with either sub. (2) or s. Comm 51.236 as applicable.

(b) 1. A sprinkler system shall be so designed, installed and maintained as to provide complete coverage for all portions of the building, except:

2. Sprinkler heads may be omitted within a room dedicated exclusively to electrical equipment provided:

a. The room is separated from other portions of the building by at least one-hour fire-resistive construction;

b. The room is equipped with a smoke detector the activation of which is either audible throughout all the occupied areas of the building or interconnected to a manual fire alarm system; and

c. The storage of combustible materials within the room is prohibited.

Note: See ch. Comm 18 for requirements pertaining to automatic fire sprinkler system protection for elevators.

(c) Reinstallation of used sprinkler heads shall be prohibited.

(d) Approved secondhand devices other than sprinkler heads may be installed by special permission of the department.

Note: The department will accept equipment, materials and devices listed or labeled by Underwriters' Laboratories or approved by Factory Mutual. Other testing laboratories or inspection agencies will be recognized as an approved agency if accepted in writing by the department.

(2) **WATER SUPPLY.** Approved automatic water supplies for the sprinkler system recognized by the department are listed below:

(a) An approved water supply shall be provided for all automatic fire sprinkler systems. Approved water supplies as recognized by the department are listed below:

1. Municipal water system.
2. Gravity or pressure tank.
3. Ground storage reservoir.
4. Natural bodies of water approved by the department
5. Indoor swimming pools as approved by the department.

(b) The design and installation of water supply facilities for gravity tanks, fire pumps, reservoirs or pressure tanks, and underground piping shall conform to NFPA 22, NFPA 20, and NFPA 24.

(c) The connection of an automatic fire sprinkler system to a municipal water main shall be protected against backflow conditions in accordance with s. Comm 82.41.

1. If a reduced pressure principle backflow preventer or a reduced pressure detector backflow preventer is used as the type of cross connection control, plans for the device shall be submitted for review in accordance with s. Comm 82.20 (1).

2. Cross connection control devices shall be tested in accordance with s. Comm 82.21 (3).

(3) **BASEMENT SPRINKLERS.** In buildings where sprinklers are installed in the basement only, sprinklers shall also be provided in all of the following:

- (a) All shafts leading to the story above.
- (b) All elevator hoistways as required by NFPA 13.

(4) **FIRE DEPARTMENT CONNECTION.** Except as provided in s. Comm 57.016 (1) (a), every automatic fire sprinkler system installed in accordance with NFPA 13 shall have an approved fire department connection as specified in NFPA 13. The connection shall be marked "Sprinkler". If standpipes are also supplied by the hose connection, the sign shall read "Standpipe and Automatic Sprinkler". The elevation of the connection shall be not less than 18 inches nor more than 42 inches above the sidewalk or ground. If municipal water is available at the building site, the fire department connection shall be located within 150 feet of a municipal fire hydrant, unless the fire department provides a written statement accepting a specified greater distance.

(5) **SPRINKLER ALARMS.** Every sprinkler system shall be provided with a suitable audible alarm. In all buildings over 60 feet in height, each sprinkler system on each floor shall be equipped with a separate water flow device connected to an alarm system.

(6) **MAINTENANCE.** (a) **Maintenance.** All installed automatic sprinkler systems shall be inspected, tested and maintained in accordance with NFPA 25. Owners or operators shall be responsible for the condition of their sprinkler system and shall maintain the system in good operating condition. Records of inspections, tests, and maintenance as specified in NFPA 25 shall be kept and shall be made available, upon request, to the department or its authorized deputies. The local fire department shall be notified whenever the automatic fire sprinkler system is shut down or impaired and when it is placed back in service. The owner shall arrange for immediate and continual servicing or repair of the automatic fire sprinkler system until it is placed back in operation.

(b) The requirements of par. (a) shall also apply to all systems in existence on the effective date of this section.

(c) The activities relating to the inspection and testing of all existing automatic fire sprinkler systems as required by NFPA 25, including waterflow and alarm tests, shall be conducted at least once a year by a person who holds a credential issued by department as a licensed automatic fire sprinkler contractor, licensed

journeyman automatic fire sprinkler fitter, registered automatic fire sprinkler system apprentice, registered automatic fire sprinkler contractor-maintenance, registered fire sprinkler maintenance fitter or registered automatic fire sprinkler system tester.

Note: Section Comm 51.23 (6) (c) does not limit or preclude other individuals from conducting the daily, weekly, monthly, quarterly or semi-annual activities relating to inspection and testing of automatic fire sprinkler systems required under NFPA 25 and NFPA 72.

Note: See ss. 145.12 (1), 145.15 (4), 145.165 and 145.175, Stats., and ss. Comm 5.50 to 5.55 concerning who may install, modify or maintain automatic fire sprinkler systems.

(7) PARTIAL AUTOMATIC FIRE SPRINKLER SYSTEMS. Partial automatic fire sprinkler systems may be connected without a fire department connection to the domestic water supply system or a first-aid standpipe or a fire department standpipe provided all of the following conditions are satisfied:

(a) The number of sprinkler heads per building does not exceed 20;

(b) The connection is equipped with an approved indicating valve with a monitor or an approved locking device ;

(c) The water pressure and volume is adequate to supply the required flow of the largest number of sprinkler heads in any one of the enclosed areas;

(d) An audible alarm is provided to sound when the system is in operation; and

(e) A pressure gauge and test valve are provided to facilitate the testing and maintenance of the system in accordance with sub. (6).

(9) SYSTEM SUPERVISION AND MONITORING. The height limitations and fire resistive ratings in s. Comm 51.02 (21) and (22) and the unlimited area buildings specified in chs. Comm 54 to 62 shall be permitted only where the automatic fire sprinkler system is equipped with supervised sprinkler system valves or other approved component indicators, such as but not limited to fire pump power indicator or low water level indicator. The supervision function of the automatic fire sprinkler system shall be monitored by a central station, remote, auxiliary or proprietary fire alarm system company.

(10) CROSS CONNECTION CONTROL. The connection of an automatic fire sprinkler system or a partial automatic fire sprinkler system to the domestic water supply system for a building shall be protected against backflow conditions in accordance with s. Comm 82.41.

(a) If a reduced pressure principle backflow preventer or a reduced pressure detector backflow preventer is used as the type of cross connection control, plans for the device shall be submitted for review in accordance with s. Comm 82.20 (1).

(b) Cross connection control devices shall be tested in accordance with s. Comm 82.21 (3).

History: 1-2-56; r. and recr. Register, December, 1974, No. 228, eff. 1-1-75; cr. (7) (a), Register, December, 1976, No. 252, eff. 1-1-77; am. (6), Register, December, 1981, No. 312, eff. 1-1-82; r. and recr. (1), (4), (6) and (7), cr. (8), Register, June, 1983, No. 330, eff. 7-1-83; am. (6), Register, December, 1983, No. 336, eff. 1-1-84; emerg. am. (1) (a), (4) and (6) (a), cr. (9), eff. 9-6-86; am. (1) (a), (4) and (6) (a), cr. (9), Register, November, 1986, No. 371, eff. 12-1-86; am. (1) (a), (2) (b), (4), (6), (7) (c) and (d), r. and recr. (1) (b), cr. (7) (e), Register, March, 1991, No. 423, eff. 4-1-91; am. (4), (6) (a) and (7) (intro.), cr. (2) (c) and (10), Register, January, 1994, No. 457, eff. 2-1-94; cr. (6) (c), Register, October, 1996, No. 490, eff. 11-1-96; am. (2) (c) 1., (10), Register, December, 1996, No. 492, eff. 1-1-97; corrections made under s. 13.93 (2m) (b) 7., Stats., Register, March, 1997, No. 495; r. and recr. (3), Register, April, 1998, No. 508, eff. 5-1-98; r. and recr. (1) (a), am. (2) (a), (b), (6) (a), (b), (7) (b) and r. (8), Register, March, 2000, No. 531, eff. 4-1-00.

Comm 51.235 Alternate fire suppression systems.

(1) Where approved by the department, alternate fire suppression systems may be used in lieu of an automatic fire sprinkler system in areas where the use of water would have limited effect, could create a hazard or could cause unusual damage to property.

(2) Where an alternate fire suppression system is installed, it shall comply with the appropriate national standard as follows:

(a) NFPA 11, Standard for Low-Expansion Foam.

(b) NFPA 11A, Standard for Medium- and High-Expansion Foam Systems.

(c) NFPA 12, Standard on Carbon Dioxide Extinguishing Systems.

(d) NFPA 12A, Standard on Halon 1301 Fire Extinguishing Systems.

(e) NFPA 15, Standard for Water Spray Fixed Systems for Fire Protection.

(f) NFPA 16, Standard for the Installation of Foam-Water Sprinkler and Foam-Water Spray Systems.

(g) NFPA 17, Standard for Dry Chemical Extinguishing Systems.

(h) NFPA 17A, Standard for Wet Chemical Extinguishing Systems.

(i) NFPA 750, Standard on Water Mist Fire Protection Systems.

(j) NFPA 2001, Standard on Clean Agent Fire Extinguishing Systems.

(3) Inspection, testing and maintenance requirements in the standards listed in sub. (2) apply to all new alternate fire suppression systems and to all alternate fire suppression systems in existence on the effective date of this section.

History: Cr. Register, March, 2000, No. 531, eff. 4-1-00.

Comm 51.236 Manual-wet sprinkler system.

(1) WHERE ALLOWED. A manual-wet sprinkler system may not be installed in a building unless all of the following conditions are met:

(a) There is no municipal water system available to serve the property.

(b) There is no provision under this code that requires the building to have an automatic fire sprinkler system.

(c) The municipality where the building is to be located has an adopted ordinance that requires the installation of manual-wet sprinkler systems and requires these systems to meet the provisions of this subsection.

(2) GENERAL REQUIREMENTS. (a) A building protected with a manual-wet sprinkler system shall be considered unsprinklered regarding all other code provisions.

(b) Each manual-wet sprinkler system shall be provided with a fire department connection. The fire department connection shall be installed in an accessible location acceptable to the fire chief.

(c) All above ground system piping throughout the building shall be labeled as a "manual-wet sprinkler system". Labels shall be placed at all of the following locations:

1. On the piping at intervals of not more than 25 feet and at each side where the piping passes through a wall, floor or roof.

2. At the fire department connection.

3. At all valves and hose outlets.

(d) The manual-wet sprinkler system design and installation shall comply with the automatic fire sprinkler system requirements of the adopted edition of NFPA 13, or NFPA 13R as applicable, except that the system comprised of the pilot line, fire department connection and fire department apparatus is considered as the approved water supply for the system.

(e) A manual-wet sprinkler system shall be supplied with water through the fire department connection using fire department apparatus.

(f) The plumbing well, water service and pressure tank shall be of a size and capacity to supply the hydraulically most remote sprinkler with the required waterflow and pressure for a minimum of 10 minutes.

(g) A pilot line shall be connected from the manual-wet sprinkler system to the plumbing water supply system at the well pres-

sure tank. The pilot line shall be of a size that is adequate to supply the hydraulically most remote sprinkler in the system.

(h) The connection of a manual-wet sprinkler system to a plumbing water supply system shall be protected against back-flow conditions in accordance with s. Comm 82.41.

(i) The actuation of any sprinkler in the system shall operate the waterflow indicating device, which shall initiate a fire alarm within the building.

(j) Upon actuation of the building fire alarm, a fire alarm signal shall be sent automatically to the fire department providing fire protection to the building.

(3) **INSTALLER QUALIFICATIONS.** The installation of a manual-wet sprinkler system shall be performed by a licensed individual as specified for the installation of an automatic fire sprinkler system in Ch. Comm 5, Subchapter V.

(4) **INSPECTION, TESTING AND MAINTENANCE.** All manual-wet sprinkler systems shall be inspected, tested and maintained as specified for an automatic fire sprinkler system in NFPA 72, except the quarterly main drain test is not required.

Note: This section does not limit the owners options for providing other means of fire protection. See s. Comm 50.02 for additional information.

History: Cr. Register, March, 2000, No. 531, eff. 4-1-00.

Comm 51.24 Fire alarm systems. All fire alarm systems shall be designed and constructed in accordance with NFPA 72 and the following requirements:

(1) All such alarm systems shall consist of operating stations on each floor of the building, including the basement, with bells, horns, or other approved sounding devices which are effective throughout the building. The system shall be so arranged that the operation of any one station will actuate all alarm devices connected to the system except in the case of a presignal system. Fire alarms shall be readily distinguishable from any other signalling devices used in the building. A system designed for fire alarm and paging service may be used if the design is such that fire alarm signals will have precedence over all others;

(a) In all buildings where a fire alarm system and a complete automatic sprinkler system are required, a water flow detecting device shall be provided to actuate the fire alarm system.

(2) Every fire alarm system shall be electrically operated or activated by non-combustible, nontoxic gas. Electrically operated systems shall be operated on closed circuit current under constant electrical supervision, so arranged that upon a circuit opening and remaining open or in case of a ground or short circuit in the ungrounded conductor, audible trouble signals will be given instantly. Gas-activated systems shall be mechanically supervised and under constant gas pressure, so arranged that in case of a pressure drop an audible trouble signal will be given instantly. Means shall be provided for testing purposes;

(3) (a) Except as provided in par. (b), coded fire alarm systems shall be provided in buildings more than 3 stories in height and the systems shall be so arranged that the code transmitted shall indicate the location and story of the structure in which the signal originated.

(b) 1. The department shall approve non-coded continuous sounding fire alarm systems under constant automatic supervision in apartment buildings.

2. The department shall approve non-coded continuous or march time sounding fire alarm systems with electrically supervised annunciator panels that indicate the location and the story of the structure in which the signal originated.

3. The department shall approve fire alarm and communication systems for high rise construction as specified in s. Comm 52.01 (2) (e).

(4) Operating stations shall be prominently located in an accessible position at all required exit doors and required exit stairways. Operating stations shall be of an approved type and shall be conspicuously identified. All such operating stations shall

be of a type, which after being operated, will indicate that an alarm has been sent therefrom until reset by an authorized means. (Operating stations having a "Break Glass" panel will be acceptable. On coded systems having a device to permanently record the transmission of an alarm, "Open Door" type stations may be used). The fire alarm operating stations shall be mounted not less than 3 feet nor more than 4 feet above the finished floor as measured from the floor to the center of the box;

(5) All alarm systems shall be tested at least once a month and a record of the tests shall be kept;

(6) Existing fire alarm systems that are effective in operation will be accepted if approved by the department;

(7) The gas for operation of non-combustible, non-toxic gas activated fire alarm systems shall be supplied from approved pressure cylinders on the premises. The cylinders shall have sufficient capacity and pressure to properly operate all sounding devices connected to the system for a period of not less than 10 minutes. Cylinders shall be removed for recharging immediately after use and shall be replaced by fully charged cylinders;

(8) Spare cylinders shall be kept on the premises at all times for immediate replacement and separate cylinders for testing shall be incorporated in the system;

(9) Tubing in connection with non-combustible, non-toxic gas activated fire alarm systems shall be installed in rigid metal conduit, flexible metal conduit, or surface metal raceways where subject to mechanical injury. Non-corrosive metallic tubing not less than $\frac{3}{16}$ inch in diameter which will withstand a bursting pressure of not less than 500 pounds per square inch shall be used. The maximum length of $\frac{3}{16}$ inch tubing shall not exceed 300 feet between charged cylinders. All tubing and other component parts shall be installed by skilled workers in accordance with the provisions of this code; and

Note: See Wisconsin State Electrical Code, Volume 2, ch. Comm 16.

(10) **MAINTENANCE.** (a) All fire alarm systems shall be inspected, tested and maintained in accordance with NFPA 72.

(b) The requirements of par. (a) shall also apply to all systems in existence on the effective date of this section.

History: 1-2-56; am. (4) (a), Register, November, 1963, No. 95, eff. 12-1-63; am. Register, August, 1964, No. 104, eff. 9-1-64; r. (10), (11) and (12), Register, December, 1975, No. 240, eff. 1-1-76; cr. (1) (a) and am. intro. and (2), Register, December, 1976, No. 252, eff. 1-1-77; am. (intro.) and (4), r. (3) (a), Register, January, 1980, No. 289, eff. 2-1-80; am. (3) and (6), cr. (10), Register, December, 1981, No. 312, eff. 1-1-82; am. (5), Register, August, 1985, No. 356, eff. 1-1-86; emerg. r. and recr. (3), eff. 9-6-86; r. and recr. (3), Register, November, 1986, No. 371, eff. 12-1-86; am. (2), Register, March, 1991, No. 423, eff. 4-1-91; am. (intro.) and (10), Register, February, 1999, No. 518, eff. 3-1-99; am. (intro.), renum. and am. (1) to be (10) (a) and cr. (10) (b), Register, March, 2000, No. 531, eff. 4-1-00.

Comm 51.245 Smoke detectors. (1) **GENERAL REQUIREMENTS.** All smoke detectors shall be approved by the department and shall comply with the provisions of NFPA 72.

(2) **INSTALLATION.** (a) Unless otherwise specified in this code, all smoke detectors and smoke alarms shall be installed in accordance with NFPA 72.

(b) Smoke detectors installed in ducts shall follow the provisions of NFPA 72 and NFPA 90A.

(3) **MAINTENANCE.** (a) All smoke detectors and system components shall be inspected, tested and maintained in accordance with NFPA 72 and all of the following requirements.

(b) The owner shall be responsible for maintaining the smoke detectors and the smoke detection system in good working order.

(c) Tenants shall be responsible for informing the owner, in writing, of any smoke detector malfunction, including the need for a new battery.

(d) The owner shall have 5 days upon receipt of notice from the tenant to repair or replace the smoke detector or replace the battery.

(e) The owner shall furnish to the tenant written notice of the responsibilities of the tenant and the obligations of the owner regarding smoke detector maintenance.

(f) The requirements of pars. (a) to (e) also apply to all buildings in existence on the effective date of this section.

History: Cr. Register, December, 1981, No. 312, eff. 1-1-82; am. (2) and (3) (c), Register, October, 1982, No. 322, eff. 11-1-82; am. (1) and (2) (a) Register, December, 1983, No. 336, eff. 1-1-84; r. and recr. (3), Register, April, 1990, No. 412, eff. 5-1-90; am. (1) and (2), Register, January, 1994, No. 457, eff. 2-1-94; correction in (2) (b) made under s. 13.93 (2m) (b) 7., Stats., Register, October, 1996, No. 409; am. (1), r. and recr. (2) (a) and (3) (intro.), Register, February, 1999, No. 518, eff. 3-1-99; r. and recr. (2), renum. (3) (a) to (d) to be (3) (b) to (e), renum. and am. (3) (intro.) to be (3) (a) and cr. (3) (f), Register, March, 2000, No. 531, eff. 4-1-00.

Comm 51.25 Incorporation of standards by reference. (1) CONSENT. Pursuant to s. 227.21, Stats., the attorney general and the revisor of statutes have consented to the incorporation by reference of the standards listed in sub. (3).

Note: Copies of the adopted standards are on file in the offices of the department, the secretary of state and the revisor of statutes. Copies of the standards may be purchased through the respective organizations listed in sub. (3).

(2) ALTERNATE STANDARDS. (a) Alternate standards that are equivalent to or more stringent than the standards incorporated by reference in this code may be used in lieu of incorporated standards when approved by the department or if written approval is issued by the department in accordance with par. (b).

(b) 1. a. Upon receipt of a fee and a written request, the department may issue an approval for the use of the alternate standard.

b. The department shall review and make a determination on an application for approval within 40 business days of receipt of all forms, fees, and documents required to complete the review.

2. Determination of approval shall be based on an analysis of the alternate standard and the incorporated standard, prepared by a qualified independent third party or the organization that published the incorporated standard.

3. The department may include specific conditions in issuing an approval, including an expiration date for the approval. Violations of the conditions under which an approval is issued shall constitute a violation of this code.

4. If the department determines that the alternate standard is not equivalent to or more stringent than the standards incorporated by reference, the request for approval shall be denied in writing.

5. The department may revoke an approval for any false statements or misrepresentations of facts on which the approval was based. The department may re-examine an approved alternate standard and issue a revised approval at any time.

6. Fees for review of standards under this paragraph shall be submitted in accordance with ch. Comm 2.

(3) ADOPTION OF STANDARDS. The standards referenced in Tables 51.25-1 to 51.25-21 are hereby incorporated by reference into this chapter.

Note: The tables in this section provide a comprehensive listing of all of the standards adopted by reference in this code. For requirements or limitations in how these standards are to be applied, refer to the code section that requires compliance with the standard.

Table 51.25-1

Standard Reference Number	Title
AA	Aluminum Association 900 19th Street NW Washington, D.C. 20006
SAS-30	Specifications for Aluminum Structures Aluminum Construction Manual, Section 1, 1986.

Table 51.25-2

Standard Reference Number	Title
ACI	American Concrete Institute P.O. Box 19150 Detroit, Michigan 48219
1. 318-89 (Revised 1992)	Building Code Requirements for Reinforced Concrete.
2. 318.1-89 (Revised 1992)	Building Code Requirements for Structural Plain Concrete.
3. 530-88/ASCE 5-88	Building Code Requirements for Masonry Structures.
4. 530.1-88/ASCE 6-88	Specifications for Masonry Structures.

Table 51.25-3

Standard Reference Number	Title
AIA	The American Institute of Architects Order Department 9 Jay Gould Court P.O. Box 753 Waldorf, MD 20601
R673	Guidelines for Construction and Equipment of Hospital and Medical Facilities, 1987 edition.

Table 51.25-4

Standard Reference Number	Title
AISC	American Institute of Steel Construction 400 North Michigan Avenue Chicago, IL 60611
S326	Specification for the Design, Fabrication, and Erection of Structural Steel for Buildings, with Commentary, November 1, 1978, with supplement #1.

Table 51.25-5

Standard Reference Number	Title
AITC	American Institute of Timber Construction 11818 S.E. Mill Plain Blvd., Suite 415 Vancouver, Washington 98684
1. 117-87	Design Standard Specifications for Structural Glued Laminated Timber of Softwood Species
2. 119-85	Standard Specifications for Hardwood Glued Laminated Timber

Table 51.25-6

Standard Reference Number	Title
1. SG-671	Specification for the Design of Cold-formed Steel Structural Members, August, 1986.
2.	Manual For Structural Applications of Steel Cables For Buildings, 1973.

Table 51.25-7

Standard Reference Number	Title
1. Z21.10.1-1993	Gas Water Heaters, Volume I, Storage Water Heaters with Input Ratings of 75,000 Btu per Hour or Less.
2. Z21.10.3-1993	Gas Water Heaters, Volume III, Storage, with Input Ratings Above 75,000 Btu per Hour, Circulating and Instantaneous Water Heaters.
3. Z21.47-1993	Gas-Fired Central Furnaces (except Direct-Vent Central Furnaces).
4. Z83.4-1991, with Z83.4a-1992 Addendum	Direct Gas-Fired Make-up Air Heaters
5. Z83.8-1990, with Z83.8a-1990 and Z83.8b-1992 Addendum	Gas Unit Heaters.
6. Z83.9-1990	Gas-Fired Duct Furnaces
7. Z83.18-1990, with Z83.18a-1991 Addendum	Direct Gas-Fired Industrial Air Heaters.
8. Z97.10-1994	Safety Glazing Materials Used in Buildings.
9. 101-93	ANSI/AAMA Aluminum Poly (Vinyl Chloride) (PVC) Prime Windows and Glass Doors.
10. I.S.2-87	ANSI/NWWDA Wood Windows.
11. I.S.3-88	ANSI/NWWDA Wood Sliding Patio Doors.

Table 51.25-8

Standard Reference Number	Title
1. PS 1-83U.S.	Product Standard for Construction and Industrial Plywood, Revised October, 1988.

Table 51.25-9

Standard Reference Number	Title
1. 81850	Handbook of Fundamentals, 1993.
2. 52-76	Methods of Testing Air-Cleaning Devices Used in General Ventilation for Removing Particulate Matter.
3. 90.1-1989	Energy Efficient Design of New Buildings Except Low Rise Residential Buildings.

Table 51.25-10

Standard Reference Number	Title
1. A6-87d	General requirements for rolled steel plates, shapes, sheet piling and bars for structural use.
2. A36-87	Structural steel.
3. A82-85	Plain steel wire for concrete reinforcement.
4. A116-87	Zinc-coated (galvanized) steel woven wire fence fabric.
5. A153-82 (1987)	Zinc coating (hot-dip) on iron and steel hardware.
6. A615-87a	Deformed and plain billet-steel bars for concrete reinforcement.
7. A616-87	Rail-steel deformed and plain bars for concrete reinforcement.
8. A617-87	Axle-steel deformed and plain bars for concrete reinforcement.
9. C22-83	Gypsum.
10. C25-88	Chemical analysis of limestone, quicklime, and hydrated lime.
11. C34-84	Structural clay load-bearing wall tile.
11a. C36-91	Specification for gypsum wallboard.
12. C39-86	Compressive strength of cylindrical concrete specimens.
13. C42-84a	Obtaining and testing drilled cores and sawed beams of concrete.
14. C50-86	Sampling, inspection, packing, and marking of lime and limestone products.
15. C55-85	Concrete building brick.
16. C56-71 (1986)	Structural clay non-load-bearing tile.
17. C57-57 (1983)	Structural clay floor tile.
18. C62-87	Building brick (solid masonry units made from clay or shale).
19. C67-87	Sampling and testing brick and structural clay tile.
20. C90-85	Hollow load-bearing concrete masonry units.
21. C91-87a	Masonry cement.

Table 51.25-10 - Continued

ASTM	American Society for Testing and Materials 1916 Race Street Philadelphia, Pennsylvania 19103
Standard Reference Number	Title
22. C97-83	Absorption and bulk specific gravity of natural building stone.
23. C99-87	Modulus of rupture of natural building stone.
24. C110-87	Physical testing of quicklime, hydrated lime, and limestone.
25. C140-75 (1980)	Sampling and testing concrete masonry units.
26. C144-87	Aggregate for masonry mortar.
27. C145-75 (1981)	Solid load-bearing concrete masonry units.
28. C150-86	Portland cement.
29. C170-87	Compressive strength of natural building stone.
30. C177-85	Test method for steady-state heat flux measurements and thermal transmission properties by means of the guarded-hot-plate apparatus.
31. C207-79 (1984)	Hydrated lime for masonry purposes.
32. C236-87	Test method for steady-state thermal performance of building assemblies by means of a guarded hot box.
33. C270-88	Mortar for unit masonry.
34. C317-87	Gypsum concrete.
35. C335-84	Test method for steady state heat transfer properties of horizontal pipe insulations.
36. C457-82a	Microscopical determination of air-void content and parameters of the air-void system in hardened concrete.
37. C471-87	Chemical analysis of gypsum and gypsum products.
38. C472-84	Physical testing of gypsum plasters and gypsum concrete.
39. C473-87a	Physical testing of gypsum board products and gypsum lath.
40. C476-83	Grout for reinforced and nonreinforced masonry.
41. C518-85	Test method for steady-state heat flux measurements and thermal transmission properties by means of the heat flow meter apparatus
42. C652-87a	Hollow brick (hollow masonry units made from clay or shale).
43. C666-84	Resistance of concrete to rapid freezing and thawing.

Table 51.25-10 - Continued

ASTM	American Society for Testing and Materials 1916 Race Street Philadelphia, Pennsylvania 19103
Standard Reference Number	Title
44. C952-86	Bond strength of mortar to masonry units.
45. C956-81 (1986)	Installation of cast-in-place reinforced gypsum concrete.
46. C976-82	Test method for thermal performance of building assemblies by means of a calibrated hot box.
47. D245-81	Establishing structural grades and related allowable properties for visually graded lumber.
48. D635-81	Rate of burning and/or extent and time of burning of self-supporting plastics in a horizontal position.
49. D1037-87	Evaluating the properties of wood-base fiber and particle panel materials.
50. D1143-81 (1987)	Testing piles under static axial compressive load.
51. D1929-77 (1985)	Ignition properties of plastics.
52. D2843-77	Density of smoke from the burning or decomposition of plastics.
53. D4099-87	Specification for polyvinyl chloride (PVC) prime windows.
54. E72-80	Conducting strength tests of panels for building construction.
55. E84-87	Surface burning characteristics of building materials.
56. E108-87	Fire tests of roof coverings.
57. E119-88	Fire tests of building construction and materials.
58. E136-82	Behavior of materials in a vertical tube furnace at 750°C.
59. E283-84	Rate of air leakage through exterior windows, curtain walls and doors.
60. E447-84	Compressive strength of masonry prisms.
61. E648-88	Critical radiant flux of floor covering systems using a radiant heat energy source.
62. E814-94b	Standard Test Method for Fire Tests of Through-Penetration Fire stops.

Table 51.25-11

AWS	American Welding Society P.O. Box 351040 Miami, Florida 33135
Standard Reference Number	Title
1. D1.1-88	Structural Welding Code-Steel
2. D1.3-89	Structural Welding Code-Sheet Steel

Table 51.25-12

Standard Reference Number	Title
1. C1-1993	All Timber Products
2. C2-1988	Lumber, Timbers, Bridge Ties and Mine Ties—Preservative Treatment by Pressure Processes
3. C4-1989	Poles—Preservative Treatment by Pressure Processes
4. C9-1993	Plywood

Table 51.25-13

Standard Reference Number	Title
1. LP-2 1988	Standards for Softwood Lumber, Timber and Plywood Pressure Treated with Water-Borne Preservatives for Above Ground Use.
2. LP-22 1988	Standards for Softwood Lumber, Timber and Plywood Pressure Treated with Water-Borne Preservatives for Ground Contact Use.
3. FDN 1988	Quality Control Program For Softwood Lumber, Timber and Plywood Pressure Treated with Water-Borne Preservatives, for Ground Contact Use in Residential and Light Commercial Foundations.

Table 51.25-13M

Standard Reference Number	Title
1. 21 CFR, Section 1002.10 (1994)	None
2. 47 CFR, Part 5 (1993)	Experimental Radio Services

Table 51.25-14

Standard Reference Number	Title
4450, Revised Aug. 5, 1977	Approval Standard for Class I Insulated Steel Deck Roofs.

Table 51.25-15

Standard Reference Number	Title
GA-600-88	Fire Resistance Design Manual

Table 51.25-16

Standard Reference Number	Title
9023	Stainless Steel Cold-Formed Structural Design Manual, 1974 edition

Table 51.25-17

Standard Reference Number	Title
1. 10-1998	Standard for portable fire extinguishers.
2. 11-1998	Standard for Low-Expansion Foam.
3. 11A-1999	Standard for Medium- and High-Expansion Foam Systems.
4. 12-1998	Standard on Carbon Dioxide Extinguishing Systems.
5. 12A-1997	Standard on Halon 1301 Fire Extinguishing Systems.
6. 13-1999	Standard for the installation of sprinkler systems.
7. 13R-1999	Standard for the installation of sprinkler systems in residential occupancies up to and including four stories in height.
8. 14-1996	Standard for the Installation of Standpipe and Hose Systems.
9. 15-1996	Standard for water spray fixed systems for fire protection.
10. 16-1999	Standard for the Installation of Foam-Water Sprinkler and Foam-Water Spray Systems.
11. 17-1998	Standard for Dry Chemical Extinguishing Systems.
12. 17A-1998	Standard for Wet Chemical Extinguishing Systems.
13. 20-1999	Standard for the installation of centrifugal fire pumps.
14. 22-1998	Standard for water tanks for private fire protection.
15. 24-1995	Standard for the installation of private fire service mains and their appurtenances.
16. 25-1998	Standard for the inspection, testing, and maintenance of water-based fire protection systems.
17. 30-1996	Flammable and Combustible Liquids Code.
18. 30A-1996	Automotive and Marine Service Station Code.
19. 30B-1998	Manufacture and Storage of Aerosol Products.
20. 31-1997	Standard for the installation of oil-burning equipment.
21. 33-1995	Standard for Spray Application Using Flammable or Combustible Materials.

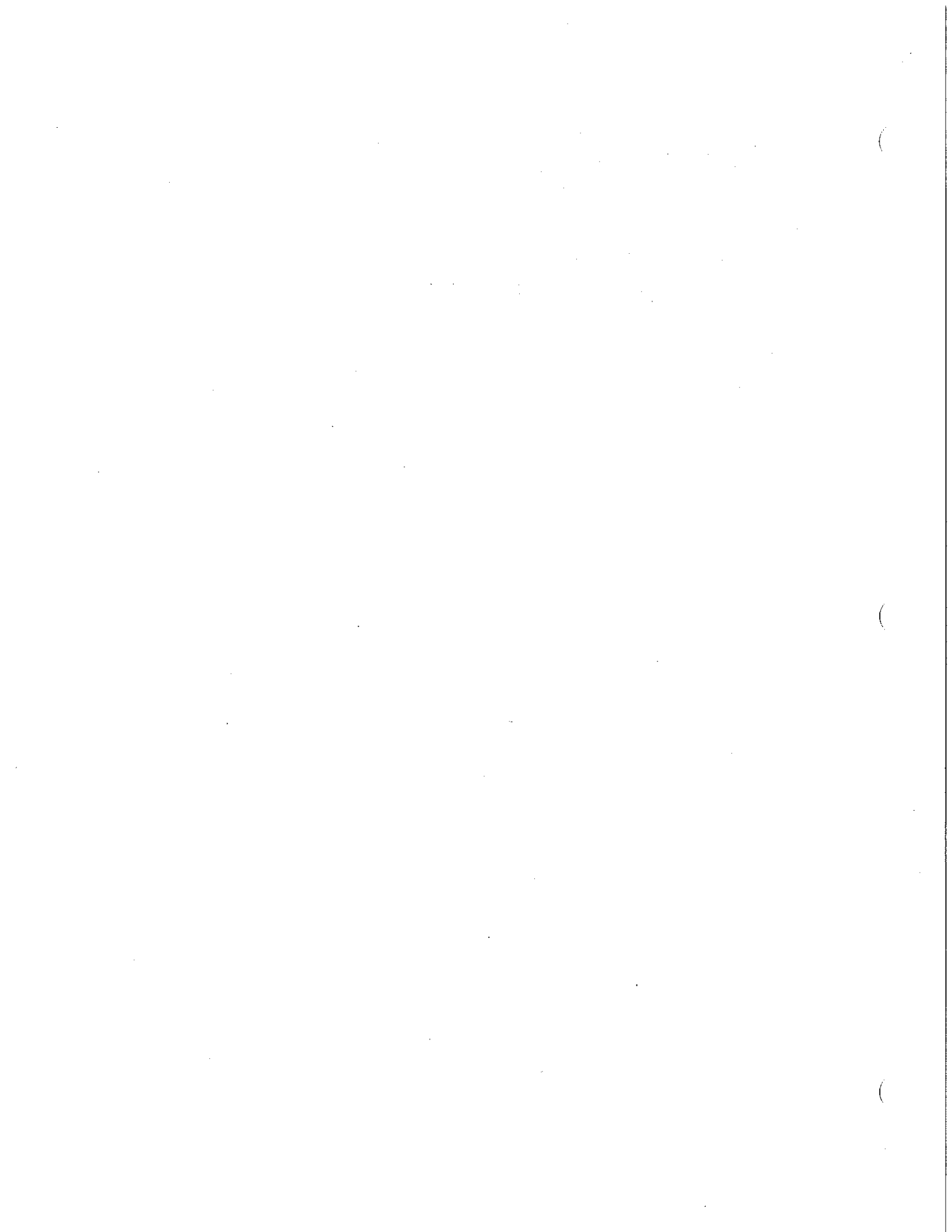
Table 51.25-17 - Continued

Standard Reference Number	Title
NFPA	National Fire Protection Association One Batterymarch Park P.O. Box 9101 Quincy, Massachusetts 02269-9101
22. 34-1995	Standard for Dipping and Coating Processes Using Flammable or Combustible Liquids.
23. 45-1996	Fire Protection for Laboratories Using Chemicals.
24. 51-1997	Standard for the Design and Installation of Oxygen-Fuel Gas Systems for Welding, Cutting, and Allied Processes.
25. 54-1999	National Fuel Gas Code.
26. 72-1999	National Fire Alarm Code.
27. 80-1999	Standard for Fire Doors and Fire Windows.
28. 90A-1999	Standard for the Installation of Air Conditioning and Ventilating Systems.
29. 96-1998	Standard for the Installation of Equipment for the Removal of Smoke and Grease-Laden Vapors from Commercial Cooking Equipment.
30. 211-1996	Standard for Chimneys, Fireplaces, Vents and Solid Fuel-Burning Appliances.
31. 230-1999	Standard for the Fire Protection of Storage.
32. 430-1995	Code for the Storage of Liquid and Solid Oxidizers.
33. 432-1997	Code for the Storage of Organic Peroxide Formulations.
34. 495-1996	Explosive Materials Code.
35. 701-1999	Standard Methods of Fire Tests for Flame Propagation of Textiles and Films.
36. 750-1996	Standard on Water Mist Fire Protection Systems.
37. 2001-1996	Standard on Clean Agent Fire Extinguishing Systems.
Table 51.25-17M	
NFRC	National Fenestration Rating Council 962 Wayne Ave., Suite 750 Silver Spring, Maryland 29010
Standard Reference Number	Title
1. 100-91	Procedure for Determining Fenestration Product Thermal Properties
2. LAP1-92, PCP1-92 and CAP1-92	Fenestration Thermal Performance Rating Certification and Labeling Program.

Table 51.25-18

Standard Reference Number	Title
NFoPA	National Forest Products Association 1250 Connecticut Avenue, N.W., #200 Washington, DC 20036
1. NDS	National Design Specification for Wood Construction, 1991 Edition, including Design Values for Wood Construction, a 1991 supplement to the 1991 Edition of National Design Specification for Wood Construction.
2. Technical Report No.7	The Permanent Wood Foundation System, Basic Requirements, Revised January, 1987.
Table 51.25-18M	
SMACNA	Sheet Metal and Air Conditioning Contractors National Association Vienna, Virginia 22180
Standard Reference Number	Title
	HVAC Duct Leakage Test Manual, 1st Edition, 1985.
Table 51.25-19	
SJI	Steel Joist Institute Suite A 1205 48th Ave., North Myrtle Beach, South Carolina 29577
Standard Reference Number	Title
	Standard Specifications, Load Tables and Weight Tables for Steel Joists and Joist Girders, 1988.
Table 51.25-20	
TPI	Truss Plate Institute, Inc. 583 D'Onofrio Dr., Suite 200 Madison, Wisconsin 53719
Standard Reference Number	Title
TPI-85	Design Specification for Metal Plate Connected Wood Trusses, including 1987 Supplement and Errata Addendum Sheet.
Table 51.25-21	
UL	Underwriters Laboratories, Inc. Publication Stock 333 Pfingsten Road Northbrook, Illinois 60062
Standard Reference Number	Title
1. 181-1981	Factory-Made Air Ducts and Connectors, including revisions dated March 19, 1994.
2. 1256-1985	Fire Test of Roof Deck Constructions.

History: Cr. Register, October, 1967, No. 142, eff. 11-1-67; cr. (88) to (93), Register, February, 1971, No. 182, eff. 7-1-71; r. (88) to (93) eff. 8-1-71 and recr. (88) to (93) eff. 1-1-72, Register, July, 1971, No. 187; r. and recr., Register, July, 1974, No. 223, eff. 1-1-75; am. (43), Register, December, 1978, No. 276, eff. 1-1-79; cr. (55), Register, May, 1980, No. 293, eff. 6-1-80; am. Register, December, 1981, No. 312, eff. 1-1-82; cr. (43a), (45a) and (45b), am. (47), Register, December, 1983, No. 336, eff. 1-1-84; am. Register, August, 1985, No. 356, eff. 1-1-86; r. and recr. Register, March, 1991, No. 423, eff. 4-1-91; am. tables 2, 15, 17, 18 and 20, Register, January, 1994, No. 457, eff. 2-1-94; am. Tables 10, 12 and 17, Register, March, 1995, No. 471, eff. 4-1-95; r. and recr. Table 51.25-7, Table 51.25-10, am. Table 51.25-9, Table 51.25-17, cr. Table 51.25-13M, Table 51.25-17M, Table 51.25-18M, Register, December, 1995, No. 480, eff. 4-1-96; r. and recr., Register, March, 1997, No. 495, eff. 4-1-97; am. Table 51.25-10, Register, September, 1998, No. 513, eff. 10-1-98; am. Table 51.25-17, Register, February, 1999, No. 518, eff. 3-1-99; am. Table 51.25-17, Register, March, 2000, No. 531, eff. 4-1-00; am. (1), r. and recr. (2), r. (3), renum. (4) to be (3), am. Table 51.25-17, Register, September, 2000, No. 537, eff. 10-1-00.



Chapter Comm 52

GENERAL REQUIREMENTS

Subchapter I — Fire Prevention, Detection and Suppression for High Rise Buildings

Comm 52.01 Fire prevention, detection and suppression for high rise buildings.

Subchapter II — Automatic Fire Sprinkler Systems for Low Rise Buildings

Comm 52.011 Purpose, scope and application.

Comm 52.012 Individual room, limited area and partial automatic fire sprinkler systems.

Comm 52.013 Specified applications by occupancy or use.

Subchapter III — Windows and Fire Department Access Openings

Comm 52.02 Windows.

Subchapter IV — Barrier-Free Design for the Physically Disabled

Comm 52.04 Requirements for barrier-free design.

Subchapter V — Courts

Comm 52.05 Size of courts.

Comm 52.06 Ventilation of courts.

Subchapter VI — Atriums

Comm 52.07 Atriums.

Subchapter VII — Miscellaneous Provisions

Comm 52.19 Gas and oil lamps.

Comm 52.20 Electrical work.

Comm 52.21 Location and maintenance of exits.

Comm 52.22 Repairs.

Comm 52.23 Cleanliness.

Comm 52.24 Recycling space.

Comm 52.25 Fire division wall or occupancy separation wall identification.

Subchapter VIII — Sanitary Facilities

Comm 52.50 Toilet rooms.

Comm 52.52 Sex designation.

Comm 52.53 Location, light and ventilation.

Comm 52.55 Artificial light.

Comm 52.56 Size.

Comm 52.57 Floor and base.

Comm 52.58 Walls and ceilings.

Comm 52.59 Enclosure of fixtures.

Comm 52.60 Sanitary facilities.

Comm 52.61 Protection from freezing.

Comm 52.62 Disposal of sewage.

Comm 52.63 Permanent and portable outdoor toilets.

Comm 52.64 Maintenance and housekeeping.

Note: Chapter Ind 52 was renumbered to be Chapter ILHR 52 effective 1-1-84. Corrections made under s. 13.93 (2m) (b) 7., Stats., Register, March, 1997, No. 495. Chapter ILHR 52 was renumbered chapter Comm 52 under s. 13.39 (2m) (b) 1., Stats. and corrections made under s. 13.93 (2m) (b) 7., Stats., Register, September, 1998, No. 513.

Subchapter I — Fire Prevention, Detection and Suppression for High Rise Buildings

Comm 52.01 Fire prevention, detection and suppression for high rise buildings. (1) AUTOMATIC FIRE SPRINKLER SYSTEM. A complete automatic sprinkler system, as specified in s. Comm 51.23, shall be provided in every building more than 60 feet in height the initial construction of which is commenced after July 2, 1974. The requirements of this section shall not apply to open parking structures as defined in s. Comm 62.10 (2).

(a) *Additions to existing buildings.* Building additions more than 60 feet in height shall have an automatic sprinkler system installed. The sprinkler protection shall be provided throughout the existing building unless the addition is separated from the existing building by a fire division wall as specified in s. Comm 51.02 (13). The requirements of this section shall not apply to open parking structures as defined in s. Comm 62.10 (2).

(b) *Substitute suppression systems.* When approved by the department, substitute automatic suppression systems may be used in lieu of a sprinkler system in areas where the use of water could cause unusual damage to equipment, or where water may have a limited effect or may be hazardous to use because of the nature of processes involved.

Note: The department will accept design and installation in accordance with the latest edition of the national fire protection association standards for special extinguishing systems.

(2) ADDITIONAL REQUIREMENTS FOR HIGH-RISE BUILDINGS. The following requirements apply to all buildings more than 100 feet in height or having more than 10 stories. Open parking structures and buildings used for low hazard industrial processes, including the production and distribution of gas, steam or electric power, foundries and similar uses which require unusual heights to accommodate cranes, special machinery or equipment, are exempt from the provisions of this subsection.

(a) *Smoke control.* Natural or mechanical ventilation for the removal of products of combustion shall be provided in every story and shall consist of one or more of the following methods.

Controlling devices may be automatic or manual as approved by the local fire department.

1. Panels or windows in the exterior wall which can be opened from a location other than the fire floor. Such venting facilities shall be provided at the rate of at least 20 square feet per 50 lineal feet of exterior wall in each story, and distributed around the perimeter at not more than 50-foot intervals. Such panels shall be clearly identified as required by the fire department.

2. Openable windows in habitable rooms of residential units.

3. When an automatic sprinkler system is installed in compliance with s. Comm 51.23, the mechanical air handling equipment may be designed to assist smoke removal. Under fire conditions, the return and exhaust air shall be taken directly to the outside without recirculation to other sections of the building.

4. A mechanical ventilation system which will prevent the transfer of smoke from the fire source to other floors of the building. The design shall be substantiated by calculations or tests showing that a pressure differential of 0.10 inch of water column will be produced.

5. Any other design which will produce equivalent results.

(b) *Exit stairways.* 1. All stairways shall be pressurized. The pressure across each door shall be at least 0.15 but not more than 0.20 inch of water column with all doors closed. Pressurization shall be activated by the fire alarm system, the detection systems, and the sprinkler system. In lieu of pressurization, a smokeproof stair tower, as defined in s. Comm 51.17, will be accepted.

Note: The department will accept alternate designs which will produce equivalent results.

2. All stairway doors which are to be locked from the stairway side shall have the capability of being unlocked without unlatching upon a signal from the central control station.

(c) *Elevators.* Every floor level of the building shall be accessible to a fire department by means of one or more elevators. If the building is not provided with an automatic sprinkler system in accordance with s. Comm 51.23, the elevator lobby at each floor level shall be separated from the remainder of the building by an effective smoke barrier.

Note: See ch. Comm 18 for additional requirements pertaining to elevators.

(d) *Fire alarm and detection system.* 1. A manual fire alarm box shall be located adjacent to exit doors into stairway shafts and in every elevator lobby.

2. An approved system which will provide for automatic detection of products of combustion other than heat shall be installed in every air-handling equipment room, unless sprinklered, and in the return air portion of every air conditioning and mechanical ventilation system. Approved heat detectors may be installed in boiler rooms and furnace rooms in lieu of product of combustion detectors.

a. Detectors shall be located in the main return air and supply air ducts of each ventilation system and at each opening into a vertical return air shaft or duct.

b. The detectors shall actuate an alarm or signaling system and shut down the ventilation system except where automatic smoke control is incorporated in the system.

3. The manual alarm and automatic detection system shall conform to the Wisconsin State Electrical Code, Volume 2, ch. Comm 16 and NFPA 72.

4. Detectors shall conform to NFPA 72.

(e) *Alarm and communication systems.* The following alarm and communication systems shall be provided. The systems shall be supervised and exposed wiring shall be encased in a metal conduit.

1. Voice alarm system. The detection system, sprinkler water flow device and the fire alarm system shall actuate a prerecorded message or voice alarm capable of being operated from the central control station on a general as well as a selective basis to the area involved. The alarm shall be designed to be heard by all occupants within the building or designated portions.

2. Voice communication system. There shall be a voice communication system between the central control station and the following areas:

Note: The department will accept systems installed in accordance with NFPA 72.

a. Elevators, elevator lobbies, in stairways at every fifth floor, and all manual fire alarm boxes (2-way communication system);

b. Every office area exceeding 1,000 square feet in area (one-way address system); and

c. Each dwelling unit and hotel guest room (one-way address system).

3. Fire department communication system. A system providing 2-way communication shall be provided at all floor levels, stairways, the central control station, and other locations required by the fire department.

a. The system shall be designed so the fire department communication system will override the other communication systems.

b. Wiring shall be arranged so that open circuits or short circuits on individual floors will not interfere with communications on another floor.

4. Combined system. When approved by the local fire department, the fire department communication system may be combined with the voice communication system and the voice alarm system.

(f) *Central control station.* A central control station for fire department operations shall be provided in a location approved by the fire department. It shall contain the voice communication systems panel; fire detection and alarm system panels; status indicators and controls for elevators, smoke venting and air handling systems; controls for unlocking stairway doors; a public telephone; sprinkler valve and water flow detectors; and standby power controls. All fire alarm and water flow signals shall be transmitted directly to the systems indicated in s. Comm 52.01 (2) (d) 3.

(g) *Standby power and light.* An approved permanently installed standby power generating system shall be provided. The system shall be equipped with suitable means for automatically starting the generator set upon failure of the normal electrical service and for automatic transfer and operation of the required electrical functions at full power within 60 seconds of such normal ser-

vice failure. System supervision with manual start and transfer features shall be provided at the central control station.

1. An on-premise fuel supply sufficient for not less than 2 hours full demand operation of the system shall be provided.

2. The power requirement shall be determined so as to provide service to, but not limited to the following:

a. Fire alarm system;

b. Exit and other emergency lighting;

c. Fire protection equipment;

Note: Standby power to service fire pumps may be omitted if approved by the local fire department.

d. Mechanical ventilation required by this section;

e. Fire department elevator; and

f. Communication systems.

(h) *Maintenance.* All communications, fire prevention, detection and suppression systems required under this section shall be tested and maintained in an operable condition. All installed automatic sprinkler systems shall be maintained pursuant to NFPA 25. Records of inspections, tests and maintenance, as specified in NFPA 25 shall be kept and shall be made available, upon request, to the department or its authorized deputies. The local fire department shall be notified whenever the life safety systems are shut down or impaired and when placed back in service. The owner shall arrange for immediate and continual servicing or repair of the communication, fire prevention, detection and suppression systems until they are placed back in operation.

(i) *Floor level identification.* Each floor level or story shall be identified as to its number or name. Identification signs shall be posted in all elevator lobbies and in all required exit stairways.

History: Emerg. cr. eff. 1-1-75; cr. (1), Register, April, 1975, No. 232, eff. 5-1-75; cr. (2), Register, April, 1975, No. 232, eff. 1-1-76; (2), eff. 1-1-77; am. (2), Register, December, 1976, No. 252, eff. 1-1-77; am. (2) (d) 2. a. and cr. (2) (i), Register, December, 1977, No. 264, eff. 1-1-78; am. (1) (intro.), (a), (2) (intro.) and (2) (e) 2. a., Register, December, 1978, No. 276, eff. 1-1-79; am. (2) (h), Register, December, 1981, No. 312, eff. 1-1-82; am. (2) (h), Register, June, 1983, No. 330, eff. 7-1-83; emerg. am. (2) (h), eff. 9-6-86; am. (2) (h), Register, November, 1986, No. 371, eff. 12-1-86; r. and recr. (2) (c), Register, March, 1991, No. 423, eff. 4-1-91; am. (2) (d) 3. a. and b., 4 and (h), r. (2) (d) 3. c. and d., Register, January, 1994, No. 457, eff. 2-1-94; am. (2) (d) 3. and 4., Register, February, 1999, No. 518, eff. 3-1-99; r. (1) (c), Register, March, 2000, No. 531, eff. 4-1-00.

Subchapter II — Automatic Fire Sprinkler Systems for Low Rise Buildings

Comm 52.011 Purpose, scope and application.

(1) GENERAL. Pursuant to s. 101.14 (4) (a), (c) and (g), Stats., created by 1983 Wis. Act 295, this subchapter establishes automatic fire sprinkler system requirements for buildings under 60 feet in height which are used as public buildings or places of employment.

(2) GENERAL REQUIREMENT. Except as provided in sub. (3), automatic fire sprinkler systems shall be installed in the rooms, areas, locations, and building occupancies as specified in ss. Comm 52.012 and 52.013.

Note: See s. Comm 51.23 for additional system installation requirements.

(3) ALTERNATE METHODS. When approved by the department through the petition for variance process, alternate methods of fire protection, detection or suppression providing an equivalent degree of life safety protection may be provided.

Note: See s. Comm 50.25 for the procedure used for submitting a petition for variance to an administrative rule.

(4) SYSTEM DEFINITION AND STANDARD. The automatic fire sprinkler systems specified in this subchapter shall conform to the definition specified in s. Comm 51.01 (7a) and shall comply with the requirements specified in the applicable standards listed in Table 51.25-17.

Note: The definition of the term "automatic fire sprinkler system" in s. Comm 51.01 (7a) is taken from s. 145.01 (2), Stats.

Note: See s. A52.011 of Appendix A for additional information pertaining to fire hazard classifications, building usage, and occupancy.

(5) AREA SEPARATION WALLS. (a) Buildings having an area exceeding the area limitations specified in s. Comm 52.013, may

be constructed without complete automatic fire sprinkler systems provided the building is divided into areas less than the specified area limitations by at least 2-hour rated vertical fire separation walls. The fire separation wall shall extend from the foundation to the underside of the roof deck.

1. Structural framing members may continue through or over the separation wall provided the framing and supporting elements are of noncombustible or one-hour fire-resistive combustible construction.

2. All openings in the separation wall shall be protected by fire-resistive door assemblies as specified in s. Comm 51.047.

(b) Where additions to buildings result in the area of the entire building exceeding the area limitations specified in s. Comm 52.013, one of the following conditions shall apply:

1. The existing building and the building addition shall be completely protected by an automatic fire sprinkler system;

2. The building addition shall be separated from the existing building by a 2-hour rated vertical fire separation wall. If the area of the building addition exceeds the area limitations specified in s. Comm 52.013, the building addition shall be completely protected by an automatic fire sprinkler system or the building addition shall be divided with 2-hour rated vertical fire separation walls as specified in par. (a); or

3. The existing building and the building addition shall be divided by 2-hour rated vertical fire separation walls as specified in par. (a).

(6) **MULTIPLE USE BUILDINGS.** Where a building contains multiple occupancies or use areas and one occupancy or use area is required by s. Comm 52.013 to be protected by an automatic fire sprinkler system, one of the following conditions shall apply:

(a) The occupancy or use area protected by the automatic fire sprinkler system shall be separated from the unprotected areas by at least 1-hour fire-resistive rated construction; or

(b) The entire building shall be protected by an automatic fire sprinkler system.

Note: See ss. Comm 55.05 and 59.22 for occupancy separation requirements mandating fire-resistive separations of more than 1-hour rating.

(7) **SEPARATION OF AREAS PROTECTED BY A PARTIAL AUTOMATIC FIRE SPRINKLER SYSTEM.** Where the provisions of s. Comm 52.012 require the protection of an automatic fire sprinkler system, the protected area or room shall be enclosed with construction assemblies as specified in chs. Comm 54 to 62 and as designated in Table 51.03-A for the class of construction.

Note: This rule is intended to require an effective fire barrier between those portions of the building protected by the automatic fire sprinkler system and the adjoining unprotected portions. The fire barrier is not required to be of fire-resistive construction unless required for the occupancy, use or class of construction.

History: Emerg. cr. eff. 9-6-86; cr. Register, November, 1986, No. 371, eff. 12-1-86; am. (4), Register, March, 2000, No. 531, eff. 4-1-00.

Comm 52.012 Individual room, limited area and partial automatic fire sprinkler systems. The rooms or areas within buildings as specified in subs. (1) to (4) shall be protected by an automatic fire sprinkler system.

(1) **WINDOWLESS FLOOR LEVELS.** (a) Except as permitted in pars. (b) and (c), automatic fire sprinkler system protection shall be provided in all basements and floor levels where openings as specified in s. Comm 52.02 (2) are not provided.

(b) Automatic fire sprinkler system protection need not be provided in the following windowless floor level applications:

1. Windowless floor levels of 2500 square feet or less in total area and equipped with an approved smoke detection system which is:

a. Directly and permanently wired to a proper unswitched circuit; and

b. Interconnected to the building manual fire alarm system. If the building does not have a manual fire alarm system, the smoke detection system shall be capable of sounding an audible alarm which can be heard in all occupied areas of the building.

2. Communication equipment rooms separated from the remainder of the building by at least one-hour fire resistive construction and the room is equipped with an approved automatic fire detection and alarm system;

3. Windowless floor levels in ch. Comm 54 occupancies classified as low hazard and not exceeding 3000 square feet in area;

4. Windowless floor levels within individual living units of ch. Comm 57 occupancies;

5. Interior balconies and open mezzanine floors; and

6. Windowless floor levels in hospitals and nursing homes.

Note: See chs. Comm 58 and HFS 124 and 132 for additional requirements.

(c) One-story buildings with no floor levels below the first floor need not be provided with exterior wall openings other than the required exits. Except as provided in par. (b), enclosed mezzanine floor levels shall be protected by an automatic fire sprinkler system or provided with exterior wall openings.

(2) **LAUNDRY AND TRASH COLLECTION ROOMS AND CHUTES.** Automatic fire sprinkler system protection shall be provided in all laundry and trash chutes and terminal rooms. Automatic fire sprinklers shall be installed at the top of the chute and at alternate floor levels.

(3) **STORAGE AREAS.** (a) Except as provided in par. (b), automatic fire sprinkler system protection shall be provided in storage areas exceeding 100 square feet in area and located in chs. Comm 55, 56, and 57 occupancies. The areas of individual adjacent storage areas shall be considered cumulatively unless each storage area is separated from the adjacent area by at least 30 minute fire resistive rated construction with openings protected by 20 minute rated fire doors.

(b) Automatic fire sprinkler system protection need not be provided in the following storage area applications:

1. Storage areas not exceeding 1500 square feet in area which are separated from the remainder of the building by at least one-hour fire resistive construction and the area is equipped with an approved smoke detection system, which is:

a. Directly and permanently wired to a proper unswitched circuit; and

b. Interconnected with the building manual fire alarm system. If the building does not have a manual fire alarm system, the smoke detection system shall be capable of sounding an audible alarm which can be heard in all occupied areas of the building; and

2. Storage areas located within individual living units of ch. Comm 57 occupancies.

(4) **STAGE AREAS REQUIRING PROSCENIUM SEPARATIONS.** Automatic fire sprinkler system protection shall be provided for all stage areas requiring proscenium separations within or behind the proscenium separation as follows:

(a) Over the stage;

(b) Under the stage gridiron with side wall sprinkler heads rated at 135° having heat baffle plates. The heads shall be installed around the entire perimeter of the stage, except above the proscenium opening, at points not more than 30 inches below the gridiron, nor more than 6 inches below the baffle plate;

(c) Under all fly galleries;

(d) Under the stage;

(e) In all basements, workrooms, dressing rooms, store rooms and property rooms; and

(f) In toilet, lounge and smoking rooms.

History: Emerg. cr. eff. 9-6-86; cr. Register, November, 1986, No. 371, eff. 12-1-86; am. (1) (a), Register, March, 1991, No. 423, eff. 4-1-91.

Comm 52.013 Specified applications by occupancy or use. Except as provided in s. Comm 52.011 (5), a complete automatic fire sprinkler system shall be installed as specified in the following occupancies:

(1) **MERCANTILE OCCUPANCIES.** (a) Except as provided in par. (b), in mercantile occupancies where the area exceeds 15,000 sq.

ft. per floor or 30,000 sq. ft. total area of all floors; or the height exceeds 3 stories;

(b) Mercantile occupancies without complete automatic fire sprinkler protection may be constructed up to the areas permitted in Table 54.01-1, but not exceeding 20,000 sq. ft. per floor provided the following conditions are satisfied:

1. The building is completely equipped with an automatic smoke detection system monitored by a fire alarm system company, proprietary or remote station service;

2. The distance to an exit does not exceed 100 feet; and

3. Street access for fire fighting vehicles is provided on at least 50% of the building perimeter.

(2) **EXHIBITION ROOMS.** In rooms having more than 12,000 sq. ft. of floor area which can be used for exhibition or display purposes.

(3) **LIBRARIES AND MUSEUMS.** In libraries and museums either of which exceed 15,000 sq. ft. area per floor.

(4) **RESTAURANTS, NIGHT CLUBS AND DANCE HALLS.** (a) In restaurants where the floor area exceeds 12,000 sq. ft. per floor or where the capacity is more than 1,000 persons.

(b) 1. In buildings with rooms primarily used for dance halls or entertaining occupants who are drinking or dining and unseparated accessory uses where the total area exceeds 5,000 sq. ft. per floor or where the capacity is more than 300 persons.

2. The area of accessory rooms such as but not limited to kitchens, storage rooms and other use areas shall be included unless the accessory rooms are separated from the remainder of the building by at least one-hour fire-resistive construction.

(5) **DETENTION AND CORRECTION FACILITIES.** In all detention and correctional facilities with a resident population of 6 or more.

(6) **STORAGE OCCUPANCIES.** (a) 1. Except as provided in par. (b), in buildings having an area exceeding 20,000 sq. ft. and used for high-piled storage of moderate hazard contents as specified in subd. 2.

2. High-piled storage shall include moderate hazard combustible materials in closely packed piles more than 15 feet in height or moderate hazard combustible materials on pallets or in racks more than 12 feet in height.

(b) The automatic fire sprinkler system protection may be limited to the storage area of the building only provided the storage area is separated from the remainder of the building by at least 2-hour fire-resistive rated construction.

(c) The automatic fire sprinkler system protection required under this subsection shall be in accordance with NFPA 13 and NFPA 230.

Note: See s. A52.011 for additional information on classification of hazards.

(7) **HIGH HAZARD BUILDINGS.** (a) Except as provided in par. (b), an automatic fire sprinkler system shall be installed in all high hazard occupancies exceeding 3000 sq. ft. in floor area.

Note: See s. A52.011 of Appendix A for additional information regarding classification of hazards.

(b) When approved by the department, alternate fire suppression systems appropriate for the particular hazard may be provided.

Note: The department will request a position statement regarding the proposed method to be submitted by the fire chief of the municipality having jurisdiction.

History: Emerg. cr. eff. 9-6-86; cr. Register, November, 1986, No. 371, eff. 12-1-86; am. (4) (a) and (b) 1., Register, March, 1991, No. 423, eff. 4-1-91; am. (6) (c), Register, January, 1994, No. 457, eff. 2-1-94; renum. (6) (b) 1. to be (6) (b), r. (6) (b) 2., r. and recr. (6) (c) and am. (7) (b), Register, March, 2000, No. 531, eff. 4-1-00.

Subchapter III — Windows and Fire Department Access Openings

Comm 52.02 Windows. (1) **NATURAL LIGHT.** (a) Every room in which one or more persons live or sleep, shall be lighted by a skylight or skylights, or a window or windows opening

directly upon a street or alley or upon a court on the same lot with the building, except as permitted [in] s. Comm 57.13 (2).

(b) Windows shall not be required in storage rooms, factories, offices, mercantile facilities, educational facilities or areas where the nature of occupancy will not permit windows provided artificial lighting as specified in ch. Comm 73 is provided.

(2) **FIRE DEPARTMENT ACCESS OPENINGS.** (a) *Application.* Any basement or any floor level which is not protected by an automatic fire sprinkler system shall be provided with at least 20 square feet of aggregate opening in each 50 lineal feet of exterior wall of that basement or floor level on at least one side of the building, except as permitted under s. Comm 52.012 (1). For the purpose of this requirement, openings 20 square feet in area spaced 100 feet apart and no more than 50 feet from the end of a wall shall satisfy the intent of this requirement.

(b) *Dimensions.* Openings shall have minimum dimensions of not less than 22 inches by 42 inches. The bottom of the opening shall be not more than 48 inches above the floor.

(c) *Accessibility.* The openings shall be accessible to the fire department from the exterior and shall be unobstructed to allow fire-fighting and rescue operations.

1. a. A clear space not less than 5 feet in width measured perpendicular to the building wall shall be provided outside of access openings.

b. A stairway or ramp to grade not less than 3 feet in width shall be provided where the bottom of the opening is more than 4 feet below grade.

2. An interior stairway may serve as basement access if the stairway leads directly to an exterior door and is separated at the first story with one-hour fire-resistive rated construction and protected openings. The stairway may not serve any floor level above the first story.

3. A skylight or hatch may serve as a basement access opening if a ladder or stairs from the floor below is provided.

4. Access openings shall be doors, windows, glazed panels or other panels readily identifiable and operable from the outside. Access panels requiring the use of a key, special tools or devices for opening will be permitted if approved by the fire department having jurisdiction.

5. The fire department access shall open into the general area of the floor being served, where an aisle or passageway leading to the opening can be maintained clear of obstructions.

Note: An opening located within a tenant storage cubicle is not acceptable.

(d) *Number of openings required.* Except as provided in s. Comm 52.012 (1) (c), every floor level of a building more than 75 feet deep, measuring at right angles to the openings, shall have openings in that level on at least 2 sides of the building.

(e) *Locations.* Openings in the basement shall be located so any location in the basement is within 75 feet of an opening.

History: 1-2-56; am. Register, December, 1962, No. 84, eff. 1-1-63; r. and recr. (1) (a), Register, October, 1967, No. 142, eff. 11-1-67; am. (1) (a) Register, May, 1971, No. 185, eff. 6-1-71; r. and recr., Register, September, 1973, No. 213, eff. 10-1-73; cr. (1) (b), Register, January, 1980, No. 289, eff. 2-1-80; r. and recr. Register, June, 1983, No. 330, eff. 7-1-83; r. and recr. (2), Register, February, 1984, No. 338, eff. 3-1-84; emerg. r. and recr. (2), eff. 9-6-86; r. and recr. (2), Register, November, 1986, No. 371, eff. 12-1-86; r. and recr. (1) (a) (intro.) and (2) (a), r. (1) (a) 1. and 2., (b) 2., renum. (1) (b) 1. to be (b), Register, March, 1991, No. 423, eff. 4-1-91; am. (2) (d), Register, January, 1994, No. 457, eff. 2-1-94; correction in (1) (b) made under s. 13.93 (2m) (b) 7., Stats., Register, March, 2000, No. 531; am. (1) (b), Register, September, 2000, No. 537, eff. 10-1-00.

Subchapter IV — Barrier-Free Design for the Physically Disabled

Comm 52.04 Requirements for barrier-free design. (1) **PUBLIC BUILDINGS AND PLACES OF EMPLOYMENT.** Except for covered multifamily housing as specified in sub. (2), all public buildings and places of employment shall be designed to be accessible and usable by people with disabilities in accordance with the requirements of ch. Comm 69.

(2) **MULTIFAMILY HOUSING.** All covered multifamily housing as defined in s. Comm 57.77 (6) shall be designed and constructed in accordance with the requirements of ss. Comm 57.70 to 57.871.

History: Cr. Register, December, 1974, No. 228, eff. 1-1-75; r. and recr. (3) (b), (4), (5) and (9) (a) and (b), am. (6), (7) (a), (7) (e), (8) (c) and (d), r. (9) (d) 3., Register, December, 1975, No. 240, eff. 1-1-76; am. table, (4) (c) 2. and (6) (e), Register, December, 1976, No. 252, eff. 1-1-77; cr. (2) (b) and (c), (3) (a) 3., am. (3) (b) (intro.), (4) (b) and (c) 1., (5), (7) (a), (c) and (e), (8) (b) and (9) (a) 1. and 2., r. and recr. (8) (b), Register, December, 1977, No. 264, eff. 1-1-78; am. (4) (c) 2., (5) (b), (6) (a) to (c), (7) (a) and (8) (c), Register, December, 1978, No. 276, eff. 1-1-79; am. (4) table, (5) (b), (9) (a) 1., (9) (c) 1. and 2., r. and recr. (3) and (8), cr. (9) (a) 3., Register, January, 1980, No. 289, eff. 2-1-80; cr. (8) (h), Register, December, 1981, No. 312, eff. 1-1-82; am. (8) (e), Register, October, 1982, No. 322, eff. 11-1-82; r. and recr. Table 52.04, (3), (6) (c), (7) and (9), am. (4) (b), (8) (c) and (8) (h) 1., cr. (10), Register, December, 1983, No. 336, eff. 1-1-84; am. (3) (a) (intro) and 2., (3) (c) 1. and (d) 1., (6) (a), (7) (a), Table 52.04-B and (8) (e), r. and recr. (3) (d) 3., Table 52.04-A, (7) (c), (8) (d) and (10) (d), renum. (8) (f) to (h) to be (8) (g) to (i), cr. (8) (f) and (11), r. (10) (e), Register, August, 1985, No. 356, eff. 1-1-86; reprinted to correct error in (11) (a) 3., Register, May, 1988, No. 389; r. and recr. (4) (b), Register, August, 1988, No. 392, eff. 9-1-88; emerg. am. Table 52.04, eff. 1-12-93; am. (4) (c) 2., Register, August, 1993, No. 452, eff. 3-1-94; corrections in (3) made under s. 13.93 (2m) (b) 1., Stats., Register, December, 1993, No. 456; r. and recr. (2) and (4) (b), cr. (4) (d) and (6) (g), Register, March, 1994, No. 459, eff. 4-1-94; am. Table 52.04, Register, April, 1994, No. 460, eff. 5-1-94; r. and recr., Register, November, 1994, No. 467, eff. 12-1-94.

Subchapter V—Courts

Comm 52.05 Size of courts. (1) In applying the following requirements, a building from 30 to 43 feet high shall be considered as having at least 3 stories, and each additional 13 feet shall be considered an additional story.

(2) Outer lot line courts shall be not less than 5 feet wide for a court 2 stories or less in height and 40 feet or less in length, measured from the lot line to the wall of the building. For each additional story in height, the width of such court shall be increased one foot; and for each additional 15 feet or fraction thereof in length, the width of such court shall be further increased one foot.

(3) Outer courts between wings or parts of the same building, or between different buildings on the same lot, shall be not less than 6 feet wide for a court 2 stories or less in height and 40 feet or less in length. For each additional story in height, the width of such court shall be increased one foot, and for each additional 10 feet or fraction thereof in length, the width of such court shall be further increased one foot.

(4) Where outer courts or outer lot line courts open at each end to a street or other open space not less than 15 feet wide, the above lengths may be doubled.

(5) Inner lot line courts one story high shall be not less than 5 feet wide and not less than 45 square feet in area. Inner lot line courts 2 stories high shall be not less than 6 feet wide and not less than 60 square feet in area. For every additional story, every such inner lot line court shall be increased by at least one lineal foot in length and one lineal foot in its width.

(6) Inner courts shall be not less than 10 feet in width nor less than 150 square feet in area for courts 2 stories or less in the height; and for every additional story every such inner court shall be increased by at least one lineal foot in its length and one lineal foot in its width.

(7) Courts shall not be covered by a roof or skylight but the entire required area shall be open and unobstructed from the bottom thereof to the sky. No fire escape or stairway shall be constructed in any court unless the court be enlarged proportionately.

(8) Walls of inner courts whose least horizontal dimension is less than one-fourth the height, shall be faced with material with a permanent white surface or shall be painted white at least every 2 years.

(9) No buildings shall be altered or enlarged to encroach upon space reserved under this code for light and air on the lots or parcels of ground on which such building is erected.

History: 1-2-56; am. (2) and (5), Register, September, 1973, No. 213, eff. 10-1-73.

Comm 52.06 Ventilation of courts. At the bottom of every shaft or inner court there shall be sufficient access to such shaft or court to enable it to be properly cleaned out. Every inner court which is required under s. Comm 52.02 and which is more than one story in height, shall have an intake for fresh air, leading from the street or other open space. The area of such intake in square feet shall equal at least .002 of the number of cubic feet contained in the court, but such area need not be more than 50 square feet. Every intake shall be of not less than 2-hour fire-resistant construction and unless the intake is used as a passageway for persons, there shall be no openings into the same other than the inlet and outlet.

History: 1-2-56; am. Register, December, 1981, No. 312, eff. 1-1-82.

Subchapter VI—Atriums

Comm 52.07 Atriums. (1) SCOPE. (a) All buildings, except those classified as high hazard, fully protected by an automatic fire sprinkler system may have atriums complying with the provisions of this section.

Note: See s. A 52.011 for further information regarding the classification and listing of high hazard buildings.

(b) All atriums, except as provided in ss. Comm 55.09, 58.06 (2), 60.34, 61.12 (4) and 62.27 shall comply with the provisions of this section.

(2) **MINIMUM OPENING AND AREA.** Atriums shall have a minimum opening and area as specified in Table 52.07-1.

TABLE 52.07-1
Atrium Opening and Area

Height in Floor Levels	Minimum Clear Opening ¹ (Ft.)	Minimum Area (Sq. Ft.)
3-4	20	400
5-7	30	900
8 or more	40	1,600

¹The specified dimensions are the diameters of inscribed circles whose centers fall on a common axis for the full height of the atrium.

(3) **SMOKE CONTROL SYSTEM.** (a) *General.* A mechanically operated air-handling system shall be installed that will exhaust smoke either entering or developed within the atrium.

(b) *Exhaust openings.* 1. Exhaust openings shall be located in the ceiling or in a smoke trap area immediately adjacent to the ceiling of the atrium.

2. The lowest level of the exhaust openings shall be located above the top of the highest portion of door openings into the atrium.

(c) *Supply openings.* Supply openings shall be sized to provide a minimum of 50% of the exhaust volume and shall be located with the bottom of the opening within 18 inches of the floor of the lowest level of the atrium.

(d) *Supply air.* 1. When the height of the atrium is 55 feet or less, supply air may be introduced by gravity, provided smoke control is accomplished.

2. When the height of the atrium is more than 55 feet, supply air shall be introduced mechanically from the floor of the atrium and be directed vertically toward the exhaust outlets.

3. In atriums over 55 feet in height or where tenant spaces above the second story are open to the atrium, supplemental supply air may be introduced at upper levels.

(e) *Systems activation and operation.* 1. The exhaust and supply system for the atrium shall operate automatically upon the actuation of either the automatic fire sprinkler system within the atrium or areas open to the atrium or by the actuation of 2 or more smoke detectors required by sub. (4), or both.

2. The exhaust and supply equipment shall also be manually operable by controls designed for fire department use.

3. The smoke-control system may be separate or integrated with other air-handling systems.

4. When the smoke-control mode is actuated, air-handling systems which would interfere with the smoke-control system shall be automatically shut down.

(f) *Smoke-control in spaces.* Spaces separated from the atrium but sharing a common wall shall be provided with a smoke-control system as follows:

1. The mechanical air-handling equipment for the tenant space may be designed to accomplish smoke removal;

2. Upon activation of the smoke detection or automatic fire sprinkler system within the space, the return and exhaust air shall be moved directly to the outside without recirculation to other sections of the building; and

3. The air handling system shall provide a minimum of 6 air changes per hour of exhaust air for the tenant space involved.

(g) *Sizing of smoke-control systems.* The atrium smoke-control system shall exhaust not less than the following quantities of air:

1. Atriums of 600,000 cubic feet or less. a. Except as provided in subd. 1. b., a minimum of 6 air changes per hour but not less than 40,000 CFM for atriums having a volume of 600,000 cubic feet or less including the volume of any levels not physically separated from the atrium.

b. A lesser rate of air movement shall be acceptable provided it can be shown by test that smoke will not migrate beyond the perimeter of the atrium.

2. Atriums greater than 600,000 cubic feet. A minimum of 4 air changes per hour for atriums having a volume greater than 600,000 cubic feet including the volume of any levels not physically separated from the atrium.

(4) **SMOKE DETECTION SYSTEM.** (a) 1. An interconnected smoke detection system which will automatically operate the atrium smoke-control system shall be installed at the perimeter and on the ceiling of the atrium and on the ceiling of each floor level that is open to the atrium.

2. Smoke detectors shall be located within 15 feet of the atrium on floor levels open to the atrium.

(b) Smoke detection systems and individual smoke detectors shall be located and installed in accordance with their listing from a nationally recognized testing laboratory and s. Comm 51.245.

(5) **ENCLOSURE OF ATRIUMS.** (a) Except as provided in par. (b), atriums shall be separated from adjacent spaces by at least one-hour fire-resistive rated construction.

(b) Open exit balconies are permitted within the atrium.

(c) The separation between the adjacent space and the atrium as specified in par. (a) may be omitted on a maximum of any 3 floor levels, provided the remaining floor levels are separated as specified in par. (a).

(6) **OPENINGS IN THE ATRIUM ENCLOSURE.** (a) *Door openings.* 1. Except as provided in subd. 2., openings in the atrium enclosure shall be protected by at least $\frac{3}{4}$ -hour, self-closing fire door assemblies as specified in s. Comm 51.047.

2. The doors may be left open if equipped with an automatic closing device activated by products of combustion other than heat.

(b) *Fixed glazed openings.* Except as provided in subds. 1. and 2., fixed glazed openings shall be protected by at least $\frac{3}{4}$ -hour fire window assemblies as specified in s. Comm 51.048 and the total area of the openings shall not exceed 25% of the area of the common wall between the atrium and the room into which opening is provided.

1. In ch. Comm 57 residential occupancies, openings may be unprotected when the floor area of each guest room or living unit does not exceed 1000 square feet and each guest room or living unit has an approved exit not entering the atrium.

2. In all occupancies other than ch. Comm 57 residential occupancies, the tenant space may be separated from the atrium by a wired, tempered or laminated glass wall, in a gasketed frame so installed that the glazing system may deflect without breaking the glass before the automatic fire sprinkler system operates.

(7) **EXITING.** (a) *Exit distance.* When a required exit enters the atrium space, the travel distance from the doorway of the tenant space to an enclosed stairway, horizontal exit, exterior door or exit corridor shall not exceed 100 feet. The maximum allowable exit distance, as required by chs. Comm 54 to 62 shall also be met.

(b) *Prohibitions.* Sleeping rooms of ch. Comm 58 health care facilities shall not be permitted to have required exits through the atrium.

(c) Except as provided in ss. Comm 54.08, 55.09 and 57.08, unenclosed stairs within the atrium may not serve as required exit stairs.

(8) **OCCUPANCY SEPARATIONS.** (a) Except as provided in par. (b), at least a one-hour fire-resistive separation, as specified in s. Comm 51.08, shall be provided between different occupancies and each and every tenant space.

(b) The vertical portion of the occupancy separation adjacent to the atrium may be omitted between:

1. Chapter Comm 54 office and sales areas and ch. Comm 57 guest rooms and living units located on another level;

2. Chapter Comm 55 assembly halls without a stage and having an occupant load of less than 300 persons and ch. Comm 57 guest rooms and living units located on another level; and

3. Chapter Comm 54 office and ch. Comm 55 assembly halls without a stage and having an occupant load of less than 300 persons.

(9) **STANDBY POWER.** The smoke-control system for the atrium and the smoke-control system for the tenant space shall be provided with emergency standby power as specified in s. Comm 16.46.

(10) **INTERIOR FINISHES.** The interior finish of walls and ceilings of the atrium and all unseparated spaces as permitted in sub. (5) (c) shall be Class A. No reduction in class may be permitted for automatic fire sprinkler system protection.

(11) **ACCEPTANCE OF THE SMOKE-CONTROL SYSTEM.** Before occupancy, the smoke-control systems shall be tested in an approved manner and shall show compliance with the requirements of this section.

Note: See Appendix A for a reprint of an approved test procedure.

(12) **INSPECTION OF THE SMOKE-CONTROL SYSTEM.** (a) All operating parts of the smoke-control systems shall be tested by an approved inspection agency or by the owner or designated agent or the smoke control system shall be fully supervised.

(b) The tests shall be made every 3 months and a log of the tests shall be kept. Fully supervised smoke control systems shall be tested at least annually.

(c) The log shall be on the premises and available for examination by department personnel or authorized deputies of the department.

History: Cr. Register, August, 1985, No. 356, eff. 1-1-86; r. and recr. (1), Register, March, 1991, No. 423, eff. 4-1-91; r. and recr. (5), am. (8) (a) and (10), Register, January, 1994, No. 457, eff. 2-1-94; correction in (9) made under s. 13.93 (2m) (b) 7., Stats., Register, March, 2000, No. 531.

Subchapter VII — Miscellaneous Provisions

Comm 52.19 Gas and oil lamps. (1) Gas and oil lamps shall not be used where electricity is available, except within living units of apartment buildings.

(2) Gas and oil lamps shall be placed at least 6 feet above the floor level, at least 6 inches from any combustible partition or wall, and at least 2 feet (measured from top of flame) below any combustible ceiling unless properly protected by a metal shield with at least 2 inches of air space above. Swinging brackets shall be provided with a guard or stop so that the light cannot come

nearer to the partition or wall than one foot. In aisles and public passageways, every such light shall be protected by an incombustible guard unless the light is at least 7 feet above the floor. Gas and oil lights shall be kept at least 2 feet from any drape or window curtain.

(3) Every gas supply main shall have a service cock outside of the building, so placed and maintained that it can be shut off at any time without entering the building.

History: 1-2-56; am. (1), Register, September, 1973, No. 213, eff. 10-1-73.

Comm 52.20 Electrical work. All electrical work shall conform to the requirements of the Wisconsin State Electrical Code, Volume 2, ch. Comm 16, of the department.

Note: For the design requirements for transformer vaults, see ch. E 450 of the Wisconsin State Electrical Code, Volume 2, ch. Comm 16.

History: 1-2-56; am. Register, January, 1961, No. 61, eff. 2-1-61.

Comm 52.21 Location and maintenance of exits. Every exit mentioned in ss. Comm 51.15 to 51.20, inclusive, shall lead to a street, alley or open court connected with a street. All such exits and all passageways leading to and from the same, shall be kept in good repair and unobstructed at all times.

History: 1-2-56; am., Register, January, 1980, No. 289, eff. 2-1-80.

Comm 52.22 Repairs. Every building shall be kept in good repair and the roof shall be maintained to prevent leakage. All rainwater shall be so drained and conveyed to prevent dampness in the walls and ceilings.

Note: Public schools are required by s. 120.12 (5), Stats., to have annual building maintenance schedules, and are required by s. 121.02 (1) (i), Stats., to be safe and healthful.

History: Cr. Register, December, 1981, No. 312, eff. 1-1-82.

Comm 52.23 Cleanliness. Every building, including connecting yards, courts, passages, areas or alleys, shall be kept clean, and shall also be kept free from any accumulation of dirt, filth, rubbish, garbage, or other matter.

History: Cr. Register, December, 1981; No. 312, eff. 1-1-82.

Comm 52.24 Recycling space. (1) APPLICABILITY. All buildings under the scopes of chs. Comm 54 to 62 shall provide a separate room or designated space within or adjacent to the building for the separation, temporary storage and collection of recyclable materials likely to be generated by the building occupants, under any of the following conditions:

- (a) The construction of a new public building;
- (b) An increase in the existing area of a public building which increases the gross floor area of the structure by 50% or more; or
- (c) An alteration of 50% or more of the existing area of a public building that is 10,000 square feet or more in area.

Note: The collection and temporary storage of recyclable materials that are flammable or combustible is regulated by ch. Comm 14. Storage of liquids that are flammable or combustible is regulated by ch. Comm 10. Owners of buildings where these materials are stored should consult those chapters for isolation, removal and storage standards.

(2) DESIGNATED SPACE. Designated space for the separation, temporary storage and collection of recyclable materials shall be provided within or adjacent to all buildings under sub. (1), except where a separate trash collection room is provided. In buildings where a trash collection room is provided, a clearly designated space for recyclables shall be provided.

Note: See Appendix C for guidelines for recommended designated space.

(3) ROOMS FOR SEPARATION, COLLECTION AND STORAGE. (a) Separate rooms provided for the separation, collection and temporary storage of recyclable materials shall comply with s. Comm 52.012 (2).

(b) When an automatic fire sprinkler system is provided, the system shall be designed and installed in an acceptable manner, and material may not be placed closer than 18 inches below sprinkler deflectors or discharge orifices.

(c) For buildings regulated under ch. Comm 58, rooms provided for the separation, collection and temporary storage of recyclable materials shall comply with s. Comm 58.24 or 51.02 (2).

Note: Structural support for safe floor loads shall be in accordance with s. Comm 53.11 (1) (d).

(4) STORAGE HEIGHT. The height of recyclable materials temporarily stored shall be limited so that stacked material is stable and secured against sliding or collapse.

Note: See ch. Comm 14 for more restrictive storage heights, where applicable.

(5) CLEARANCE. (a) Containers for the collection or temporary storage or the space designated as a collection or storage point may not be located so as to limit the use of exits, exit passageways, stairways, fire escapes or areas normally used for safe egress for the building occupants or in such a manner as to obstruct normal movement of employees in the performance of their duties.

(b) Where mechanical equipment is used in the collection, separation, temporary storage or removal of recyclable materials, sufficient safe clearance shall be provided for equipment turning and passage.

(6) PROHIBITIONS. Storage of recyclable materials is prohibited within furnace or mechanical rooms. If designated space is adjacent to a building, the area provided may not be within 5 feet of combustible walls, wall openings or roof eaves.

Note: See ch. Comm 14 for more restrictive distances from storage of flammable and combustible materials to adjacent buildings and lot lines.

History: Cr. Register, October, 1992, No. 442, eff. 5-1-93; am. (3) (b), Register, January, 1994, No. 457, eff. 2-1-94; correction in (3) (c) made under s. 13.93 (2m) (b) 7., Stats., Register, March, 2000, No. 531.

Comm 52.25 Fire division wall or occupancy separation wall identification. (1) Purpose. Pursuant to s. 101.135, Stats., the purpose of this section is to establish uniform standards for the identification of fire division walls or occupancy separation walls of 2-hour fire-resistive rating or greater on the exterior of buildings.

(2) MUNICIPAL ORDINANCE. A city, village, or town may by ordinance require owners to identify the location of a fire division wall or occupancy separation wall at the exterior walls of buildings with a sign. A sign may not be required to identify a fire division wall or occupancy separation wall:

- (a) Abutting exterior walls of 2 or more buildings along streets in downtown areas;
- (b) With a visible parapet from the street;
- (c) Which extends above roofs and is an exterior wall of another part of a building; and
- (d) In buildings more than 3 stories.

(3) DEFINITION. "Fire division wall or occupancy separation wall" means a wall extending from the lowest floor level to or through the roof and extending the full width or length of the building.

Note: See "fire division wall" as defined in s. Comm 51.01 (144)(b); fire division wall requirements in accordance with s. Comm 51.02 (13), or occupancy separation wall requirements in accordance with s. Comm 51.02 (20); and occupancy separation requirements in accordance with Table 51.08.

(4) SIGN REQUIREMENTS. (a) *General.* The sign shall consist of 3 circles arranged vertically on the exterior wall marking the location of the fire division wall or occupancy separation wall and centered on the fire division wall or occupancy separation wall. The circles may be affixed directly to the surface of the building or may be placed on a background material which is affixed to the building.

(b) *Size of circle.* Each circle shall be the same size. The diameter of the circle shall be at least 1 1/2 inches, but no greater than 2 inches.

(c) *Spacing.* The circles shall be spaced equal distance apart. The maximum distance measured from the top of the uppermost circle to the bottom of the lowermost circle shall be 12 inches.

(d) *Color.* The color of the circle shall be limited to either red, amber (orange-yellow) or white (clear) and shall be reflective.

The color of the circle shall contrast with the color of the background.

(5) **LOCATION.** The top of the sign shall be located on the face of the exterior wall of the building and located no more than 12 inches below the eave, roof edge, fascia or parapet.

History: Cr. Register, January, 1994, No. 457, eff. 2-1-94.

Subchapter VIII — Sanitary Facilities

Comm 52.50 Toilet rooms. (1) Every place of employment and public building shall be provided with toilet rooms as specified in chs. Comm 54 to 62.

(2) Entrances for toilet rooms shall be provided with doors or mazed passageways to ensure privacy to the users of the toilet rooms, except as permitted in ss. Comm 56.16 (1) and 60.15 (3). If mazed passageways are employed in lieu of doors:

(a) The passageways of the maze shall be at least 48 inches in width;

Note: See appendix for further explanatory materials.

(b) The walls creating the maze shall be at least 6 feet 8 inches high;

(c) The maze shall prevent a direct view of the water closet compartments or urinals from the outside entrance of the maze;

(d) The maze shall prevent an indirect view of the water closet compartments or urinals from the outside entrance of the maze by means of mirrors located within the toilet room; and

(e) The toilet room shall be provided with an exhaust fan which is to be on continuously while the building is occupied, and which is to create a negative pressure within the toilet room with respect to the area outside the toilet room.

History: 1-2-56; am. Register, December, 1962, No. 84, eff. 1-1-63; am. Register, December, 1976, No. 252, eff. 1-1-77; r. and recr. Register, March, 1991, No. 423, eff. 4-1-91; am. (2) (intro.), (c) and (d), Register, August, 1993, No. 452, eff. 3-1-94.

Comm 52.52 Sex designation. Where separate toilet rooms are provided for each sex as required by this code, each toilet room shall be clearly marked with regard to the sex for which it is designated. Words such as MEN or WOMEN, in letters not less than one-inch high, or appropriate symbols may be used to designate the sex for which the toilet room is designed. Where a single toilet room is provided for use by either sex, the toilet room may be marked as UNISEX.

Note: The American Disabilities Act Accessibility Guidelines may require more restrictive standards on size and arrangement of toilet rooms as published in the Federal Register, 28 CFR, Part 36.

History: 1-2-56; am. Register, September, 1973, No. 213, eff. 10-1-73; am. Register, December, 1976, No. 252, eff. 1-1-77; am. Register, August, 1993, No. 452, eff. 3-1-94.

Comm 52.53 Location, light and ventilation. (1) Toilet rooms shall be ventilated in accordance with the provisions of s. Comm 64.65.

(2) Toilet rooms may not have ventilation openings in an elevator shaft or inner court that has windows of habitable rooms above unless the shaft or court has an area greater than 1,250 square feet and a least dimension greater than 20 feet.

History: 1-2-56; am. Register, December, 1962, No. 84, eff. 1-1-63; r. and recr. Register, October, 1967, No. 142, eff. 11-1-67; am. (3), Register, September, 1973, No. 213, eff. 10-1-73; am. (4) (intro.), Register, December, 1975, No. 240, eff. 1-1-76; am. (4), Register, December, 1981, No. 312, eff. 1-1-82; am. (2) (intro.), Register, August, 1993, No. 452, eff. 3-1-94; r. and recr. Register, December, 1995, No. 480, eff. 4-1-96; r. and recr. Register, March, 1997, No. 495, eff. 4-1-97.

Comm 52.55 Artificial light. Every toilet room, except those within living units, shall be artificially lighted during the entire period that the building is occupied, wherever and whenever adequate natural light is not available, so that all parts of the room, especially the toilet compartments, shall be provided with artificial light intensity of not less than 2.5 footcandles at the floor level.

History: 1-2-56; am. Register, September, 1973, No. 213, eff. 10-1-73.

Comm 52.56 Size. Every toilet room shall have at least 14 square feet of floor area with a minimum width of 3 feet, and at least 100 cubic feet of air space for each water-closet and each urinal in addition to the space required for lavatories if installed within the toilet room.

Comm 52.57 Floor and base. Every toilet room, except those within living units of apartment buildings, shall have the entire floor and the side walls to a height of not less than 4 inches of a material impervious to water.

Note: This section is also intended to prohibit the use of wall registers within 4 inches of the floor, baseboard registers and floor registers.

History: 1-2-56; am. Register, September, 1973, No. 213, eff. 10-1-73; am. Register, December, 1981, No. 312, eff. 1-1-82; am. Register, February, 1991, No. 422, eff. 3-1-91.

Comm 52.58 Walls and ceilings. (1) The walls and ceilings of every toilet room shall be completely covered with smooth non-absorbent material.

(2) The interior surface of walls and partitions shall be of light color to improve illumination and facilitate cleaning.

History: 1-2-56; r. and recr. Register, September, 1959, No. 45, eff. 10-1-59; am. (1), Register, December, 1977, No. 264, eff. 1-1-78.

Comm 52.59 Enclosure of fixtures. (1) PRIVACY. Water closets and urinals within a toilet room shall be arranged to ensure privacy. Water closets shall be enclosed with partitions, except as provided in ss. Comm 58.68 (1) (a) and 60.15 (3). Urinals shall be placed against walls at least 6 feet 8 inches high and arranged individually with or without partitions.

(a) Exceptions. 1. The above requirements need not apply to toilet rooms accommodating only a single water closet or urinal or as specified in s. Comm 58.69 (6) (b).

2. A privacy lock shall be provided for a toilet room with a single water closet and a nonregulated urinal when privacy partitions are not provided.

(2) **PARTITION DESIGN.** The partition enclosure shall provide privacy from an elevation of 12 inches above the floor to 5¹/₂ feet above the floor. All partitions and doors shall be of material and finish required for walls and ceilings under s. Comm 52.58 and ensure privacy.

(3) **COMPARTMENT DESIGN.** The water closet compartments in toilet rooms shall be not less than 30 inches in width, and shall be not less than 54 inches in depth with a clearance of not less than 24 inches between the fixture and the compartment door when closed except as specified in ch. Comm 69. Compartment doors which are hung to swing inward shall clear the fixture by not less than 2 inches.

(4) **PROHIBITIONS.** No admission fee shall be charged for the use of any toilet room in a public building or place of employment. Key-locking of toilet rooms is prohibited in all buildings except service stations and filling stations having exterior toilet room access.

Note: Section 146.085, Stats., prohibits charging a fee for the use of any toilet compartment and imposes a fine for violations.

History: 1-2-56; am. (3) and cr. (4), Register, November, 1963, No. 95, eff. 12-1-63; am. (2), Register, February, 1974, No. 218, eff. 3-1-74; r. (4), Register, December, 1974, No. 228, eff. 1-1-75; am. (3), Register, December, 1975, No. 240, eff. 1-1-76; cr. (4), Register, December, 1976, No. 252, eff. 1-1-77; am. (1), Register, December, 1977, No. 264, eff. 1-1-78; am. (1) (intro.), Register, March, 1991, No. 423, eff. 4-1-91; am. Register, August, 1993, No. 452, eff. 3-1-94.

Comm 52.60 Sanitary facilities. (1) WATER CLOSETS. (a) Except as provided in pars. (b) and (c), all water closets required to be provided in public buildings and places of employment shall:

1. Be of an elongated bowl type; and

2. Provided with either:

a. Hinged, open-front seats without covers; or

b. Hinged, closed-front seats, without covers, which are encased with a continuous plastic sleeve capable of providing a

clean surface for every user and for which a specific material approval under s. Comm 50.19 has been issued.

(b) Water closets which are required to be provided in day care centers or individual living units or sleeping units of residential occupancies within the scope of either ch. Comm 57 or 61 may be of a round-bowl type with a hinged, closed front seat with or without a cover.

Note: Under s. Comm 84.20 (3) all water closets may not use more than 4 gallons of water per flush.

Note: The plumbing code, s. Comm 84.20 (5) (m) 7., prescribes requirements for water closets relative to their location to partitions, side walls and other obstructions. See appendix for further explanatory material.

(c) A composting toilet system complying with s. Comm 91.10 or an incinerating toilet complying with s. Comm 91.11 may be substituted for any water closet.

(2) **URINALS.** (a) *Stall type.* Stall-type urinals shall be set into the floor, and the floor shall be graded toward the fixture. Spaces between stall-type urinals, or urinals and sidewalls, shall be filled in flush with the front and top of the urinal with nonabsorbent material if the space is less than 12 inches.

(b) *Wall type.* Wall-hung urinals may be installed in all buildings except child day care facilities and elementary schools from kindergarten through 8th grade.

Note: The definitions and general classifications for schools are found in s. 115.01, Stats.

Note: The department recommends that wall-hung urinals be installed at a height between 22 inches to 24 inches above the floor.

Note: See s. Comm 52.04 (8) for additional requirements dealing with making wall-hung urinals accessible for people with disabilities.

(c) *Flushing devices.* The urinals shall be equipped with an effective flushing device which limits the use of water to not more than 1.5 gallons per urinal per flush.

(d) *Multiple urinals.* Batteries of urinals shall be spaced not less than 30 inches center-to-center. The center line of a single urinal shall be at least 16 inches from the nearest sidewall or partition.

(e) *Materials.* Only individual urinals of porcelain, vitreous china, stainless steel, or other nonabsorbent materials approved by the department shall be used.

(3) **HAND-WASHING AND DRYING FACILITIES.** Hand-washing facilities shall be provided in all places of employment and public buildings as specified in the occupancy chapters of chs. Comm 54 to 62.

(a) *Lavatories.* Except as provided in sub. (6), lavatories shall be of an approved type and shall be provided with hot and cold running water. Lavatories in toilet rooms of private living units shall be equipped to limit the flow of water to not more than 3 gallons per minute. The lavatories may be equipped with a hot and cold regulating device. If a multiple-use lavatory is installed, 24 lineal inches of wash sink or 20 inches measured along the edge of a circular basin will be considered equivalent to one lavatory. At least one lavatory shall be provided either in each toilet room or in a sex-designated lounge adjacent to the toilet room.

(b) *Hand-drying facilities.* Individual hand towels, sections of cloth or paper, or clean individual sections of continuous towel, convenient to the lavatories, shall be provided. Hand-drying facilities shall be provided at the ratio of at least one unit for every 3 lavatories. Warm-air blowers may be substituted for up to one-half of the required hand-drying units. Warm-air blowers shall provide air at not less than 90° F, nor more than 140° F.

Note: The department will accept the qualified blowers listed by Underwriters' Laboratories, Inc.

(c) *Toilet soap.* Soap or similar cleansing agents shall be provided.

(d) *Receptacles.* Receptacles shall be provided for the disposal of used towels and other waste materials.

(4) **DRINKING FACILITIES.** Drinking facilities shall be provided in all buildings except in areas where food and drinks are served. Drinking facilities shall not be installed in toilet rooms, except in residential occupancies. Drinking fountains, coolers or individual

cups at a potable water source may be provided. Common drinking cups are prohibited.

Note: Where running water is not available, a covered drinking water container, equipped with a faucet or bubbler, may be provided. The container should be cleaned and sanitized at frequent intervals.

(5) **BATHING FACILITIES.** Bathing facilities shall be provided for the specific occupancies outlined in the occupancy chapters of this code.

(a) All shower compartments, regardless of shape, shall have at a minimum finished interior of 900 square inches and shall be capable of encompassing a 30-inch circle. The minimum required area and dimension shall be measured at a height 24 inches above the top of the threshold and at a point tangent to its centerline. The minimum area and dimensions shall be maintained to a point 70 inches above the shower waste outlet with no protrusions other than the fixture valve or valves, showerheads, soap dishes and safety grab bars or rails. Each shower room or compartment shall be constructed of material impervious to moisture. The floor of the shower room or compartment shall be provided with a slip-resistant finish.

(b) Except as provided in sub. (6), bathing facilities shall be provided with hot and cold water and be equipped with a hot and cold water regulating device. The device shall be plainly marked. Supply or feed pipes to showers shall be placed overhead or protected to avoid the probability of a person coming in contact with the hot water pipes. Showers shall be equipped to limit the flow of water to not more than 3 gallons per minute per shower head.

(c) Employees who use showers shall be provided with soap or other appropriate cleansing agents and clean individual towels.

Note: See ch. Comm 82 for special fixture requirements.

(6) **LAVATORIES, USE OF HOT OR TEMPERED WATER.** (a) Lavatories, wash fountains and shower heads which are not located in dwelling units or living units shall be supplied with either tempered water or hot water.

1. Tempered water shall be provided to lavatories, wash fountains and shower heads by means of tempering mixing valves.

(b) Lavatories located in park shelters and bath houses which are not open during the period from November 15 to March 15 and which are not places of employment shall not be required to be provided with hot water.

(c) Lavatories located in waysides which are not places of employment shall not be required to be provided with hot water.

Note: The exception of providing hot water under pars. (a) to (c) does not supercede the requirements of other state agencies for providing hot water.

History: 1-2-56; r. and recr., Register, September, 1959, No. 45, eff. 10-1-59; am. (1), Register, September, 1973, No. 213, eff. 10-1-73; r. and recr., Register, December, 1974, No. 228, eff. 1-1-75; am. (1) and (2) (d), r. and recr. (2) (b), cr. (2) (f), (3), (4) and (5), Register, December, 1976, No. 252, eff. 1-1-77; am. (2) (c), Register, May, 1978, No. 269, eff. 6-1-78; am. (1), (2) (c), (3) (a) and (5) (b), Register, January, 1980, No. 289, eff. 2-1-80; r. (2) (f), r. and recr. (5) (a), Register, August, 1985, No. 356, eff. 1-1-86; am. (3) (a) and (5) (b), cr. (6), Register, May, 1988, No. 389, eff. 6-1-88; r. and recr. (1) and (3) (intro.), Register, March, 1991, No. 423, eff. 4-1-91; am. (2) (b) and (3) (a), Register, January, 1994, No. 457, eff. 2-1-94; r. (6) (a) 2. and 3., Register, October, 1994, No. 466, eff. 11-1-94; am. (1) (a) (intro.) and cr. (1) (c), Register, April, 2000, No. 532, eff. 7-1-00; am. (3) (a), Register, September, 2000, No. 537, eff. 10-1-00.

Comm 52.61 Protection from freezing. All portions of plumbing water supply systems shall be protected against freezing in accordance with s. Comm 82.40 (8) (a).

History: R. and recr., Register, April, 2000, No. 532, eff. 7-1-00.

Comm 52.62 Disposal of sewage. (1) Each water-closet and urinal, and each lavatory or slop sink, located in a toilet room shall be connected with a sewer and water system, where such systems are available. In locations where a sewer system is not available, or cannot be made available, the disposal of human waste may be accomplished as follows:

(a) A private onsite wastewater treatment system, POWTS; or **Note:** For detailed requirements on POWTS see ch. Comm 83.

(b) Where the local conditions or situations make it impractical to install a POWTS, permanent or portable outdoor toilets, as described in s. Comm 52.63, or other sanitation systems or

devices, as described in ch. Comm 91, may be used; provided that in the case of places of employment for more than 10 persons, schools larger than 2 rooms, and apartment houses, water-flush toilets as herein described shall be provided, unless outdoor toilets or other sanitation systems or devices are permitted in writing by the department.

History: 1-2-56; am. (1) (b), Register, August, 1993, No. 452, eff. 3-1-94; r. and recr. (1) (a) and am. (1) (b), Register, April, 2000, No. 532, eff. 7-1-00.

Comm 52.63 Permanent and portable outdoor toilets. (1) PERMANENT OUTDOOR TOILETS. (a) Permanent outdoor toilets consisting of composting toilet systems, incinerating toilets, or privies shall comply with ss. Comm 52.50 to 52.59 and ch. Comm 91.

(b) A permanent outdoor toilet shall be provided with a suitable approach, such as a concrete, gravel or cinder walk.

(c) All windows, ventilators and other openings of permanent outdoor toilets shall be screened to prevent the entrance of flies, and all doors shall be self-closing.

Note: Chapter Comm 91 contains requirements for the design, construction, installation and maintenance of the storage chambers for privies.

(2) PORTABLE RESTROOMS. (a) No portable restroom may be erected or maintained within 50 feet of any well, 10 feet of the line of any street or public thoroughfare, unless vehicular traffic has been temporarily detoured while the portable restroom is in use, 5 feet of the property line between premises or 25 feet of a door, window or other outdoor openings of any building.

(b) A portable restroom shall be stabilized to prevent the unit from tipping over.

(c) A portable restroom shall be located with an approach such that access is unobstructed, and free of brush, debris and standing water.

(d) For specialty event centers without permanent sanitary fixtures in numbers as required under s. Comm 62.992 (2), portable restrooms may be used to meet the number required for the event, using capacity or seating capacity.

Note: Chapter Comm 91 contains requirements for the storage chamber of portable restrooms into which human waste is to be deposited.

Note: The servicing and disposal of the contents of portable restrooms is addressed under chs. NR 113 and 114.

History: 1-2-56; am. (1) (intro.) to (e), cr. (2), Register, August, 1993, No. 452, eff. 3-1-94; r. and recr., Register, April, 2000, No. 532, eff. 7-1-00.

Comm 52.64 Maintenance and housekeeping.

(1) MAINTENANCE OF TOILETS. Every toilet room, and every part thereof, including walls, floor, ceiling and fixture therein, shall be kept clean, efficient, and in good repair.

(2) PAPER. In every toilet room, sufficient toilet paper made of material which will not interfere with the operation of the system or obstruct the fixtures, shall be provided.

(3) DEFACEMENT. Indecent or suggestive marks, pictures, or words are forbidden in toilet rooms, and such defacement when found shall be removed at once.

(4) SERVICE CLOSETS. In buildings having 5 or more fixtures (water closets and/or urinals) a service closet shall be provided conforming with the requirements for toilet rooms.

(a) The service closet shall be supplied with mop, broom, bucket, soap, toilet paper, toweling and other equipment for sanitary upkeep of toilet rooms.

History: 1-2-56; r. and recr. (4), Register, October, 1967, No. 142, eff. 11-1-67.

Chapter Comm 53

STRUCTURAL REQUIREMENTS

Comm 53.01 Scope.

Subchapter I—Minimum Allowable Loads

- Comm 53.10 Dead loads.
- Comm 53.11 Live loads.
- Comm 53.12 Wind loads.
- Comm 53.13 Impact loads.
- Comm 53.14 Horizontal and longitudinal crane forces.
- Comm 53.15 Load combinations.
- Comm 53.16 Stability.
- Comm 53.17 Interior nonload-bearing walls and partitions.

Subchapter II—Foundations

- Comm 53.20 General.
- Comm 53.21 Soil bearing capacity.
- Comm 53.22 Unprepared fill material, organic material.
- Comm 53.23 Frost penetration.
- Comm 53.24 Piling.
- Comm 53.25 Settlement.
- Comm 53.26 Protection of adjoining property.
- Comm 53.27 Cut or fill slopes.
- Comm 53.28 Pole foundations.

Subchapter III—Masonry

- Comm 53.30 General.
- Comm 53.31 Materials.
- Comm 53.311 Masonry units.
- Comm 53.312 Mortar.
- Comm 53.313 Masonry grout.
- Comm 53.314 Cementitious materials.

- Comm 53.315 Water.
- Comm 53.316 Reinforcing, ties and anchors.
- Comm 53.32 Design.
- Comm 53.321 Types of masonry.
- Comm 53.322 Empirical method of design.
- Comm 53.323 Engineered masonry.
- Comm 53.33 Construction.
- Comm 53.34 Miscellaneous design-construction details.
- Comm 53.35 Tests.
- Comm 53.36 Veneer, furring and trim.

Subchapter IV—Concrete

- Comm 53.40 Concrete requirements.
- Comm 53.41 Gypsum concrete requirements.

Subchapter V—Metals

- Comm 53.50 Structural steel requirements.
- Comm 53.51 Cold formed steel requirements.
- Comm 53.52 Steel joist requirements.
- Comm 53.53 Structural welding of steel.
- Comm 53.54 Aluminum framing requirements.
- Comm 53.55 Stainless steel requirements.
- Comm 53.56 Steel cable requirements.

Subchapter VI—Wood and Wood Fiber Products

- Comm 53.60 General.
- Comm 53.61 Materials and design of structural elements.
- Comm 53.62 Special systems.
- Comm 53.63 Minimum construction requirements.
- Comm 53.64 Wood foundations.

History: Chapter Ind 53 as it existed on December 31, 1974, was repealed and a new chapter Ind 53 was created Register, July, 1974, No. 223, effective January 1, 1975; chapter Ind 53 was renumbered to be chapter ILHR 53 effective 1-1-84.

Note: Chapter ILHR 53 was renumbered to be chapter Comm 53 under s. 13.93 (2m) (b) 1., and corrections were made under s. 13.93 (2m) (b) 7., Stats., Register, September, 1998, No. 513.

Comm 53.01 Scope. This chapter provides the minimum requirements for the structural design of all buildings, structures and foundations to provide safe support of all dead loads, superimposed live and special loads, without exceeding the prescribed allowable stresses or departing from accepted engineering practice.

Note: References. All standards referred to in this chapter will be identified by the acronym designation and the number of the standard.

History: Cr. Register, July, 1974, No. 223, eff. 1-1-75.

Subchapter I—Minimum Allowable Loads

Comm 53.10 Dead loads. All buildings and structures, and parts thereof, shall be designed and constructed to support the actual dead weight of all component members in addition to the weight of partitions, ceiling finishes, floor finishes, stairways, safes and service equipment such as sprinkler systems, plumbing stacks, heating and air conditioning equipment, electrical equipment, elevators, flues and similar fixed equipment which become a part of the building.

Note: Unless the project owner submits a written application for waiver, the department will consider 3 pounds per square foot as minimum service equipment load.

History: Cr. Register, July, 1974, No. 223, eff. 1-1-75.

Comm 53.11 Live loads. (1) LIVELOADS. All buildings and structures, and parts thereof, shall be designed and constructed to support the superimposed live loads, specified in Table 53-I, uniformly distributed in pounds per square foot of horizontal area. These load requirements shall be considered only as a minimum. In every case where the loading is greater than this minimum, the design of the building or structure, or part thereof, shall be for the actual load and loading conditions.

The most severe distribution, concentration and combination of design loads and forces shall be taken into consideration.

**TABLE 53-I
FLOOR LOADINGS**

Occupancy	PSF
(a) Business	
1. Offices	50
2. Offices with heavy business machines, heavy files, bookstacks	100
(b) Mercantile	
1. Retail stores, shops, banks, restaurants, taverns, funeral homes	100
2. Wholesale stores	125
(c) Industrial	
1. Manufacturing, light	100
2. Manufacturing, heavy	150
(d) Storage	
1. Warehouse, light	125
2. Warehouse, heavy	250
3. Paper storage	
a. Compact	50 psf per ft. of ht.
b. Loose	30 psf per ft. of ht.
4. Garages—storage or repair	80
or 8,000 pound axle load in any possible position (which ever produces larger stresses).	

TABLE 53-I (continued)

Occupancy	PSF
5. Parking decks	
a. All areas for passenger cars	50
b. Top floors, if open to sky, shall be designed for 50% of the roof load specified in sub. (4) in addition to	50
c. Express lanes and ramps with a slope of 12% or more, the vertical loading (50 psf) shall be increased by 25%	
d. All areas for trucks and buses or 8,000 pound axle load in any possible position (which ever produces larger stresses)	80
(e) Assembly areas	
1. Armories, drill rooms	150
2. Assembly halls, auditoriums, lecture halls, churches, lodge rooms, theaters, court-rooms, balconies, with:	
a. Fixed seats	60
b. Movable seats	100
3. Dance floors, gymnasiums, exhibition rooms, passenger stations, skating rinks, restaurant serving and dining areas	100
4. Recreational areas such as bowling alleys and pool rooms	75
5. Floors supporting portable reviewing stands and assembly seating facilities with vertical dead load less than 15 pounds per square foot	100
6. Stage floors	150
7. Floors supporting portable reviewing stands and assembly seating facilities with vertical dead load of 15 pounds per square foot or more plus the actual vertical dead load of reviewing stand or assembly seating facility	100
(f) Educational	
1. Schools and related facilities	
a. Classrooms, study rooms, laboratories, display areas, offices	50
b. Floors of open plan schools	75
c. Industrial arts, home economics, music and band rooms	80
d. Gymnasiums, cafeteria areas	100
2. Libraries (public or in schools)	
a. Reading areas	60
b. Stack areas (20 psf per foot of height) but not less than	150
3. Museums and art galleries	80
(g) Residential	
1. Apartments, dormitories, guest rooms in hotels and motels	40

TABLE 53-I (continued)

Occupancy	PSF
2. Storage in apartment buildings	80
3. Attic storage within living units	20
(h) Institutional	
1. Ward and private rooms in hospitals, nursing homes, asylums, cells in penal institutions	40
2. Operating rooms in hospitals, clinics	60
(i) Miscellaneous (applies to all occupancies above)	
1. Stairways, corridors, vestibules, lobbies	
a. in residential and institutional buildings	80
b. in all other buildings	100
2. Rest rooms and toilet rooms in public places	50
3. Equipment rooms (heating-ventilating, mechanical, electrical) equipment weight plus 40 psf, but not less than	75
4. Structural sidewalks and promenade decks	
a. with no vehicular restriction or 12,000 pounds concentrated load in any position	250
b. with vehicular restriction	100
5. Walkways and elevated platforms, other than exitways, and their supports serving as access to equipment rooms and other normally unoccupied areas	60
6. Accessible, nonstorage attics and catwalks	25

(2) LOADS NOT SPECIFIED IN TABLE 53-I. See s. Comm 53.11 (1).

(3) LIVE LOAD REDUCTIONS. (a) No reduction of live load shall be allowed in the design of any slab or joist.

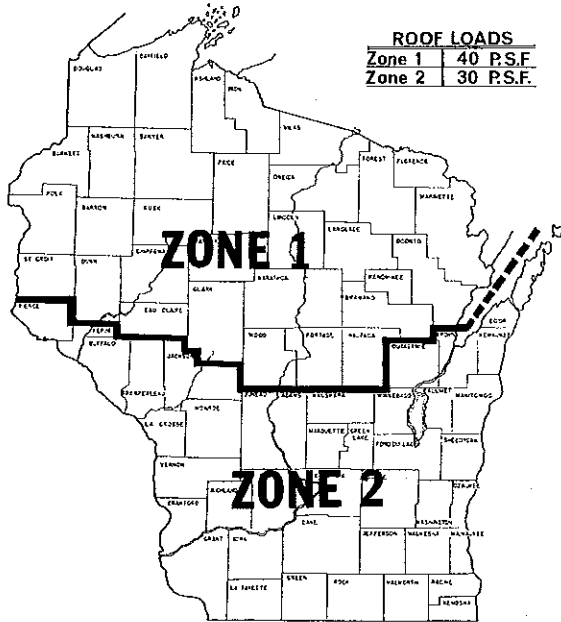
(b) No reduction of live load shall be allowed in the occupancies mentioned in Table 53-I sub. (1) (d) storage and (e) assembly areas.

(c) For determining the total live load carried by foundations, columns, piers, and walls, the following reductions can be applied to the entire floor area tributary to these members:

carrying the roof	0%
carrying 1 floors and roof	0%
carrying 2 floors and roof	10%
carrying 3 floors and roof	20%
carrying 4 floors and roof	25%
carrying 5 floors and roof	30%
carrying 6 floors and roof	35%
carrying 7 floors and roof	40%
carrying 8 floors and roof	45%
carrying 9 or more floors and roof	50%

(d) Except for roofs, a reduction in live load of one percent per 20 square feet is allowed for beams and girders which have a tributary area in excess of 150 square feet. The maximum reduction should not exceed 15% and such reduction shall not be carried into the structural members supporting these beams and girders.

(4) ROOF LOADS. Roof structural members subject to snow accumulation shall be designed for all of the following roof load distributions.



Zone Map for Roof Loads

(a) 1. Except as provided in subd. 2., full load as indicated in the zone map for roof loads distributed over the entire area. The loads shall be applied to the horizontal projection of the roof.

2. a. Roofs, except of greenhouses, with an unobstructed slippery surface such as glass, plastic, metal, slate or similar material that will allow snow to slide off the eaves and having a slope (α) exceeding 30°, may be designed for a load determined by multiplying the roof load specified in subd. 1., by a slope factor (C) using the following formula:

$$C_R = 1.0 - \left(\frac{\alpha - 30^\circ}{40^\circ} \right)$$

b. Roofs of greenhouses and other similar glazed structures shall be designed in accordance with this section or s. Comm 62.96.

(b) Unbalanced or partial loading for the following conditions:

1. Full load on the leeward side and one-half load on the windward side of sloped roofs having a pitch of 15° or more;

2. Full load on the end span of continuous purlin members having a tributary area of 200 square feet or less and one-half on the remaining spans; and

3. a. Except as provided in subd. 3. b., full load on any one portion of the roof area and one-half on the remaining portion of the roof area, in a manner to produce the greatest effects on cantilever members and the anchor spans.

b. Cantilever roof framing design shall include anchorage and supports capable of providing stability for full load applied on the cantilever without relying upon possible live load on the anchor span.

(c) Nonuniform load caused by excess snow, ice or water accumulation at roof level elevation differences, parapets, canopies, valleys and similar areas.

1. The nonuniform snow loading shall be determined by multiplying the indicated roof load by a snow load coefficient (C_s) appropriate for the roof area considered.

$$S = C_s g$$

where S= design snow load, psf

g= roof live load as indicated in the zone map for roof loads [see par. (a)]

C_s= snow load coefficient

Note: Acceptable snow load distribution and coefficients (C) for typical roof configurations are given in Appendix A. Additional information can be found in the "Commentary on Snow Loads," in supplement No. 4 to the National Building Code of Canada.

2. The roof load shall be increased to account for the accumulation of drifting snow on the lower of multi-level roofs if the upper roof is part of the same building or of an adjacent building not more than 15 feet away.

(d) 1. Roof designs incorporating storm drain sizes less than those specified in s. Comm 82.36 (4) and (5), shall be investigated by calculation to determine if stability of the building or structure due to ponding is achieved.

2. When roof drains are needed to remove precipitation and are the sole means of water escape, there shall be placed in all parapet walls, scuppers or relief openings to prevent overloading of the roof.

Note: See Appendix A for further explanatory material.

History: Cr. Register, July, 1974, No. 223, eff. 1-1-75; am. (3) (d) and (4) (a), Register, December, 1974, No. 228, eff. 1-1-75; am. (1) (d) 5 b, Register, December, 1977, No. 264, eff. 1-1-78; r. and recr. (4), Register, January, 1980, No. 289, eff. 2-1-80; am. (1) (d) 5. b. and (e) 5., cr. (1) (e) 7. and (4) (e), r. and recr. (4) (a) 1., Register, December, 1981, No. 312, eff. 1-1-82; cr. (1) (g) 2., (i) 5. and 6., r. and recr. (4) (a) and (b), r. (4) (c), renum. (4) (d) and (e) to be (4) (c) and (d), Register, December, 1983, No. 336, eff. 1-1-84; correction in (4) (d) made under s. 13.93 (2m) (b) 7., Stats., Register, August, 1985, No. 356; am. (4) (a) 2. a. and (b) 3. b., table line g, r. and recr. (4) (a) 2. b., Register, March, 1991, No. 423, eff. 4-1-91; correction in (4) (b) 3. a. made under s. 13.93 (2m) (b) 7., Stats., Register, March, 2000, No. 531.

Comm 53.12 Wind loads. (1) LOADING. Every building (including all components of the exterior wall) and structure shall be designed to resist a minimum total wind load in accordance with the following table:

Up to 50 feet	20 psf
Over 50 to 100 feet	25 psf
Over 100 to 150 feet	30 psf
Over 150 to 200 feet	35 psf
Over 200 feet	40 psf

The wind pressure shall be taken on the gross area of the vertical projection of the building or structures facing the wind. No allowance shall be made for the shielding effect of other buildings and structures. For purposes of wind load design, the height shall be measured above the average level of the adjoining ground.

(2) UPLIFT AND SUCTION FORCES. Buildings and structures, including attachment of roof to building or structure and anchorage of building or structure to the foundation, shall be designed and constructed to withstand a wind pressure acting outward normal to the surface equal to the values set forth in sub. (1). These suction and uplift forces need not be considered as additive to the design wind loads in the overall analysis of the building or structure. Roof overhangs, eaves, cornices, canopies and buildings open on one or more sides shall be designed and constructed to withstand an upward pressure of at least 30 PSF, unless a higher value is indicated in sub. (1).

(3) OVERTURNING MOMENT. The overturning moment due to wind load shall not exceed 2/3 of the moment of stability due to dead load only, unless the building or structure is anchored to foundations of sufficient weight to resist this force. The weight of earth superimposed over footings may be used to calculate the dead load resisting moment. Sufficient diaphragm bracing, diagonal bracing or rigid connections between uprights and horizontal members shall be provided to resist distortions.

(4) **SHAPE FACTORS.** The following shape factors may be used for the design of structures such as chimneys, tanks and solid towers in conjunction with sub. (1).

<i>Horizontal cross-section</i>	<i>Shape factors</i>
square or rectangular	1.0
hexagonal or octagonal	0.8
round or elliptical	0.6

(5) **WIND LOAD ANALYSIS.** More exact wind load analysis will be acceptable if a recognized procedure is used.

Note: The department will accept recognized procedures such as, but not limited to Department of Navy, Bureau of Yards and Docks, NAVFACDM-2 (Dec. 1967); or "Wind Forces on Structures," by the Structural Division of ASCE Test Committee on Wind Forces (ASCE Transactions, Vol. 126, Part II, Paper No. 3269).

History: Cr. Register, July, 1974, No. 223, eff. 1-1-75; am. (2), Register, December, 1976, No. 252, eff. 1-1-77.

Comm 53.13 Impact loads. Structural elements carrying live loads which induce impact shall have the live loads increased by the following minimum percentages in the structural design consideration of the forces

For supports of elevators	100
For traveling crane support girders, monorail supports, and their connections:	
Cab operated cranes	25
Top running pendant operated cranes	10
Underhung and monorail cranes	25
For supports of light machinery	20
For supports of vibrating machinery or power driven units	50
For hangers supporting floors and balconies	33

History: Cr. Register, July, 1974, No. 223, eff. 1-1-75; r. and recr. (1), renum. (2) to be 53.14, Register, December, 1977, No. 264, eff. 1-1-78; am. Register, December, 1983, No. 336, eff. 1-1-84.

Comm 53.14 Horizontal and longitudinal crane forces. The lateral force on crane runways shall be equal to 20% of the sum of the crane capacity and the crane trolley (but exclusive of other parts of the crane). The force shall be assumed to be applied at the top of the rail, one-half on each side of the runway, and shall be considered acting in either direction normal to the runway rail. The longitudinal force (in the direction of rail) shall be taken as 10% of the maximum wheel loads of the crane applied at the top of the rail.

History: Cr. Register, July, 1974, No. 223, eff. 1-1-75; renum. from 53.13 (2), Register, December, 1977, No. 264, eff. 1-1-78.

Comm 53.15 Load combinations. Allowable stresses may be increased 33 1/3% when wind loads are acting in combination with dead, live and impact (if any) loads. The section computed on this basis shall be not less than that required for the design dead, live and impact (if any) loads, computed without the 33 1/3% stress increase. The most severe distribution, concentration and combination of design loads and forces shall be taken into consideration, as specified in s. Comm 53.11.

Note: See Appendix A for further explanatory material.

History: Cr. Register, July, 1974, No. 233, eff. 1-1-75, am. Register, December, 1975, No. 240, eff. 1-1-76; renum. from 53.14, Register, December, 1977, No. 264, eff. 1-1-78.

Comm 53.16 Stability. (1) GENERAL. (a) Provisions shall be made to assure stability of the structure as a whole and lateral, torsional and local stability of all structural parts.

(b) Instability, including sway effects or lateral displacement, produced by vertical loads or vertical and lateral loads acting on the structure shall be taken into account in the design of all structures and structural members.

(2) **CALCULATIONS AND TESTING.** (a) Calculations verifying structural stability shall be submitted under s. Comm 50.12 (4) (a) and (b) when requested.

(b) Bracing systems, for which the strength and stiffness cannot be calculated, shall be substantiated by test reports.

History: Cr. Register, December, 1983, No. 336, eff. 1-1-84.

Comm 53.17 Interior nonload-bearing walls and partitions. Interior nonload-bearing walls and permanent partitions more than 6 feet in height shall be designed to resist a lateral load of not less than 5 pounds per square foot of wall area. Movable or folding partitions are not required to meet the load criteria but shall be anchored to the supporting structure if their height exceeds 6 feet.

History: Cr. Register, December, 1983, No. 336, eff. 1-1-84.

Subchapter II—Foundations

Comm 53.20 General. All submittals for plan examination of new buildings or structures, and for the alteration of a permanent structure which requires changes in foundation loads and distribution, shall have the soil types and bearing capacities (indicating verified or presumptive) used in the design of footing and foundations shown on the plans. Sufficient records and data to establish the soil character, nature and load-bearing capacity shall be available to the department upon request.

History: Cr. Register, July, 1974, No. 223, eff. 1-1-75.

Comm 53.21 Soil bearing capacity. Bearing capacity of soils shall be determined by one of the following methods:

(1) **VERIFIED.** The soil shall be subjected to field or laboratory tests to determine its bearing capacity. A report, certified by a registered architect or registered professional engineer, shall be available to the department upon request.

(2) **PRESUMPTIVE.** (a) The type of soil under buildings shall be assigned a value not exceeding the bearing capacity, in pounds per square foot, as specified in Table 53-II. The type of soil shall be determined by explorations made at or adjacent to the site. The actual loading of the soil shall not exceed the specified bearing capacity unless verified by a written report as explained in sub. (1).

**TABLE 53-II
PRESUMPTIVE SOIL BEARING VALUES**

Type of Soil	PSF
1. Wet soft clay; very loose silt; silty clay s. Comm 53.21 (1)	Verified method
2. Loose fine sand; medium clay; loose sandy clay soils	2,000
3. Stiff clay; firm inorganic silt	3,000
4. Medium (firm) sand; loose sandy gravel; firm sandy clay soils; hard dry clay	4,000
5. Dense sand and gravel; very compact mixture of clay, sand and gravel	6,000
6. Rock	12,000

(b) The presumed soil bearing values shall be confirmed by exploring the type of soil to a depth of at least 5 feet below the footings during or before construction. The designer shall submit a report of confirmation to the department upon request.

(c) Where the bearing materials directly under a foundation overlie a stratum having smaller allowable bearing values, such smaller values shall not be exceeded at the level of such stratum.

History: Cr. Register, July, 1974, No. 223, eff. 1-1-75; am. (2) (b), Register, December, 1976, No. 252, eff. 1-1-77.

Comm 53.22 Unprepared fill material, organic material. No foundation of buildings or structures shall be placed upon unprepared fill material, organic soil, alluvial soil or mud unless evidence has been presented to the department showing that the proposed load will be adequately supported. This evidence shall be in the form of a written report and shall be based on soil analyses, load tests or other acceptable criteria.

Note: The decomposition of organic material in landfill sites established for the disposal of organic wastes may produce odorous, toxic and explosive concentrations of gas which may seep into buildings through storm sewers and similar underground utilities unless provisions are taken to release the gases to the atmosphere.

History: Cr. Register, July, 1974, No. 223, eff. 1-1-75.

Comm 53.23 Frost penetration. (1) DEPTH. Footings and foundations shall be placed below the frost penetration level, but in no case less than 42 inches below adjacent ground. Such footings shall not be placed over frozen material.

(2) FLOATING SLABS AND GRADE BEAMS. The edges of floating slabs and grade beams need not be installed below the minimum frost penetration provided adequate measures have been taken to prevent frost forces from damaging the structure.

(3) WALKS, STOOPS AND RAMPS ADJACENT TO REQUIRED EXITS. The edges of walks, stoops or ramps or the footing and foundation of walks, stoops or ramps need not be installed below the minimum frost penetration line provided adequate measures have been taken to prevent frost forces from damaging the structure or affecting the structure in such a manner as to obstruct the exit.

Note: Also see s. Comm 52.21—location and maintenance of exits.

History: Cr. Register, July, 1974, No. 223, eff. 1-1-75; r. and recr., Register, January, 1980, No. 289, eff. 2-1-80.

Comm 53.24 Piling. (1) GENERAL REQUIREMENT. Pile foundations shall be designed and installed to adequately transfer the structure loads to underlying or adjacent soil bearing strata.

(2) INSTALLATION. Piles shall be handled and installed to the required penetration by methods which leave their strength unimpaired and that develop and retain the required load bearing capacity. Any damaged pile shall be satisfactorily repaired or the pile shall be rejected.

(3) ALLOWABLE LOADS BASED ON SOIL CONDITIONS. (a) By driving formula. For individual pile design loads not exceeding 40 tons per pile, the safe working load may be determined by a recognized formula or by the following formula:

$$P = \frac{2WH}{S + I} \text{ for drop hammer}$$

$$P = \frac{2E}{S + 0.1} \text{ for double-acting hammer}$$

in which:

P = safe load (lbs.)

W = weight of striking part of hammer (lbs.)

H = fall of striking part of hammer (ft.)

E = manufacturer's rated energy (ft.—lbs.)

S = average penetration of pile under last 6 blows (inches/blow)

(b) Substantiation of higher allowable loads. Allowable loads greater than 40 tons will be permitted when substantiating data justifying such higher loads is submitted to the department by a foundation designer knowledgeable in the field of soil mechanics and pile foundations and familiar with the locale of the proposed project. Substantiating data such as test borings, laboratory test results, soil profiles, and pile load tests may be required by the department. The load test shall be in accordance with the procedure outlined in ASTM D-1143.

(c) Group pile action. When friction piles are placed in groups, consideration shall be given to the reduction of load per pile.

(d) Piles in subsiding areas. Where piles are driven through subsiding fills or other subsiding strata and derive support from underlying firmer material, consideration shall be given to the downward frictional forces which may be imposed on the piles by the subsiding upper strata.

(e) Lateral support. Water, air and fluid soils shall not be considered as offering lateral support to piles. In any other type of material the piles may be designed as a short column. Positive

permanent lateral support shall be provided at or near the top of all piles.

(4) ALLOWABLE LOADS BASED ON PILE MATERIAL STRENGTH.

(a) The compressive stress in any cross-section of a pile shall not exceed the normal allowable compressive stress of the material used for the pile, except as given in sub. (5). The piles may be designed as short columns except as stated in sub. (3) (e).

(b) End-bearing piles. For end-bearing piles more than 40 feet in length, it may be assumed that 75% of the load is carried by the tip, except for piles installed in a material referred to in s. Comm 53.22.

(c) Friction piles. For friction piles, the full load shall be computed at the cross section located at two-thirds of the embedded length of the pile measured up from the tip.

(5) TYPE OF PILES. (a) Timber piles. Timber piles shall conform to National Design Specifications, Part X. In addition, the tops of treated piles, at cutoff, shall be given 3 coats of hot creosote, followed by a coat of coal-tar pitch; and the cutoff shall be encased not less than 4 inches in concrete footing of the foundation.

(b) Precast concrete piles. Precast concrete piles shall be cast in one piece and shall attain a compressive strength of not less than 3,000 psi prior to driving. There shall be a minimum concrete covering of 2 inches over all reinforcing bars. Precast concrete piles shall be designed to resist stresses induced by handling, driving and super-imposed loads.

(c) Cast-in-place concrete piles. All concrete for cast-in-place piles shall develop a compressive strength of not less than 3,000 psi. Reinforcement shall have a concrete cover of one inch in cased piles and 2 inches in uncased piles.

1. **Uncased piles.** Cast-in-place piles in contact with earth shall be limited in length to 30 times the average diameter of the pile. The allowable compressive stress in concrete shall not exceed 0.33 f'c. The concrete shall be deposited in a shaft free of foreign matter in a continuous operation so as to insure a full sized pile without voids or segregation.

2. **Metal formed piles.** Cast-in-place piles in contact with a steel shell or casing shall have a minimum tip diameter of 8 inches and a minimum average diameter of 10 inches. The shell and casing shall be sufficiently strong to resist collapse and sufficiently watertight to exclude water and foreign material during the placing of concrete. The shell or casing cannot be considered as a load carrying part of the pile. The allowable compressive stress in concrete shall be as stated for uncased piles, but it may be increased to a maximum value of 0.40 f'c if the following conditions are satisfied:

a. The thickness of casing is not less than 0.0747 inches (14 ga AISI).

b. The casing is seamless or is provided with seams of strength equal to that of the casing.

c. The pile diameter is not greater than 18 inches.

(d) Concrete-filled pipe and tapered tubular piles. Concrete-filled pipe and tapered tubular piles may be driven open-ended or closed-ended. Pipe or tapered tube piles driven with closed ends shall be treated as a cast-in place concrete pile with metal casing and shall be governed by the same regulations applicable thereto with suitable load-bearing allowance made for the metal casing. When driven open-ended to rock, no concrete shall be deposited until the pipe is cleaned free of all soil or loose rock chips and satisfactory proof furnished of the condition of the rock. The allowable stress in steel is .35 Fy but shall not exceed 12,600 psi. The minimum wall thickness of all load-bearing pipe, tube and shells shall be 1/10 inch. When the soil surrounding the pile contains destructive chemical elements, the pile shall be provided with an approved protective jacket or coating which will not be rendered ineffective by driving.

(e) *Structural steel piles.* No section shall have a nominal thickness of metal less than 3/8 inch. When an H-shaped section is used, the flange projection shall not be more than 14 times the minimum thickness of metal. The steel stress shall not exceed 0.35 Fy.

History: Cr. Register, July, 1974, No. 223, eff. 1-1-75; am. (3) (b) and (5) (a), Register, March, 1991, No. 423, eff. 4-1-91.

Comm 53.25 Settlement. Where footings or floating slabs are placed upon clays or other materials which are subject to settlement, an analysis for such buildings shall include consideration of total and differential settlements anticipated.

History: Cr. Register, July, 1974, No. 223, eff. 1-1-75.

Comm 53.26 Protection of adjoining property.

(1) Any property owner (owner of an interest in land) making or causing an excavation to be made to a depth of 12 feet or less, below the grade, shall protect the excavation so that the soil of adjoining property will not cave in or settle, but shall not be liable for the expense of underpinning or extending the foundation of buildings on adjoining properties where the excavation is not in excess of 12 feet in depth. Before commencing the excavation the person making or causing the excavation to be made shall notify in writing the owners of adjoining buildings not less than 30 days before such excavation is to be made and that the adjoining buildings should be protected. The owners of the adjoining property shall be given access to the excavation for the purpose of protecting such adjoining buildings.

(a) *Exception.* The 30-day time limit for written notification may be waived if such waiver is signed by the owner of adjoining properties.

(2) Property owners (owners of an interest in land) making or causing an excavation to be made exceeding 12 feet in depth below the grade shall protect the excavation so that the soil of adjoining property will not cave in or settle, and shall extend the foundation of any adjoining buildings below the depth of 12 feet below grade at their own expense. The owner(s) of the adjoining buildings shall extend the foundations of their buildings to a depth of 12 feet below grade at their own expense as provided in the preceding paragraph.

History: Cr. Register, March, 1978, No. 266, eff. 3-1-78.

Comm 53.27 Cut or fill slopes. Cuts or fills adjacent to any building, structure or property line shall be so constructed or protected that they do not endanger life and/or property. Permanent cut slopes shall not be steeper than 1 1/2 horizontal to one vertical and permanent fill slopes shall not be steeper than 2 horizontal to one vertical unless substantiating data justifying steeper slopes are submitted.

History: Cr. Register, July, 1974, No. 223, eff. 1-1-75; r. (2), renum. (1), Register, January, 1994, No. 457, eff. 2-1-94.

Comm 53.28 Pole foundations. Structures that use poles embedded in earth or embedded in concrete footings in the earth to resist axial and lateral loads shall have their depth of embedment determined as specified in this section.

(1) **CONSTRUCTION BACKFILL REQUIREMENTS.** The space around the pole shall be backfilled in accordance with one of the following methods:

(a) The hole shall be made 4 inches larger than the diameter or diagonal dimension of rectangular or square poles. It shall be backfilled with 2,000 psi concrete.

(b) The backfill shall be of thoroughly compacted clean sand.

(2) **ALLOWABLE LATERAL SOIL PRESSURE.** In the design of nonrestrained and restrained poles, unless a more exact soil analysis method is used, the allowable passive soil pressure shall be determined in accordance with Table 53-III.

TABLE 53-III
ALLOWABLE LATERAL SOIL PRESSURE

Soil Types (see Table 53-II) grade ²	Allowable Passive Soil Pressure (p) ¹ psf per foot of depth below grade ³	
	1 and 2 (not well drained)	100
2 (well drained)	150	
3 (well drained)	200	
4 (well drained)	300	
5 and 6 (well drained)	400	

1. S₁ and S₂ values shall not exceed 12 times the allowable passive soil pressure (p).

2. Values may be increased 33 1/3% for wind loads.

3. Where 1/2-inch horizontal movement of the pole at ground surface can be tolerated, the values shown in Table 53-III may be increased 100%, provided the individual poles are spaced a minimum distance of 6 times B center to center.

(3) **DESIGN-NONRESTRAINED POLES.** The following formula shall be used in determining the depth of embedment required to resist lateral loads where no restraint is provided at the ground surface, unless other methods are approved by the department.

$$d = \frac{A}{2} \left(1 + \sqrt{1 + \frac{4.36h}{A}} \right)$$

where: d = depth of embedment, ft.

$$A = \frac{2.34 P}{S_1 B}$$

P = applied horizontal force on pole, lb.

$$S_1 = pd/3, \text{ see Table 53-III}$$

Note: For first approximation of "d", the following formula may be used:

$$d = \sqrt[3]{\frac{12hP}{B_p}}$$

B = diameter of concrete casing, ft.; when noncased in concrete, diameter or diagonal dimension of square or rectangular pole, ft.

h = height above the ground, in feet, at which the force "P" is applied. If the pole has fixity at the top, such as provided by a knee brace, the force "P" acts at the inflection point. The inflection point may be assumed at 2/3 of the distance from the ground to the knee brace for round poles, or 1/2 of the distance from the ground to the knee brace for square poles.

p = allowable lateral passive soil pressure, psf.

Note: When a frame analysis is used, h = M/P, where M = bending moment on the pole at the ground surface.

(4) **DESIGN-RESTRAINED POLES.** Where restraint is provided at the ground surface, such as a rigid floor or pavement, the depth of embedment shall be in accordance with the following formula:

$$d = \sqrt{\frac{4.25hP}{S_3 B}} \text{ where : } S_3 = pd, \text{ see Table 53-III}$$

(5) **PRESERVATION.** All poles subject to moisture shall be treated with a preservative. Preservative treatment shall be in accordance with AWPA C2 or AWPA C4. All poles treated for preservation shall bear the mark of a quality control certification agency.

History: Cr. Register, July, 1974, No. 223, eff. 1-1-75; am. (2) and (3), cr. (4), Register, December, 1976, No. 252, eff. 1-1-77; renum. (2), (3) and (4) to be (3), (4) and (5), cr. (2), Register, December, 1977, No. 264, eff. 1-1-78; reprinted to correct error in (3), Register, December, 1985, No. 360; r. and recr. (5), Register, March, 1991, No. 423, eff. 4-1-91.

Subchapter III—Masonry

Comm 53.30 General. (1) SCOPE. The requirements of ss. Comm 53.30 through 53.36 herein shall apply to the design, construction and materials used in all masonry and similar work under this code.

(2) **DEFINITION.** Masonry as used herein shall be considered as any built-up construction or combination of building units or

materials of clay, shale, concrete, stone, gypsum, glass, metal or other approved units.

(3) **DIMENSIONS.** Dimensions specified herein are nominal unless otherwise stated. The actual dimensions may vary from the nominal by the thickness of a mortar joint, but not more than one-half inch.

History: Cr. Register, July, 1974, No. 223, eff. 1-1-75.

Comm 53.31 Materials. (1) GENERAL REQUIREMENTS. Components used in the construction of masonry shall be as required in ss. Comm 53.311 through 53.316.

(2) **LABELING.** All packaged materials shall be clearly identified by name (portland cement, masonry cement, lime, gypsum, etc.) and applicable standards which are met.

History: Cr. Register, July, 1974, No. 223, eff. 1-1-75.

Comm 53.311 Masonry units. (1) GENERAL. (a) *Solid and hollow units.* A solid masonry unit is a unit whose net cross-sectional area in every plane parallel to the bearing surface is 75% or more of its gross cross-sectional area measured in the same plane. A hollow masonry unit has a net cross-sectional area less than 75% of its gross cross-sectional area.

(b) *Quality.* All masonry units shall be free from cracks, laminations and other defects or deficiencies, including admixtures and coatings, which may interfere with proper laying of the unit or impair the strength or permanence of the structure.

(c) *Used masonry units.* Masonry units may be reused when clean, whole and conforming to requirements for new masonry units.

(d) *Marking requirements.* Masonry units shall be of distinctive design or appearance, or marked so that the manufacturer is identified, as required by the department.

(e) *Surface condition at time of use.* Every masonry unit shall have all surfaces, to which mortar or grout is to be applied, capable of developing the required strength and bond. Coating or facings permitted and applied to masonry unit surfaces prior to their installation shall not supersede this requirement.

(f) *Positioning in structure.* Hollow masonry units shall be laid only in positions as tested for compliance.

(2) **CLAY AND SHALE UNITS.** Clay and shale units shall be made of burned clay or shale or mixtures thereof with or without admixtures.

(a) *Solid units (brick).* Units shall conform to grade SW requirements of ASTM C-62.

(b) *Hollow units (tile and hollow brick).* 1. Load-bearing units. Units for use in load-bearing and exterior walls shall con-

form to grade LBX requirements of ASTM C-34 or grade SW requirements of ASTM C-652.

2. Nonload-bearing units. Units for use in nonload-bearing partitions shall be specially marked and shall conform to the requirements of ASTM C-56. Such units may also be used for non-structural purposes in concrete floor construction.

3. Units for floor construction. Units for structural use in floor construction shall conform to grade FT 1 requirements of ASTM C-57.

(3) **CONCRETE UNITS.** Concrete units shall be made with portland cement, water and suitable mineral aggregates, with or without admixtures.

(a) *Solid units.* 1. Small units (brick). Units shall conform to grade N requirements of ASTM C-55.

2. Large units (solid block). Units shall conform to grade N requirements of ASTM C-145.

(b) *Hollow units (blocks).* Units shall conform to grade N requirements of ASTM C-90.

(4) **NATURAL STONE.** All natural building stone for use in masonry shall be sound and free from loose or friable inclusions, and shall meet the strength and fire resistance requirements for the proposed use. Where the cleavage plane of stone units is pronounced, the stone shall be laid only on its natural bed. Stone exposed to soil, weather or frost action shall be such that the strength and structure of the stone will not be affected when so exposed.

(5) **CAST STONE.** Units covered under this category are homogeneous or faced, dry cast concrete products other than conventional concrete masonry units (brick or block), but of similar size.

(a) *Composition.* Units shall be made with portland cement, water and suitable mineral aggregates, with or without admixtures, and reinforced if required.

(b) *Standards.* Units shall have a minimum compressive strength of 6500 psi and a maximum water absorption of 6% when tested as 2 x 2 inch cylinders or cubes.

(6) **ARCHITECTURAL PRECAST CONCRETE.** Units covered under this category are homogeneous or faced, wet cast nonload-bearing concrete products. Load-bearing precast concrete units shall conform to the requirements of s. Comm 53.40.

(a) *Composition.* Units shall be made with portland cement, water and suitable aggregates, with or without admixtures, and reinforced as required.

(b) *Standards.* Units shall conform to the requirements of Table 53-IV.

**TABLE 53-IV
ARCHITECTURAL PRECAST CONCRETE PHYSICAL REQUIREMENTS**

Use	Compressive Strength† Minimum (psi)		Water Absorption Maximum (%)	Purposefully Entrained Air Minimum (%)
	Avg. of 3	Individual		
Exposed to freeze-thaw cycles (exterior)	4,500	3,800	8	3
All others (interior)	3,500	3,000	10	—

†Compressive strength shall be determined by procedures outlined in ASTM C-39 or C-42.

(7) **GYPHUM UNITS.** Units shall conform to the requirements of ASTM C-52. Gypsum units shall not be used in exterior or load-bearing walls or locations exposed to frequent or continuous wetting.

History: Cr. Register, July, 1974, No. 223, eff. 1-1-75; am. (8), Register, December, 1978, No. 276, eff. 1-1-79; am. (2), (3), table and (7), r. (8), Register, March, 1991, No. 423, eff. 4-1-91.

Comm 53.312 Mortar. (1) GENERAL. Mortar as used herein shall be considered as a mixture containing cementitious materials used to permanently bond masonry or other structural elements.

(2) **MORTAR FOR UNIT MASONRY.** (a) *Composition.* Conventional mortar shall be composed of cementitious materials, fine aggregates and water. Suitable admixtures are allowed.

(b) *Standards.* All materials used as ingredients in mortar when delivered to the mixer shall conform to the requirements outlined below:

1. Cementitious materials. See s. Comm 53.314.

2. Aggregates. Aggregates shall conform to the following requirements and to the requirements of ASTM C-144.

a. Aggregates shall be graded within the limits of Table 53-V.

b. The aggregate shall have not more than 50% retained between any 2 consecutive sieves of those listed in Table 53-V, nor more than 25% between the No. 50 and No. 100 sieves.

TABLE 53-V

MASONRY SAND GRADATION REQUIREMENTS

Sieve Size	Percentage Passing	
	Natural Sand	Manufactured Sand
No. 4	100	100
No. 8	95 to 100	95 to 100
No. 16	70 to 100	70 to 100
No. 30	40 to 75	40 to 75
No. 50	10 to 35	20 to 40
No. 100	2 to 15	10 to 25
No. 200	—	0 to 10

c. If the fineness modulus varies by more than 0.20 from the value assumed in selecting proportions for the mortar, suitable adjustments shall be made in proportions to compensate for the change in grading.

3. Water. See s. Comm 53.315.

4. Admixtures. Where metal ties, anchors or reinforcement are imbedded in masonry, chloride, nitrate and sulphate base salts or materials containing same shall not be used in masonry construction.

(c) Requirements. Mortar for masonry shall conform to the property requirements of Table 53-VI and to the requirements of ASTM C-270 unless otherwise noted in this section. If

approved laboratory testing is not conducted to indicate compliance with Table 53-VI, the mortar mix shall be restricted to the provisions of Table 53-VII.

TABLE 53-VI

MORTAR PROPERTY REQUIREMENTS

Mortar Type	Compressive Strength [†]	Water Retention	Air Content
	Min. (psi)	Min. (%)	Max. (%)
M	2,500	75	18
S	1,800	75	18
N	750	75	18
O	350	75	18

[†]See s. Comm 53.35 (3).

(3) GYPSUM MORTAR. (a) Standards. Gypsum mortar shall be composed of one part of unfibred calcined neat gypsum to not more than 3 parts sand by weight, with sufficient water added for workability.

(b) Use restrictions. Gypsum mortar shall be used only with gypsum tile and block units or as fireproofing.

(4) MISCELLANEOUS MORTARS. (a) High bond mortars. See s. Comm 50.19 for all such mortars, glues and special additives.

(b) Special use mortars. See Table 53-VIII.

(5) BOND. It is required that sufficient bond be developed to hold the masonry assemblage together and let it act as a single unit.

Note: Initial rate of absorption of masonry units and quantity of entrained air in mortar are factors affecting bond strength.

(6) MORTAR USE. Masonry shall be laid in mortar of the types listed in Table 53-VIII.

TABLE 53-VII

MORTAR PROPORTION RESTRICTIONS

	Cementitious Materials (Proportions by Volume)			Aggregate (Measured in a damp loose condition)
	Mortar Type			
	Portland Cement	Masonry Cement	Lime	
Lime Cement Mortar				
M	1	—	1/4	Not less than 2-1/4 and not more than 3 times the sum volumes of cementitious materials.
S	1	—	over 1/4 to 1/2	
N	1	—	over 1/2 to 1-1/4	
O	1	—	over 1-1/4 to 2-1/2	
Masonry Cement Mortar				
M	1	1	—	Not less than 2-1/4 and not more than 3 times the sum volumes of cementitious materials.
S	1/2	1	—	
N	—	1	—	
O	—	1	—	

TABLE 53-VIII
MORTAR USE REQUIREMENTS

Kind of Masonry	Types of Mortar Permitted
Load-bearing or nonload-bearing masonry in contact with earth	M or S
All other load-bearing masonry .	M, S or N
Nonload-bearing masonry in exterior and exposed locations where a high degree of resistance to frost action is desired	M, S or N
All other nonload-bearing walls and partitions	M, S, N or O
Fireproofing	M, S, N, O or gypsum
Special masonry:	
Gypsum partition tile or block . .	Gypsum
Firebrick or tile	Refractory air setting
Stack or chimney walls	Composed of portland cement, hydrated lime putty and aggregate

History: Cr. Register, July, 1974, No. 223, eff. 1-1-75; am. (4) (a), Register, December, 1978, No. 276, eff. 1-1-79; am. (2) (b) 2. intro. and (c), Register, March, 1991, No. 423, eff. 4-1-91.

Comm 53.313 Masonry grout. Masonry grout for non-engineered masonry shall be type M, S or N mortar, as used in the construction, to which water is added to produce a consistency for pouring without segregation.

Note: Masonry grout for reinforced masonry shall conform to the requirements of ASTM C-476.

History: Cr. Register, July, 1974, No. 223, eff. 1-1-75.

Comm 53.314 Cementitious materials. (1) PORTLAND CEMENT. Portland cement shall conform to the requirements of ASTM C-150.

(2) MASONRY CEMENT. Masonry cement shall conform to the requirements of ASTM C-91.

(3) HYDRATED LIME. Hydrated lime shall conform to Type S requirements of ASTM C-207.

(4) GYPSUM. Gypsum shall conform to the requirements of ASTM C-22.

History: Cr. Register, July, 1974, No. 233, eff. 1-1-75; am. Register, March, 1991, No. 423, eff. 4-1-91.

Comm 53.315 Water. Water shall be clean and free from injurious amounts of oil, acid, alkali, salt, organic matter and other deleterious substances.

History: Cr. Register, July, 1974, No. 223, eff. 1-1-75.

Comm 53.316 Reinforcing, ties and anchors. (1) REINFORCING BARS. Reinforcing bars shall conform to the requirements of ASTM A-165, A-616 and A-617.

(2) CONTINUOUS JOINT REINFORCEMENT. (a) Material. Ties shall be fabricated from the equivalent of cold drawn wire conforming to the requirements of ASTM A-82.

(b) Coating. Ties in exterior walls and potentially wet areas shall have noncorrodible cross wires for the intended use. Conformance with Class 3 requirements of ASTM A-116 is acceptable.

(c) Assembly. Ties shall consist of the equivalent of at least 2 No. 9 steel wire gage longitudinal wires or rods with No. 9 steel wire gage cross wires or rods spaced not over 16 inches apart along each longitudinal wire or rod electrically flush or butt welded to tie the outside wires or rods together and provide mechanical bond.

(d) Limitations. Ties shall be of such dimensions that they provide the following:

1. Overlap of at least 6 inches at splices.
2. Engagement of both adjacent wythes; out-to-out spacing of side rods to be approximately 2 inches less than the total wall thickness.
3. Minimum actual cover over all but the cross wires or rods of 5/8 inch clear from all masonry unit faces and their joint surfaces.

(3) INDIVIDUAL TIES AND ANCHORS. (a) Material. Ties and anchors shall be fabricated from steel, brass, bronze or other approved material. See s. Comm 53.322 (5) (c) 1.b.

(b) Coating. Ties and anchors for use in exterior walls and potentially wet areas shall be noncorrodible for the intended use. Zinc coating (hot dip) conforming to the requirements of ASTM A-153 is acceptable.

(c) Limitations. Ties and anchors shall be of such a dimension as to engage masonry units a minimum of 2 inches on each wythe in which the tie is placed and retain a minimum actual cover of 5/8-inch clear from all exposed masonry faces and joints.

History: Cr. Register, July, 1974, No. 223, eff. 1-1-75; am. (1), (2) (a) and (b), (3) (b), Register, March, 1991, No. 423, eff. 4-1-91.

Comm 53.32 Design. (1) GENERAL REQUIREMENTS. Design of plain (non-reinforced) masonry shall be based either on the empirical method and limitations of s. Comm 53.322 or on a detailed engineering analysis according to the provisions of s. Comm 53.323. Design of reinforced masonry shall be based on the provisions of s. Comm 53.323.

(2) PRACTICE. All masonry shall be designed with adequate strength and proportions to support all intended superimposed loads, resist all vertical or horizontal loads as required by this code, and comply with the fire-resistive construction requirements set forth in s. Comm 51.04.

History: Cr. Register, July, 1974, No. 223, eff. 1-1-75.

Comm 53.321 Types of masonry. (1) VENEER, FURRING AND TRIM. Veneer, furring and trim comprise a facing of weather-resistant non-combustible materials securely attached to a backing, but not so bonded as to exert common action under load. See s. Comm 53.36 for requirements.

(2) PANEL WALL. A panel wall is composed of weather resistant noncombustible large masonry units, or small masonry units prefabricated into larger assemblages, securely anchored to the framing of the structure.

(3) SINGLE WYTHE WALL. A single wythe wall is one masonry unit in thickness and is built of conventional size masonry units.

(4) MULTI-WYTHE WALL. A multi-wythe wall is composed of 2 or more wythes of conventional size masonry units of the same or different materials all tied or bonded together.

(a) Grouted wall. A grouted wall is a multi-wythe wall with all spaces between wythes solidly filled with masonry grout, as defined in s. Comm 53.313.

(b) Slushed or parged wall. A slushed or parged wall is a multi-wythe wall with all spaces between wythes nominally filled with mortar.

(c) Hollow wall (includes conventional cavity wall). A hollow wall is a multi-wythe wall with an air space maintained between wythes. A water-repellent or water-resistant insulation may be placed between wythes. The description of a hollow wall is determined by its nominal out-to-out dimension.

(5) SPECIAL WALLS. (a) Stack or chimney walls. See s. Comm 64.46 and Table 53-VIII for general requirements.

(b) Special use walls. See s. Comm 53.34 for special requirements.

History: Cr. Register, July, 1974, No. 223, eff. 1-1-75.

Comm 53.322 Empirical method of design.

(1) STRESSES. (a) *General.* 1. In determining the stresses in masonry, the effects of all loads and conditions of loading and the influence of all forces affecting the design and strength of the several parts shall be taken into account.

2. When the effects of eccentricity of vertical loads, including loads produced by the deflection of floor and roof units, are likely to cause tensile stresses in the masonry, the masonry shall be designed in accordance with the requirements of s. Comm 53.323.

(b) *Allowable stresses.* 1. Compressive stresses. The compressive stresses in masonry shall not exceed the values given in Table 53-IX.

2. Bearing stresses. See s. Comm 53.34 (3) (b).

3. Composite masonry. In composite masonry with different kinds or grades of units or mortars, the maximum stress shall not exceed the allowable stress for the weakest combination of units and mortar of which the masonry is composed.

4. Stone flexural members. The maximum allowable flexural stress for natural stone shall be 1/6 of its modulus of rupture.

5. Bolts and anchors. See s. Comm 53.34 (5).

(2) THICKNESS AND HEIGHT. (a) *Height of masonry.* The height of a wall is defined for purposes of limitation as the maximum vertical distance between structural members completely supporting the weight of the wall or between the upper such support and the top of the wall, whichever is greater.

(b) *Thickness of load-bearing walls.* Except as prescribed in par. (bm), the minimum thickness of load-bearing masonry walls shall be at least 12 inches for the upper 36 feet of their height, and shall be increased 4 inches for the lower 36 feet or fraction thereof. Where a masonry load-bearing wall is made up of 2 or more wythes, the thickness of the wall shall not include any wythe less than 4 inches thick.

(bm) *Exceptions to thickness of load-bearing walls.* 1. Stiffened walls. Where single wythe or grouted multi-wythe masonry load-bearing walls composed of units of the same material are laterally supported at distances not greater than 12 feet apart by masonry crosswalls or by reinforced concrete floors, they may be of 12-inch thickness for the whole 72 feet.

2. Top-story walls. Top-story walls may be of 8-inch thickness provided that they are not over 12 feet in height and the roof construction imparts no lateral thrust to the walls.

3. One-story walls. In one-story buildings not exceeding 9 feet in height, the walls may be of 6-inch thickness provided that the roof span does not exceed 18 feet.

4. Penthouses and roof structures. Masonry walls above the main roof level, 12 feet or less in height, enclosing stairways, machinery rooms, shafts or penthouses may be of 8-inch thickness, and may be considered as neither increasing the height nor requiring any increase in the thickness of the masonry below.

5. Walls of apartment buildings. In buildings defined as places of abode not more than 3 stories in height, walls may be of 8-inch thickness when not over 36 feet in height and the roof imparts no horizontal thrust.

**TABLE 53-IX
ALLOWABLE COMPRESSIVE STRESSES IN UNIT MASONRY¹**

Type of Masonry	Type of Masonry Units	Average Ultimate Compressive Strength of Masonry Unit (psi)	Allowable Compressive Stresses on Gross Cross-Sectional Area (psi)			
			Type M Mortar and Grout	Type S Mortar and Grout	Type N Mortar and Grout	Type O Mortar and Grout
Single wythe and grouted multi-wythe masonry	Rubble stone	140	120	100	80
	Ashlar granite	800	720	640	500
	Ashlar limestone and marble	500	450	400	325
	Ashlar sandstone and cast stone	400	360	320	250
	Solid units except concrete block	10,000 and over	450	400	350	250
	8,000 to 10,000	400	350	300	200
	6,000 to 8,000	300	275	250	175
	4,000 to 6,000	250	225	200	150
	2,500 to 4,000	175	160	140	100
	Solid concrete block	1,800 and over	175	160	140	100
	Hollow load-bearing units	1,000 and over	90	80	75	60
Slushed or parged multi-wythe masonry	All allowable compressive stress values to 20% less than those for equivalent types of single-wythe and grouted multi-wythe masonry.					
Hollow multi-wythe masonry	Solid units except concrete block	2,500 and over	140	130	110	80
	Solid concrete block	1,800 and over	140	130	110	80
	Hollow load-bearing units	1,000 and over	70	60	55	40

1. Where a type of masonry unit, mortar or grout is no provided for in Table 53-IX, it will be the practice of the department to allow a maximum compressive stress in the masonry which is no more than 15% of the ultimate compressive strength of a masonry assemblage as determined by an approved test.

2. No individual masonry unit shall have a compressive strength less than 80% of the average ultimate compressive strength.

3. Stresses shall be calculated on actual dimensions rather than nominal dimensions, with consideration for reductions such as raked joints and cavities.

4. Type O mortar is permitted only in certain nonload-bearing masonry. See Table 53-VIII.

6. Walls below grade shall comply with the requirements of par. (e).

7. Metal tied hollow walls. Hollow walls shall not exceed 36 feet in height. The space (cavity) between wythes shall be not more than 4 inches. The backing wythe shall be at least as thick as the facing wythe. When both the facing and backing wythes have a thickness of 4 inches, the height of such hollow walls shall not exceed 24 feet.

8. Masonry bonded hollow walls. Not allowed.

Note: For definition of hollow walls, see s. Comm 53.321 (4) (c).

9. Rubble stone walls. All rubble stone walls shall be 4 inches thicker than required in par. (b), but in no case less than 16 inches in thickness. Other exceptions above do not apply to rubble stone walls.

10. Composite walls. Walls containing clay and concrete masonry units shall not exceed 48 feet in height.

(c) *Thickness of exterior nonload-bearing walls and parapets.* Nonload-bearing exterior masonry walls may be 4 inches less in thickness than required for load-bearing walls [including the exceptions under par. (bm)], but the thickness shall not be less than 8 inches except where 6-inch walls are specifically permitted.

(cm) *Exceptions to thickness of exterior nonload-bearing walls and parapets [s. Comm 53.322 (2) (c)].* 1. Panel walls. Panel walls shall be designed with sufficient strength and thickness and anchored to the structure so as to insure adequate support and resistance to wind or other lateral forces. Panel walls shall not be less than 2 inches in actual thickness and the maximum ratio of height to thickness shall not exceed 30.

2. Parapet walls. Parapet walls shall not exceed 3 times their thickness in clear height.

(d) *Thickness of interior nonload-bearing walls (partitions).* Nonload-bearing interior partitions shall be not less than 4

inches in thickness. Where partitions designed for lateral support at the top are not in tight contact with at least a 2-hour fire-resistant construction at the top, such partitions shall be not more than 24 times their thickness in clear height (see s. Comm 53.322 (3) (a) 3.).

(e) *Walls below grade.* Foundation walls shall be not less than 8 inches in thickness nor less than the thickness of the wall which they support. When subject to lateral pressure, foundation walls shall have lateral support at the top of the wall as specified in sub. (6). The height of wall and the depth below grade may not exceed the values specified in Table 53-IX A.

Note: The phrase "depth below grade" is intended to mean height of unbalanced fill.

1. For purposes of Table 53-IX A, "solid masonry" means solid units or hollow units with all cells grouted.

2. a. When the wall is laterally supported by vertical elements at intervals not more than 18 times the wall thickness, in addition to support at the top of the wall, the depth below grade may be one foot more than indicated in Table 53-IX A.

b. Pilasters providing lateral support shall have a width not less than 16 inches and shall project from the face of the wall not less than 1/12 the wall height. All cells of hollow units shall be filled with grout.

3. Where the height of wall or depth below grade exceeds the values indicated in Table 53-IX A, or if the wall is not laterally supported at the top, the foundation wall shall be designed in accordance with the provisions of s. Comm 53.323 for engineered masonry.

4. When a foundation wall contains an opening more than 4 feet in width or contains openings in more than 25% of its length, the design of the wall shall be based upon an engineering analysis.

TABLE 53-IX A

MAXIMUM HEIGHT OF WALL AND DEPTH BELOW GRADE FOR MASONRY FOUNDATION WALLS^{1,2}

Foundation Wall Construction Type of Unit and Nominal Thickness (Inches)		Maximum Wall Height ³ (Feet)	Maximum Depth Below Grade ⁴ (Feet)	
			Granular Backfill with Subsurface Drainage ⁵	Clay or Silt Backfill with Subsurface Drainage ⁵
Hollow Masonry	8	7	5	4-1/2
	10	8	6	5-1/2
	12	8	7	7
Solid Masonry	8	8	5-1/2	5
	10	8	6-1/2	6
	12	8	7	7

1. Where lateral support is provided by vertical elements, see s. Comm 53.322 (2) (e) 2.

2. The depth below grade and height of wall may exceed the values indicated if the design is based upon an engineering analysis.

3. Clear height between floors providing lateral support.

4. The depth below grade is determined by the height of finished grade above the basement floor or inside grade. Where exterior grade adjacent to the foundation wall is surcharged within a distance equal to the maximum depth permitted, the depth of wall shall be reduced accordingly.

5. Walls shall be provided with subsurface drainage.

(3) **LATERAL SUPPORT.** (a) *Requirements.* All masonry shall be laterally supported in conformance with the following:

1. Exterior walls. Exterior masonry walls, whether they be load-bearing or nonload-bearing, shall be laterally supported either horizontally or vertically at intervals not exceeding those indicated in Table 53-X.

2. Load-bearing interior walls. Load-bearing interior walls shall have lateral supports at either vertical or horizontal intervals not exceeding 24 times the wall thickness for solid masonry units and 20 times the wall thickness for hollow masonry units.

3. Nonload-bearing interior walls (partitions). Nonload-bearing partitions shall have lateral supports at either vertical or horizontal intervals not exceeding 30 times the thickness of the wall.

4. Special masonry walls. a. The height of an exterior free standing masonry wall having no lateral support at the top or at the ends may not exceed 4 times the thickness of the wall.

Note: See s. Comm 53.322 (2) (cm) 2. for parapet walls.

b. The height of a free standing interior wall may not exceed 9 times the thickness of the wall.

(b) *Methods of lateral support.* 1. General. Lateral support shall be provided by cross walls, pilasters or vertical structural members of sufficient strength to provide the required support when the limiting distance is measured horizontally; and/or by floors, roofs or horizontal structural elements which are of sufficient strength to provide the required support when the limiting distance is measured vertically. Provisions shall be made to transfer all lateral forces to the foundation.

2. Limitations. When horizontal structural elements are depended upon for lateral support, lateral support by vertical

elements shall also be provided at intervals of not more than 72 times the wall thickness.

**TABLE 53-X
MAXIMUM RATIO OF LATERALLY UNSUPPORTED HEIGHT OR LENGTH TO THICKNESS FOR ALL EXTERIOR WALLS**

Type of Masonry	Mortar Type			
	M	S	N	O
Single wythe walls of solid units or grouted walls of solid units	22	22	20	18
Slushed or parged walls of solid units	20	20	18	16
Hollow walls or walls [†] containing hollow units	18	18	16	12

[†]In computing the ratio for hollow walls, the value for thickness shall be the sum of the nominal thickness of the inner and outer wythes.

(c) *Pilasters.* A pilaster is a reinforced or nonreinforced masonry section which is thicker than and integrally bonded or mechanically keyed to the adjoining wall by alternate course bonding of masonry or by the use of pilaster blocks. A mechanically keyed control joint will be permitted on only one side of a pilaster which is used to provide lateral support. The projecting portion of the pilaster shall be bonded to the wall portion of the pilaster by lapping at least 50% of the units at the intersection or using special pilaster units.

1. All pilasters relied upon to provide lateral support shall not be less than 4 inches thicker than the wall supported nor less than 1/12 times the pilaster height. The width of pilasters shall be not less than 16 inches.

2. Where a pilaster is needed to carry a concentrated load from a flexural element, the least dimension shall be not less than 1/40 of the span of such an element and the height of the pilaster shall not exceed 12 times the least dimension of the pilaster. All voids, within and between masonry units, shall be fully grouted.

Note: The intent of this rule is to permit the empirical method of design for masonry pilasters carrying concentrated loads provided the pilaster details eliminate the eccentricity and provided the actual stresses are less than or equal to the allowable stresses. Pilasters may also be designed through engineering analysis in accordance with s. Comm 53.323.

(d) *Piers.* A pier is an isolated column of masonry. A load-bearing wall not bonded at the sides into associated masonry shall be considered a pier when its horizontal dimension measured at right angles to the thickness does not exceed 4 times its thickness.

1. All piers shall have lateral supports so that the vertical distance between such supports does not exceed 10 times their least dimension for single wythe or grouted masonry walls of solid masonry units, 8 times their least dimension for slushed or parged masonry walls of solid masonry units, and 6 times their least dimension for other masonry.

2. The least dimension of piers carrying flexural members shall be not less than 1/30 of the span of the flexural members.

3. Piers shall be laid in running bond unless reinforced as required for stack bond walls.

(4) **OPENINGS.** Unless evidence is provided to show that openings do not cause lateral stability and stress requirements to be exceeded, the amount of openings in a masonry wall shall not exceed the limits set forth in Table 53-XI.

(5) **BONDING.** (a) *General.* All types of masonry shall be adequately bonded.

**TABLE 53-XI
MAXIMUM RATIO OF LATERALLY UNSUPPORTED HEIGHT OR LENGTH TO THICKNESS FOR EXTERIOR WALLS WITH OPENINGS[†]**

Type of Masonry	Percent of Openings at any Horizontal Plane of Wall			
	20	40	60	Over 60
Single wythe walls of solid units or grouted walls of solid units	20	16	12	Submit design calculations
All other masonry	18	14	10	

[†]The percentage of openings shall be calculated for each 100 lineal feet of wall or portion thereof at any horizontal plane of wall. See Table 53-X for additional restrictions when type "N" or "O" mortar is used.

(b) *Longitudinal bond.* 1. Running bond. In each wythe of masonry, not less than 60% of the units in any transverse vertical plane shall lap the ends of units above and below a distance not less than 2 inches or 1/3 the height of the unit, whichever is greater. Masonry not lapped as required above will be considered as stack bond and shall be reinforced longitudinally as required in 2. below for masonry units laid in stack bond.

2. Stack bond. In each wythe of masonry with units laid in stack bond, the masonry shall be reinforced by a continuous tie assembly, as defined in s. Comm 53.316 (2), at vertical intervals not exceeding 16 inches. For interior nonload-bearing partitions this spacing may be increased to 24 inches. (For load-bearing walls, see also s. Comm 53.34 (3) (b) 4.)

3. Single wythe exterior concrete masonry walls. Where units are laid in running bond, such masonry wall shall be reinforced by a continuous tie assembly, as defined in s. Comm 53.316 (2), at vertical intervals not exceeding 24 inches. The requirement for tie assemblies is waived when the spacing of control joints is reduced to 80% of the values indicated in Table 53-XII, or if the spacing between control joints is 20 feet or less.

(c) *Transverse bond.* In multi-wythe masonry, adjacent wythes shall be bonded with either metal ties or headers in accordance with the following:

1. Bonding with metal ties. Adjacent wythes of masonry shall be bonded by embedment of reinforcement in the horizontal mortar joints with one of the following methods:

a. Continuous tie assemblies, as defined in s. Comm 53.316 (2), spaced at vertical intervals not exceeding 16 inches.

b. Individual ties, the equivalent of not less than 3/16 inch diameter steel rods, with one tie for not more than each 4 1/2 square feet of wall area. Ties in alternate courses shall be staggered. The maximum vertical distance shall not exceed 18 inches. The maximum horizontal distance shall not exceed 36 inches. Ties bent to rectangular shape shall be used with hollow masonry units. With solid masonry units, either rectangular ties or ties bent to 90° angles, Z shaped, to provide hooks not less than 2 inches long shall be used. In hollow walls, additional ties shall be provided at all openings, spaced not more than 3 feet apart around the perimeter and within 12 inches of the opening. Corrugated metal ties shall not be used.

2. Bonding with masonry bond units (headers). a. Adjacent wythes of masonry shall be bonded by the equivalent of a full header course overlapping both wythes at least 3 inches and spaced at intervals not greater than every seventh course. The clear distance between bond courses shall not exceed 16 inches for solid units and 24 inches for hollow units. One-seventh of the wall surface shall be header or bond units.

b. In ashlar masonry, bond stones uniformly distributed shall be provided to the extent of not less than 10% of the area of exposed faces.

c. Rubble stone masonry shall have not less than one bond stone for each 6 square feet of wall surface on both sides. Such walls, 24 inches or less in thickness, shall have bond stones with a maximum spacing of 3 feet vertically and 3 feet horizontally.

d. Hollow walls shall not be bonded with headers.

Note: For definition of hollow walls, see s. Comm 53.321 (4) (c).

3. Interrupted bond. Where a structural member interrupts a backing wythe such that transverse bond otherwise required cannot be achieved, the facing wythe shall be bonded to that structural member as in subd. 1.

(d) *Bond at intersections and corners.* Masonry that changes direction, or meets or intersects other masonry, where dependent for lateral support, shall be bonded by one of the following methods:

1. Walls laid separately. Provide joints with not less than the following:

a. For load-bearing elements, the equivalent of 1 $\frac{1}{4}$ inch by $\frac{1}{4}$ inch anchors with ends turned up not less than 2 inches and not less than 24 inches between turned ends, embedded equally into each adjacent wall and spaced not more than 2 feet vertically. Where there is not sufficient thickness of masonry to embed such anchors properly, equivalent anchorage shall be provided by cross-pins or other means.

b. For nonload-bearing elements, the equivalent of $\frac{7}{8}$ inch by 22 U.S. gage anchors, 8 inches or more in length, embedded equally into each adjacent wall and spaced not more than 16 inches vertically.

c. When regularly toothed or blocked, the vertical spacing of anchors required above may be doubled.

2. Walls laid simultaneously. Provide joints satisfying one of the following:

a. Lap at least 50% of the units at the intersection.

b. Use details which are designed to permit differential movement at the intersection of interior and exterior masonry, provided such details are consistent with the requirements for lateral stability of the masonry.

(6) ANCHORAGE. (a) *General.* All masonry dependent upon structural elements for continuity or lateral support except as specified in s. Comm 53.63 (3) shall be securely anchored thereto in such a manner as to resist all forces, especially wind and all lateral forces acting either inward or outward.

(b) *Load-bearing masonry.* 1. Floor anchorage. a. All types of concrete floor systems which bear continuously on masonry with concrete to masonry contact may be considered to provide adequate lateral support.

b. All other structural elements intended to provide lateral support shall be securely anchored to the masonry.

2. Roof anchorage. Roof structures shall be securely anchored to load-bearing masonry with the equivalent of at least $\frac{1}{2}$ -inch diameter bolts spaced not more than 6 feet on center and embedded in the masonry according to one of the following methods:

a. A steel plate having a minimum surface area of 6 square inches securely attached to the head of each bolt and completely embedded in the masonry at least 12 inches.

b. A continuous bond beam the equivalent of not less than 8-inch lintel (bond beam) blocks with 2 continuous No. 4 bars embedded in 2,500 psi concrete fill provided at the top of the masonry. The bolts shall be embedded at least 6 inches and hook beneath the longitudinal reinforcement.

(c) *Exterior nonload-bearing masonry.* 1. Anchorage of masonry to the structural framework. Where masonry is dependent upon the structural framework for lateral support or transmission of lateral loads, the masonry shall be anchored to the framework on at least 2 opposite sides of the perimeter of the wall, with the equivalent of a one-inch wide by $\frac{1}{8}$ -inch thick anchor for each 18 square feet of wall surface, embedded at least 8 inches into the masonry, and spaced not more than 36 inches on center. Wedging will not be considered as an equivalent method.

2. Anchorage of panel walls suspended from the structural framework. Exterior prefabricated masonry assemblages and other elements, larger than conventional size masonry units shall be anchored to their weight supports with the equivalent of $\frac{5}{8}$ inch minimum diameter stainless steel bolts or $\frac{3}{4}$ inch minimum diameter corrosion resistant plated steel bolts.

(d) *Interior nonload-bearing masonry.* Where masonry is dependent upon the structural framework for lateral support, such masonry shall be anchored with the equivalent of a flexible $\frac{3}{16}$ inch diameter anchor for each 12 square feet of wall surface, embedded at least 4 inches into the masonry, and spaced not more than 48 inches on center. Wedging may be used to anchor the top of a masonry partition to its top horizontal support.

(7) JOINTING. Joints commensurate with lateral stability requirements shall be installed in all exterior masonry to allow for expected growth of clay products and shrinkage of concrete products.

(a) *Vertical jointing.* Vertical control joints shall be provided at a spacing in compliance with Table 53-XII.

Note: To accomplish the intended purpose, joints should be located at critical locations such as (but not limited to) changes in building heights, changes in framing systems, columns built into exterior walls, major wall openings and changes in materials.

(b) *Horizontal jointing.* Where supports such as shelf angles or plates are required to carry the weight of masonry above the foundation level [see ss. Comm 53.322 (2) (a) and 53.36 (4) (b)], a pressure-relieving joint shall be provided between the structural support and any masonry which occurs below this level. The joint width shall be such as to prevent any load being transmitted from the support to any element directly below. All mortar and rigid materials shall be kept out of this joint. This type of joint shall be provided at all such supports in a concrete frame structure where clay masonry is exposed to the weather.

TABLE 53-XII
MAXIMUM SPACING OF EXTERIOR MASONRY CONTROL JOINTS
BETWEEN UNRESTRAINED ENDS[†] (FEET)

Loading Conditions	Type of Material	Openings (Percentage of total wall area)			
		0 to 20		More than 20	
		Joint to Joint	Joint to Corner	Joint to Joint	Joint to Corner
Load-bearing	Clay units	140	70	100	50
	Concrete units	60	30	40	20
Nonload-bearing walls . . .	Clay units	100	50	60	40
	Concrete units	50	25	30	20

[†]Jointing required is a minimum and is not intended to prevent minor cracking. The distances given for maximum spacing of joints are for a single wall plane. For composite walls, the maximum spacing of joints shall be governed by the masonry material type used in the exterior wythe.

History: Cr. Register, July, 1974, No. 223, eff. 1-1-75; am. (5) (b) 3. and (6) (c) 1., Register, December, 1974, No. 228, eff. 1-1-75; am. (3) (c) 2. and (5) (b) 3., Register, December, 1976, No. 252, eff. 1-1-77; am. (5)(c) 1.b., Register, January, 1980, No. 289, eff. 2-1-80; am. (6) (a), Register, December, 1981, No. 312, eff. 1-1-82; r. and recr. (2) (bm) 6. and (3) (a) 4., cr. (2) (e), Register, December, 1983, No. 336, eff. 1-1-84; am. (2) (b), Register, March, 1991, No. 423, eff. 4-1-91.

Comm 53.323 Engineered masonry. (1) DEFINITION. Engineered masonry means design of plain or reinforced masonry based on an engineering analysis.

(2) REQUIREMENTS. Calculations or other substantiating data to justify a reduction in requirements shall be submitted for all items in conflict with s. Comm 53.322, 53.33 or 53.34.

Note: It will be the practice of the department to approve designs in conformance with the following: (1) clay and shale units—"Building Code Requirements for Engineered Brick Masonry", Structural Clay Products Institute (now known as Brick Institute of America), 1750 Old Meadow Road, McLean, Virginia 22101 (August 1969); (2) concrete units—"Specifications for the Design and Construction of Load-Bearing Concrete Masonry", National Concrete Masonry Association, P.O. Box 9185, Rosslyn Station, Arlington, Virginia 22209 (1970); (3) cast stone and architectural precast concrete units—"Design of Precast Concrete Wall Panels", Title No. 68-46, *ACI Journal*, July 1971 (also see s. Comm 53.40); (4) "Building Code Requirements for Masonry Structures", ACI 530/ASCE 5; (5) "Specifications for Masonry Structures", ACI 530.1/ASCE 6; and 6 standards of accepted engineering practice, provided proposed materials are in successful similar use or proven by test to be adequate.

(3) LIMITATIONS. Where design by engineering analysis is based upon material of a higher grade or a superior workmanship than is generally provided in accepted practice, it must be clearly established to the satisfaction of the department by test or other evidence that such quality exists and will only be employed under special inspection or field testing.

History: Cr. Register, July, 1974, No. 223, eff. 1-1-75.

Comm 53.33 Construction. (1) COLD WEATHER WORK. Adequate cold weather construction and protection provisions shall be taken to prevent masonry from being damaged by freezing.

Note: It will be the practice of the department to accept conformance with "Recommended Practices for Cold Weather Masonry Construction," International Masonry Industry All-Weather Council, 1970. (Available from International Masonry Institute, 823 15th Street NW, Washington, D.C. 20005.)

(2) LOAD-BEARING MASONRY. (a) The maximum thickness of a mortar joint shall be $\frac{1}{2}$ inch.

(b) Except for head joints used for weep holes and ventilation, solid masonry units shall be laid so as to achieve full head and bed joints.

(c) Hollow masonry units shall be laid with full head joints and full bed joints under the full bearing areas of the face shells (and under webs where the adjacent cells are to be filled with grout).

(3) CLEANING. Chemical cleaning agents shall be prevented from harming the metal reinforcement of structural components.

History: Cr. Register, July, 1974, No. 223, eff. 1-1-75; r. (1) and renum., Register, December, 1974, No. 228, eff. 1-1-75.

Comm 53.34 Miscellaneous design-construction details. (1) SPECIAL USE WALLS. (a) Hollow walls. 1. In exte-

rior hollow walls, suitable flashing shall be installed at the bottom of the cavity so as to drain any water outward.

2. Open vertical joints or weep holes of $\frac{3}{8}$ inch minimum diameter shall be provided in the facing just above the flashing at a horizontal spacing not exceeding 3 feet.

(b) Retaining walls. The tops of exposed retaining walls shall be coped with noncombustible weatherproof material.

(c) Reuse of existing walls. Existing masonry may be used in the alteration or extension of a structure, provided that under the new conditions imposed it meets the requirements of this code or is made so by reasonable repairs.

Note: See s. Comm 51.02 (12) for requirements of parapet walls.

Note: See s. Comm 53.11 (4) (e) 2. for requirements for scuppers or relief openings.

(2) CHANGES IN THICKNESS OR PLANE. (a) Nonvertical planes. Details and techniques for all masonry to be installed in a nonvertical plane shall be submitted to the department for approval.

(b) Thickness change requirements. Where hollow walls or walls of hollow masonry units change in thickness, a course of solid masonry, concrete-filled hollow units or a continuous bearing element shall be interposed between the thicker and thinner sections.

(c) Increase in thickness, including corbels. The thickness of masonry shall not be increased (in the upward direction), except for corbels as follows:

1. The maximum horizontal projection of a corbel from the face of the wall from which it projects shall not exceed $\frac{1}{3}$ the thickness of the wall.

2. The maximum projection of a masonry unit shall not exceed $\frac{1}{2}$ the height of the unit nor $\frac{1}{3}$ its bed depth.

(d) Variation in thickness (chases and recesses). Walls shall not be less than their required thickness between horizontal lateral supports except where permitted for chases and recesses as follows:

1. Chases or recesses shall not be made in load-bearing walls 8 inches or less in thickness. Pipes, ducts, conduits or similar noncombustible items may be installed in cores of hollow units.

2. Chases or recesses shall not be closer than 2 feet to any pilaster, buttress, cross wall, end wall or other stiffener that provides lateral support.

3. The maximum depth of any chase or recess shall not exceed $\frac{1}{3}$ the thickness of the wall.

4. The length along the wall of any chase or recess shall not exceed 4 feet.

5. The clear distance between chases and recesses or each other shall not be less than 4 times the wall thickness.

6. Any chase or recess in conflict with the previous requirements shall be considered as an opening (see s. Comm 53.34 (3) (a) 4.).

7. No chase or recess shall reduce the thickness of material below the minimum required for fire walls, fire division, fire partitions or fire protective covering of structural members.

(e) *Protection.* In masonry exposed to the weather, pockets or crevices in which water may accumulate shall be avoided or protected to prevent damage.

(3) **BEARING.** (a) *Weight support of masonry.* 1. General requirements. The bearing support for all masonry shall be of noncombustible material and have lateral stability.

2. Projections. The projection of a wall beyond the edge of a supporting member other than masonry, such as a shelf angle or edge of a beam, shall not exceed 1 $\frac{1}{4}$ inches, unless at least $\frac{2}{3}$ the mass of the wythe of masonry involved is located directly over the load-carrying member.

3. Shelf angles. See s. Comm 53.322 (7) (b).

4. Openings. The masonry above openings shall be adequately supported. The bearing length of structural elements which support the masonry above the opening shall be not less than 4 inches. The bearing stresses at these locations shall not exceed those allowed in s. Comm 53.322 (1).

(b) *Bearing on masonry.* Bearing stresses in masonry shall not exceed those specified in Table 53-IX. Flexural members shall have bearing details that allow rotation at their supports without causing local failures.

1. Concentrated load. Beams, girders, trusses, joists and other members causing concentrated loads shall bear a minimum of 3 inches in length in the direction of span upon at least one of the following:

a. The equivalent of a nominally reinforced 2,500 psi concrete beam 8 inches in height.

b. At least 8 inches in height of masonry composed of solid masonry units with all voids and joints completely filled with mortar.

c. A metal plate of sufficient thickness and size to safely distribute the load to masonry units. For piers and columns, the bearing plate shall not exceed 60% of the cross-sectional area of the pier or column and the resultant reaction of all vertical and horizontal loads shall fall within the middle third of the member.

d. The bond beam shall be the equivalent of not less than 8-inch lintel (bond beam) blocks with 2 No. 4 bars embedded in 2,500 psi concrete fill. The loads shall bear on the concrete fill.

2. Continuous loads. Joists, trusses and beams other than wood [for wood, see s. Comm 53.63 (4)], spaced 4 feet or less on center and 40 feet in span, slabs or other members causing continuous loads shall be transmitted to masonry with a minimum bearing length of 3 inches upon solid masonry at least 2 $\frac{1}{2}$ inches in height, or as indicated for concentrated loads.

3. Multi-wythe walls. Ties required for transverse bond shall be installed in the first horizontal mortar joint below the required beam, solid masonry or metal plate.

4. Stack bond walls. Concentrated loads shall be distributed into masonry laid in stack bond by a concrete beam or bond beam (as defined in subd. 1.). For masonry of solid units, 2 additional rows of a continuous tie assembly [as defined in s. Comm 53.316 (2)] may be used instead of a concrete beam or bond beam.

5. Support of wood floor members. a. Where a wood structural member is buried in masonry for support, it shall be firecut or a self-releasing device shall be used.

b. Where the end of a wood structural member is built into an exterior wall, a $\frac{1}{2}$ -inch air space shall be provided at the sides, top and end of such member.

(4) **JOINTING.** See s. Comm 53.322 (7) for jointing.

(5) **BOLTS AND ANCHORS.** The allowable shear on steel bolts and anchors shall not exceed the values given in Table 53-XIII.

TABLE 53-XIII
ALLOWABLE SHEAR ON BOLTS AND ANCHORS

Bolt or Anchor Diameter (Inches)	Embedment† (inches)	Allowable Shear (Pounds)
$\frac{1}{4}$	4	270
$\frac{3}{8}$	4	410
$\frac{1}{2}$	4	550
$\frac{5}{8}$	4	750
$\frac{3}{4}$	5	1100
$\frac{7}{8}$	6	1500
1	7	1850
1- $\frac{1}{8}$	8	2250

†Bolts and anchors shall be solidly embedded in mortar or grout.

History: Cr. Register, July, 1974, No. 223, eff. 1-1-75; am. (1) (d), Register, December, 1974, No. 228, eff. 1-1-75; am. (3) (b) (intro.) and 1 b, Register, December, 1977, No. 264, eff. 1-1-78; am. (1), Register, December, 1981, No. 312, eff. 1-1-82.

Comm 53.35 Tests. (1) **GENERAL.** All masonry materials shall meet the requirements of s. Comm 53.31, and the department may require submittal of test data, at any time, to show conformity.

(2) **SAMPLING AND TESTING.** The selection and construction of all test specimens shall conform to standard test procedures and shall be truly representative of the materials, workmanship and details to be normally applied in practice.

(3) **STANDARDS.** The testing of all masonry shall be in accordance with Table 53-XIV.

(4) **SPECIAL TESTS.** (a) *Fire tests.* See s. Comm 51.04.

(b) *Load tests.* Whenever there is reasonable doubt as to the stability or structural safety of a completed structure or part thereof, the department may require a load test on the building or portion of the structure in question.

**TABLE 53-XIV
STANDARD METHODS OF SAMPLING AND TESTING**

Classification	Item	ASTM Test Method Standard
Base Materials	Portland Cement	C 150
	Masonry Cement	C 91
	Hydrated Lime	C 25, C 50, C 110
	Gypsum	C 471, C 472
Mortar	Aggregate	C 144
	Mortar	C 270 ^a
Masonry Units	Clay and Shale	C 67, C 112
	Concrete	C 140
	Natural Stone	C 97, C 99, C 170, C 666
	Cast Stone	C 42, C 97
	Arch. Precast Concrete	C 39, C 42, C 97, C 457
	Gypsum	C 473
Assemblies		E 72, E 149, E 447

^aMortar in the field, tested in a laboratory, shall test at least 85% of the minimum compressive strength required, and the field mortar will serve as the final basis for mortar approval. When mortar is not proportioned according to limitations of Table 53-VII, mortar shall be periodically tested by an impartial testing laboratory. Results of such required testing shall be submitted as evidence of conformity, when requested by the department.

History: Cr. Register, July, 1974, No. 223, eff. 1-1-75; r. and recr. table, Register, March, 1991, No. 423, eff. 4-1-91.

Comm 53.36 Veneer, furring and trim. (1) GENERAL. Veneer, furring and trim as used in this section refers to a facing of weather-resistant noncombustible materials securely attached to a backing, but not so bonded as to exert common action under load.

(a) Veneer shall not be considered as part of the masonry when computing strength or required thickness.

(b) Veneer shall not be assumed as supporting any load other than its own weight.

(2) MATERIAL REQUIREMENTS. (a) *General.* See s. Comm 53.31 for typical requirements of common masonry materials.

(b) *Tile and terra-cotta.* Such units shall be frost-proof and not more than 288 square inches in area.

(3) THICKNESS. No materials used for veneer shall have a thickness less than the values listed in Table 53-XV.

(4) BEARING AND BACKING SUPPORTS. (a) Bearing and backing supports shall be weather-resistant and shall provide sufficient strength and stability to adequately support the veneer.

(b) Masonry veneer 1⁵/₈ inches or greater in thickness shall be supported by shelf angles or other equivalent weight supports. The spacing between such supports shall not exceed 18 feet vertically when the veneer is more than 30 feet above grade.

(5) ATTACHMENT. (a) *General.* All veneers, supports and attachments shall be capable of resisting a horizontal force equal to the wind loads specified in s. Comm 53.12. Attachment shall be accomplished by mechanical methods or adhesion.

(b) *Attachment by mechanical methods.* All anchors shall be corrosion-resistant.

1. Veneer of conventional size masonry units (one square foot or less). Such veneer shall be securely attached to its backing by anchors the equivalent of 22 U.S. gage corrugated sheet steel ⁷/₈ inch wide with at least one such tie located in every 2 square feet of wall.

2. Veneer of large size masonry units (greater than one square foot). Such veneer shall be securely attached with anchors the equivalent of not less than ¹/₄ inch diameter bolts in accordance with either of the following:

a. Each unit individually anchored to the supporting framework with at least 3 anchors.

b. Individual units doweled to each other at all horizontal joints and anchored to the backing at all horizontal and vertical joints so that one anchor is provided for every 6 square feet of wall surface.

3. Veneer of metal. Exterior metal veneer shall be securely attached to its backing or supporting framework with the equivalent of wire of at least No. 9 steel wire gage spaced not more than 24 inches apart both horizontally and vertically. Wider spacing where proved adequate may be used when units exceed 4 square feet in area, provided there are at least 4 proper attachments per unit.

(c) *Attachment by adhesion.* Veneer one inch or less in thickness may be cemented to a masonry or concrete wall or to exterior portland cement plaster on high rib galvanized metal lath with an adhesive, provided that the bond is sufficient to withstand a shearing stress of 50 psi after curing for 28 days. Individual units so attached shall not exceed 30 inches in any one dimension nor have more than 540 square inches of face area.

**TABLE 53-XV
MINIMUM THICKNESS OF VENEERS**

Material	Minimum Actual Thickness (Inches)
Clay Brick or Tile	1- ⁵ / ₈
Concrete Masonry Units	1- ⁵ / ₈
Natural Stone	1- ⁵ / ₈
Cast Stone	1- ¹ / ₂
Architectural Precast Concrete	⁵ / ₈
Marble Slabs	⁷ / ₈
Slate	⁷ / ₈
Architectural Terra-cotta	1
Ceramic Veneer—Mechanical Anchorage	1
Ceramic Veneer—Adhesion Anchorage	³ / ₁₆
Asbestos Cement Boards	¹ / ₈
Aluminum Clapboard Siding024
Metal—Corrosion Resistant0149
Stucco and Exterior Plaster	³ / ₄

(6) JOINTING. Pressure-relieving joints commensurate with lateral stability requirements shall be provided both horizontally and vertically where needed to compensate for differential movement between veneer and backing or frame. See also s. Comm 53.322 (7).

(7) GROUNDING. Metal veneers fastened to supporting elements which are not a part of the grounded metal framing of a building shall be effectively grounded.

History: Cr. Register, July, 1974, No. 223, eff. 1-1-75.

Subchapter IV—Concrete

Comm 53.40 Concrete requirements. The design and construction of structures in concrete of cast-in-place or precast construction shall conform to ACI 318 or ACI 318.1.

History: Cr. Register, July, 1974, No. 223, eff. 1-1-75; am. Register, December, 1981, No. 312, eff. 1-1-82; r. and recr. Register, March, 1991, No. 423, eff. 4-1-91; am. Register, January, 1994, No. 457, eff. 2-1-94.

Comm 53.41 Gypsum concrete requirements.

(1) **GENERAL.** The design and construction of gypsum concrete shall be in accordance with ASTM C-317 or C-956.

(2) **LIMITATIONS.** Gypsum concrete shall not be used where exposed directly to weather or where subject to wetting. Gypsum concrete shall be protected from freezing or coming in contact with moisture during shipment, storage, erection or pouring.

History: Cr. Register, July, 1974, No. 223, eff. 1-1-75; r. and recr. (1), Register, March, 1991, No. 423, eff. 4-1-91.

Subchapter V—Metals

Comm 53.50 Structural steel requirements. The design, fabrication and erection of structural steel for buildings and structures shall conform to: AISC, "Specification for Design, Fabrication and Erection of Structural Steel for Buildings," and the provisions of the accompanying commentary for this specification, with the following modifications:

(1) **FABRICATOR SPLICES.** Any shop or field connection or splice not specifically shown on the designer's drawings shall have been previously approved by the designer and a record shall be kept of this approval. This record shall be submitted to the department when requested.

(2) **LATERAL BRACING MEMBERS.** (a) Individual bracing members providing lateral restraint to columns or to compression flanges of beams and girders or to compression chords of trusses shall be proportioned to resist at least 2% of the compression force in the element braced unless a suitable analysis is made to determine the appropriate strength and stiffness of the bracing member.

(b) An analysis shall be conducted when bracing forces larger than 2% of the compression force are encountered in lateral bracing members, such as angles, channels and zee sections.

Note: These bracing forces may be encountered as a result of the lack of symmetry of the lateral bracing members.

(3) **CERTIFICATION AND IDENTIFICATION.** (a) *Certification.* All structural steel shall have a mill report or a test report made in accordance with ASTM A-6 from the steel supplier; the reports shall include the information on the minimum yield strength and chemistry of the steel furnished. Upon request by the department, the supplier or fabricator shall furnish certified mill reports, test reports, affidavits and/or other information about the steel for the specific project.

(b) *Marking of steel.* Steel used for main components in completed members or assemblies shall be marked. This marking shall be accomplished by color coding or other means of identification as to its type or grade prior to shipment from the mill. The marking shall be continued through the fabricator's plant to the construction site. Steel which conforms to ASTM A-36 designation may be fabricated without marking.

Note: The type and grading may be indicated by the ASTM specification designation or a designation correlated to the information included on the certified mill or test report.

(c) *Acceptable steel types.* Steel of structural quality shall conform to the standards specified in section 1.4.1.1 of the AISC "Specification for the Design, Fabrication and erection of Structural Steel for Buildings" Steel types not listed in the above mentioned section of the AISC may be used if approved by the designer. An approval letter indicating conformance with pars. (a) and (b) shall be sent to the department.

History: Cr. Register, July, 1974, No. 223, eff. 1-1-75; am. (2), Register, December, 1983, No. 336, eff. 1-1-84; am. (intro.) and (3), Register, March, 1991, No. 423, eff. 4-1-91.

Comm 53.51 Cold formed steel requirements. The design of cold-formed steel for buildings and structures shall conform to the AISI "Specification for the Design of Cold-Formed Steel Structural Members," and the provisions of the accompanying commentary for this specification, with the following modifications:

(1) **FABRICATOR SPLICES.** See s. Comm 53.50 (1).

(2) **LATERAL BRACING MEMBERS.** See s. Comm 53.50 (2).

(3) **CERTIFICATION.** See s. Comm 53.50 (3) (a).

History: Cr. Register, July, 1974, No. 223, eff. 1-1-75; am. (intro.) Register, March, 1991, No. 423, eff. 4-1-91.

Comm 53.52 Steel joist requirements. The design, fabrication and erection of steel joists shall conform to the "Standard Specifications, Load Tables, and Weight Tables for Steel Joists and Joist Girders" adopted by the SJI.

History: Cr. Register, July, 1974, No. 223, eff. 1-1-75; am. Register, January, 1980, No. 289, eff. 2-1-80; am. Register, March, 1991, No. 423, eff. 4-1-91.

Comm 53.53 Structural welding of steel. The requirements of this section shall apply to all welds on or between materials within the scope of ss. Comm 53.50, 53.51 and 53.52.

(1) **BASE METALS.** Steels to be welded under this code are listed in AWS D 1.1, sections 8.2 and 10.2 or AWS D 1.3., section 1.2.1.

(2) **FILLER METALS.** Filler metal requirements that are acceptable under this code are listed in AWS D 1.1 section 4.1 or AWS D 1.3., section 5.

(3) **WELDING PROCESSES.** (a) Manual shielded metal arc, submerged arc, gas metal arc and flux cored arc welding processes conforming with the procedures established in AWS D 1.1, sections 2, 3 or 4 shall be considered as prequalified and are approved for use without performing procedure qualification tests.

(b) Electroslag and electrogas welding processes will not be considered as prequalified. They may be used provided a procedure is developed and provided it conforms to the applicable provisions of AWS D 1.1, sections 2, 3 or 4.

(4) **WELDING PROCEDURES.** (a) *Procedure specification.* All welding procedures shall be prepared as a written procedure specification. This written procedure specification shall be prepared by the manufacturer, fabricator or contractor and shall be made available to the department or its designated testing agent prior to commencing a weld test.

(b) *Procedure qualification.* All joint welding procedures shall be previously qualified by tests as prescribed in AWS D 1.1 section 5.6, except for the prequalified procedures exempted in sub. (3) (a). The test shall be conducted by the department or its designated testing agent. The test results of a test conducted by a designated testing agent shall be submitted by the agent to the department for approval.

(5) **DESIGN OF WELDED CONNECTIONS AND JOINTS.** The details of all joints shall comply with the requirements of AWS D 1.1, section 2 and section 10, parts C and D or AWS D 1.3., section 3. All joint forms, except those specified in AWS D 1.1, section 2 and section 10, parts C and D, shall not be used unless qualified to the satisfaction of the department.

(a) *Stud welding.* Stud welding shall be done by a procedure qualified in accordance with the requirements of AWS D 1.1, section 4, part F.

(6) **OPERATOR QUALIFICATIONS.** Except as provided in (b), all structural welding work shall be performed by persons registered by the department.

Note: The rules pertaining to the registration of structural welders are specified in s. Comm 5.34.

(b) A person who holds a valid credential as a certified welder that was issued by the department prior to the effective date of these rules may continue to perform structural welding until the expiration of his or her current certification.

(8) **WELD IDENTIFICATION.** Each structurally significant member shall have its welding identified by a distinguishing mark stamped on the member by the registered welder or welders involved.

(9) **CRITERION OF FINAL ACCEPTANCE.** All structural welding is subject to examination by approved inspectors and such

inspection shall be the final criterion for conformance and acceptability for the intended use.

History: Cr. Register, July, 1974, No. 223, eff. 1-1-75; am. (10), Register, December, 1977, No. 264, eff. 1-1-78; am (5) and (6) (a), (b) and (c), Register, January, 1980, No. 289, eff. 2-1-80; cr. (7) (c), Register, January, 1985, No. 349, eff. 2-1-85; am. (1) to (6) Register, March, 1991, No. 423, eff. 4-1-91; am. (7) (b), Register, January, 1994, No. 457, eff. 2-1-94; correction in (7) (intro.) made under s. 13.93 (2m) (b) 5., Stats, Register, January, 1994, No. 457; r. and recr. (6), r. (7), (10), am. (8), Register, October, 1996, No. 490, eff. 11-1-96.

Comm 53.54 Aluminum framing requirements.

The design, fabrication and erection of aluminum structural framing members shall conform to "Specifications for Aluminum Structures", published by The Aluminum Association.

History: Cr. Register, July, 1974, No. 223, eff. 1-1-75; am. Register, March, 1991, No. 423, eff. 4-1-91.

Comm 53.55 Stainless steel requirements.

The design, fabrication and erection of light gage stainless steel framing members shall conform to AISI, "Stainless Steel Cold-Formed Structural Design Manual."

History: Cr. Register, July, 1974, No. 223, eff. 1-1-75; am. Register, January, 1980, No. 289, eff. 2-1-80; am. Register, March, 1991, No. 423, eff. 4-1-91.

Comm 53.56 Steel cable requirements.

The design, fabrication and erection of steel cables for buildings shall conform to AISI "Manual for Structural Applications of Steel Cables for Buildings."

History: Cr. Register, January, 1980, No. 289, eff. 2-1-80; am. Register, March, 1991, No. 423, eff. 4-1-91.

Subchapter VI—Wood and Wood Fiber Products

Comm 53.60 General. (1) SCOPE. The requirements of ss. Comm 53.60 to 53.63, inclusive, shall apply to the materials, design, and construction procedures used in all wood and wood fiber products construction work under this code.

(2) DEFINITION. Wood and wood fiber products include those structural elements derived from solid wood, structural glued-laminated timber, plywood, fiberboard, hardboard and other wood-fiber-based materials.

History: Cr. Register, July 1974, No. 223, eff. 1-1-75.

Comm 53.61 Materials and design of structural elements. (1) SAWN LUMBER. The material characteristics and the design provisions of load-bearing structural sawn lumber shall be in accordance with the following adopted standard and listed exceptions:

(a) "National Design Specification for Wood Construction" and its supplement.

1. Exceptions: a. Section 4.1.7. The provisions of this section shall also apply to reused lumber. Reused lumber shall be considered to have a duration of load factor of 0.90.

b. Section 4.2.2. In addition to requiring grading in conformance with ASTM D 245, lumber (including reused lumber) of species and grades not listed in the supplement to the NDS shall be identified by the grade mark of, or certificate of inspection issued by, a lumber grading or inspection bureau or agency recognized as being competent.

c. Section 2.2.5.3. The cumulative effects of short-time loads, such as wind, shall be considered in determining duration

of load. For wind load, a duration of load factor no greater than 1.6 may be used.

(2) STRUCTURAL GLUED-LAMINATED TIMBER. Structural glued-laminated timber is an engineered, stress-rated product of a timber laminating plant comprising assemblies of specially selected and prepared wood laminations securely bonded together with adhesives. The grain of all laminations is approximately parallel longitudinally. The following standards are adopted as part of this building code for the design and production of structural glued-laminated timber, except that the modification of design stresses for duration of load shall be as specified in sub. (1) (a) 1.c.

(a) AITC 117, "Standard Specifications for Structural Glued-Laminated Timber of Softwood Species."

(b) AITC 119, "Standard Specifications for Hardwood Glued-Laminated Timber."

(3) ROUND POLES. Allowable unit stresses for nongraded round poles used as structural members other than piling shall be 80% of the allowable unit stresses for select structural grade beams and stringers (19% moisture content) of the appropriate species as listed in the supplement to the National Design Specification for Wood Construction. No obviously unsound load-bearing poles are to be used. Higher allowable stresses will be permitted for round poles graded in accordance with a recognized standard.

Note: ASTM designation D 3200-73 "Standard Specification and Methods for Establishing Recommended Design Stresses for Round Timber Construction Poles" is acceptable for graded round poles. ANSI Standard 05.1 may be used for poles subject to transverse loads only.

(4) PILING. See s. Comm 53.24.

(5) PLYWOOD. (a) The quality and design of all plywood used in construction of all buildings and structures shall conform to the minimum standards under this section. All plywood when used structurally, including among others, use for siding, roof and wall sheathing, subflooring, diaphragms, and built-up members, shall conform to the performance standards for its type in U.S. Product Standard PS 1 for softwood plywood/construction and industrial. Each panel or member shall be identified for grade and glue type by the trademarks of an approved testing and grading agency. In addition, all plywood when permanently exposed in outdoor applications shall be of exterior type.

Note: It will be the policy of the department to approve designs in conformance with the following: (1) "Plywood Design Specification" including Supplement No. 1 "Design of Plywood Curved Panels"; Supplement No. 2 "Design of Plywood Beams"; Supplement No. 3, "Design of Flat Plywood Stressed-Skin Panels"; and Supplement No. 4 "Design of Flat Plywood Sandwich Panels"; (2) "Plywood Diaphragm Construction"; (3) Laboratory Report 121, "Plywood Folded Plate Design and Details"; (4) Laboratory Report 93, "Load-Bearing Plywood Sandwich Panels"; and (5) "Fabrication Specifications Plywood-Lumber Components: CP-8, BB-8, SS-8, SP-61, FF-62, PW-61" (above publications available from the American Plywood Association, 1119 A Street, Tacoma, Washington 98401); (6) Design Guide HP-SG-71, "Structural Design Guide for Hardwood Plywood" (available from the Hardwood Plywood Manufacturers Association, 2310 South Walter Reed Drive, Arlington, Virginia 22206).

(b) No part of any of the above referenced standards shall supersede the general live load requirements of s. Comm 53.11.

(7) SOLID WOOD FLOOR AND ROOF SHEATHING. Minimum thickness of nonstress rated lumber used for floor and roof sheathing shall be in accordance with Table 53-XVI.

(a) The above dimensions shall be the minimum dimensions for lumber with grades as specified in Table 53-XVII.

TABLE 53-XVI
MINIMUM NET THICKNESS OF LUMBER PLACED (INCHES)

Use	Span (Inches)	Perpendicular to Support		Diagonal to Support	
		Surfaced Dry†	Surfaced Unseasoned	Surfaced Dry	Surfaced Unseasoned
Floors	24	3/4	25/32	3/4	25/32
	16	5/8	11/16	5/8	11/16
Roofs	24	5/8	11/16	3/4	25/32

†Maximum 19% moisture content.

TABLE 53-XVII
MINIMUM BOARD GRADES†

Grading Agency	Solid Floor or Roof Sheathing	Spaced Roof Sheathing
West Coast Lumber Inspection Bureau	Utility	Standard
Western Wood Products Association	4 Common or Utility	3 Common or Standard
Southern Pine Inspection Bureau	No. 3	No. 2
Redwood Inspection Service	Merchantable	Construction, common
National Lumber Grades Authority	4 Common or Utility	3 Common or Standard
Northern Hardwood and Pine Manufacturers Association	4 Common	3 Common
Northeastern Lumber Manufacturers Association	4 Common	3 Common

†The above grades are taken from grading rules approved by the American Lumber Standards Committee.

(8) **TIMBER FASTENERS.** The design and use of timber fasteners shall be in accordance with the requirements of National Design Specification for Wood Construction.

(a) *Fastener identification.* Light gauge perforated metal plate connectors shall be permanently identifiable with regard to their gauge and manufacturer.

(9) **WOOD FOUNDATIONS AND WALLS BELOW GRADE.** (a) *Design.* 1. The design of wood foundations and walls below grade shall be in accordance with the following adopted standard and subd. 2: "All-Weather Wood Foundation System, Basic Requirements," Technical Report No. 7.

2. Exceptions: a. Section 3.3.1. Fasteners for use in preservative treated wood shall meet the requirements of this article. Fasteners of silicon bronze or copper or stainless steel types 304 or 316, as defined by the American Iron and Steel Institute classification, shall be permitted in preservative treated wood above or below grade. Fasteners or fastener materials not otherwise permitted under this article shall be permitted if adequate comparative tests for durability, including the effects associated with wood treating chemicals, demonstrate performance equal to or greater than the specified fasteners or fastener materials.

(b) *Materials.* All lumber and plywood shall be treated in accordance with the following adopted standard and shall be identified as to conformance with such standard by an approved inspection agency:

1. **AWPB FND.**

Note: See s. Comm 53.64 concerning wood foundations.

History: Cr. Register, July, 1974, No. 223, eff. 1-1-75; am. (2) Register, December, 1974, No. 228, eff. 1-1-75; r. and recr. (2), Register, April, 1975, No. 232, eff. 5-1-75; am. (1) (a), (3) and (8) (intro.), cr. (9), Register, December, 1978, No. 276, eff. 1-1-79; reprinted to correct printing error in (8), Register, April, 1980, No. 292; am. (2), Register, December, 1981, No. 312, eff. 1-1-82; am. (9) (a) (intro.), renum. (9) (a) 1.a. to be (9) (a) 2., r. (9) (a) 1.b., Register, December, 1983, No. 336, eff. 1-1-84; am. (1) (a) (intro.), 1. b., (2) (a) and (b), (3), (5) (a), (8) (intro.), (9) (a) 1. and (b) 1., r. and recr. (1) (a) 1. c., r. (6), Register, March, 1991, No. 423, eff. 4-1-91; am. (1) (a) 1. c., Register, January, 1994, No. 457, eff. 2-1-94.

Comm 53.62 Special systems. (1) WOOD TRUSSES. Wood trusses shall be constructed in accordance with the following recommended standard and the listed exceptions:

(a) TPI-85.

1. Exceptions and additions:

a. Section 302.2. Moment coefficients used in the design of top chord members shall be based on the assumption of no fixity at member ends or joints due to plate connectors. Moment and buckling factors as indicated in section 3.2 of TPI-85 are acceptable.

b. Metal plate connectors shall be identifiable as stated in s. Comm 53.61 (8) (a).

c. The modification of design stresses for duration of load shall be as specified in s. Comm 53.61 (1) (a) 1. c.

(b) For trusses with nail-glued plywood gusset plates, calculations and design reference source shall be submitted to the department.

(c) Mechanically fastened trusses shall conform to section 8.4, "Timber Connector Joints," of National Design Specification.

History: Cr. Register, July, 1974, No. 223, eff. 1-1-75; cr. (1) (a) 1.c., Register, December, 1974, No. 228, eff. 1-1-75; am. (1) (c), Register, December, 1978, No. 276, eff. 1-1-79; am. (1), Register, February, 1979, No. 278, eff. 3-1-79; am. (1) (a) 1.a., Register, January, 1980, No. 289, eff. 2-1-80; r. and recr. (1) (a) (intro.), am. (1) (a) 1. a. and (c), Register, March, 1991, No. 423, eff. 4-1-91.

Comm 53.63 Minimum construction requirements. The requirements of this section shall apply to all wood framing.

Note: Recognized wood framing and construction details indicated in "Wood Construction Data No. 1 and No. 5" of the National Forest Products Association, Technical Services Division (1619 Massachusetts Ave. NW, Washington, D.C. 20036) is recommended as good design and construction practice.

(2) **DRAFTSTOPPING.** (a) Where a ceiling is suspended below solid wood floor joists, or either suspended or attached directly to the bottom of open web floor trusses, the space between the ceiling and the floor above shall be divided by draftstopping into areas, whichever is the least, as follows:

1. At rental tenant separation walls, if the walls do not extend above to the floor sheathing;

2. At living unit separation walls; if the walls do not extend above to the floor sheathing; or

3. Into areas not exceeding 1,000 square feet.

(b) Draftstopping as required in this subsection shall be at least 1/2 inch gypsum board, 3/8 inch plywood or other equivalent materials which are adequately supported.

(3) **WOOD FRAMING INTO FIRE-RATED MASONRY WALLS.** See s. Comm 51.045 (1) (m).

(4) FIRE-CUTTING. Wood members supported in masonry walls shall have the ends of such members splayed or firecut to allow free end rotation in the vertical plane of the member, out of the masonry wall. See also s. Comm 53.34 (3) (b) 5.b.

TABLE 53-XVIII
MAXIMUM SPACING AND HEIGHT OF STUDS

Size	Grade Referring to Fb and Fc	Height (Feet)	Spacing (Inches)	
			Exterior or Load-Bearing	Interior & Nonload-Bearing
2 by 4 or larger	Utility	8	16	24
2 by 3	Standard and better	8	16	16
2 by 4—3 by 4	Standard and better	12	16	24
2 by 6 or larger	Standard and better	18	24	24

TABLE 53-XIX
MINIMUM RECOMMENDED NAILING SCHEDULE

Connection	Nailing (using common nails)
Joist to sill or girder, toe nail	3-8d
Bridging to joist, toe nail each end	2-8d
Ledger strip	3-16d at each joist
1G x 6G subfloor or less to each joist, face nail	2-8d
Over 1G x 6G subfloor to each joist, face nail	3-8d
2G subfloor to joist or girder, blind and face nail	2-16d
Sole plate to joist or blocking, face nail	16d at 16" oc
Top plate to stud, end nail	2-16d
Stud to sole plate, toe nail	4-8d
Doubled studs, face nail	16d at 24" oc
Doubled top plates, face nail	16d at 16" oc
Top plates, laps and intersections, face nail	2-16d
Continuous header, two pieces	16d at 16" oc along each edge
Ceiling joists to plate, toe nail	3-8d
Continuous header to stud, toe nail	4-8d
Ceiling joists, laps over partitions, face nail	3-16d
Ceiling joists to parallel rafters, face nail	3-16d
Rafter to plate, toe nail	3-8d
One-inch brace to each stud and plate, face nail	2-8d
1G x 8G sheathing or less to each bearing, face nail	2-8d
Over 1G x 8G sheathing to each bearing, face nail	3-8d
Built-up corner studs	16d at 24" oc
Built-up girders and beams	20d at 32" oc along each edge

(5) **BEARING.** (a) *Joists and trusses.* The ends of each joist or truss shall have not less than 1½-inch length of bearing on wood or metal nor less than 3-inch length on hollow or solid masonry units.

(b) *Beams and girders.* The ends of beams or girders supported on masonry or concrete shall have not less than 4-inch length of bearing. See also s. Comm 53.34 (3).

(6) **NOTCHING AND DRILLING.** No notching of outer fibers of structural members is permitted unless substantiated by design calculations. Circular holes bored in joists and studs that are within the middle one-third of the depth of joist or studs are permitted without design calculations.

(7) **DECAY PREVENTION.** Where wood is used in parts of a building exposed to moisture that causes the moisture content of wood to exceed 19%, the wood shall be adequately ventilated or treated with preservative. All lumber and plywood required to be treated with a preservative shall be identified by a quality mark or certificate of inspection of an approved inspection agency which maintains continued supervision, testing and inspection over the quality of the product in accordance with the adopted standards of the American Wood Preservers Bureau.

(a) All wood columns, posts and frame legs whose base is subject to deterioration due to moisture shall bear on concrete or other inorganic materials which extend at least 3 inches above the adjacent surface unless treated with preservative.

(b) The ends of wood structural members built into exterior masonry walls or into concrete shall be treated with preservative or a moisture-proof barrier shall be installed on the bearing surface.

Note: In areas subject to termite attack, refer to "Design of Wood Structures for Permanence" (published by the National Forest Products Association, 1619 Massachusetts Ave. NW, Washington, D.C. 20036) as suggested by National Design Specifications, Appendix F, section B.2.

(8) **TRUSS BRACING AND ANCHORAGE.** All wood trusses shall be securely fastened to the supports and each truss shall be secured in position in accordance with National Design Specification, Appendix A, section A.10.

(9) **ANCHORAGE.** Anchorage shall be in accordance with s. Comm 53.12 (2).

(10) **CROSS BRIDGING.** Cross bridging shall be furnished in accordance with section 4.4.1 of NDS. When joists support floor

or roof decks other than wood or wood decks which are not adequately attached, cross bridging shall be provided at 8-foot intervals.

(11) **SOLID BLOCKING.** All floor and roof joists shall be supported laterally at the ends and at each support by solid blocking or other approved methods. Solid blocking shall be not less than 2 inches in nominal thickness and the full depth of the joist.

(12) **JOIST SUPPORT.** Floor or roof joists shall not be toe nailed into the side of beams and girders for support. Such joists shall be supported by joist hangers, ledgers or metal plate connectors of adequate structural capacity.

(13) **STUD WALLS.** Unless evidence is provided to indicate otherwise, the maximum spacing and height of studs shall be in accordance with Table 53-XVIII. Notching and drilling of studs shall conform to sub. (5). Where load-bearing studs are spaced at 24-inch intervals, the roof trusses, rafters, and joists shall be centered over the studs or, in lieu thereof, solid blocking equal in size to the studs shall be installed to reinforce the double plate above.

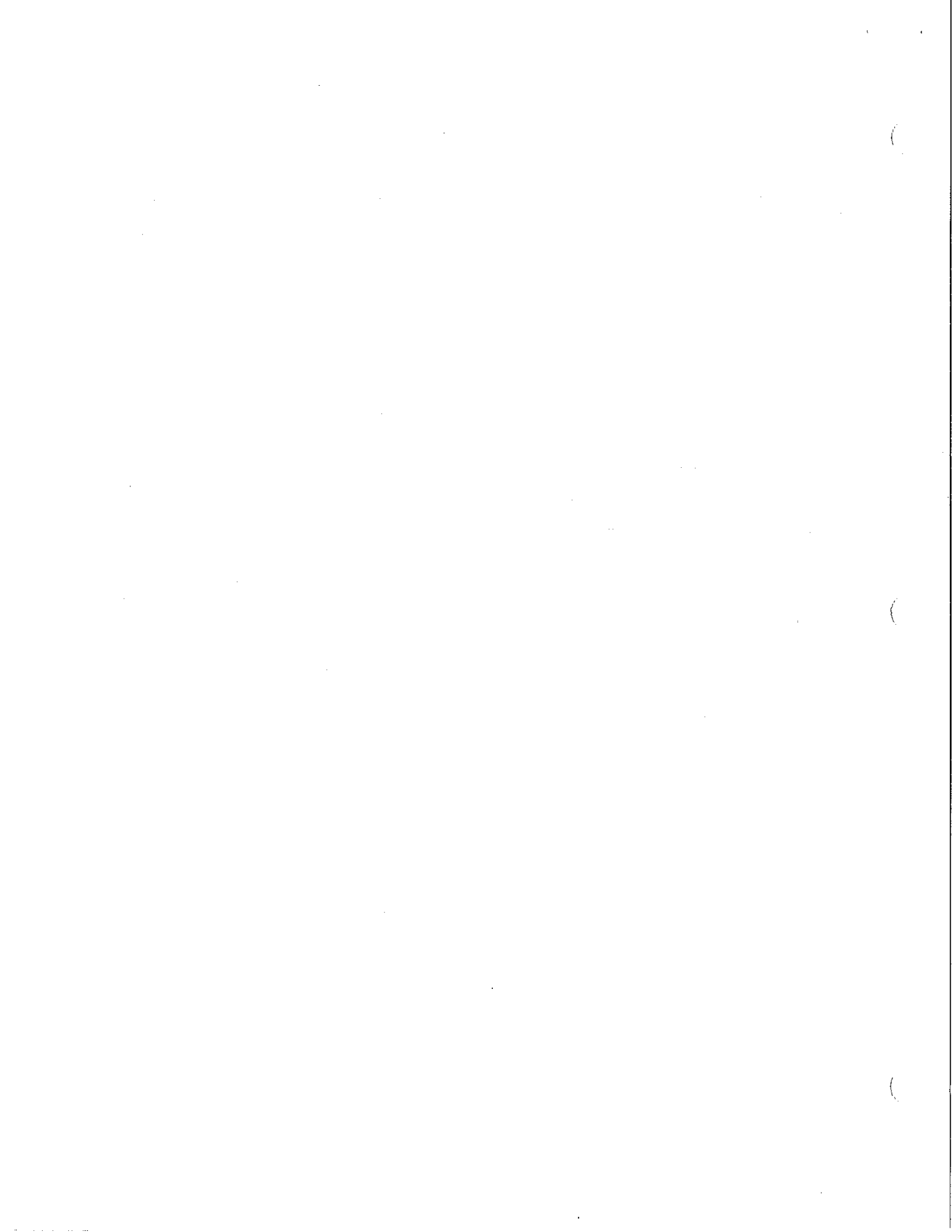
(14) **MINIMUM RECOMMENDED NAILING SCHEDULE.** Unless evidence of design for the connection is provided, the connection shall have a minimum nailing in accordance with Table 53-XIX or its equivalent.

History: Cr. Register, July, 1974, No. 223, eff. 1-1-75; am. (6) (intro.), Register, December, 1976, No. 252, eff. 1-1-77; am. (7) and (9), Register, March, 1979, No. 278, eff. 3-1-79; am. (1) and (6) (intro.), Register, December, 1981, No. 312, eff. 1-1-82; am. (10), Register, August, 1985, No. 356, eff. 1-1-86; am. (1) (d), renam. (2) to (13) to be (3) to (14) and am. (8) and (10), cr. (2), Register, March, 1991, 423, eff. 4-1-91; am. (1) (d), Register, January, 1994, No. 457, eff. 2-1-94; am. (1) (a), (c), and (d), Register, September, 1998, No. 513, eff. 10-1-98; r. (1), Register, March, 2000, No. 531, eff. 4-1-00.

Comm 53.64 Wood foundations. Foundations may be constructed of treated wood when the design is based upon the soil bearing values contained in s. Comm 53.21 and the structural design is in accordance with the standards listed in s. Comm 53.61. All pressure-treated wood and plywood shall be treated and identified in accordance with adopted standards of the American Wood Preservers Bureau.

Note: See Appendix A for further explanatory material.

History: Cr. Register, December, 1978, No. 276, eff. 1-1-79; am., Register, December, 1981, No. 312, eff. 1-1-82; am. Register, March, 1991, No. 423, eff. 4-1-91.



Chapter Comm 54

FACTORIES, OFFICE AND MERCANTILE BUILDINGS

Comm 54.001	Scope.
Comm 54.01	Construction, height and allowable area.
Comm 54.02	Number and location of exits.
Comm 54.03	Type of exits.
Comm 54.04	Required exit width.
Comm 54.05	Capacity of buildings.
Comm 54.06	Exit doors.
Comm 54.07	Exit access.
Comm 54.08	Enclosure of stairways and shafts.
Comm 54.10	Trap doors and floor openings.
Comm 54.105	Toeboards.

Comm 54.11	Lighting.
Comm 54.12	Sanitary facilities.
Comm 54.13	Change rooms and lunchrooms.
Comm 54.145	Occupancy separations and hazard enclosures.
Comm 54.15	Fire protection systems.
Comm 54.17	Fire alarms.
Comm 54.18	Floor load signs.
Comm 54.19	Signs indicating number of persons.
Comm 54.20	No smoking signs.
Comm 54.21	Tents.

Note: Chapter Ind 54 was renumbered to be chapter ILHR 54 effective January 1, 1984. Corrections made under s. 13.93 (2m) (b) 7., Stats., Register, March, 1997, No. 495. Chapter ILHR 54 was renumbered to be chapter Comm 54 under s. 13.93 (2m) (b) 1. and corrections were made under s. 13.93 (2m) (b) 7., Stats., Register, December, 1997, No. 504.

Comm 54.001 Scope. This classification includes all factories and workshops (including all places where manual labor is employed), office buildings, telegraph and telephone offices, mercantile establishments where commodities are bought or sold, clothes cleaning establishments, warehouses, railroad stations, exhibition buildings, public mausoleums, crematoriums, and places where not more than 100 persons assemble for recreation, entertainment, worship, or dining purposes.

Note: See ch. Comm 7 for other provisions relating to setbacks and construction for a magazine within which explosives are stored.

Note: The department of health and family services may require additional provisions for the federal certification of ambulatory surgical offices and clinics which receive federal funding.

History: 1-2-56; am. Register, December, 1981, No. 312, eff. 1-1-82; am. Register, March, 1992, No. 435, eff. 4-1-92; am. Register, December, 1993, No. 456, eff. 1-1-94.

Comm 54.01 Construction, height and allowable area. (1) GENERAL. Buildings and structures within the scope of this chapter may not exceed the height and area limitations specified in this section.

Note: See s. Comm 51.03 for standards of classes of construction.

(2) LIMITED AREA CH. COMM 54 BUILDINGS. (a) Chapter Comm 54 buildings not protected by complete automatic fire sprinkler protection may not exceed the height and area limitations specified in Table 54.01-1.

(b) Chapter Comm 54 buildings protected by complete automatic fire sprinkler systems may not exceed the height and area limitations specified in Table 54.01-2.

(3) FIRE DIVISION WALL SEPARATION. (a) No building shall be limited in area when divided into sections which do not exceed the maximum areas tabulated in this section by fire division walls specified in s. Comm 51.02 (13).

(b) All openings in such walls shall be protected by fire-resistant door assemblies as specified in s. Comm 51.047.

1. Except as provided in subd. 2., doors protecting such openings may be left open if equipped with an automatic closing device activated by products of combustion other than heat.

2. a. The automatic closing device may be installed to prevent accidental closing of the fire door in the event of a power outage to the building if it is installed with an approved or listed backup mechanism in addition to the smoke detection release device.

b. The automatic closing device on doors located in smoke- or contaminant-filled environments, such as but not limited to foundries, chemical plants and similar environments, may be activated by rate-of-rise heat detectors.

3. Doors used as required exits shall be standard exit doors and shall comply with the requirements of s. Comm 51.19 (2).

(4) UNLIMITED AREAS. (a) The area of buildings completely protected by an automatic fire sprinkler system may be unlimited provided the following conditions are satisfied:

1. The maximum number of stories is limited as follows:

a. Type No. 2 construction — 9 stories;

b. Type No. 3 construction — 5 stories;

c. Type No. 4 and 5A construction — 3 stories; and

d. Type No. 5B and 6 construction — 2 stories involving not more than 4 floor levels.

2. Street access is provided as specified in sub. (5) (b).

(b) There shall be no area restriction in one-story buildings where the following conditions are satisfied:

1. Construction of all building elements listed in Table 51.03-A are of noncombustible materials. Built-up roof coverings may not be used;

2. a. The contents of the building are noncombustible;

b. Stored materials are not packed or crated in combustible materials; and

3. Street access is provided as specified in sub. (5) (b).

TABLE 54.01-1 — ALLOWABLE HEIGHT (STORIES) AND AREA (SQARE FEET) FOR BUILDINGS WITHOUT COMPLETE AUTOMATIC FIRE SPRINKLER SYSTEM PROTECTION (MAXIMUM GROSS FLOOR AREA PER FLOOR)
NOTE: DO NOT USE FOR BUILDINGS EXCEEDING 60 FEET IN HEIGHT

CLASS OF CONSTRUCTION	BUILDING FRONTAGE STREET EXPOSURE	NUMBER OF STORIES								
		1	2	3	4	5	6	7	8	Over 8
1. Fire-Resistive Type A	1	25,000	22,000	19,000	16,000	13,000	11,000	9,000	8,000	6,000
	2	30,500	27,000	24,000	20,500	17,500	15,000	13,000	12,000	10,000
	3	36,000	33,000	29,000	25,000	22,000	19,000	17,000	16,000	14,000
	4	41,500	39,000	34,000	29,500	26,500	23,000	21,000	20,000	18,000
2. Fire-Resistive Type B	1	23,000	20,000	17,000	14,000	11,000	9,000	7,000	6,000	N.P.
	2	28,000	25,000	22,000	18,500	15,500	13,000	11,000	10,000	N.P.
	3	34,000	31,000	27,000	23,000	20,000	17,000	15,000	14,000	N.P.
	4	39,500	37,000	32,000	27,500	24,500	21,000	19,000	18,000	N.P.
3. Metal Frame Protected	1	21,000	18,000	15,000	12,000	N.P.	N.P.	N.P.	N.P.	N.P.
	2	26,500	23,000	19,500	16,000	N.P.	N.P.	N.P.	N.P.	N.P.
	3	32,000	28,000	24,000	20,000	N.P.	N.P.	N.P.	N.P.	N.P.
	4	37,500	33,000	28,500	24,000	N.P.	N.P.	N.P.	N.P.	N.P.
4. Heavy Timber	1	17,000	14,000	11,000	9,000	N.P.	N.P.	N.P.	N.P.	N.P.
	2	22,000	19,000	16,000	13,500	N.P.	N.P.	N.P.	N.P.	N.P.
	3	27,000	24,000	21,000	18,000	N.P.	N.P.	N.P.	N.P.	N.P.
	4	32,000	29,000	26,000	22,500	N.P.	N.P.	N.P.	N.P.	N.P.
5A. Exterior Masonry Protected	1	15,500	13,500	9,500	8,000	N.P.	N.P.	N.P.	N.P.	N.P.
	2	20,000	17,000	14,000	12,500	N.P.	N.P.	N.P.	N.P.	N.P.
	3	24,500	21,500	18,500	15,500	N.P.	N.P.	N.P.	N.P.	N.P.
	4	29,000	26,000	23,000	19,500	N.P.	N.P.	N.P.	N.P.	N.P.
5B. Exterior Masonry Unprotected	1	14,000	11,500	9,000	N.P.	N.P.	N.P.	N.P.	N.P.	N.P.
	2	18,000	15,000	12,500	N.P.	N.P.	N.P.	N.P.	N.P.	N.P.
	3	22,000	19,000	16,000	N.P.	N.P.	N.P.	N.P.	N.P.	N.P.
	4	26,000	23,000	19,500	N.P.	N.P.	N.P.	N.P.	N.P.	N.P.
6. Metal Frame Unprotected	1	14,000	11,500	9,000	N.P.	N.P.	N.P.	N.P.	N.P.	N.P.
	2	18,000	15,000	12,500	N.P.	N.P.	N.P.	N.P.	N.P.	N.P.
	3	22,000	19,000	16,000	N.P.	N.P.	N.P.	N.P.	N.P.	N.P.
	4	26,000	23,000	19,500	N.P.	N.P.	N.P.	N.P.	N.P.	N.P.
7. Wood Frame Protected	1	12,500	7,500	5,500	N.P.	N.P.	N.P.	N.P.	N.P.	N.P.
	2	16,000	10,000	7,000	N.P.	N.P.	N.P.	N.P.	N.P.	N.P.
	3	19,000	12,000	8,500	N.P.	N.P.	N.P.	N.P.	N.P.	N.P.
	4	22,000	14,000	10,000	N.P.	N.P.	N.P.	N.P.	N.P.	N.P.
8. Wood Frame Unprotected	1	10,000	5,000	N.P.	N.P.	N.P.	N.P.	N.P.	N.P.	N.P.
	2	12,000	6,000	N.P.	N.P.	N.P.	N.P.	N.P.	N.P.	N.P.
	3	14,000	7,000	N.P.	N.P.	N.P.	N.P.	N.P.	N.P.	N.P.
	4	16,000	8,000	N.P.	N.P.	N.P.	N.P.	N.P.	N.P.	N.P.

N.P. MEANS NOT PERMITTED

TABLE 54.01-2 — ALLOWABLE HEIGHT (STORIES) AND AREA (SQURE FEET) FOR BUILDINGS COMPLETELY PROTECTED BY AUTOMATIC FIRE SPRINKLER SYSTEM (MAXIMUM GROSS FLOOR AREA PER FLOOR) NOTE: USE FOR ALL BUILDINGS

CLASS OF CONSTRUCTION	BUILDING FRONTAGE STREET EXPOSURE	NUMBER OF STORIES									
		1	2	3	4	5	6	7	8	9	Over 9
1. Fire-resistive Type A stories and area may be unlimited subject to s. Comm 54.01 (5) (b)	1	NO LIMIT									
	2	NO LIMIT									
	3	NO LIMIT									
	4	NO LIMIT									
2. Fire-resistive type B 1 to 9 story area may be unlimited subject to s. Comm 54.01 (5) (b)	1		69,000	60,000	51,000	42,000	33,000	27,000	21,000	18,000	N.P.
	2	NO	85,500	75,000	66,000	55,500	46,500	39,000	33,000	30,000	
	3	LIMIT	102,000	93,000	81,000	69,000	60,000	51,000	45,000	42,000	
	4		118,500	111,000	96,000	82,500	73,500	63,000	57,000	54,000	
3. Metal frame protected 1 to 5 story area may be unlimited subject to s. Comm 54.01 (5) (b)	1	84,000	63,000	54,000	45,000	36,000	N.P.	N.P.	N.P.	N.P.	N.P.
	2	106,000	79,500	69,000	58,500	48,000					
	3	128,000	96,000	84,000	72,000	60,000					
	4	150,000	112,500	99,000	85,500	72,000					
4. Heavy Timber 1 to 3 story area may be unlimited subject to s. Comm 54.01 (5) (b)	1	68,000	51,000	42,000	33,000	27,000	N.P.	N.P.	N.P.	N.P.	N.P.
	2	88,000	66,000	57,000	48,000	40,500					
	3	108,000	81,000	72,000	63,000	54,000					
	4	128,000	96,000	87,000	78,000	67,500					
5A. Exterior Masonry Protected 1 to 3 story area may be unlimited subject to s. Comm 54.01 (5) (b)	1	62,000	46,500	40,500	28,500	24,000	N.P.	N.P.	N.P.	N.P.	N.P.
	2	80,000	60,000	51,000	42,000	37,500					
	3	98,000	73,500	64,500	55,500	46,500					
	4	116,000	87,000	78,000	69,000	58,500					
5B. Exterior Masonry Unprotected 1 story area may be unlimited subject to s. Comm 54.01 (5) (b)	1	56,000	42,000	34,500	27,000	N.P.	N.P.	N.P.	N.P.	N.P.	N.P.
	2	72,000	54,000	45,000	37,500						
	3	88,000	66,000	57,000	48,000						
	4	104,000	78,000	69,000	58,500						
6. Metal Frame Unprotected 1 story area may be unlimited subject to s. Comm 54.01 (5) (b)	1	56,000	42,000	34,500	27,000	N.P.	N.P.	N.P.	N.P.	N.P.	N.P.
	2	72,000	54,000	45,000	37,500						
	3	88,000	66,000	57,000	48,000						
	4	104,000	78,000	69,000	58,500						
7. Wood Frame Protected	1	50,000	37,500	22,500	16,500	N.P.	N.P.	N.P.	N.P.	N.P.	N.P.
	2	64,000	48,000	30,000	21,000						
	3	76,000	57,000	36,000	25,500						
	4	88,000	66,000	42,000	30,000						
8. Wood Frame Unprotected	1	40,000	30,000	15,000	N.P.	N.P.	N.P.	N.P.	N.P.	N.P.	N.P.
	2	48,000	36,000	18,000							
	3	56,000	42,000	21,000							
	4	64,000	48,000	24,000							

N.P. MEANS NOT PERMITTED

(5) STREET ACCESS TO BUILDINGS. (a) Streets shall be within 50 feet of the adjacent building side with no obstructions between the street and the building which will impede fire-fighting efforts.

Note: See s. Comm 51.01 (124) for definition of street.

(b) 1. Unlimited area buildings of fire-resistive type 1 construction and one-story unlimited area buildings of fire-resistive type 2 construction shall be provided with street access as defined in s. Comm 51.01 (124) to at least one side of the building.

2. Unlimited area buildings of type 3 through type 6 construction shall have a continuous all-weather, hard-surfaced area 30 feet or more in width for a distance of not less than 50% of the perimeter of the building. These buildings shall have at least one wall facing a street for its entire length. At least 2 of the remaining building walls shall face streets for at least 50% of their respective lengths.

(6) HEIGHT EXCEPTIONS. Rack storage facilities of noncombustible construction protected with automatic fire sprinkler systems installed in accordance with NFPA No. 231C — Standard for Rack Storage of Materials, may be of unlimited height.

(7) PUBLIC MAUSOLEUM CONSTRUCTION. Public mausoleum structures shall be constructed in accordance with s. Comm 51.03 and mausoleum spaces shall be constructed of reinforced concrete.

History: 1-2-56; am. (2) and (3), Register, September, 1959, No. 45, eff. 10-1-59; am. (3), Register, February, 1971, No. 182, eff. 7-1-71; r. and recr. (3), eff.

8-1-71 and exp. 1-1-72; cr. (3) eff. 1-1-72, Register, July, 1971, No. 187; r. and recr. (1) and (2), Register, June, 1972, No. 198, eff. 1-1-73; r. and recr. (2) and (3), Register, September, 1973, No. 213, eff. 10-1-73; cr. (2) a, Register, December, 1977, No. 264, eff. 1-1-78; am. (2) (b) 2, a. and (2) (c), cr. (4), Register, November, 1978, No. 276, eff. 1-1-79; am. (3), Register, January, 1980, No. 289, eff. 2-1-80; r. and recr. table, am. (2) (b) 2. and (3), Register, December, 1981, No. 312, eff. 1-1-82; reprinted to correct errors in Table 54.01 and (2) (b) 2., Register, February, 1982, No. 314; am. (3), Register, December, 1983, No. 336, eff. 1-1-84; renum. (2) (a) and (c) to be (2) (a) 1. and (d), (2) (a) 2. renum. and am. from ILHR 54.23, am. (2) (b) 1. and 2., r. and recr. (2) (b) 3., cr. (2) (c), Register, August, 1985, No. 356, eff. 1-1-86; emerg. r. and recr. (1) to (4), cr. (5) and (6) and tables 54.01-1 and 54.01-2, r. table 54.01, eff. 9-6-86; r. and recr. (1) to (4), cr. (5), (6) and tables 54.01-1 and 54.01-2, r. table 54.01, Register, November, 1986, No. 371, eff. 12-1-86; am. (4) (a) 1. d., Register, March, 1991, No. 423, eff. 4-1-91; cr. (7), Register, March, 1992, No. 435, eff. 4-1-92; renum. (5) (b) 1. and 2. to be 2. and 1. and am. 2., Register, January, 1994, No. 457, eff. 2-1-94; r. (2) (c), Register, March, 2000, No. 531, eff. 4-1-00.

Comm 54.02 Number and location of exits. (1) NUMBER OF EXITS. Every building and every floor level thereof shall have at least 2 exits.

(2) EXCEPTIONS. One exit will be permitted in the following conditions:

(a) Floor levels used entirely for storage in buildings 2 stories or less in height and not over 3,000 square feet gross area per floor.

(b) Interior balconies or mezzanine floors not over 3,000 square feet gross area used entirely for storage.

(c) Open interior balconies or open mezzanine floors not over 750 square feet gross area used for purposes other than nonoccupied storage.

(d) One-story office buildings, without a basement or mezzanine, having a gross floor area, per floor, of not more than 1,800 square feet. Only one office operation per floor level shall be permitted. The single exit from the first floor or ground floor(s) shall have an outside exit serving only that floor level.

(e) Retail establishments not over 750 square feet net area, provided there are 2 directions for exiting from the entrance door of the store.

(f) Enclosed interior mezzanine floors, not over 750 square feet gross area, that are used for office space, where the distance to the exit is no more than 100 feet in an unsprinklered building, or no more than 150 feet in a building completely protected by an approved automatic sprinkler system, provided:

1. Each wall facing the lower level is a minimum of 30% glazed with vision panels; and

2. Smoke detection in accord with NFPA 72, or an equivalent system acceptable to the department, is provided to all parts of the building within 100 feet of the mezzanine, with the detectors on the main floor and a horn in the mezzanine level.

(3) OFFICE SUITE EXITING. One exit or exit access may be permitted from office suites having a floor area of not more than 1,800 square feet net area, provided there are 2 directions for exiting from the exit or exit access from the suite, and provided the exit distance within the suite, to the exit or exit access from the suite, does not exceed 75 feet in an unsprinklered building, or 100 feet in a completely sprinklered building.

Note: See Appendix A for further explanatory material.

(4) EXIT DISTANCE. (a) Exits shall be distributed or located so that no part of any building within the scope of this chapter will be more than 150 feet distant from an exit.

Note: See Appendix A for further explanatory material.

(b) Where an approved automatic fire sprinkler system is provided throughout the building, an increase in exit distance to 200 feet will be permitted for mercantile buildings and an increase in exit distance to 300 feet will be permitted in all other buildings within the scope of this chapter, except high hazard buildings.

(c) Buildings having contents which are liable to burn with extreme rapidity or from which poisonous fumes may be liberated or explosions occur in case of fire, shall have exits provided so that the maximum distance to exit is limited to 75 feet.

Note: See s. A52.011 of Appendix A for further information relating to "high hazard" occupancies.

(d) All of the above distances shall be measured along public passageways and aisles.

Note: Also see s. Comm 54.08 (1) for alternate exit distance provisions.

(5) EXIT DISTRIBUTION. Exits in all buildings of this classification shall be so located and distributed so as to afford the best possible egress.

History: 1-2-56; cr. (1) (c), Register, September, 1959, No. 45, eff. 10-1-59; am. (1) (b), Register, February, 1971, No. 182, eff. 7-1-71; r. and recr. (1) (b) eff. 8-1-71 and exp. 1-1-72, and cr. (1) (b) eff. 1-1-72, Register, July, 1971, No. 187; am. (1), Register, September, 1973, No. 213, eff. 10-1-73; r. and recr. Register, December, 1978, No. 276, eff. 1-1-79; am. (4), Register, January, 1980, No. 289, eff. 2-1-80; am. (4), Register, December, 1981, No. 312, eff. 1-1-82; emerg. am. (4) (b), eff. 9-6-86; am. (4) (b), Register, November, 1986, No. 371, eff. 12-1-86; cr. (2) (f) am. (3), Register, January, 1994, No. 457, eff. 2-1-94; am. (2) (f) 2., Register, February, 1999, No. 518, eff. 3-1-99.

Comm 54.03 Type of exits. (1) At least one-half of the exits required in accordance with s. Comm 54.02 shall be stairways or standard exits to grade as specified in ss. Comm 51.15 to 51.18. The other exits shall be either stairways, standard exits, or horizontal exits as specified in s. Comm 51.19, or fire escapes as specified in s. Comm 51.20. A fire escape will not be accepted as a required exit for any building level more than 5 stories or 55 feet above grade. An outside wooden stairway may be used as an exit for a 2-story building.

(a) *Exception.* The width of required exit stairways serving unoccupied areas (i.e., storage areas, equipment mezzanines and similar areas) not exceeding 750 square feet may be reduced to 3 feet 0 inches.

(b) *Exception.* Less than 3 risers may be used to elevated work stations (such as pharmacy floors, computer floors and similar areas) or to altars, podiums and similar areas, not in a required exit passageway.

(c) *Exception.* A spiral stairway may be used as a nonrequired convenience stairway in addition to all other required exit stairways in places of employment.

(d) *Exception.* A rescue platform (exterior balcony) of combustible construction may be used as a required second exit for buildings of type 5, 6, 7 and 8 construction, provided all of the following conditions are satisfied:

1. The exit serves 8 or less people;

2. The exit platform is located not more than 15 feet above the adjacent exit discharge grade;

3. The platform area is at least 14 square feet, with a minimum dimension of 3 feet;

4. The platform is designed for 80 pounds per square foot live load plus dead load;

5. Railings are provided in accordance with the provisions of s. Comm 51.162;

6. Platforms having solid floors are provided with a roof equal in area to that of the platform;

7. All wood used in the construction of the rescue platform shall be pressure treated wood satisfying the requirements of the applicable standards specified in s. Comm 53.63 (6) unless the wood is inherently resistant to decay; and

8. The exit door to the platform is not less than 2 feet 6 inches in width.

(2) Every building which will accommodate more than 50 persons above the second story shall have at least 2 stairways.

(3) Wherever stairways are required under this classification, ramps with a slope not greater than one foot in 8 feet may be substituted. Ramps shall comply with all the requirements for stairways as to construction, enclosures, width, landing and lighting, and shall be surfaced with an approved non-slip material.

History: 1-2-56; am. (1), Register, December, 1974, No. 228, eff. 1-1-75; cr. (1) (a) to (d), eff. 1-1-78; am. (1) (b), Register, December, 1978, No. 276, eff. 1-1-79; am. (1) (d) 5. and (3), Register, January, 1980, No. 289, eff. 2-1-80; am. (1) (d) (intro.) 5. and 6., cr. (1) (d) 7., Register, December, 1983, No. 336, eff. 1-1-84; am. (1) (d) (intro.), 6. and 7., cr. (1) (d) 8., Register, March, 1991, No. 423, eff. 4-1-91; am. (1) (d) (intro.), Register, January, 1994, No. 457, eff. 2-1-94; am. (1) (d) 2., Register, March, 1995, No. 471, eff. 4-1-95; correction in (1) (d) 7. made under s. 13.93 (2m) (b) 7., Stats., Register, September, 1998, No. 513.

Comm 54.04 Required exit width. (1) The total required exit width from a building level shall be in accordance with the requirements of ss. Comm 51.15 (6) and 51.16 (3).

(2) Standard fire escapes (s. Comm 51.20) may be substituted for stairways to the extent of not more than 1/3 of the required total width, subject to the provision of s. Comm 54.02.

(3) Horizontal exits in accordance with the requirements of s. Comm 51.19 may provide up to one-half of the required exit width for any floor, subject to the provisions of s. Comm 54.02.

History: 1-2-56; am. (1) (a) and (b) and (3) (a) and (b), Register, June, 1972, No. 198, eff. 1-1-73; r. and recr. (1) and (3), r. (4), Register, December, 1974, No. 228, eff. 1-1-75.

Comm 54.05 Capacity of buildings. (1) In calculating the aggregate width of exits, the capacity of a building shall be established as follows:

(a) Stores, first floor and basement ---- 30 sq. ft. per person

(b) Stores, second floor and above ---- 60 sq. ft. per person

(c) Dining rooms, cafes, taverns, etc. -- 10 sq. ft. per person

(d) Places of seated assemblage ----- 7 sq. ft. per person

(e) Warehouses ----- 300 sq. ft. per person

(f) Factories and offices ----- 75 sq. ft. per person

(g) Swimming pool rooms ----- 10 square feet per person for deck area.

(2) The above figures are based on the net area of each occupied space. Where dining rooms, cafes, dance halls and places of seated assemblage accommodate more than 100 persons, see s. Comm 55.01.

(3) In other occupancies not specified above, the capacity shall be determined by the actual number of persons liable to be accommodated therein and no greater number of persons will be permitted therein.

(4) For determining the number of sanitary fixtures required in all uses covered by this chapter, the number of occupants determined in accordance with subs. (1), (2), or (3) shall be used, unless a different number of occupants is approved by the department or its authorized representative.

History: 1-2-56; cr. (1) (g), Register, January, 1994, No. 457, eff. 2-1-94; am. (1) (Intro.), cr. (4), Register, September, 2000, No. 537, eff. 10-1-00.

Comm 54.06 Exit doors. (1) GENERAL. Every door which serves as an exit from a building, public passageway or stairway shall be a standard exit door as specified in s. Comm 51.15, except:

(a) Exit doors serving 25 or fewer persons need not swing in the direction of egress;

(b) Exit access doors serving 25 or fewer persons may be reduced in width to 2 feet 8 inches and may be a sliding or accordion-type door;

(c) Rolling, sliding and overhead types of doors or gates may be used as standard exit doors for tenant spaces in malls provided:

1. The door or gate is equipped with exit hardware in accordance with s. Comm 51.15 (3);

2. The door or gate is counterbalanced such that it can be opened by a force not exceeding 12 pounds, or, if the door or gate is electrically operated, the door is supplied by an emergency power source capable of opening the door or gate;

3. The door or gate is maintained in a fully opened position during the business hours of the tenant space;

4. A security device permitted by s. Comm 51.15 (3) (e) 2. is not engaged when the tenant space is occupied; and

5. Manual, chain hoist operators for the doors or gates are not employed.

(2) **ILLUMINATED EXIT SIGNS.** Every exit door from each floor level, other than the principal entrance for the building, shall be marked with an exit sign as specified in s. Comm 51.15 (5).

(3) **SECURITY GATES.** Exterior security gates shall be permitted to protect exterior exit doors in accordance with this subsection.

(a) A security gate may not be closed or locked when the building or portion of the building protected by the security gate is occupied.

(b) When the gate is locked in place the gate shall be visible from the exterior of the building.

(c) A security gate may not be locked over exit doors which serve more than one building occupancy or tenant space.

(d) The locking device for a security gate which requires the use of a key or a combination to open it shall be accessible from the exterior of the building.

(e) The building owner shall send to the local fire department and building inspection department a letter indicating that a security gate is to be installed and maintained in accordance with this section.

(f) The department or its authorized deputies shall have the authority to revoke the use of any security gate for any exterior exit door upon the violation of any one provision specified in pars. (a) to (e).

History: 1-2-56; am. (1), Register, December, 1978, No. 276, eff. 1-1-79; am. Register, January, 1980, No. 289, eff. 2-1-80; am. Register, December, 1983, No. 336, eff. 1-1-84; r. and recr. Register, March, 1991, No. 423, eff. 4-1-91.

Comm 54.07 Exit access. (1) Where there is not direct access to an exit or exits from an area within a building, exit access corridors, passageways, or aisles shall be provided to lead to the exit or exits.

(2) (a) The width of a corridor, passageway or aisle which provides access to an exit shall be at least:

1. Three feet, if the corridor, passageway or aisle serves a space with an occupant load not greater than 25 persons; and

2. Three feet 8 inches, if the corridor, passageway or aisle serves a space with an occupant load greater than 25 persons.

(b) The width of a corridor, passageway or aisle which provides egress from an exit shall be at least as wide as the required width for the exit served, as determined under ss. Comm 51.15 (6) and 51.16 (3).

(3) (a) The width of a corridor, passageway, or aisle which provides access to or egress from an exit shall be determined at the narrowest point produced by any projection or other similar object or obstruction.

(b) The required width of a corridor, passageway, or aisle which provides access to or egress from an exit as determined under this section shall be maintained clear and unobstructed at all times.

Note: See ch. Comm 69 for corridor widths to accommodate the physically disabled.

History: 1-2-56; am. Register, December, 1981, No. 312, eff. 1-1-82; r. and recr. Register, March, 1991, No. 423, eff. 4-1-91.

Comm 54.08 Enclosure of stairways and shafts.

(1) (a) Except as provided in par. (b), all stairways including landings, ramps and shafts, shall be enclosed as specified in s. Comm 51.02 (11).

(b) 1. The stairways or shafts connecting one floor level with another floor level immediately adjacent to it may be left unenclosed where the distance to an exit from the area served by the open stairway including the horizontal travel distance on the exit access stair, does not exceed 100 feet in buildings not completely protected by an approved automatic sprinkler system or 150 feet in buildings completely protected by an approved automatic sprinkler system; or

2. Any stairway or shaft connecting the second floor, first floor and basement or ground floor shall be separated at the first floor level or first adjacent basement or ground floor level with fire resistive construction as specified in Table 51.03-A or better in buildings 2 stories or less in height, and where the distance to an exit from the area served by the open stairway including the horizontal travel distance on the exit access stair, does not exceed 100 feet in buildings not completely protected by an approved automatic sprinkler system or 150 feet in buildings completely protected by an approved automatic sprinkler system.

(2) All doors opening into such enclosures shall be as specified in s. Comm 51.047, and all windows shall be of wired glass and metal frames and sash.

Note: See ch. Comm 18 for requirements governing the installation and operation of elevators.

History: 1-2-56; am. (1) (a), (b), (c), (d) and (2), Register, February, 1971, No. 182, eff. 7-1-71; r. and recr. (1) (a), (b), (c), (d) and (2) eff. 8-1-71 and exp. 1-1-72; cr. (1) (a), (b), (c), (d) and (2) eff. 1-1-72, Register, July, 1971, No. 187; r. and recr. (1), Register, June, 1972, No. 198, eff. 1-1-73; am. (3), Register, December, 1977, No. 264, eff. 1-1-78; r. (3), Register, December, 1978, No. 276, eff. 1-1-79; am. (1), Register, January, 1980, No. 289, eff. 2-1-80; am. (1), Register, October, 1982, No. 322, eff. 11-1-82; am. (1) (b), Register, December, 1983, No. 336, eff. 1-1-84; r. and recr. (1) (b) 1., Register, March, 1991, No. 423, eff. 4-1-91.

Comm 54.10 Trap doors and floor openings. Every opening through any floor or through any roof used by the public or by employees shall be guarded by a substantial enclosure or rail not less than 3 feet 6 inches high. Floor openings in buildings of more than 2 stories, unless enclosed with fire-resistive enclosures as specified in s. Comm 54.08 shall be protected by fire-resistive doors as specified in s. Comm 51.047.

History: 1-2-56; am. Register, February, 1971, No. 182, eff. 7-1-71; r. and recr. eff. 8-1-71 and exp. 1-1-72; cr., Register, July, 1971, No. 187, eff. 1-1-72.

Comm 54.105 Toeboards. A toeboard shall be provided at the exposed edges of all elevated platforms, walks, balconies, mezzanines, ramps and floor openings to prevent the fall of materials where the elevation difference is greater than 5 feet. The toeboard shall extend 4 inches above the finished floor. Where material is stockpiled to a height where the toeboard does not provide adequate protection, additional measures shall be taken to prevent the fall of materials.

(1) EXCEPTION. Toeboards are not required on stairways or ramps and their landings or platforms.

History: Cr. Register, December, 1981, No. 312, eff. 1-1-82.

Comm 54.11 Lighting. (1) (a) All stairways, fire escapes and exits, and the passageways leading thereto when used at night, shall be properly illuminated to facilitate egress. The intensity of illumination shall be as specified in ch. Comm 73.

(b) The level of intensity of illumination for fire escapes may be reduced to 2.5 foot candles.

(2) All gas jets or gas lights in factories or workshops where combustible material is used, shall be properly enclosed by globes

or wire cages, or otherwise properly guarded.

History: 1-2-56; am. (1), Register, August, 1985, No. 356, eff. 1-1-86; am. (1) (a), Register, January, 1994, No. 457, eff. 2-1-94; correction made in (1) (a) under s. 13.93 (2m) (b) 7., Stats., Register, December, 1995, No. 480; correction in (1) (a) made under s. 13.93 (2m) (b) 7., Stats., Register, September, 1998, No. 513.

Comm 54.12 Sanitary facilities. (1) GENERAL. The occupancies included under the scope of this chapter shall be provided with toilet rooms as outlined in this section.

(a) The toilet rooms shall be available for all occupants and employees during all hours of operation, except as provided in subs. (2) (b) 4. and (f) 2. b., and shall be located as specified in sub. (2).

(b) Toilet rooms for employees shall be accessible and convenient during all hours of operation.

(c) Sanitary fixtures for the public shall be provided using Table 54.12-A. Sanitary fixtures for employees shall be provided using Table 54.12-B.

Note: Chapter Comm 90 also has requirements for minimum numbers of sanitary fixtures for a public swimming pool, as based on the pool area. For some buildings, the minimum number of sanitary fixtures determined in that manner may be larger than the minimum number determined in accordance with this paragraph. Compliance with this paragraph does not relieve an owner from complying with ch. Comm 90.

TABLE 54.12-A
NUMBER OF SANITARY FIXTURES REQUIRED FOR PATRONS/OCCUPANTS FOR PUBLIC BUILDINGS

Number of Patrons/ Occupants of Each Sex ²	Type of Fixture ¹				
	Water Closets (WC)		Urinals (U)	Drinking Facilities (DF)	Lavatories ³ (L)
	Males (M)	Females (F)			
1-100	1	1	0		
101-200	1	2	1	One (DF) for each 150 occupants or fraction up to 600	One (L) for each 2 fix- tures (WC) or (U) required or fraction
201-250	1	3	2		
251-300	1	4	2		
301-350	2	5	2		
351-400	2	6	2		
401-450	2	7	3		
451-500	2	8	3		
501-600	2	9	4		
Over 600	One (WC) for each additional 600 (M) or 275 (F) or fraction		One (U) for each addi- tional 500 (M) or fraction	One additional (DF) for each additional 3000 occupants or fraction	
Swimming Pools					
1-50	1	2	1	1	1

¹Showers shall be provided for public swimming pool facilities as required by ch. Comm 90, and for occupants exposed to occupational hazards such as poisonous, infectious or irritating materials.

²The determination of the number of each sex shall be based on an equal number of each sex unless other information is made available to the department and accepted. Where a single toilet room designated as UNISEX is provided, it shall be considered as accommodating no more than 10 employees or 25 patrons/occupants. In determining the number of sanitary fixtures, including showers, employees shall be counted as patrons.

³A minimum of one lavatory shall be provided in each toilet room.

Note: For structures with additions or alterations, the required number of sanitary fixtures shall be the sum of the fixtures required for the existing portion at the time it was constructed plus the fixtures required by this table for the new addition or altered area. At such time as the summation of the addition and alteration area is equal to or greater than 51% of the building area calculated as specified in s. Comm 50.03 (4) (d), fixtures shall be provided in conformance to this table utilizing the capacity of the entire building.

Note: See chapter Comm 69 for the percentage and design of accessible drinking facilities.

TABLE 54.12-B
NUMBER OF SANITARY FIXTURES REQUIRED FOR EMPLOYEES FOR PUBLIC BUILDINGS

Number of Employees of Each Sex ²	Type of Fixture ¹			Drinking Facilities (DF)	Lavatories ³ (L)	Showers (S)
	Males (M)	Females (F)	Urinals (U)			
0-15	1	1	0			
16-35	1	2	1	One (DF) for each 100 employees, or fraction	One (L) for each 2 fixtures (WC) or (U), or fraction	One (S) for each 10 employees of each sex, or fraction
36-55	2	3	1			
56-80	2	4	2			
81-110	3	5	2			
111-150	4	6	2			
151-200	5	8	3			
201-250	6	9	3			
Over 250	One (WC) for each additional 55 (M) or fraction; one (WC) for each additional 15 (F) or fraction		One (U) for each additional 75 (M) or fraction			

¹Showers shall be provided in public pool facilities and for employees exposed to occupational hazards such as poisonous, infectious or irritating materials.

²The determination of the number of each sex shall be based on equal number of each sex unless other information is made available to the department and accepted. Where a single toilet room designated as UNISEX is provided, it shall be considered as accommodating no more than 10 employees and 25 occupants.

³A minimum of one lavatory shall be provided in each toilet room.

Note: For structures with additions or alterations, the required number of sanitary fixtures shall be the sum of the fixtures required for the existing portion at the time it was constructed plus the fixtures required by this table for the new addition or altered area. At such time as the summation of the addition and alteration area is equal to or greater than 51% of the building area calculated as specified in s. Comm 50.03 (4) (d), fixtures shall be provided in conformance to this table utilizing the capacity of the entire building.

Note: As illustrated in the following two examples, fixtures must be provided based on the greater number that is determined by comparing occupants and employees against both Tables 54.12-A and 54.12-B. When referring to Table 54.12-A, employees are considered occupants.

Example 1: Mercantile building with 300 patrons and 50 employees = 350 total occupants; equally divided between sexes = 175 males, 175 females. From Table 54.12-A, 101-200 occupants of each sex: males require one water closet, one urinal, one lavatory; females require 2 water closets, one lavatory. Check for compliance with Table 54.12-B for employees: 50 employees, equally divided between sexes = 25 males, 25 females; 16-35 employees of each sex, males require one water closet, one urinal, one lavatory; females require 2 water closets, one lavatory. Therefore, the number of fixtures required by Table 54.12-A also satisfies the requirements of Table 54.12-B for employees and governs.

Example 2: Office building with 300 employees and 50 patrons = 350 total occupants; equally divided between sexes = 175 males, 175 females. From Table 54.12-A, 101-200 occupants of each sex: males require one water closet, one urinal, one lavatory; females require 2 water closets, one lavatory. Check for compliance with Table 54.12-B for employees: 300 employees, equally divided between sexes = 150 males, 150 females; 111-150 employees of each sex, males require 4 water closets, 2 urinals, 3 lavatories; females require 6 water closets, 3 lavatories. Therefore, the number of fixtures required by Table 54.12-B for employees is more restrictive and governs.

Note: See also rules of the department of health and family services for sanitary fixtures for mobile home parks, camping grounds, camping resorts, recreational camps and educational camps.

Note: See chapter Comm 69 for the percentage and design of accessible drinking facilities.

(2) **TOILET ROOMS.** (a) *Factories, office and mercantile buildings.* All factories, office and mercantile buildings shall be provided with separate toilet rooms for each sex.

(b) *Exceptions.* 1. Where not more than 10 employees and 25 patrons are accommodated, one toilet room to accommodate both sexes shall be provided. The door of the toilet room shall be equipped with an operating lock to ensure privacy.

2. Separate toilet rooms for employees and the general public need not be provided if the toilet rooms are accessible to both employees and the general public during all hours of operation. If the toilet rooms are accessible only through the employee work area, separate toilet rooms shall be provided for the general public.

3. Buildings and structures which provide service to people in automobiles, such as drive-in bank teller booths, photography and film service booths, or parking lot attendant booths, but not including drive-in restaurants, shall not be required to provide toilet rooms, provided that a written statement is submitted to the department verifying that convenient toilet facilities are available during all shifts and periods of operation. Toilet rooms are not required for mobile crews or in unattended buildings, provided the employees have access to convenient toilet facilities during all hours of operation.

4. Toilet rooms may be omitted in a small retail or mercantile building where all of the following requirements are met:

- No more than 25 occupants are accommodated.
- Other restrooms are conveniently located and available to the patrons and employees during all hours of operation.
- The omission is approved in writing by the local unit of government.

d. A copy of the written approval from the local unit of government is provided to the department or its authorized representative upon request.

(c) *Shopping centers and shopping malls.* 1. General public. Separate toilet rooms for each sex shall be provided for use by the general public in all shopping centers and shopping malls. The toilet rooms may be located in the public mall or in individual tenant spaces provided the toilet rooms are available during all hours of operation and located as specified in par. (b) 2. A minimum of one set of toilet rooms shall be provided for the general public.

2. Tenant spaces and employees. a. Separate toilet rooms for each sex shall be provided for the employees in each individual tenant space. In tenant spaces which accommodate not more than 10 employees, one toilet room to accommodate both sexes may be provided. For an individual tenant space or an individual booth within the public mall with a net area of 750 square feet or less, toilet rooms for the employees need not be provided if the employees have access to convenient public toilet rooms located in the public mall during all hours of operation.

b. Toilet rooms for other use groups which may also be included in shopping centers or shopping malls shall be provided as specified in sub. (2) (e) and s. Comm 55.32.

Note: The department recommends that public toilet rooms in shopping centers and shopping malls be conveniently located for patron use and that the travel distance between sets of public toilet rooms be less than 400 feet. A set of public toilet rooms means one toilet room for each sex.

(d) *Places of worship and mausoleums.* 1. Places of worship. Places of worship which are included under this chapter shall be provided with separate toilet rooms for each sex.

2. Mausoleums. Sanitary facilities are not required for unheated worship areas of mausoleums without fixed seating or for mausoleums within cemeteries where public sanitary facilities for each sex are provided within the cemetery.

(e) *Places for entertainment, recreation and dining.* 1. Restaurants, taverns, and places for entertainment and recreation which are included under the scope of this chapter shall be pro-

vided with separate toilet rooms for each sex. Separate toilet rooms for employees and the general public need not be provided if the toilet rooms are accessible to both employees and the general public during all hours of operation.

2. For mixed-use facilities, such as a dinner theater, the number required for the restaurants apply.

Note: See rules of the department of health and family services, ch. HFS 196—Restaurants, for supplementary requirements for toilet room facilities in restaurants.

(f) *Garages, service stations and filling stations.* Toilet rooms shall be provided as outlined in this paragraph.

1. Garages. Separate toilet rooms for each sex shall be provided in all service and repair garages, body shops, automobile tire and battery shops, and buildings of similar use, except that a single toilet room to accommodate both sexes may be provided in buildings which accommodate not more than 10 employees and 25 patrons. If toilet rooms are accessible to both employees and patrons during all hours of operation, separate toilet rooms for employees and patrons need not be provided.

2. a. Service stations and filling stations. Separate toilet rooms for each sex shall be provided in service stations and filling stations, including self-service stations. If toilet rooms are accessible to both employees and patrons, separate toilet rooms for employees and patrons need not be provided.

b. A self-service filling station that has a key- or card-operated fuel dispensing device which can be used while the station is unattended by an employee is not required to have toilet rooms available during the unattended periods.

(g) *Airports, bus terminals, train stations and other transportation centers.* All airports, bus terminals, train stations and other transportation centers shall be provided with separate toilet rooms for each sex as required in Table 54.12-A.

(3) **SANITARY FIXTURES.** (a) *General.* In public buildings and places of employment, except as provided in par. (b), the total number of sanitary fixtures required in the building shall be based upon the total number of occupants of the building and shall be determined by using the higher number calculated from Tables 54.12-A and 54.12-B. The total number of occupants will be considered equally divided between males and females unless a different ratio is established by the department.

(b) *Exceptions.* 1. Except as provided in subd. 2., taverns and restaurants shall provide at least one separate toilet room for each sex.

2. Restaurants providing seating for 15 or less occupants, one toilet room having at least one water closet (WC) and one lavatory (L) may be provided to accommodate both sexes. The door of the toilet room shall be equipped with a lock to ensure privacy. If the toilet rooms are accessible to both employees and the general public, separate toilet rooms for employees and the general public need not be provided.

3. Taverns and restaurants accommodating 16 to 50 total occupants, at least one water closet (WC) and one lavatory (L) for each sex shall be provided.

4. Taverns and restaurants accommodating 51 to 100 occupants, at least 2 water closets (WC) and one lavatory (L) for female patrons and at least one water closet (WC), one urinal (U) and one lavatory (L) for male patrons shall be provided.

5. Taverns and restaurants accommodating more than 100 occupants, the number of sanitary fixtures provided shall be as determined by using Table 55.32.

(c) *OSHA regulations.* The ratios for water closets established in Table 54.12-B for employees are taken directly from the U.S. department of labor, occupational safety and health act (OSHA) regulations. Therefore, s. Comm 50.25, petitions for variance, is not applicable to the requirements of Table 54.12-B.

History: 1-2-56; am. (3) (a) and (b), and (6), Register, September, 1959, No. 45, eff. 10-1-59; r. and recr. Register, December, 1976, No. 252, eff. 1-1-77; am. (1) (a) 1., (1) (b) and (e) 1., r. (1) (c) 3., r. and recr. (2), Register, December, 1977, No. 264, eff. 1-1-78; am. (2) (intro.) and (2) (a) 2., Register, December, 1978, No. 276, eff. 1-1-79; r. and recr. table and (2) (a) 1., Register, December, 1981, No. 312, eff.

1-1-82; r. and recr. (2) (a) 1., Register, October, 1982, No. 322, eff. 11-1-82; am. (1) (a) 1. and (c) 1., Register, December, 1983, No. 336, eff. 1-1-84; am. table 54.12 A and B, r. (2) (a) 1. a., renum. (2) (a) 1. intro., b. and c. to be a. d. and e. and am. a., cr. (2) (a) 1. b. and c., Register, August, 1985, No. 356, eff. 1-1-86; am. (2) (a) 1. c. and d., r. (2) (a) 2., Register, March, 1991, No. 423, eff. 4-1-91; r. and recr. (1) (c), Register, March, 1992, No. 435, eff. 4-1-92; r. and recr. Register, August, 1993, No. 452, eff. 3-1-94; correction in (3) (c) made under s. 13.93 (2m) (b) 7., Stats., Register, September, 1998, No. 513; am. (1) (a) and Table 54.12-A, cr. (2) (b) 4. and (f) 2. b., renum. (2) (f) 2. to be (2) (f) 2. a., Register, September, 2000, No. 537, eff. 10-1-00.

Comm 54.13 Change rooms and lunchrooms.

(1) **CHANGE ROOMS.** Change rooms equipped with storage facilities for street clothes shall be provided where employees are required to wear protective clothing due to the nature of the employment and where employees are exposed to toxic materials and industrial poisons. Separate storage facilities for street clothes and work clothes shall be provided for employees who work with industrial poisons.

Note: See also ch. HFS 196, Wis. Adm. Code, rules of the department of health and family services, for requirements for dressing rooms and lockers in restaurants.

(2) **LUNCHROOMS.** A space for eating lunches shall be provided in all places of employment where there is exposure to injurious dusts, toxic material and industrial poisons. Such space shall be physically separate from any location where there is exposure to toxic materials. Toilet rooms shall not be permitted to serve as lunchrooms.

History: Cr. Register, December, 1976, No. 252, eff. 1-1-77.

Comm 54.145 Occupancy separations and hazard enclosures. Occupancies within the scope of this chapter shall be separated from other occupancies or uses in accordance with s. Comm 51.08. Hazards shall be enclosed in accordance with s. Comm 51.08.

History: Cr. Register, December, 1981, No. 312, eff. 1-1-82; r. and recr. Register, March, 1991, No. 423, eff. 4-1-91; r. and recr. Register, December, 1995, No. 480, eff. 4-1-96; r. and recr. Register, March, 1997, No. 495, eff. 4-1-97.

Comm 54.15 Fire protection systems. (1) **SPRINKLER SYSTEMS.** Automatic fire sprinkler systems shall be provided as outlined in ss. Comm 52.01, 52.011, 52.012 and 52.013.

(2) **STANDPIPE SYSTEMS.** (a) *Fire department standpipes.* Fire department standpipes shall be provided in all buildings exceeding 60 feet in height.

(b) *Dry standpipes.* Dry standpipes as specified under s. Comm 51.21 shall be provided in all buildings 3 stories or more in height in which the floor area of each story is more than 3,000 square feet, unless an approved automatic sprinkler system is installed. First-aid standpipes may be provided in lieu of dry standpipes in factory occupancies.

(3) **FIRE EXTINGUISHERS.** Portable fire extinguishers shall be provided and maintained as specified in s. Comm 51.22.

History: 1-2-56; renum. from 54.14 and r. and recr. Register, December, 1976, No. 252, eff. 1-1-77; am. (2), Register, December, 1977, No. 264, eff. 1-1-78; emerg. r. and recr. (2), eff. 9-6-86; r. and recr. (2), Register, November, 1986, No. 371, eff. 12-1-86; r. and recr. Register, March, 1991, No. 423, eff. 4-1-91; am. (2) (b), Register, January, 1994, No. 457, eff. 2-1-94; correction in (1) made under s. 13.93 (2m) (b) 7., Stats., Register, September, 1998, No. 513.

Comm 54.17 Fire alarms. (1) **FACTORY AND WORKSHOP.** Except as provided in sub. (3), a manual fire alarm complying with the requirements of s. Comm 51.24 shall be provided in every factory or workshop where more than 10 persons are employed above the second story.

(2) **OFFICE BUILDINGS.** Except as provided in sub. (3), a manual fire alarm complying with the requirements of s. Comm 51.24 shall be provided in office buildings complying with either of the following conditions:

(a) Four stories or more in height; or

(b) 15,000 square feet or more on any floor level above or below a floor of exit discharge.

(3) **EXCEPTION.** The installation of a manual fire alarm system may be omitted in buildings where complete automatic fire sprinkler system protection is provided.

History: 1-2-56; am. Register, June, 1972, No. 198, eff. 1-1-73; renum. from 54.16, Register, December, 1976, No. 252, eff. 1-1-77; r. and recr. Register, Decem-

ber, 1981, No. 312, eff. 1-1-82; emerg. r. and recr., eff. 9-6-86; r. and recr. Register, November, 1986, No. 371, eff. 12-1-86.

Comm 54.18 Floor load signs. (1) In every factory, workshop, warehouse, or other building where material is piled, notices of a permanent character shall be painted or otherwise prominently displayed, stating the live load in pounds per square foot which the floor is designed to carry. Such notices shall be placed in full view, on each floor.

(2) Where floors are always used for the storage of some particular material, the walls shall be marked to the height to which the material shall be piled without exceeding the safe load.

History: 1-2-56; renum. from 54.17, Register, December, 1976, No. 252, eff. 1-1-77.

Comm 54.19 Signs indicating number of persons.

In all buildings of this classification where 50 or more persons are accommodated on any floor above the second, notices shall be prominently displayed stating the maximum number of persons

on each floor for whom stairways and other exits have been provided according to ss. Comm 54.02 to 54.06. Such notices shall be placed in full view, on each floor.

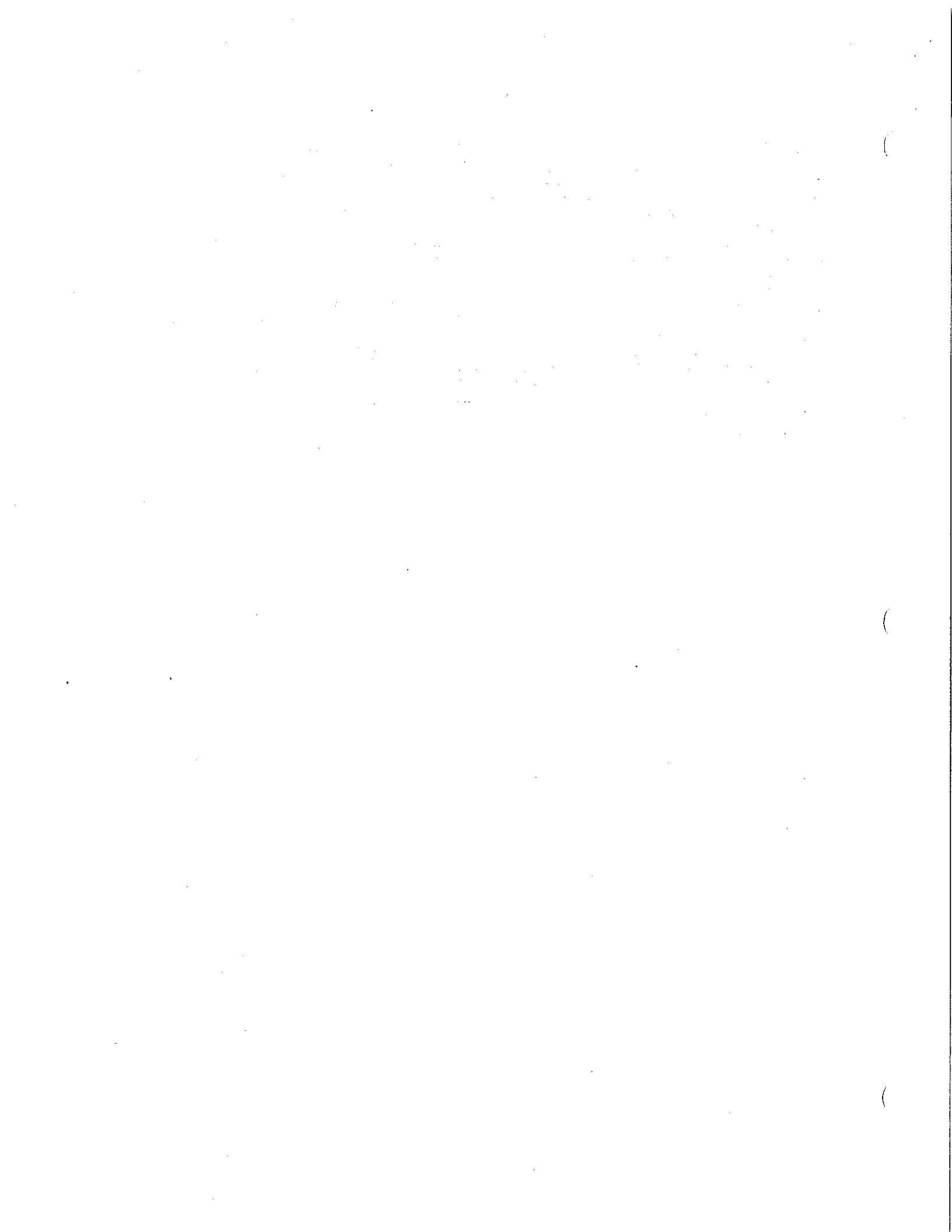
History: 1-2-56; renum. from 54.18, Register, December, 1976, No. 252, eff. 1-1-77.

Comm 54.20 No smoking signs. Smoking shall not be permitted in retail establishments where flammable materials are handled or sold. Suitable signs bearing the words "No Smoking" shall be erected in all places where such hazard exists.

History: 1-2-56; renum. from 54.19, Register, December, 1976, No. 252, eff. 1-1-77.

Comm 54.21 Tents. All tents used for sales or storage purposes shall conform to the requirements specified in ss. Comm 62.42 to 62.51.

History: Cr. Register, September, 1959, No. 45, eff. 10-1-59; renum. from 54.20, Register, December, 1976, No. 252, eff. 1-1-77; am. Register, December, 1981, No. 312, eff. 1-1-82; correction made under s. 13.93 (2m) (b) 7., Register, September, 1998, No. 513.



Chapter Comm 55

THEATERS AND ASSEMBLY HALLS

Comm 55.001	Scope.	Comm 55.23	Proscenium curtain.
Comm 55.01	Definitions.	Comm 55.24	Automatic smoke outlet.
Comm 55.02	Class of construction.	Comm 55.25	Stage vestibules.
Comm 55.03	Height above grade.	Comm 55.26	Footlight trough.
Comm 55.04	Exposure and courts.	Comm 55.27	Fireproof paint.
Comm 55.05	Occupancy separations and hazard enclosures.	Comm 55.28	Stage accessory rooms.
Comm 55.06	Capacity.	Comm 55.30	Lights and lighting.
Comm 55.07	Number and location of exits.	Comm 55.32	Sanitary facilities.
Comm 55.08	Type of exits.	Comm 55.33	Fire protection systems.
Comm 55.09	Stairways and shafts.	Comm 55.39	Use of "safety-base" film.
Comm 55.10	Exit doors and doorways.	Comm 55.40	Motion picture machine booths, general.
Comm 55.11	Exit lights.	Comm 55.41	Construction of booth.
Comm 55.12	Required exit width.	Comm 55.42	Doors.
Comm 55.13	Seating.	Comm 55.43	Openings.
Comm 55.14	Width of aisles.	Comm 55.44	Ventilation of booths.
Comm 55.15	Lobbies and foyers.	Comm 55.45	Relief outlets.
Comm 55.16	Inclines and aisle steps.	Comm 55.46	Electric wiring.
Comm 55.17	Obstruction.	Comm 55.47	Motion picture machine.
Comm 55.18	Mirrors and false openings.	Comm 55.48	Fire protection in booth; care and use of film.
Comm 55.19	Decorations.	Comm 55.49	Portable booths.
Comm 55.21	Stage separation.	Comm 55.50	Maintenance.
Comm 55.22	Proscenium wall.		

Note: Chapter Ind 55 was renumbered to be chapter ILHR 55 effective January 1, 1984. Corrections made under s. 13.93 (2m) (b) 7., Stats., Register, March, 1997, No. 495. Chapter ILHR 55 was renumbered to be chapter Comm 55 under s. 13.93 (2m) (b) 1. and corrections were made under s. 13.93 (2m) (b) 7., Stats., Register, December, 1997, No. 504.

Comm 55.001 Scope. The requirements of this chapter shall apply to all theatres and assembly halls.

Note: For assembly areas in connection with schools and other places of instruction, refer to ch. Comm 56.

History: 1-2-56; r. and recr. Register, August, 1985, No. 356, eff. 1-1-86.

Comm 55.01 Definitions. In this chapter:

(1) "Assembly halls" or "places of assembly" mean all buildings, or parts of buildings, other than theaters, which will accommodate more than 100 persons for entertainment, recreation, wor-

ship or dining purposes.

Note: Assembly halls or places of assembly which will accommodate not more than 100 persons are included within the scope of ch. Comm 54.

(2) "Theaters" means all buildings or parts of buildings, containing an assembly hall, having a stage which may be equipped with curtains or permanent or movable scenery, or which is otherwise adaptable to the showing of plays, operas, motion pictures or similar forms of entertainment.

History: 1-2-56; am. (1) (intro. par.), Register, March, 1972, No. 195, eff. 4-1-72; am. (1)(a), Register, January, 1980, No. 289, eff. 2-1-80; r. and recr. Register, August, 1985, No. 356, eff. 1-1-86.

Comm 55.02 Class of construction. (1) **GENERAL.** The capacities of buildings or parts of buildings in this classification for the various types of construction shall not exceed, and shall comply with, the following requirements:

MAXIMUM CAPACITIES

Class of Construction	Without Complete Automatic Fire Sprinkler System Protection		With Complete Automatic Fire Sprinkler System Protection	
	With Stage	Without Stage	With Stage	Without Stage
Type 1 and 2	No limit	No limit	No limit	No limit
Type 3 and 4	750	1,500	1,000	2,000
Type 5 and 6	500	1,000	750	1,500
Type 7 and 8	300	750	500	1,000

(2) **UNLIMITED CAPACITY BUILDINGS.** Buildings of type 3, 5 or 6 totally noncombustible construction, or type 4 construction, may have unlimited capacities provided:

(a) The building does not exceed one story in height;

(b) The floor framing and its supports for any mezzanine is constructed of noncombustible materials with at least a one-hour fire resistive rating; and

(c) Any basement or ground floor is:

1. Separated from any upper floor level by noncombustible construction with at least a 4-hour fire resistive rating; and

2. Used only to accommodate mechanical equipment.

(2m) **TYPE 7 AND 8 CONSTRUCTION.** (See s. Comm 51.03.) Where buildings of these classifications are erected of type 7 or 8 construction, the following restrictions shall apply:

(a) Located at least 20 feet from any other building or adjoining property line, except for those buildings as permitted under par. (c) 4.;

(b) Is not built in connection with a building used for any other purpose, unless the assembly hall is separated from the other building by a fire division wall as specified in s. Comm 51.02 (13); and

(c) Except as provided in subs. 1. to 5., not more than one story in height and limited to one floor level.

1. Exception. A basement or ground floor heating and fuel room enclosed with fire-resistive construction as specified in s. Comm 51.08 (2) and Table 51.08-2, with all interior openings protected with self-closing fire-resistive door assemblies as specified in s. Comm 51.047 will be permitted.

2. Exception. A place of worship may have:

a. A full basement or ground floor; and

b. A balcony or mezzanine which has at least one side open to the floor below and which has a maximum occupancy of 30 persons.

3. Exception. One-story and ground-floor assembly halls of type 7 or 8 construction will be permitted providing the following conditions are satisfied:

a. Both levels shall exit directly to grade. One exit stair from the lower level up to the exit discharge grade is permitted providing the stair is enclosed to the outside by 2-hour fire-resistive rated construction;

b. The ground story exterior walls shall be of masonry or concrete;

c. The lower level shall be separated from the upper level by 2-hour noncombustible fire-resistive rated construction or better. The first floor supports shall also be of 2-hour noncombustible fire-resistive rated construction;

d. All stairways shall be enclosed by at least 2-hour fire-resistive rated enclosures;

e. The maximum capacity of the building is limited as specified in sub. (1); and

f. All other requirements of ch. Comm 55 are satisfied.

4. Exception. Additions to existing buildings of type 7 or 8 construction having a basement or second floor, or both, will be permitted under the scope of ch. Comm 54 providing the following conditions are satisfied:

a. The building contains no other occupancy except the owner's private residence;

b. Public occupancy is prohibited in the basement and second floor;

c. The addition does not contain a basement, second floor or ground floor;

d. The public occupancy areas are divided by partitions, dividers and similar objects into definable areas having a maximum capacity of 100 occupants each. Each definable area shall have 2 independent, remote exits to the outside;

e. The maximum capacity of the building is limited as specified in sub. (1);

f. All other requirements of ch. Comm 54 are satisfied; and

g. This exception does not apply to buildings originally constructed within 5 years of submissions of plans for the addition.

5. Exception. Buildings completely protected by automatic fire sprinkler system protection may not exceed 2 stories in height and shall be limited to 2 floor levels.

(3) **BALCONIES ACCOMMODATING MORE THAN 100.** In any theater or assembly hall, balconies which accommodate more than 100 persons shall be type 1 or 2 construction as specified in s. Comm 51.03.

History: 1-2-56;(1); (1) (a); (2); (2) (a); (2) (b); (2) (c); (2) (d); (2) (e); (2) (f); (3); am. Register, June, 1956; No. 6, eff. 7-1-56; am. (1) (a), Register, August, 1957, No. 20, eff. 9-1-57; am. Register, January, 1961, No. 61, eff. 2-1-61; am. (2) (a), Register, February, 1971, No. 182, eff. 7-1-71; r. and recr. (2) (a) eff. 8-1-71 and exp. 1-1-72; cr. (2) (a) eff. 1-1-72, Register, July, 1971, No. 187; r. and recr. (1), am. (2) intro. par., and (3), Register, June, 1972, No. 198, eff. 1-1-73; cr. (1) (a), Register, September, 1973, No. 213, eff. 10-1-73; am. (2) (a), Register, May, 1974, No. 221, eff. 6-1-74; am. (1) (a), Register, July, 1974, No. 223, eff. 8-1-74; r. (2) (d) and (e), Register, December, 1977, No. 264, eff. 1-1-78; am. (1) (a), cr. (2) (a) 1. to 3., Register, December, 1978, No. 276, eff. 1-1-79; am. (2) (a) 2.c., Register, January, 1980, No. 289, eff. 2-1-80; am. (2) (a) 3. c., Register, December, 1981, No. 312, eff. 1-1-82; reprinted to correct error in (2) (a) 1., Register, February, 1982, No. 314; renum. (2) (a) 1. to 3., (b) and (c) to be (2) (c) 2. to 4., (a) and (b), r. (2) (a) (intro.) and cr. (2) (c) (intro.) and 1., Register, August, 1985, No. 356, eff. 1-1-86; emerg.

r. and recr. (1) and (2) (a) and (b), am. (2) (c) (intro.), 3. e. and 4. c., cr. (2) (c) 5., eff. 9-6-86; r. and recr. (1) renum. (2) to be (2m) and am. (c) (intro.), 3. e. and 4. c., cr. (c) 5., Register, November, 1986, No. 371, eff. 12-1-86; reprinted to restore dropped copy, Register, December, 1986, No. 372; r. recr. (2) and (2m) (c) 2., am. (2m) (a) and (b), Register, March, 1991, No. 423, eff. 4-1-91; am. (2) (intro.), Register, January, 1994, No. 457, eff. 2-1-94; correction in (2m) (c) made under s. 13.93 (2m) (b) 7., Stats., Register, December, 1997, No. 504.

Comm 55.03 Height above grade. The height of the sills of the principal entrance doors to any theater, as defined in s. Comm 55.001, shall be not more than 18 inches above the outside grade at that point. The floor level at the highest row of seats on the main floor shall not be more than 6 feet above the outside grade at the main entrance; the floor level at the lowest row of seats on the main floor shall be not more than 6 feet below, or above, the grade at the nearest exit.

History: 1-2-56; r. and recr. Register, September, 1959, No. 45, eff. 10-1-59; am. (2) and (3), Register, June, 1972, No. 198, eff. 1-1-73; am. (2), Register, September, 1973, No. 213, eff. 10-1-73; r. (2) and (3), renum. (1) to be ILHR 55.03, Register, March, 1991, No. 423, eff. 4-1-91.

Comm 55.04 Exposure and courts. (1) Every theater or assembly hall which accommodates more than 600 persons shall have at least 3 walls abutting on streets, alleys, or open courts.

(2) The wall containing the main entrance to any theater or assembly hall shall abut on a street. The lobby or passageway leading from the main entrance doors to the foyer or auditorium shall be direct and unobstructed and of a minimum width equal to the sum of the widths of the main entrance doors. There shall be no openings from other occupancies to such a corridor or passageway.

(3) The width of every exit court shall be at least 6 feet for an occupancy not exceeding 500 persons, and shall be increased at the rate of one foot per each 500 persons additional. Every such court shall lead to a public thoroughfare, either directly, or through a passageway of equal width, not less than 8 feet high enclosed with unpierced 4-hour fire-resistive walls, ceiling and floor as specified in s. Comm 51.04. The floor and ceiling shall be designed for a live load of not less than 150 pounds per square foot. No such court, or passageway shall be used for storage or any other purpose whatsoever.

History: 1-2-56; am. (3), Register, February, 1971, No. 182, eff. 7-1-71; r. and recr. (3) eff. 8-1-71 and exp. 1-1-72; cr. (3) eff. 1-1-72, Register, July, 1971, No. 187.

Comm 55.05 Occupancy separations and hazard enclosures. Occupancies within the scope of this chapter shall be separated from other occupancies or uses in accordance with s. Comm 51.08. Hazards shall be enclosed in accordance with s. Comm 51.08.

History: 1-2-56; am. Register, January, 1961, No. 61, eff. 2-1-61; am. (3), Register, February, 1971, No. 182, eff. 7-1-71; r. and recr. (3) eff. 8-1-71 and exp. 1-1-72; cr. (3) eff. 1-1-72, Register, July, 1971, No. 187; am. (2), Register, June, 1972, No. 198, eff. 1-1-73; cr. (4), Register, December, 1978, No. 276, eff. 1-1-79; am. (1) and (3), cr. (5), Register, December, 1981, No. 312, eff. 1-1-82; r. and recr. Register, March, 1991, No. 423, eff. 4-1-91; r. and recr., Register, December, 1995, No. 480, eff. 4-1-96; r. and recr. Register, March, 1997, No. 495, eff. 4-1-97.

Comm 55.06 Capacity. (1) Table 55.06 includes the various types of occupancy within the scope of this section, together with the method to be used in determining the capacity.

(2) No greater number of persons than the number thus established shall be permitted in any theater or assembly hall.

**TABLE 55.06
OCCUPANCY CAPACITY**

Use or Occupancy	Basis of Capacity
(a) Arenas and field houses . . .	4 sq. ft. per person. Use seated areas only.
(b) Assembly halls, with stage .	7 sq. ft. per person.
(c) Banquet halls	10 sq. ft. per person.
(d) Churches (auditoriums) . . .	7 sq. ft. per person.
(e) Churches (dining rooms) . .	10 sq. ft. per person.
(f) Dance halls	10 sq. ft. per person.
(g) Dining rooms	10 sq. ft. per person.
(h) Gymnasiums	6 sq. ft. per person for seated space. 15 sq. ft. per person for unseated space.
(i) Lecture halls	7 sq. ft. per person.
(j) Lodge halls	6 sq. ft. per person for seated space. 15 sq. ft. per person for unseated space.
(k) Skating rinks	45 sq. ft. per person.
(L) Theaters	7 sq. ft. per person.
(m) Theater lobbies	7 sq. ft. per person.
(n) Swimming pool rooms	10 sq. ft. per person for deck area

(3) The capacity of theaters and theater lobbies must be combined to determine the theater capacity.

(4) (a) Every theater or assembly hall having movable seats shall display a sign stating the maximum number of persons permitted by code.

1. The sign shall be placed in a conspicuous place at the main entrance to each theater or assembly hall.

2. The sign shall have the following wording: "Limit (Number) Persons." The maximum number of persons shall be determined by the capacity as permitted by sub. (2) and s. Comm 55.12. The lettering shall be white on a dark background. The letters shall be not less than 1½ inches in height and the number shall be not less than 3 inches in height.

History: 1-2-56; cr. (4) (a), Register, July, 1966, No. 127, eff. 8-1-66; r. (2) (k), renum. (2) (l) (m) (n) to be (k) (l) and (m), Register, September, 1973, No. 213, eff. 10-1-73; am. (2) (k), Register, December, 1981, No. 312, eff. 1-1-82; am. (1), cr. (2) (n), Register, January, 1994, No. 457, eff. 2-1-94.

Comm 55.07 Number and location of exits. (1) (a) Except as provided in par. (b), every floor and balcony of a theater and assembly hall shall be provided with not less than 2 exits, placed as far apart as practicable and so located that if any exit is blocked, some other exit will still be available from every part.

(b) A balcony accommodating not more than 30 persons in places of worship may be served by one exit.

(2) Where more than 600 persons are accommodated, there shall be at least 3 exits and where more than 1,000 persons are accommodated, there shall be at least 4 exits.

(3) Exits shall be distributed on all sides which adjoin streets, alleys or open courts.

History: 1-2-56; r. and recr. (1), Register, August, 1985, No. 356, eff. 1-1-86.

Comm 55.08 Type of exits. (1) The required exits from any part of a theater or assembly hall shall be exit doorways, stairways or ramps.

(2) All exits to grade from a higher or lower level shall be stairways or approved ramps. In all theaters and in assembly halls having a capacity of more than 400 persons, where the exit rise is not more than 3 feet approved ramps shall be used. By approved ramp is meant an incline located inside the building and having a slope of not more than one foot of rise in 8 feet.

(3) Stairway exits shall be interior stairways, or smokeproof towers as specified in s. Comm 51.17; except that "B" type fire escapes may be used as exits from balconies for not more than one-half the required exit width, if located against blank walls.

(4) All ramps for barrier-free public access to a building, including nonrequired ramps, shall be inside the building.

(5) Exterior stairs may be used as required exits from exterior decks, for seasonal recreational facilities.

History: 1-2-56; cr. (4) and (5), Register, January, 1994, No. 457, eff. 2-1-94.

Comm 55.09 Stairways and shafts. (1) Every stairway in a theater or assembly hall shall be enclosed as specified in s. Comm 51.18 with the following exceptions:

(a) Monumental stairways from the main floor to the first balcony need not be enclosed provided the balcony is served by additional enclosed stairways as specified in ss. Comm 51.02 (11) and 55.07.

(b) 1. In a place of worship, a monumental exit access stairway from the main floor to the first balcony having an occupant load of not more than 30 persons need not be enclosed.

2. In a place of worship, a monumental exit access stairway from the main floor to the first balcony having an occupant load of 31 to 100 persons need not be enclosed provided the balcony is served by an additional open stairway.

3. In a place of worship, stairways from the main floor to the first balcony having an occupant load greater than 100 persons shall be enclosed to the outside as specified in ss. Comm 51.02 (11) and 51.18.

4. Stairways from the basement to the first floor of a single story place of worship need not be enclosed if they lead directly to the exits.

(2) Stairways and steps which have more than 3 risers shall have handrails on both sides.

(3) Less than 3 risers may be used to elevated altars, podiums and similar areas in churches provided the elevated area is not part of a required exit passageway.

(4) Except as provided in sub. (1), stairways, shafts and other vertical openings shall be enclosed as specified in s. Comm 51.02 (11).

Note: See s. Comm 51.16 for general stairway requirements.

History: 1-2-56; am. Register, January, 1961, No. 61, eff. 2-1-61; r. and recr. Register, February, 1968, No. 146, eff. 3-1-68; am. (4), Register, February, 1971, No. 182, eff. 7-1-71; am. (2), Register, December, 1974, No. 228, eff. 1-1-75; am. (1) (intro.) and cr. (4) (a), Register, December, 1978, No. 276, eff. 1-1-79; am. (1) (a), Register, December, 1981, No. 312, eff. 1-1-82; r. and recr. (1) (b), Register, October, 1982, No. 322, eff. 11-1-82; r. (2), renum. (3) and (4) to be (2) and (3) and am. (3) Register, August, 1985, No. 356, eff. 1-1-86; r. (3) (a), renum. (3) (b) to be (3), Register, January, 1994, No. 457, eff. 2-1-94; cr. (4), Register, March, 2000, No. 531, eff. 4-1-00.

Comm 55.10 Exit doors and doorways. (1) Every required single exit doorway shall contain a standard exit door as specified in s. Comm 51.15, except:

(a) No single door or leaf of a double door may be more than 3 feet 6 inches wide and multiple door panels may not be hinged together; and

(b) Rolling, sliding and overhead types of doors or gates may be used as standard exit doors for tenant spaces in malls provided:

1. The door or gate is equipped with exit hardware in accordance with s. Comm 51.15 (3);

2. The door or gate is counterbalanced such that it can be opened by a force not exceeding 12 pounds, or, if the door or gate is electrically operated, the door is supplied by an emergency power source capable of opening the door or gate;

3. The door or gate is maintained in a fully opened position during the business hours of the tenant space;

4. A security device permitted by s. Comm 51.15 (3) (e) 2. is not engaged when the tenant space is occupied; and

5. Manual, chain hoist operators for the doors or gates are not employed.

(2) Sills at all exit doorways shall be level and flush with adjacent inside and outside floors and ramps. Where an aisle or passageway leads to an exit from either side of the exit doorway there shall be a level floor space at the doorway extending the width of the aisle and the doorway.

History: 1-2-56; am. (4), Register, August, 1985, No. 356, eff. 1-1-86; r. and recr. Register, March, 1991, No. 423, eff. 4-1-91; r. and recr. (1) (a), r. (1) (b), renun. (1) (c) to be (1) (b), Register, January, 1994, No. 457, eff. 2-1-94.

Comm 55.11 Exit lights. All required exits, except those in church auditoriums, shall be identified by an approved exit light. Directional exit lights shall be provided to direct occupants to the exits. Exit lights and directional exit lights shall be as specified in s. Comm 51.15 (5).

History: 1-2-56; r. and recr. Register, December, 1983, No. 336, eff. 1-1-84.

Comm 55.12 Required exit width. (1) The total required exit width from a building level shall be in accordance with the requirements of ss. Comm 51.15 (6) and 51.16(3).

(2) In theaters, the width of the front entrance shall be not less than 1/3 of the total required exit width.

History: 1-2-56; am. (1), Register, June, 1972, No. 198, eff. 1-1-73; am. (1), Register, December, 1974, No. 228, eff. 1-1-75.

Comm 55.13 Seating. All chairs, seats and benches used for the purpose of assembly seating shall conform to the requirements of subch. V of ch. Comm 62.

History: 1-2-56; am. Register, January, 1961, No. 61, eff. 2-1-61; r. (2), renun. (3) to (6) to be (2) to (5), Register, January, 1980, No. 289, eff. 2-1-80; r. and recr. Register, December, 1981, No. 312, eff. 1-1-82.

Comm 55.14 Width of aisles. (1) Aisles having seats on both sides shall not be less than 2 feet 10 inches wide at the beginning and shall increase in width toward the exits at the rate of 1/4 inch per foot of run; or the aisle may have a uniform width not less than the average width of the foregoing calculation. No wall aisle shall be less than 3 feet wide and no other straight aisle shall be less than 3 feet 6 inches wide.

(2) There shall be a cross aisle leading to each required side exit. Cross aisles shall not be less than 6 feet 8 inches back to back of adjacent rows of seats.

Comm 55.15 Lobbies and foyers. The width of lobbies and foyers shall be determined on the same basis as required for exits in s. Comm 55.12, but shall in no case be less than 5 feet wide, and shall be so designed and apportioned as to prevent congestion and confusion. Lobbies and foyers which serve as means of egress shall be at least equal in combined width to the required width of the stairways, passageways, aisles or exit doorways leading to them.

Comm 55.16 Inclines and aisle steps. (1) To overcome any difference in level between courts, corridors, lobbies, passageways or aisles required, or used, in egress from a theater or an assembly hall, approved ramps as specified in s. Comm 55.08 shall be employed where the difference in elevation does not exceed 3 feet, except that this requirement need not apply to balconies.

(2) Steps in balcony aisles shall extend the full width of the aisle and shall have a uniform rise and run as specified in s. Comm 55.09. No handrails will be required.

Comm 55.17 Obstruction. (1) All lobbies, aisles, passageways and doorways shall be kept free from furniture, drapes, display equipment, merchandise, vending machines and other obstructions, and no person except an employee shall be allowed

to stand in or occupy, any of the aisles, passageways, corridors or lobbies during any performance or public gathering. Except that patrons may be allowed to wait in a lobby or similar space if such use does not encroach upon the required clear width of the exits. Such waiting shall be restricted to areas separated from the required exit ways by fixed railings not less than 42 inches high. In entrance lobbies only, the exit space may be divided by railings not less than 36 inches high set up in the direction of travel in an approved manner for the regulation of ingress and egress.

(2) A booth or counter for the sale of package merchandise may be placed in the lobby or foyer of a theater where there is sufficient excess space so that the front of the booth or counter can be located not less than 5 feet back of the line marking the width of the lobby or foyer required for exit purposes.

Comm 55.18 Mirrors and false openings. (1) No mirror shall be placed in any part of a theater or assembly hall used by the public for exit purposes, including lobbies, corridors, stairways, ramps or any other exit facility. Where a mirror is used in an auditorium, it shall be placed flush with the wall and with the bottom at least 7 feet above any floor, balcony, gallery or platform.

(2) No false opening or decorative device giving the appearance of a door or window, where none exists, shall be placed in any part of a theater or assembly hall used by the public.

Comm 55.19 Decorations. Fabric decorations used in theaters and assembly halls shall be flame proof.

Comm 55.21 Stage separation. (1) In every theater and assembly hall the stage shall be completely separated from the auditorium by a proscenium wall of 4-hour fire-resistive construction as specified in s. Comm 51.04, except as follows:

(a) In theaters and assembly halls having a capacity not exceeding 500 persons, the proscenium wall shall be of 2-hour fire-resistive construction as specified in s. Comm 51.04, or better.

(b) In theaters and assembly halls an open stage or platform will be permitted without the proscenium wall separation from the auditorium, provided the stage or platform is not more than 6 feet higher or wider than the proscenium opening.

History: 1-2-56; am. (1) intro par., and (1) (a), Register, February, 1971, No. 182, eff. 7-1-71; r. and recr. (1) intro. para. and (a), eff. 8-1-71 and exp. 1-1-72, and cr. (1) intro. par. and (a), eff. 1-1-72, Register, July, 1971, No. 187.

Comm 55.22 Proscenium wall. (1) The proscenium wall shall extend from an incombustible foundation, or from the lowest fireproof floor below the stage floor, to the highest adjoining roof, except that where a 4-hour fire-resistive wall is required it shall extend at least 2 feet above the highest adjoining roof.

(2) There shall be not more than 2 openings in the proscenium wall below the level of the auditorium floor, and not more than 2 openings other than the proscenium opening, in the proscenium wall above the level of the auditorium floor, except that in addition to the above openings there may be one opening to provide access through the proscenium wall to the orchestra pit.

(3) Each such opening shall be protected by fire-resistive door assemblies as specified in s. Comm 51.047.

History: 1-2-56; am. (3), Register, March, 1972, No. 195, eff. 4-1-72; am. (3), Register, August, 1985, No. 356, eff. 1-1-86.

Comm 55.23 Proscenium curtain. Where a proscenium wall is required for the separation of a stage from an auditorium, the proscenium opening shall be provided with a curtain as approved by the department.

History: 1-2-56; r. and recr. Register, May, 1971, No. 185, eff. 6-1-71.

Comm 55.24 Automatic smoke outlet. Where a fireproof proscenium curtain is required, or provided, the stage shall be provided with one or more automatic smoke outlets, constructed of metal or other incombustible material, placed near the center and above the highest part of the stage, and having a

combined area equal to not less than 8% of the area of the stage floor. Vertical louver openings shall be placed not less than 3 feet above the roof and shall be not less than twice the area of the shaft. The smoke outlet shall be designed and constructed so as to open by gravity, and so as to effectively overcome the effects of neglect, rust, dirt, frost, snow, heat, twisting, or warping of the frame work. The louvers, or dampers in the openings shall be held closed by cotton or hemp cords running to the stage floor close to each stage door. Fusible links, or other approved heat release devices, shall be inserted in each cord near the outlets.

Comm 55.25 Stage vestibules. All entrances to the stage shall be vestibuled in such manner as to protect the curtain, scenery, and auditorium from drafts of air.

Comm 55.26 Footlight trough. The footlight trough shall be made of, or lined with, incombustible material.

Comm 55.27 Fireproof paint. All stage scenery, properties, curtains, and decorations made of combustible material, and all woodwork in or about the stage, shall be effectively flameproofed.

Comm 55.28 Stage accessory rooms. (1) All property rooms and other storage or workrooms shall be built of non-combustible material throughout, and shall be separated from the stage by 4-hour fire-resistive rated construction.

(2) All dressing rooms shall be separated from the stage by 2-hour fire-resistive rated construction. No dressing room or employees' room may be placed more than one story below the grade line, and no dressing room may be placed above or below the auditorium unless separated therefrom by 2-hour fire-resistive rated construction.

History: 1-2-56; am. Register, January, 1994, No. 457, eff. 2-1-94.

Comm 55.30 Lights and lighting. (1) Electric lights shall be used for lighting where electric current is available. No oil lamps or other open lights shall be used in or about any stage containing scenery.

(2) No gas lighting of any kind shall be used on any stage containing scenery, nor in any property room, storage room, scene dock, or fly gallery, except in localities where electricity is not available.

(3) In all theaters and assembly halls, all stairways, passageways, and exit doors shall be properly lighted and shall remain lighted throughout every performance or entertainment and until the audience has left the building.

Comm 55.32 Sanitary facilities. (1) TOILET ROOMS. All occupancies included under the scope of this chapter shall be provided with separate toilet rooms for each sex. Separate toilet rooms for the employees and the general public need not be provided if the toilet rooms are accessible to both the employees and the general public.

(a) Toilet rooms in connection with stage. In theaters and assembly halls which are equipped for the showing of stage productions, separate toilet rooms for each sex, furnished with at least one water closet and one lavatory, shall be provided in connection with the stage.

(b) Toilet room in connection with motion picture booth. In theaters where motion picture machines are run continuously for a period of more than 2 hours without at least 10 minutes intermission for the motion picture machine operator for each 2-hour period, a toilet room, furnished with one water closet and one lavatory, shall be provided in direct connection with the motion picture booth.

(2) SANITARY FIXTURES. The number of water closets, urinals, lavatories and drinking facilities required for the total number of occupants of each sex shall be determined in accordance with the

ratios established in Table 55.32, but in no case shall the ratio of the number of fixtures to number of employees be less than those specified in Table 54.12-B. The total number of occupants will be considered equally divided between men and women unless a different ratio is established and submitted to the department and accepted.

Note: Chapter Comm 90 also has requirements for minimum numbers of sanitary fixtures for a public swimming pool, as based on the pool area. For some buildings, the minimum number of sanitary fixtures determined in that manner may be larger than the minimum number determined in accordance with this subsection. Compliance with this subsection does not relieve an owner from complying with ch. Comm 90.

**TABLE 55.32
NUMBER OF FIXTURES REQUIRED FOR PATRONS/OCCUPANTS
IN PLACES OF ASSEMBLY**

Number of Patrons/ Occupants of Each Sex ²	Type of Fixture ¹				
	Water Closets (WC)			Drinking Facilities (DF)	Lavatories ³ (L)
	Males (M)	Females (F)	Urinals (U)		
1-100	1	1	0		
101-200	1	2	1	One (DF) for each 150 occupants or fraction up to 600	One (L) for each 2 fixtures (WC) or (U) required, or both, or frac- tion
201-250	1	3	2		
251-300	1	4	2		
301-350	2	5	2		
351-400	2	6	2		
401-450	2	7	3		
451-500	2	8	3		
501-600	2	9	4		
Over 600	One (WC) for each additional 600 (M) or frac- tion; one for each additional 275 (F) or frac- tion		One (U) for each addi- tional 500 (M) or frac- tion	One additional (DF) for each additional 3000 occupants or fraction	
Taverns and restaurants⁴					
	One (WC) for each 75 (M) or fraction; one (WC) for each 30 (F) or fraction		One (U) ² for each 50 (M) or fraction	0	
Swimming Pools⁴					
1-100	1	2	1	One (DF) for each 150 occupants or fraction up to 600;	1
101-200	1	3	2	fraction up to 600;	2
201-400	2	4	2	one additional (DF)	2
401-700	2	4	3	for each additional	3
700+	3	5	3	3000 occupants or fraction	3

¹The ratio of the number of fixtures to the number of occupants accommodated in excess of 300 need be one-half of the figures shown.

²The urinal may be omitted in restaurants which accommodate less than 25 males and do not serve alcoholic beverages.

³A minimum of one lavatory shall be provided in each toilet room. Where a single toilet room designated as UNISEX is provided, it shall be considered as accommodating no more than 10 employees and 25 occupants.

⁴Showers shall be provided for public swimming pool facilities as required by ch. Comm 90.

Note: For structures with additions or alterations, the required number of sanitary fixtures shall be the sum of the fixtures required for the existing portion at the time it was constructed plus the fixtures required by this table for the new addition or altered area. At such time as the summation of the addition and alteration area is equal to or greater than 51% of the building area calculated as specified in s. Comm 50.03 (4) (d), fixtures shall be provided in conformance to this table utilizing the capacity of the entire building.

Note: See also rules of the department of health and family services for sanitary fixtures for mobile home parks, camping grounds, camping resorts, recreational camps and educational camps.

Note: For mixed-use facilities such as a dinner theater, use the required number for restaurants as specified in s. Comm 54.12 (2) (d) 2.

Note: See chapter Comm 69 for the percentage and design of accessible drinking facilities.

Note: For a multi-use building, as illustrated in the following example, fixtures must be provided as required for each of the differing uses represented in Table 55.32 and in the rules of other agencies. The requirements in other codes pertaining to sanitary facilities must be considered when determining fixture counts and the proximity of toilet rooms to users. When referring to the upper portion of Table 55.32, the total number of occupants/patrons of each sex in various restaurant, tavern, or pool areas of a building must be used in determining the total number of fixtures for the building.

Example: A multi-use recreation center located at a resort has 6 exercise rooms, each with a capacity of 50 patrons; 5 racquetball courts, each with a capacity of 2 persons; an aquatic area having several pools and play areas, with a combined capacity of 200 persons; and a small restaurant with a capacity of 100 persons. There are 50 employees in the building. Two sets of toilet rooms are proposed (one immediately adjacent to the restaurant to satisfy the licensing rules of another agency, and the second centrally located between the exercise rooms, racquetball courts, and aquatic area. To determine the fixtures that are required in these toilet rooms, the designer proceeds to Table 55.32. The restaurant capacity of 100 persons, when equally divided between the sexes, is 50 males and 50 females. From the part of the table applying to restaurants and males, 50 males divided by 75 = 1 water closet male, 50 males divided by 50 = 1 urinal, and 2 total fixtures divided by 2 = 1 lavatory male. For the females, 50 divided by 30 = 2 water closets female, and 2 total fixtures divided by 2 = 1 lavatory female. The aquatic area is then compared to the part of the table applying to swimming pools. For the capacity of 200 persons, using 100 patrons of each sex, males must have 1 water closet, 1 urinal, and 1 lavatory; and females must have 2 water closets and 1 lavatory. The fixtures provided in the toilet rooms for the restaurant and the aquatic area then provide the building with the following total number of fixtures. Male water closets = 1 (restaurant) + 1 (aquatic area) = 2 water closets male. Urinals = 1 (restaurant) + 1 (aquatic area) = 2 urinals. Male lavatories = 1 (restaurant) + 1 (aquatic area) = 2 lavatories male. Female water closets = 2 (restaurant) + 2 (aquatic area) = 4 water closets female. Female lavatories = 1 (restaurant) + 1 (aquatic area) = 2 lavatories female. The designer must now determine if the entire building has adequate fixtures. The total building capacity of 610 persons, when equally divided between the sexes, is 305 males and 305 females. From the upper part of Table 55.32, for 301-350 occupants of each sex, males must have 2 water closets, 2 urinals, and 2 lavatories. Therefore, the total number of fixtures initially determined for males is adequate. But, since females must have 5 water closets and 3 lavatories, the total number of fixtures initially determined for females is inadequate. An additional water closet and lavatory are needed for the females, and for ease of use, the designer chooses to locate the additional fixtures in the women's room that is by the exercise rooms and aquatic area. In a final check for compliance with Table 54.12-B for employees, 50 employees equally divided between sexes is 25 males and 25 females. In that table's row for 16-35 employees of each sex, males must have 1 water closet, 1 urinal, and 1 lavatory; and females must have 2 water closets and 1 lavatory. Therefore, the number of fixtures provided to satisfy Table 55.32 also satisfies the requirements of Table 54.12-B for employees.

History: 1-2-56; r. and recr. Register, December, 1976, No. 252, eff. 1-1-77; am. (2), Register, December, 1977, No. 264, eff. 1-1-78; am. (2), Register, December, 1978, No. 276, eff. 1-1-79; am. (2), Register, December, 1981, No. 312, eff. 1-1-82; am. table, Register, August, 1985, No. 356, eff. 1-1-86; am. (2), r. and recr. table; Register, August, 1993, No. 452, eff. 3-1-94; reprinted to correct error in table, Register, August, 1995, No. 476; am. Table 55.32, Register, September, 2000, No. 537, eff. 10-1-00.

Comm 55.33 Fire protection systems. (1) SPRINKLER SYSTEMS. Automatic fire sprinkler systems shall be provided as outlined in ss. Comm 52.01, 52.011, 52.012 and 52.013.

(2) STANDPIPE SYSTEMS. (a) Fire department standpipes. Fire department standpipes shall be provided in all buildings exceeding 60 feet in height.

(b) Dry standpipes. Dry standpipes as specified under s. Comm 51.21 shall be provided in all buildings, except churches and places of worship, having theaters and assembly halls with an occupancy load of more than 750 persons, unless an approved automatic sprinkler system is installed. First-aid standpipes shall be provided on the stage of every theater and assembly hall where a proscenium curtain is required.

(3) FIRE EXTINGUISHERS. Portable fire extinguishers shall be provided and maintained as specified in s. Comm 51.22.

History: 1-2-56; r. and recr. Register, December, 1976, No. 252, eff. 1-1-77; am. (2), Register, December, 1978, No. 276, eff. 1-1-79; emerg. r. and recr. (2), eff. 9-6-86; r. and recr. (2), Register, November, 1986, No. 371, eff. 12-1-86; r. and recr. Register, March, 1991, No. 423, eff. 4-1-91; am. (2) (b), Register, January, 1994, No. 457, eff. 2-1-94.

Comm 55.39 Use of "safety-base" film. (1) The requirements of ss. Comm 55.40 through 55.49 will not apply in buildings in which movie projectors are used with "safety-base" film provided the conditions of pars. (a) and (b) are met.

(a) The owner shall submit an affidavit to the department stating that "safety-base" film only will be used in all movie projectors.

(b) The affidavit shall be signed by the owner and the signature notarized.

Note: For definition of "owner," see s. 101.01 (2) (f), Stats.
History: Cr. Register, April, 1971, No. 184, eff. 5-1-71.

Comm 55.40 Motion picture machine booths, general. Every motion picture machine using nitro-cellulose film, together with all auxiliary and associated equipment, shall be enclosed in a booth so arranged as to permit the operator to walk freely on either side and in back of the machine. At least 48 square feet in area shall be provided for one machine, and 24 square feet additional for each machine over one. The ceiling height shall be not less than 7 feet.

Comm 55.41 Construction of booth. The floor of each motion picture booth shall be constructed of masonry or reinforced concrete, or shall be covered with not less than 2 inches of fire-resistive material. The walls and ceilings shall be not less than 2-hour fire-resistive construction as specified in s. Comm 51.04.

History: 1-2-56; am. Register, February, 1971, No. 182, eff. 7-1-71; r. and recr. eff. 8-1-71 and exp. 1-1-72; cr. eff. 1-1-72, Register, July, 1971, No. 187.

Comm 55.42 Doors. (1) The door to the booth shall be not larger than necessary for the safe and proper use and maintenance of the booth and equipment, but in no case shall its dimensions be smaller than 2 feet by 5 feet or larger than 3 feet by 7 feet. The top of the door shall be not less than 12 inches below the ceiling of the booth.

(2) The door shall be a tight-fitting self-closing fire door as specified in s. Comm 51.047, shall open outwardly, and shall not be equipped with any latch.

History: 1-2-56; am. (2), Register, February, 1971, No. 182, eff. 7-1-71; r. and recr. (2) eff. 8-1-71 and exp. 1-1-72; cr. (2) eff. 1-1-72, Register, July, 1971, No. 187.

Comm 55.43 Openings. (1) Two openings for each motion picture machine may be provided. The one for the operator's view shall not be larger than 200 square inches and the one for projection not larger than 120 square inches. Where separate stereopticon, spot, or floodlight machines are installed, not more than one opening shall be provided for each such machine for both the operator's view and the projection of light. All such openings shall be as small as practicable.

(2) Each opening shall be provided with an approved gravity shutter set into guides not less than one inch at sides and bottom, and overlapping the top of the opening by at least one inch when closed. Shutters shall be not less than No. 10 U.S. Standard gauge iron or equivalent, arranged to move freely in guides of like material and thickness bolted to the wall. Each shutter shall be suspended by a cord and shall be so arranged that closing is by gravity action. A fusible link shall be provided in the cord over each shutter. A link shall also be provided over each magazine, which on operating will close all shutters. A manual release shall be provided near each exit door by which all shutters can be closed simultaneously. Shutters shall not be blocked open nor held open in any manner except by the harness of cords and links as herein described.

Comm 55.44 Ventilation of booths. Every booth or room housing projection, sound or any other equipment which vitiates good air conditions or requires the attention of an attendant shall be ventilated as required by s. Comm 64.05. Fresh air intakes in booth walls, except for outside air, shall not exceed 72 square inches in area, nor be more than 3 inches above the floor. They shall be equipped with automatic shutters as described for projection openings.

History: 1-2-56; r. and recr. Register, October, 1967, No. 142, eff. 11-1-67; am. Register, December, 1975, No. 240, eff. 1-1-76.

Comm 55.45 Relief outlets. Every booth or room housing projection, sound or other equipment which constitutes a fire, smoke, explosion or fuming hazard shall be equipped with one or

more gravity outlets extending upward from the ceiling through the roof. The net area of such gravity relief outlets shall be equal to one per cent of the room or booth floor area, but not less than 12 inches in diameter. Such outlets shall be constructed as sheet metal ducts having double walls with $\frac{1}{2}$ inch air space between, or better construction. Where a relief outlet passes through, or is within 18 inches of any combustible construction, or passes through any other occupancy, approved masonry flues as specified for chimneys, s. Comm 64.46, shall be used. The relief outlets shall be equipped, at the booth or room outlets, with a gravity shutter which will open automatically under excessive heat conditions. The automatic shutter shall normally be tightly closed where mechanical exhaust ventilation is required in the same room.

Comm 55.46 Electric wiring. All lights and electric wiring, also motors, arc lamps, rheostats, and associated electrical equipment shall conform in type and arrangement to the requirements of the Wisconsin state electrical code, vol. 2, ch. Comm 16.

Comm 55.47 Motion picture machine. Every projection machine shall be securely fastened to the floor, and together with sound head and other associated equipment, shall be of safe design. No part of the film shall be outside of a tight metal enclosure during projection, and the feed and take-up reels shall have riveted, flanged, or welded joints. A shutter shall be placed in front of the condenser, arranged so as to be closed except when held open by the operator, or by some mechanical device which will assure immediate closure when operation of the machine is stopped.

Comm 55.48 Fire protection in booth; care and use of film. (1) All shelves, furniture and fixtures shall be incombustible. No combustible material shall be permitted to be within such booth, except films and film cement not exceeding one pint. Smoking is prohibited. Heating equipment in booths shall be lim-

ited to steam, warm air, hot water or electric convection heaters with low surface temperature elements. Radiators shall be protected by $\frac{1}{4}$ inch mesh screen with the top sloped at least 45° to the horizontal.

(2) Films not in process of rewinding, examination or projection shall be kept in metal containers. Up to 40 pounds of film may be kept in the projection booth in interstate commerce commission shipping containers. Excess over 40 pounds shall be kept in an approved film cabinet, but the total quantity of film in any booth shall not exceed 125 pounds.

(3) Rewinding in the projection booth is prohibited unless done in an approved enclosed type rewind machine. An approved can with self-closing hinged cover shall be provided for scrap film.

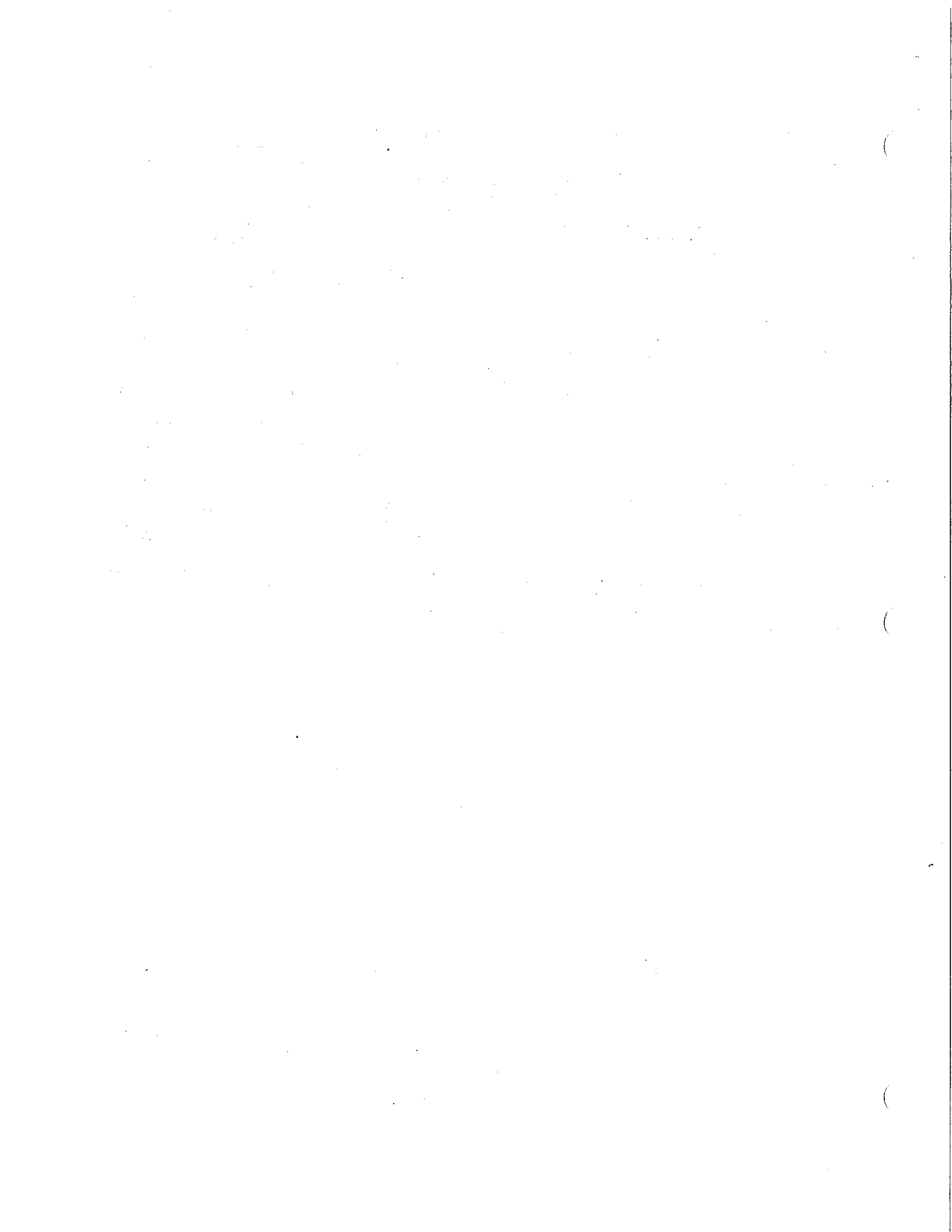
(4) Up to 125 pounds of film in addition to that permitted in a projection booth, may be kept in containers as specified above, providing this excess is in a rewind room of not less than 80 square feet area, and of the construction specified in ss. Comm 55.41 and 55.42. Such room shall have a vent of at least 50 square inches in area extending upward to the outside of the building, with a clearance to combustible material conforming to s. Comm 55.45. Furniture and heating shall be as for the projection booth, and smoking is prohibited.

Note: The weight of a 1000 foot roll of 35 millimeter film is assumed as 5 pounds.

Comm 55.49 Portable booths. (1) Every portable booth used to confine the fire hazards of a motion picture machine shall be of approved design conforming to the requirements for permanent booths.

(2) Every booth used for more than 3 consecutive performances in one location will be considered a permanent booth.

Comm 55.50 Maintenance. All theaters and assembly halls, and all parts thereof, shall be kept clean, sanitary and in good repair.



Chapter Comm 56

SCHOOLS AND OTHER PLACES OF INSTRUCTION

Subchapter I — General Requirements

- Comm 56.001 Scope.
- Comm 56.01 Maximum height.
- Comm 56.02 Classes of construction limitations.
- Comm 56.03 Protection of basement levels.
- Comm 56.05 Exterior wall openings.
- Comm 56.06 Exits.
- Comm 56.07 Required exit width.
- Comm 56.08 Exit doors.
- Comm 56.09 Passageways.
- Comm 56.10 Enclosure of stairways and shafts.
- Comm 56.13 Assembly seating.
- Comm 56.14 Seats, desks and aisles.
- Comm 56.145 Occupancy separations and hazard enclosures.
- Comm 56.16 Sanitary facilities.
- Comm 56.17 Lighting.
- Comm 56.19 Fire alarms.
- Comm 56.20 Fire protection systems.

Subchapter II — Relocatable Classrooms

- Comm 56.30 Scope.
- Comm 56.31 Definitions.
- Comm 56.32 General.
- Comm 56.33 Anchoring requirements.
- Comm 56.34 Exit doors and exit lights.
- Comm 56.35 Class of construction separations.
- Comm 56.36 Barrier-free requirements.
- Comm 56.37 Sanitary facilities.
- Comm 56.38 Fire alarms.

Subchapter III — Mobile Training Units

- Comm 56.40 Scope.
- Comm 56.41 Definitions.
- Comm 56.42 General.
- Comm 56.43 Exit doors and exit lights.
- Comm 56.44 Barrier-free requirements.
- Comm 56.45 Sanitary facilities.
- Comm 56.46 Fire alarms.

Note: Chapter Ind 56 was renumbered to be ch. ILHR 56, effective January 1, 1984. Sections ILHR 56.50 to 56.57 were created as emergency rules effective 7-3-89. Sections ILHR 56.60 to 56.70 were created as emergency rules effective 9-6-89. Corrections made under s. 13.93 (2m) (b) 7., Stats., Register, March, 1997, No. 495. Chapter ILHR 56 was renumbered to be chapter Comm 56 under s. 13.93 (2m) (b) 1. and corrections were made under s. 13.93 (2m) (b) 7., Stats., Register, December, 1997, No. 504.

Subchapter I — General Requirements

Comm 56.001 Scope. The requirements of this chapter shall apply to all public and private schools, universities, colleges, academies, seminaries, libraries, museums and art galleries; including all buildings or parts of buildings used primarily for instructional purposes. This chapter does not apply to those types of art galleries where art work is intended for sale, dance studios or schools, nonacademic-music studios or schools, nonacademic-art studios or schools, self-defense schools, or other similar nonacademic training occupancies; such occupancies shall be regulated by the provisions of ch. Comm 54.

History: 1-2-56; am. Register, May, 1971, No. 185, eff. 6-1-71; am. Register, December, 1977, No. 264, eff. 1-1-78; am. Register, January, 1980, No. 289, eff. 2-1-80; am. Register, March, 1991, No. 423, eff. 4-1-91.

Comm 56.01 Maximum height. (1) Buildings occupied primarily by pupils up to and including grade 12 shall not exceed 4 stories or 48 feet in height.

(a) **Exception.** Buildings provided with complete automatic sprinkler or automatic smoke detection systems, occupied primarily by students of grades 9 through 12, shall be no more than 6 stories or 72 feet in height.

Note: Also see requirements for classes of construction.

History: 1-2-56; r. Register, May, 1971, No. 185, eff. 6-1-71; cr. Register, September, 1973, No. 213, eff. 10-1-73.

Comm 56.02 Classes of construction limitations. (1) Buildings within the scope of this chapter may not exceed the number of stories and height limits as specified in Table 56.02-1 based upon the type of construction utilized.

(2) Those portions of buildings used as auditoriums, gymnasiums, field houses or assembly halls shall conform with the construction limitations specified in s. Comm 55.02.

Table 56.02-1
MAXIMUM NUMBER OF STORIES

Class of Construction	Sprinklered ^a		Nonsprinklered	
	Height (in feet)	Number of Stories	Height (in feet)	Number of Stories
Type 1	No limit	No limit	60 ^b	No limit
Type 2	95	9	60 ^b	8
Type 3	85	3	60 ^b	2
Type 4	85	3	60 ^b	2
Type 5A	60	3	50	2
Type 5B	50	3	40	2
Type 6	60	3	50	2
Type 7	50	2	40	1
Type 8	45	2	35	1

^aAn automatic fire sprinkler system designed and installed in accordance with s. Comm 51.23 is provided throughout the entire building.

^bSection Comm 52.01 requires the installation of sprinklers for buildings more than 60 feet in height.

History: 1-2-56; r. and recr. Register, May, 1971, No. 185, eff. 6-1-71; am. (1) and (2) and r. and recr. (3), Register, June, 1972, No. 198, eff. 1-1-73; cr. (4), Register, September, 1973, No. 213, eff. 10-1-73; r. and recr. (4) (a) 1., Register, May, 1974, No. 221, eff. 6-1-74; am. (4) (a) 1., Register, December, 1978, No. 276, eff. 1-1-79; emerg. am. (1) to (3), renum. (4) to (5) and r. and recr. (5) (a) and (b), cr. (4), eff. 9-6-86; am. (1) to (3), renum. (4) to be (5) and r. and recr. (5) (a) and (b), cr. (4), Register, November, 1986, No. 371, eff. 12-1-86; r. and recr. Register, March, 1991, No. 423, eff. 4-1-91.

Comm 56.03 Protection of basement levels. (1) GENERAL REQUIREMENT. Buildings with basements shall at such levels be protected with an approved automatic sprinkler system as specified in s. Comm 51.23 or an approved automatic smoke detection system, as specified in s. Comm 51.245, either of which shall be electrically connected to the required fire alarm system.

Note: See s. Comm 51.245 for additional requirements pertaining to smoke detectors.

Note: See ss. Comm 52.012 (1) and 52.02 for additional requirements pertaining to basements.

(2) **RETROACTIVITY.** Existing buildings which do not conform to the requirements specified in sub. (1) on or after January 1, 1983 shall comply with the following:

(a) The corridors in the basement shall be protected by an approved smoke detection system.

(b) Smoke detection systems shall be installed in accordance with NFPA No. 72; but in no case shall smoke detectors be spaced more than 30 feet apart on center or more than 15 feet from any wall.

Note: See s. Comm 51.01 for definitions of "automatic" and "basement."

History: Cr. Register, January, 1980, No. 289, eff. 2-1-80; cr. (2), eff. 1-1-83, am. (1), Register, December, 1981, No. 312, eff. 1-1-82; am. (2) (b), Register, March, 1991, No. 423, eff. 4-1-91; correction in (2) (intro.) made under s. 13.93 (2m) (b) 14., Stats., Register, March, 1991, No. 423; am. (2) (b), Register, February, 1999, No. 518, eff. 3-1-99.

Comm 56.05 Exterior wall openings. (1) ONE-STORY BUILDINGS. One-story buildings with no floor levels below the first floor need not be provided with exterior wall openings other than required exits.

(2) MULTI-STORY BUILDINGS. (a) Except as provided in par. (b), buildings more than one story shall be provided with fire department access openings as specified in s. Comm 52.02 (2).

(b) Fire department access openings are not required provided the building is protected throughout by an automatic fire sprinkler system and that system is connected to the required fire alarm system.

History: 1-2-56; am. Register, January, 1961, No. 61, eff. 2-1-61; r. and recr., Register, May, 1971, No. 185, eff. 6-1-71; r. and recr., Register, September, 1973, No. 213, eff. 10-1-73; r. (2) and renum. (3) to be (2), Register, January, 1980, No. 289, eff. 2-1-80; r. and recr. Register, June, 1983, No. 330, eff. 7-1-83.

Comm 56.06 Exits. (1) TOTAL NUMBER OF EXITS. The total number of exits from each floor level and each building shall be determined on the basis of total aggregate exit width and distances to exit. Each building and each floor level shall be provided with at least 2 exits.

(2) TYPE OF EXITS. At least 2 exits from all floor levels shall lead directly to grade through standard exit doors, stairs, interior enclosed stairs, smokeproof stair towers, fire-rated exit corridors, passageways, or ramps. One-half of the remaining required exits may be horizontal exits or fire escapes. Fire escapes are prohibited as required exits in pre-school, elementary, middle, and high schools. In no case will fire escapes be permitted above the second story.

(a) *Standard exit doors.* Standard exit doors shall be provided in accordance with the requirements of ss. Comm 51.15 and 56.08.

(b) *Stairs.* Stairs shall conform to the requirements of ss. Comm 51.16 to 51.166, except that handrails shall be provided on both sides, and no closets or rooms may be placed under a stairway or landing.

(c) *Interior enclosed stairs and smokeproof stair towers.* Interior enclosed stairs and smokeproof stair towers shall conform with ss. Comm 51.18 and 51.17, respectively.

(d) *Fire-rated exit corridors.* All rated exit corridors required to satisfy limitations on exit distance shall be of not less than one-hour fire-resistive construction, unless the fire-resistive ratings indicated in Table 51.03-A for required exit corridor enclosures are more restrictive.

(e) *Exit ramps.* The minimum width of exit ramps shall be determined in accordance with the requirements of s. Comm 56.07. The minimum width shall be not less than 3 feet 8 inches. Exit ramps, other than those required for the physically disabled, shall have a slope not exceeding 1:8. Ramp slopes exceeding 1:12 shall be provided with handrails. Ramps shall be provided with a slip-resistant finish. Ramps shall be provided from areas noted under sub. (3) (c) involving a change of elevation between floor levels or platforms not exceeding 3 feet.

(f) *Fire escapes.* Fire escapes shall be constructed in accordance with the requirements of s. Comm 51.20.

(g) *Horizontal exits.* Horizontal exits shall be constructed in accordance with the requirements of s. Comm 51.19 and shall be of at least 4-hour rated construction.

(3) LOCATION OF EXITS. (a) *Exit distance.* 1. Travel distance to an exterior exit door, a required fire-resistive rated exit corridor, interior enclosed stairs, smokeproof stair tower, horizontal exit, or fire escape, from any point in a building accessible to the public, shall not exceed 150 feet.

2. Where an approved automatic fire sprinkler system is provided throughout the building, an increase in exit distance to 200 feet will be permitted.

3. Building service areas, including pipe chases and tunnels, catwalks, ducts or similar spaces not accessible to the public, shall not exceed 300 feet from an exit.

(b) *Distribution of exits.* All exits shall be distributed to provide the best possible means of egress. The exits shall be located so that in case any exit is blocked at any point some other exit is accessible through public passageways at all times. Locked security gates and doors shall not be placed so as to block required exit passageways or create dead-end corridors.

(c) *Auditorium, gymnasium and field house exits.* This rule shall apply only to auditoriums, gymnasiums and field houses which have a capacity exceeding 600 persons. One-half of the required exits shall discharge directly to a street, alley or open court connected with a street, unless a 2-hour rated exit corridor is provided, wide enough to accommodate one-half of the occupants, which extends from the interior wall of the auditorium, gymnasium or field house to an exterior exit. The remaining required exits shall discharge directly to the exterior or to a public passageway which permits 2 directions of travel to the exits at the exterior of the building. The exiting shall be direct and unobstructed.

(4) CLASSROOM EXITS. (a) *Scope.* This subsection shall apply only to rooms for formal instruction of students with direct teacher supervision. This subsection does not apply to other parts of schools or places of instruction, including but not limited to, cafeterias, instructional media centers, gymnasiums, industrial arts shops, laboratories, or locker rooms.

(b) *Exits serving 50 persons or less.* At least one exit shall be provided from all rooms serving a capacity of 50 persons or less. The exit shall discharge directly to the exterior of the building or to a public passageway which permits 2 directions of travel to the exterior.

(c) *Exits serving 51-100 persons.* At least 2 exits shall be provided from all rooms serving a capacity of 51-100 persons. One exit shall discharge directly to the exterior of the building or to a public passageway which permits 2 directions of travel to the exterior. One exit may discharge through an adjacent room provided a clear passageway is maintained from the connecting door to a required exit serving the adjacent room.

(d) *Exits serving more than 100 persons.* At least 2 exits shall be provided from all rooms serving a capacity of more than 100 persons. The exits shall discharge directly to grade or to a public passageway which permits 2 directions of travel to the exterior.

(5) WIDTH OF EXITS. The total required exit width shall be provided in accordance with the requirements of s. Comm 56.07.

(6) EXIT LIGHTS. All required exits indicated in s. Comm 56.06 (2), and exits from areas serving a capacity of more than 100 persons, shall be identified by an approved exit light. Directional exit lights shall be provided to direct occupants to an exit. Exit lights and directional exit lights shall be as specified in s. Comm 51.15 (5).

History: 1-2-56; am. (1), cr. (1) (a), Register, September, 1959, No. 45, eff. 10-1-59; am. Register, January, 1961, No. 61, eff. 2-1-61; r. and recr. (1) (a), renum. (2) to be (3), (3) to be (4), (4) to be (5), (5) to be (6) and (6) to be (7), and cr. (2) and (6), Register, May, 1971, No. 185, eff. 6-1-71; r. and recr., Register, September, 1973, No. 213, eff. 10-1-73; am. (1) (a) 2., Register, December, 1974, No. 228, eff. 1-1-75, r. and recr. Register, December, 1975, No. 240, eff. 1-1-76; am. (2), intro.

and cr. (2) (g), Register, December, 1976, No. 252, eff. 1-1-77; am. (6), Register, December, 1983, No. 336, eff. 1-1-84; emerg. am. (3) (a), eff. 9-6-86; am. (3) (a), Register, November, 1986, No. 371, eff. 12-1-86; am. (2) (b) and (c), Register, March, 1991, No. 423, eff. 4-1-91; am. (2) (b), renum. (4) (a) to (c) to be (4) (b) to (d), cr. (4) (a), Register, January, 1994, No. 457, eff. 2-1-94.

Comm 56.07 Required exit width. (1) The total required exit width from a building level shall be in accordance with the requirements of ss. Comm 51.15 (6) and 51.16 (3).

(2) The capacity of educational buildings or any individual story or section thereof for the purpose of determining exits shall be the maximum capacity designated on approved plans.

(a) The maximum capacity shall not exceed the requirements of par. (b).

(b) The maximum capacities of all rooms and spaces as listed below shall be determined on the basis of the minimum net square feet area per person shown for that occupancy unless otherwise designated on the plans.

	Minimum Square Feet Per Occupant
1. Academic classrooms — Regular	20
2. Administrative and office space	75
3. Arts, crafts, drafting	30
4. Bleachers (one seat per 18 inches of bench length)	
5. Gymnasiums, field houses, auditoriums, theatres, lecture rooms (fixed seating)	6
6. Gymnasiums, field houses, multipurpose rooms, cafeterias, study halls, commons and other level floor areas with nonfixed individual seating	10
7. Home economics, business education	30
8. Industrial arts—vocational shop	50
9. Laboratories—Science (fixed lab. tables)	30
10. Libraries and resource centers	20
11. Museums and art galleries	40
12. Music	
a. Vocal	10
b. Instrumental	20
13. Special education	
a. Mentally retarded, physically handicapped, etc.	35

History: 1-2-56; r. and recr. (3), Register, May, 1971, No. 185, eff. 6-1-71; am. (1), Register, June, 1972, No. 198, eff. 1-1-73; r. and recr., Register, September, 1973, No. 213, eff. 10-1-73; r. and recr. (1), r. (2), (3) and (4), renum. (5) to be (2), Register, December, 1974, No. 228, eff. 1-1-75.

Comm 56.08 Exit doors. (1) STANDARD EXIT DOORS. Exit doors shall comply with the requirements of s. Comm 51.15. The aggregate width of exit doors shall be as required in s. Comm 56.07. No single door or leaf of a double door shall be more than 42 inches wide.

(2) CLASSROOM EXIT DOOR WIDTH AND SWING. (a) Classroom doors serving 50 persons or less. Classroom doors serving classrooms with a capacity of 50 persons or less shall be not less than 3 feet 0 inches in width. The doors may swing into the classroom.

(b) Classroom doors serving more than 50 persons. Classroom doors serving classrooms with a capacity of more than 50 persons shall be standard exit doors and shall swing outward toward the means of egress.

(3) ALL OTHER EXIT DOORS. Doors serving areas other than classrooms shall comply with s. Comm 54.06.

History: 1-2-56; r. and recr. Register, December, 1975, No. 240, eff. 1-1-76; am. (2) and cr. (3), Register, December, 1978, No. 276, eff. 1-1-79; am. (1) and (2) (b), r. (2) (c), Register, January, 1980, No. 289, eff. 2-1-80.

Comm 56.09 Passageways. (1) The minimum unobstructed width of corridors and passageways which are used by the public or by the occupants generally, shall be determined in the same manner as specified for stairways in s. Comm 56.07, but in no case shall this width be less than 4 feet. Corridors and passageways serving as a means of egress shall be at least equal in combined width to the required width of the stairways or passageways leading to them.

History: 1-2-56; r. (1) and renum. (2) to be (1), Register, May, 1971, No. 185, eff. 6-1-71.

Comm 56.10 Enclosure of stairways and shafts. All stairways and shafts shall be enclosed in accordance with s. Comm 51.02 (11).

History: Cr. Register, March, 1991, No. 423, eff. 4-1-91.

Comm 56.13 Assembly seating. All assembly seating in auditoriums, gymnasiums, field houses and other large group occupancy areas shall comply with the requirements of subch. V of ch. Comm 62, Assembly Seating Facilities. Where any area of a building in this category has a stage loft in excess of 25 feet 0 inches in height above the stage floor and is equipped with permanent or movable scenery, it shall comply with ss. Comm 55.21 through 55.30.

History: 1-2-56; r. and recr., Register, May, 1971, No. 185, eff. 6-1-71; r. and recr., Register, December, 1981, No. 312, eff. 1-1-82.

Comm 56.14 Seats, desks and aisles. (1) Seats, desks, tables and other loose equipment need not be fastened to the floor or to each other provided that any seating arrangement use, will maintain during occupancy, free and unobstructed intermediate, cross and wall aisles leading to the exit.

(a) Stepped floors or tiered platforms shall be no less than 48 inches in width to permit the above arrangement.

(b) Seats, desks, tables and other loose equipment used in instructional occupancies shall be of a durable type of construction to assure safety and stability.

History: 1-2-56; r. and recr., Register, May, 1971, No. 185, eff. 6-1-71.

Comm 56.145 Occupancy separations and hazard enclosures. Occupancies within the scope of this chapter shall be separated from other occupancies or uses in accordance with s. Comm 51.08. Hazards shall be enclosed in accordance with s. Comm 51.08.

History: Cr. Register, March, 1991, No. 423, eff. 4-1-91; r. and recr., Register, December, 1995, No. 480, eff. 4-1-96; r. and recr. Register, March, 1997, No. 495, eff. 4-1-97.

Comm 56.16 Sanitary facilities. (1) TOILET ROOMS. Separate toilet rooms for each sex shall be provided for all occupancies included under the scope of this chapter. The toilet rooms shall be completely enclosed and arranged to ensure privacy.

(2) SEX DESIGNATION. Where separate toilet rooms are required by this code, each toilet room shall be clearly marked for which it is designated as specified in s. Comm 52.52.

(3) SANITARY FIXTURES. (a) The number of sanitary fixtures shall be determined by the number of persons of each group or combination of groups using Table 56.16. The number of persons in each group shall be designated on the plans.

(b) When fixtures required for a designated group are not available to another designated group, the number of fixtures shall be provided according to the ratio indicated in Table 56.16 and independent of the number or ratio of fixtures provided for another group.

(c) Where a theater is a part of an educational facility the requirements for the number of fixtures to be provided shall be determined as specified in Table 56.16 for large group areas.

TABLE 56.16
NUMBER OF PERSONS BY GROUP FOR EACH TYPE OF SANITARY FIXTURE FOR OCCUPANTS¹

Type of Fixture	Number of Persons per Fixture by Designated Group ²				
	Grades K-6	Grades 7-12	Post High School	Large Group Area	Administrative Area
Water Closets (WC) (F)	35	50	100	200	10
Water Closets (WC) (M)	75	100	200	300	15
Urinals (U) (M) ³	35	50	100	150	40
Lavatories (L) ⁴	75	100	100	150	15
Drinking Fountains (DF)	40	50	50	150	100

¹ For the purposes of this table, please refer to the appropriate occupancy chapter. Where a single toilet room designated as UNISEX is provided, it shall be considered as accommodating no more than 10 employees and 25 occupants.

² Example: For grades K-6, one (WC) for each 35 (F), one (WC) for each 75 (M) and one (U) for each 35 (M) need to be provided.

³ Section Comm 52.60 (2) (b) allows only stall-type urinals in schools for grades K-8.

⁴ A minimum of one (L) and one (WC) shall be provided in each toilet room.

Note: For structures with additions or alterations, the required number of sanitary fixtures shall be the sum of the fixtures required for the existing portion at the time it was constructed plus the fixtures required by this table for the new addition or altered area. At such time as the summation of the addition and alteration area is equal to or greater than 51% of the building area calculated as specified in s. Comm 50.03 (4) (d), fixtures shall be provided in conformance to this table utilizing the capacity of the entire building.

Note: See chapter Comm 69 for the percentage and design of accessible drinking facilities.

History: 1-2-56; am. (2), (3), (4) and (4) (a), Register, September, 1959, No. 45, eff. 10-1-59, r. and recr. (4), intro. par., Register, December, 1967, No. 144, eff. 1-1-68; r. and recr. Register, May 1971, No. 185, eff. 6-1-71; am. (1) (intro.), r. and recr. (1) (a), cr. (1) (b), Register, September, 1973, No. 213, eff. 10-1-73; renun. (1) to be (2) and cr. (1), Register, December, 1976, No. 252, eff. 1-1-77; am. (1), renun. (2) to be (3) and am., cr. (2), table, Register, August, 1993, No. 452, eff. 3-1-94.

Comm 56.17 Lighting. (1) ELECTRIC LIGHTING. Every class, study or recitation room shall be equipped with sufficient electrical lighting units to maintain the illumination required in ch. Comm 73.

(2) GENERAL. All other rooms and spaces in school buildings shall be equipped with means for supplying electric illumination in the quantity required for the purpose for which the room or space is used. All electrical work shall be installed to conform to the requirements of the Wisconsin state electrical code, vol. 2, ch. Comm 16.

History: 1-2-56; am. Register, January, 1961, No. 61, eff. 2-1-61; cr. (3), Register, November, 1963, No. 95, eff. 12-1-63; am. (3) (c), Register, February, 1971, No. 182, eff. 7-1-71; r. and recr. Register, May, 1971, No. 185, eff. 6-1-71; correction in (1) made under s. 13.93 (2m) (b) 7., Stats., Register, December, 1995, No. 480.

Comm 56.19 Fire alarms. Every building shall be provided with a proper alarm system complying with s. Comm 51.24.

History: 1-2-56; am. Register, May, 1971, No. 185, eff. 6-1-71.

Comm 56.20 Fire protection systems. (1) SPRINKLER SYSTEMS. Automatic fire sprinkler systems shall be provided as outlined in ss. Comm 52.01, 52.011, 52.012 and 52.013.

(2) STANDPIPE SYSTEMS. (a) Fire department standpipes. Fire department standpipes shall be provided in all buildings exceeding 60 feet in height.

(b) Dry standpipes. Dry standpipes shall be provided in all buildings 3 stories or more in height, unless an approved automatic sprinkler system is installed.

(3) FIRE EXTINGUISHERS. Portable fire extinguishers shall be provided and maintained as specified in s. Comm 51.22.

History: Cr. Register, December, 1976, No. 252, eff. 1-1-77; emerg. r. and recr. (2), eff. 9-6-86; r. and recr. (2), Register, November, 1986, No. 371, eff. 12-1-86; r. and recr. Register, March, 1991, No. 423, eff. 4-1-91.

Comm 56.21 Public school inspections. History: Cr. Register, October, 1992, No. 442, eff. 11-1-92; r. Register, September, 2000, No. 537, eff. 10-1-00.

Subchapter II — Relocatable Classrooms

Comm 56.30 Scope. This part provides the minimum requirements for the design and construction of relocatable classrooms as defined in s. Comm 56.31.

History: Cr. Register, December, 1978, No. 276, eff. 1-1-79.

Comm 56.31 Definitions. "Relocatable classrooms" mean mobile home type structures located on permanent foundations and equipped and used for educational instruction.

History: Cr. Register, December, 1978, No. 276, eff. 1-1-79.

Comm 56.32 General. Relocatable classrooms shall comply with the applicable sections of this code except as otherwise specified in this part.

History: Cr. Register, December, 1978, No. 276, eff. 1-1-79.

Comm 56.33 Anchoring requirements. Provisions acceptable to the department for the prevention of overturning of the relocatable classroom as a result of wind pressure shall be made.

Note: The department accepts provisions such as ground anchors installed in accordance with ANSI standard A 119.1.

History: Cr. Register, December, 1978, No. 276, eff. 1-1-79.

Comm 56.34 Exit doors and exit lights. (1) EXIT DOORS. Exit doors shall be at least 3 feet 0 inches in width.

(2) EXIT LIGHTS. Illuminated exit lights are not required in relocatable classrooms.

History: Cr. Register, December, 1978, No. 276, eff. 1-1-79.

Comm 56.35 Class of construction separations. Relocatable classrooms connected to another building shall be separated by class of construction separations as specified in s. Comm 51.02 (20).

History: Cr. Register, December, 1978, No. 276, eff. 1-1-79; am. Register, December, 1983, No. 336, eff. 1-1-84.

Comm 56.36 Barrier-free requirements. An accessible entrance, interior circulation, and toilet facilities for people with disabilities need not be provided for a relocatable classroom if the courses taught in the relocatable classroom are available in accessible facilities at the same school site.

History: Cr. Register, December, 1978, No. 276, eff. 1-1-79; am. Register, January, 1994, No. 457, eff. 2-1-94.

Comm 56.37 Sanitary facilities. (1) SANITARY FIXTURES. The number of sanitary fixtures for relocatable classrooms shall be provided in accordance with the requirements of ss. Comm 52.50 through 52.64 and 56.16.

(a) Exception. Sanitary fixtures need not be provided in each relocatable classroom structure if the sanitary fixtures in the main school building are convenient and available for use during all

hours of operation and the relocatable classroom structure is connected to the main school building with an enclosed passageway.

History: Cr. Register, December, 1978, No. 276, eff. 1-1-79; am., Register, August, 1993, No. 452, eff. 3-1-94.

Comm 56.38 Fire alarms. Relocatable classroom structures containing more than 2 classrooms or connected to another building shall be provided with a fire alarm system as specified in s. Comm 51.24.

History: Cr. Register, December, 1978, No. 276, eff. 1-1-79.

Subchapter III — Mobile Training Units

Comm 56.40 Scope. This part provides the minimum requirements for mobile training units as defined in s. Comm 56.41.

History: Cr. Register, December, 1978, No. 276, eff. 1-1-79.

Comm 56.41 Definitions. "Mobile training units" mean trailer type units constructed and left on wheels. Mobile training units are used for education purposes at one site for a period of time no greater than 9 weeks per year.

History: Cr. Register, December, 1978, No. 276, eff. 1-1-79.

Comm 56.42 General. Mobile training units shall comply with the applicable sections of this code except as otherwise specified in this part.

History: Cr. Register, December, 1978, No. 276, eff. 1-1-79.

Comm 56.43 Exit doors and exit lights. (1) EXIT DOORS. Exit doors shall be at least 3 feet 0 inches wide.

(2) EXIT LIGHTS. Illuminated exit lights are not required for mobile training units.

History: Cr. Register, December, 1978, No. 276, eff. 1-1-79.

Comm 56.44 Barrier-free requirements. An accessible entrance, interior circulation, and toilet facilities for people with disabilities need not be provided for mobile training units if the courses taught in the mobile training units are available in accessible facilities at the same school site.

History: Cr. Register, December, 1978, No. 276, eff. 1-1-79; am. Register, January, 1994, No. 457, eff. 2-1-94.

Comm 56.45 Sanitary facilities. (1) TOILET ROOMS. (a) Toilet rooms within the mobile training unit shall comply with the requirements of ss. Comm 52.50 through 52.64 and 56.16.

(b) Toilet rooms in the mobile training unit in which the toilet room door is equipped with a privacy lock, the requirements specified in s. Comm 52.59 are not applicable.

(2) SANITARY FIXTURES. Sanitary fixtures are not required in the mobile training unit provided the sanitary fixtures in the main school building are available for use during all hours of operation.

(3) ACCESSIBILITY. Toilet facilities accessible for the physically disabled need not be provided if accessible toilet facilities in

the main school building are provided and available for use during all hours of operation.

History: Cr. Register, December, 1978, No. 276, eff. 1-1-79; r. and recr., Register, August, 1993, No. 452, eff. 3-1-94.

Comm 56.46 Fire alarms. Mobile training units used individually are exempt from the provisions of s. Comm 56.19.

History: Cr. Register, December, 1978, No. 276, eff. 1-1-79.

Comm 56.50 Scope. **History:** Cr. Register, April, 1990, No. 412, eff. 5-1-90; r. Register, September, 2000, No. 537, eff. 10-1-00.

Comm 56.51 Purpose. **History:** Cr. Register, April, 1990, No. 412, eff. 5-1-90; r. Register, September, 2000, No. 537, eff. 10-1-00.

Comm 56.52 Definitions. **History:** Cr. Register, April, 1990, No. 412, eff. 5-1-90; r. Register, September, 2000, No. 537, eff. 10-1-00.

Comm 56.53 Schools constructed prior to 1930. **History:** Cr. Register, April, 1990, No. 412, eff. 5-1-90; r. Register, September, 2000, No. 537, eff. 10-1-00.

Comm 56.54 Schools constructed between January 1, 1930, and January 1, 1950. **History:** Cr. Register, April, 1990, No. 412, eff. 5-1-90; r. Register, September, 2000, No. 537, eff. 10-1-00.

Comm 56.56 Extension of time for compliance. **History:** Cr. Register, April, 1990, No. 412, eff. 5-1-90; r. Register, September, 2000, No. 537, eff. 10-1-00.

Comm 56.57 Failure to comply. **History:** Cr. Register, April, 1990, No. 412, eff. 5-1-90; r. Register, September, 2000, No. 537, eff. 10-1-00.

Comm 56.58 Life-safety evaluation procedures. **History:** Cr. Register, April, 1990, No. 412, eff. 5-1-90; r. Register, September, 2000, No. 537, eff. 10-1-00.

Comm 56.59 Plan of school. **History:** Cr. Register, April, 1990, No. 412, eff. 5-1-90; r. Register, September, 2000, No. 537, eff. 10-1-00.

Comm 56.60 Plans and specifications. **History:** Cr. Register, April, 1990, No. 412, eff. 5-1-90; r. Register, September, 2000, No. 537, eff. 10-1-00.

Comm 56.61 Approval of alternate life-safety plan. **History:** Cr. Register, April, 1990, No. 412, eff. 5-1-90; am. (1) (a) 1., Register, February, 1999, No. 518, eff. 3-1-99; r. Register, September, 2000, No. 537, eff. 10-1-00.

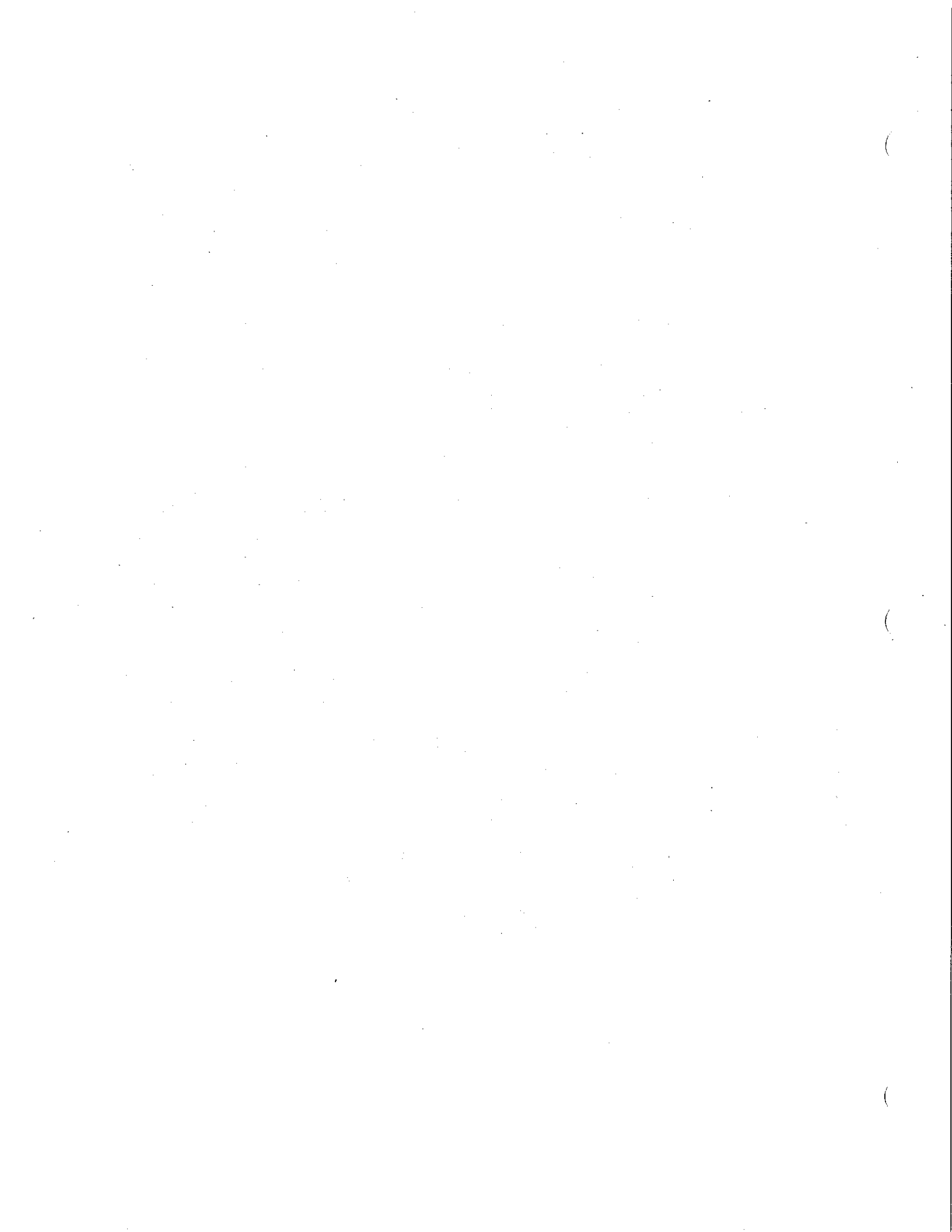
Comm 56.62 Re-evaluation. **History:** Cr. Register, April, 1990, No. 412, eff. 5-1-90; r. Register, September, 2000, No. 537, eff. 10-1-00.

Comm 56.63 Life-safety standards. **History:** Cr. Register, April, 1990, No. 412, eff. 5-1-90; am. (2) (b) 3., Register, March, 1991, No. 423, eff. 4-1-91; am. (2) (b) 2., Register, January, 1994, No. 457, eff. 2-1-94; am. (9) (b) 2., Register, February, 1999, No. 518, eff. 3-1-99; r. Register, September, 2000, No. 537, eff. 10-1-00.

Comm 56.64 Stairway smoke-enclosure. **History:** Cr. Register, April, 1990, No. 412, eff. 5-1-90; am. (3) (a), Register, February, 1999, No. 518, eff. 3-1-99; r. Register, September, 2000, No. 537, eff. 10-1-00.

Comm 56.65 Stairway smoke cut-offs. **History:** Cr. Register, April, 1990, No. 412, eff. 5-1-90; am. (3) (a), Register, February, 1999, No. 518, eff. 3-1-99; r. Register, September, 2000, No. 537, eff. 10-1-00.

Comm 56.66 Horizontal separations. **History:** Cr. Register, April, 1990, No. 412, eff. 5-1-90; r. Register, September, 2000, No. 537, eff. 10-1-00.



Chapter Comm 57

RESIDENTIAL OCCUPANCIES

Subchapter I — General Standards for Residential Occupancies

Comm 57.001	Scope.
Comm 57.01	Construction.
Comm 57.015	Height of first floor above grade for sheltered facilities for battered women.
Comm 57.016	Automatic fire sprinkler protection.
Comm 57.02	Allowable height and area.
Comm 57.03	Number and location of exits.
Comm 57.04	Capacity of buildings and exits.
Comm 57.05	Type of exits.
Comm 57.06	Doors.
Comm 57.07	Steps, stairs and shafts.
Comm 57.08	Enclosure of interior stairways and shafts.
Comm 57.09	Passageways.
Comm 57.10	Illumination of exits and exit signs.
Comm 57.11	Habitable rooms with floors below grade.
Comm 57.12	Sanitary facilities.
Comm 57.13	Windows.
Comm 57.145	Occupancy separations and hazard enclosures.
Comm 57.15	Fire protection systems.
Comm 57.16	Smoke detection.
Comm 57.165	Smoke detection for CBRF.
Comm 57.17	Fire alarms.
Comm 57.18	Fire extinguishers.
Comm 57.19	Rowhouse.

Comm 57.20 Accessibility requirements.

Subchapter II — Accessibility Standards for Covered Multifamily Housing

Part 1—Scope, Purpose and Application	
Comm 57.70	Scope.
Comm 57.71	Purpose.
Part 2—Departmental Action	
Comm 57.74	Plan examination and department action.
Part 3—Definitions	
Comm 57.77	Definitions.
Part 4—General Requirements	
Comm 57.78	Accessibility requirements, new construction.
Comm 57.79	Accessibility requirements for additions and remodeled covered multifamily housing.
Part 5—Accessibility Requirements	
Comm 57.81	Accessible building entrance on an accessible route.
Comm 57.82	Accessible and usable public and common use areas.
Comm 57.83	Usable doors.
Comm 57.84	Accessible route into and through the covered dwelling unit.
Comm 57.85	Light switches, electrical outlets, thermostats and other environmental controls in accessible locations.
Comm 57.86	Reinforced walls for grab bars.
Comm 57.87	Usable kitchens.
Comm 57.871	Usable bathrooms.

Note: Chapter Ind 57 as it existed on December 31, 1981 was repealed and a new ch. Ind 57 was created effective 1-1-82, except for s. Ind 57.16 (2) which is effective 1-1-83; chapter Ind 57 was renumbered to be ch. ILHR 57 effective January 1, 1984.

Note: Chapter ILHR 57 was renumbered to be chapter Comm 57 under s. 13.93 (2m) (b) 1. and corrections were made under s. 13.93 (2m) (b) 7., Stats., Register September, 1998, No. 513.

Subchapter I — General Standards for Residential Occupancies

Comm 57.001 Scope. (1) GENERAL. Except as provided in sub. (2) and s. Comm 50.04, this subchapter applies to all places of abode, including, but not limited to:

- (a) Apartment buildings, residential condominiums, and townhouses, that exceed 60 feet in height or 6 stories;
- (b) Motels;
- (c) Hotels;
- (d) Dormitories;
- (f) Sheltered facilities for battered women, as specified in s. 46.95, Stats., serving more than 20 occupants;
- (g) Rooming houses;
- (h) Convents and monasteries;
- (i) Community-based residential facilities serving 9 or more unrelated adults; and
- (j) Community-based facilities located in existing buildings serving more than 20 unrelated adults.
- (k) Any alterations or additions to an apartment building, rowhouse, town house, condominium, or manufactured building as defined in s. 101.71 (6), Stats., that was approved under this code prior to the implementation of ch. Comm 66 in 1995.

Note: See s. Comm 51.01 (102a) and 51.01 (114a) for definitions of "places of abode" and "rowhouse", respectively.

(2) EXEMPTIONS. The requirements of this subchapter shall not apply to the following:

- (a) Buildings or motels, tourist courts and similar occupancies having separate buildings containing not more than 2 rental units each;
- (b) Health care facilities;
- (c) Places of detention;

(d) Community-based residential facilities constructed on or after the effective date of this section and serving 3 to 8 unrelated adults;

(e) Community-based residential facilities, serving 9 to 20 unrelated adults, located in existing buildings as specified in ss. Comm 61.001 (1) and 61.01 (7);

(f) Sheltered facilities for battered women, as specified in s. 46.95, Stats., serving 20 or less occupants as specified in s. Comm 61.001 (3);

Note: See chs. Comm 20-25, Uniform Dwellings for requirements regarding one- and 2-family dwellings. The requirements of chs. Comm 20-25 also apply to newly constructed community-based residential facilities serving 3 to 8 unrelated adults.

Note: See ch. DWD 301, for requirements regarding migrant labor camps.
History: Cr. Register, December, 1981, No. 312, eff. 1-1-82; am. Register, October, 1982, No. 322, eff. 11-1-82; am. (1), Register, December, 1983, No. 336, eff. 1-1-84; cr. (2) (i), Register, August, 1985, No. 356, eff. 1-1-86; r. and recr. (1), am. (2) (intro.), Register, April, 1994, No. 460, eff. 5-1-94; am. (1) and (2) (g) to (i), cr. (2) (j), Register, March, 1995, No. 471, eff. 4-1-95; r. (1) (c), Register, June, 1996, No. 486, eff. 7-1-96; am. (1) (intro.), cr. (1) (k), r. (2) (a), (c), (i) and (j), renum. (2) (b) to (h) to be (2) (a) to (f), Register, September, 2000, No. 537, eff. 10-1-00.

Comm 57.01 Construction. (1) GENERAL. For the purpose of determining the maximum height and area of buildings and structures within the scope of this chapter, the building construction shall be classified in accordance with the construction standards as specified in s. Comm 51.03.

Note: See ss. HFS 83.41 to 83.65, Wis. Adm. Code, for additional construction requirements pertaining to community-based residential facilities.

(2) LIVING UNIT SEPARATION. (a) Each living unit, except rowhouse units as specified in s. Comm 57.19, shall be separated from other living units, common use areas and from the exit access by construction protected with at least the equivalent of one layer of 5/8-inch Type X gypsum wallboard with taped joints.

1. The fire-protective membrane shall be provided on both sides of walls and on the ceiling beneath the floor construction providing the separation. The membrane shall be fastened to the framing or suspended in the manner as required for one-hour fire-resistive rated assemblies.

2. The membrane protection may be omitted on the ceiling of the top-most story if firestopping as specified in s. Comm 51.02 (24) is provided at the intersection of the living unit separation walls and the roof.

Note: See s. Comm 51.03 for building elements required to have fire-resistive ratings to satisfy class of construction standards.

3. a. The annular space around ducts, pipes, and conduits or other penetrating items that penetrate fire-protective membranes required under this paragraph shall be protected as specified in s. Comm 51.049.

b. For the purpose of protecting the annular spaces under subd. 3. a., the methods of protection shall be the same as the membranes for at least a one-hour rated assembly.

Note: This section is intended to apply to living unit separations only. The design and construction of required fire-resistive rated construction for stairway enclosures, hazardous occupancy separations, exit corridors, isolation of hazards enclosures, vertical division walls, fire division walls and other rated construction is governed by ss. Comm 51.043 to 51.046.

(b) Doors separating one hotel or motel living unit from another shall have a $\frac{3}{4}$ -hour fire-resistive rating. Where 2 doors are provided in one frame, only one of the doors is required to be rated. The connecting doors are not required to be equipped with self-closing devices.

(3) **BASEMENT AND GROUND FLOOR PROTECTION.** (a) Except as provided in par. (b), the ceiling of all spaces, except those within individual living units and crawl spaces located below the first story of all residential buildings, shall be protected with at least the equivalent of one layer of $\frac{5}{8}$ -inch type X gypsum wallboard with taped joints.

(b) This subsection shall not apply to buildings where such spaces are protected by an approved automatic sprinkler system.

(4) **GARAGE SEPARATIONS.** A residential occupancy shall be separated from a storage garage or repair garage in accordance with s. Comm 51.08.

History: Cr. Register, December, 1981, No. 312, eff. 1-1-82; am. (4) (b) and (c), cr. (4) (d), Register, December, 1983, No. 336, eff. 1-1-84; r. and recr. (2), Register, August, 1985, No. 356, eff. 1-1-86; am. (2) (a) 2. and (3) (a), r. and recr. (4), Register, March, 1991, No. 423, eff. 4-1-91; cr. (2) (b), Register, January, 1994, No. 457, eff. 2-1-94; emerg. cr. (2) (a) 3., eff. 1-28-98; cr. (2) (a) 3., Register, September, 1998, No. 513, eff. 10-1-98; am. (2) (a), Register, March, 2000, No. 531, eff. 4-1-00; corrections in (2) (a) 2. and 3. b. were made under s. 13.93 (2m) (b) 7., Stats., Register, March, 2000, No. 531.

Comm 57.015 Height of first floor above grade for sheltered facilities for battered women. The elevation of the first floor and the sills of all required exit discharges from the first floor for existing buildings to be converted to sheltered facilities for battered women shall be at or not more than 6 feet above an exit discharge grade.

History: Cr. Register, December, 1983, No. 336, eff. 1-1-84.

Comm 57.016 Automatic fire sprinkler protection. A building more than 60 feet in height shall be protected throughout the entire building in accordance with ss. Comm 52.01 and 51.23, except that the sprinklers within the living units shall be residential type conforming to NFPA 13R, installed in accord with the recommendations and requirements of the manufacturer.

History: Emerg. cr. eff. 9-6-86; cr. Register, November, 1986, No. 371, eff. 12-1-86; r. and recr. Register, March, 1991, No. 423, eff. 4-1-91; am. (1) and (2) (b), Register, January, 1994, No. 457, eff. 2-1-94; renum. (1) to be Comm 57.016, r. (2), Register, June, 1996, No. 486, eff. 7-1-96.

Comm 57.02 Allowable height and area. (1) GENERAL. Buildings and structures within the scope of this chapter shall not exceed the height and area limitations specified in this section.

(2) **ALLOWABLE INCREASE IN FLOOR AREAS.** (a) *Limited area ch. Comm 57 buildings.* 1. Chapter Comm 57 buildings not protected by automatic fire sprinkler systems as specified in s. Comm 57.016 may not exceed the height and area limitations specified in Table 57.02-1.

2. A building may not exceed the height and area limitations specified in Table 57.02-2 if the building is protected by an automatic fire sprinkler system conforming with NFPA 13R.

Note: NFPA standard 13R applies only to buildings 4 stories or less in height.

3. A building may not exceed the height and area limitations specified in Table 57.02-3 if the building is protected by an auto-

matic fire sprinkler system conforming with NFPA 13, except that the sprinklers within the living units shall be residential type conforming to NFPA 13R, installed in accord with the recommendations and requirements of the manufacturer.

(b) *Vertical division wall separations.* 1. No building shall be limited in area when divided into sections which do not exceed the maximum areas tabulated in this section by vertical division walls. Such vertical division walls shall extend from the foundation or the first floor level if the floor construction and supporting elements are of 3-hour rated non-combustible construction, to the underside of the roof deck and shall have at least the following fire-resistive ratings:

- a. 2-hour for type 4, 5A, 5B, 7 and 8 construction;
- b. NC-2 hour for type 3 and 6 construction; and
- c. NC-3 hour for type 1 and type 2 construction.

2. All openings in such walls shall be protected by fire-rated door assemblies as specified in s. Comm 51.047. The doors protecting openings in such walls located in public corridors shall be held open and equipped with an automatic closing device activated by products of combustion other than heat.

(c) *Street access for unlimited area buildings.* 1. Streets shall be within 50 feet of the adjacent building side with no obstructions between the street and the building which will impede fire-fighting efforts.

Note: See s. Comm 51.01 (124) for definition of street.

2. a. Buildings with no area limitations as permitted under Table 57.02-3, shall have a continuous all-weather, hard-surfaced area 30 feet or more in width for a distance of not less than 50% of the perimeter of the building. These buildings shall have at least one wall facing a street for its entire length. At least 2 of the remaining building walls shall face streets for at least 50% of their respective lengths.

b. Unlimited area buildings of fire-resistive type 1 construction and one-story unlimited area buildings of fire-resistive type 2 construction shall be provided with street access as defined in s. Comm 51.01 (124) to at least one side of the building.

(3) **ACCESS ROADWAYS FOR FIRE APPARATUS.** (a) Buildings shall be accessible to fire department apparatus by means of streets as specified in s. Comm 51.01 (124) or access roadways. Access roadways shall be at least 20 feet in width, be capable of supporting the imposed loads of the fire apparatus and have a minimum of 13 feet 6 inches in vertical clearance.

1. For buildings 3 stories or less in height, the street or access roadway shall:

a. Be located within 150 feet of all portions of the exterior walls of the first story as measured along the perimeter of the building; or

b. Extend along at least one entire side of the building which constitutes at least 25% of the total building perimeter with the road edge closest to the building located at least 10 feet but not more than 50 feet from the building.

2. For buildings more than 3 stories in height, the street or access roadway shall extend along at least one entire side of the building which constitutes at least 25% of the total building perimeter with the road edge closest to the building at least 10 feet but not more than 50 feet from the building.

(b) The required streets and access roadways shall be kept free at all times of all obstructions, including parked vehicles and snow.

History: Cr. Register, December, 1981, No. 312, eff. 1-1-82; am. (2) (b) 2., cr. (3), Register, December, 1983, No. 336, eff. 1-1-84; am. (3) (a) 1., Register, August, 1985, No. 356, eff. 1-1-86; emerg. am. (1), r. and recr. (2), r. table 57.02, cr. tables 57.02-1, 57.02-2 and 57.02-3, eff. 9-6-86; am. (1), r. and recr. (2), r. table 57.02, cr. tables 57.02-1, 57.02-2 and 57.02-3, Register, November, 1986, No. 371, eff. 12-1-86; cr. (2) (c) 2. b., r. and recr. (2) (a) 2. and 3., renum. and am. (2) (c) 2. to (2) (c) 2. a., am. (3) (a) 1. a. and 2., Register, March, 1991, No. 423, eff. 4-1-91; reprinted to restore text in (3) (a), Register, June, 1991, No. 426, eff. 7-1-91; am. (2) (a) 3., (b) 1. c., and table 57.02-2, Register, January, 1994, No. 457, eff. 2-1-94.

TABLE 57.02-1 — ALLOWABLE HEIGHT (STORIES) AND AREA (SQUARE FEET) FOR BUILDINGS WITHOUT COMPLETE AUTOMATIC FIRE SPRINKLER SYSTEM PROTECTION (MAXIMUM GROSS FLOOR AREA PER FLOOR)
NOTE: DO NOT USE FOR BUILDINGS EXCEEDING 60 FEET IN HEIGHT

CLASS OF CONSTRUCTION	OPEN SPACE AT LEAST 30 FEET IN WIDTH OR STREET WITHIN 50 FEET OF BUILDING	THE NUMBER OF STORIES								
		1	2	3	4	5	6	7	8	Over 8
1. Fire-Resistive Type A	1	19,800	17,000	14,800	12,500	10,300	8,800	7,300	6,500	5,300
	2	23,900	20,800	18,500	15,900	13,600	11,800	10,300	9,500	8,300
	3	28,000	25,300	22,300	19,300	17,000	14,800	13,300	12,500	11,300
	4	32,100	29,800	26,000	22,600	20,400	17,800	16,300	15,500	14,300
2. Fire-Resistive Type B	1	17,800	15,000	12,800	10,500	8,300	6,800	5,300	4,500	
	2	21,900	18,800	16,500	13,900	11,600	9,800	8,300	7,500	N.P.
	3	26,000	23,300	20,300	17,300	15,000	12,800	11,300	10,500	
	4	30,100	27,800	24,000	20,600	18,400	15,800	14,300	13,500	
3. Metal Frame Protected	1	15,800	13,500	11,300	9,000					
	2	19,900	17,300	14,600	12,000	N.P.	N.P.	N.P.	N.P.	N.P.
	3	24,000	21,000	18,000	15,000					
	4	28,100	24,800	21,400	18,000					
4. Heavy Timber	1	12,800	10,500	7,400	6,800					
	2	16,500	14,300	12,000	10,100	N.P.	N.P.	N.P.	N.P.	N.P.
	3	20,300	18,000	15,800	13,500					
	4	24,000	21,800	19,500	16,900					
5A. Exterior Masonry Protected	1	11,600	9,600	7,200	6,000					
	2	15,000	12,800	10,700	8,800	N.P.	N.P.	N.P.	N.P.	N.P.
	3	18,400	16,100	13,900	11,600					
	4	21,800	19,500	17,100	14,500					
5B. Exterior Masonry Unprotected	1	10,500	8,600	6,800						
	2	13,500	11,300	9,400	N.P.	N.P.	N.P.	N.P.	N.P.	N.P.
	3	16,500	14,300	12,000						
	4	19,500	17,300	14,600						
6. Metal Frame Unprotected	1	10,500	8,600	6,800						
	2	13,500	11,300	9,400	N.P.	N.P.	N.P.	N.P.	N.P.	N.P.
	3	16,500	14,300	12,000						
	4	19,500	17,300	14,600						
7. Wood Frame Protected	1	10,500	8,600	6,800						
	2	13,500	11,300	9,400	N.P.	N.P.	N.P.	N.P.	N.P.	N.P.
	3	16,500	14,300	12,000						
	4	19,500	17,300	14,600						
8. Wood Frame Unprotected	1	7,500	3,800							
	2	9,000	4,500	N.P.	N.P.	N.P.	N.P.	N.P.	N.P.	N.P.
	3	10,500	5,300							
	4	12,000	6,000							

N.P. MEANS NOT PERMITTED

TABLE 57.02-2 — ALLOWABLE HEIGHT (STORIES) AND AREA (SQUARE FEET) FOR BUILDINGS PROTECTED IN ACCORDANCE WITH NFPA 13R (MAXIMUM GROSS FLOOR AREA PER FLOOR) NOTE: USE FOR ALL BUILDINGS

CLASS OF CONSTRUCTION	OPEN SPACE AT LEAST 30 FEET IN WIDTH OR STREET WITHIN 50 FEET OF BUILDING	THE NUMBER OF STORIES								
		1	2	3	4	5	6	7	8	Over 8
		1. Fire-Resistive Type A	1	39,600	34,000	29,600	25,000	N.A.	N.A.	N.A.
	2	47,800	41,600	37,000	31,800					
	3	56,000	50,600	44,600	38,600					
	4	64,200	59,600	52,000	45,200					
2. Fire-Resistive Type B	1	35,600	30,000	25,600	21,000	N.A.	N.A.	N.A.	N.A.	N.A.
	2	43,800	37,600	33,000	27,800					
	3	52,000	46,600	40,600	34,600					
	4	60,200	55,600	48,000	41,200					
3. Metal Frame Protected	1	31,600	27,000	22,600	18,000	N.P.	N.P.	N.P.	N.P.	N.P.
	2	39,800	34,600	29,200	24,000					
	3	48,000	42,000	36,000	30,000					
	4	56,200	49,600	42,800	36,000					
4. Heavy Timber	1	25,600	21,000	14,800	13,600	N.P.	N.P.	N.P.	N.P.	N.P.
	2	33,000	28,600	24,000	20,200					
	3	40,600	36,000	31,600	27,000					
	4	48,000	43,600	39,000	33,800					
5A. Exterior Masonry Protected	1	23,200	19,200	14,400	12,000	N.P.	N.P.	N.P.	N.P.	N.P.
	2	30,000	25,600	21,400	17,600					
	3	36,800	32,200	27,800	23,200					
	4	43,600	39,000	34,200	29,000					
5B. Exterior Masonry Unprotected	1	21,000	17,200	13,600	N.P.	N.P.	N.P.	N.P.	N.P.	N.P.
	2	27,000	22,600	18,800						
	3	33,000	28,600	24,000						
	4	39,000	34,600	29,200						
6. Metal Frame Unprotected	1	21,000	17,200	13,600	N.P.	N.P.	N.P.	N.P.	N.P.	N.P.
	2	27,000	22,600	18,800						
	3	33,000	28,600	24,000						
	4	39,000	34,600	29,200						
7. Wood Frame Protected	1	21,000	17,200	13,600	N.P.	N.P.	N.P.	N.P.	N.P.	N.P.
	2	27,000	22,600	18,800						
	3	33,000	28,600	24,000						
	4	39,000	34,600	29,200						
8. Wood Frame Unprotected	1	15,000	7,600	N.P.	N.P.	N.P.	N.P.	N.P.	N.P.	N.P.
	2	18,000	9,000							
	3	21,000	10,600							
	4	24,000	12,000							

N.P. MBANS NOT PERMITTED; N.A. MEANS NOT APPLICABLE

TABLE 57.02-3 — ALLOWABLE HEIGHT (STORIES) AND AREA (SQURE FEET) FOR BUILDINGS PROTECTED IN ACCORDANCE WITH NFPA 13 (MAXIMUM GROSS FLOOR AREA PER FLOOR) NOTE:USE FOR ALL BUILDINGS

CLASS OF CONSTRUCTION	OPEN SPACE AT LEAST 30 FEET IN WIDTH OR STREET WITHIN 50 FEET OF THE BUILDING	NUMBER OF STORIES									
		1	2	3	4	5	6	7	8	9	Over 9
1. Fire-resistive Type A stories and area may be unlimited subject to s. Comm 57.02 (2) (c)	1				NO	LIMIT					
	2										
	3										
	4										
2. Fire-resistive type B 1 to 9 story area may be unlimited subject to s. Comm 57.02 (2) (c)	1		53,400	45,000	38,400	31,500	24,900	20,400	15,900	13,500	N.P.
	2	NO	65,700	56,400	49,500	41,700	34,800	29,400	24,900	22,500	
	3	LIMIT	78,000	69,900	60,900	51,900	45,000	38,400	33,900	31,500	
	4		90,300	83,400	72,000	61,800	55,200	47,400	42,900	40,500	
3. Metal frame protected 1 to 5 story area may be unlimited subject to s. Comm 57.02 (2) (c)	1		63,200	47,400	40,500	33,900	27,000	N.P.	N.P.	N.P.	N.P.
	2		79,600	59,700	51,900	43,800	36,000				
	3		96,000	72,000	63,000	54,000	45,000				
	4		112,400	84,300	74,400	64,200	54,000				
4. Heavy Timber 1 to 3 story area may be unlimited subject to s. Comm 57.02 (2) (c)	1		51,200	38,400	31,500	22,200	20,400	N.P.	N.P.	N.P.	N.P.
	2		66,000	49,500	42,900	36,000	30,300				
	3		81,200	60,900	54,000	47,400	40,500				
	4		96,000	72,000	65,400	58,500	50,700				
5A. Exterior Masonry Protected 1 to 3 story area may be unlimited subject to s. Comm 57.02 (2) (c)	1		46,400	34,800	28,800	21,600	16,000	N.P.	N.P.	N.P.	N.P.
	2		60,000	45,000	38,400	32,100	26,400				
	3		73,600	55,200	48,300	41,700	34,800				
	4		87,200	65,400	58,500	51,300	43,500				
5B. Exterior Masonry Unprotected 1 story area may be unlimited subject to s. Comm 57.02 (2) (c)	1		42,000	31,500	25,800	20,400	N.P.	N.P.	N.P.	N.P.	N.P.
	2		54,000	40,500	33,900	28,200					
	3		66,000	49,500	42,900	36,000					
	4		78,000	58,500	51,900	43,800					
6. Metal Frame Unprotected 1 story area may be unlimited subject to s. Comm 57.02 (2) (c)	1		42,000	31,500	25,800	20,400	N.P.	N.P.	N.P.	N.P.	N.P.
	2		54,000	40,500	33,900	28,200					
	3		66,000	49,500	42,900	36,000					
	4		78,000	58,500	51,900	43,500					
7. Wood Frame Protected	1		42,000	31,500	25,800	20,400	N.P.	N.P.	N.P.	N.P.	N.P.
	2		54,000	40,500	33,900	28,200					
	3		66,000	49,500	42,900	36,000					
	4		78,000	58,500	51,900	43,800					
8. Wood Frame Unprotected	1		30,000	22,500	11,400	N.P.	N.P.	N.P.	N.P.	N.P.	N.P.
	2		36,000	27,000	13,500						
	3		42,000	31,500	15,900						
	4		48,000	36,000	18,000						

N.P. MEANS NOT PERMITTED

Comm 57.03 Number and location of exits. (1) NUMBER OF EXITS. (a) Except as provided in par. (b), all living units shall have exits or exit accesses in accordance with one of the following:

1. The unit shall have at least one exit access door into a common area of the building arranged such that there are 2 directions of travel from the unit's exit access door leading to separate exits;

2. The unit shall be provided with 2 separate exits contained within the unit;

3. The unit shall be provided with 2 exit access doors into separate common areas, with each common area provided with at least one exit; or

4. The unit shall be provided with an exit access door into a common area with at least one exit, in addition to an exit contained within the unit.

(b) Units with habitable rooms on a floor of exit discharge may be provided with at least one exit, directly from the unit to the exte-

rior, with the unit exit door sill at or within 6 feet of grade at the exit door.

(c) A minimum of 2 exits or exit access doors shall be provided from any living unit which accommodates more than 8 people.

(2) **EXIT DISTRIBUTION.** The number and location of exits shall be such that in case any exit or passageway is blocked at any point, some other exit will still be accessible through public passageways from every living unit.

(3) **DISTANCE TO EXIT.** (a) 1. Exits shall be distributed so that the entrance to each living unit will be not more than 100 feet distant from an exit, measuring along public passageways.

Note: Also see s. Comm 57.08 (2).

2. Where automatic fire sprinkler system protection as specified in s. Comm 57.016 is provided an increase in exit distance to 150 feet will be permitted.

(b) The exit distances required by this section shall be measured to exits to grade, to doors leading to stairway enclosures as specified in ss. Comm 51.165, 51.17 and 51.18, or to horizontal exits as specified in s. Comm 51.19.

(4) **EXITS FOR NONRESIDENTIAL PORTIONS OF BUILDINGS.** Exits serving portions of buildings without sleeping rooms or living units (i.e., basements of apartment buildings, hotel lobbies, and similar areas) shall be provided in accordance with the appropriate occupancy chapter, chs. Comm 54 to 62, which may govern.

(5) **DIRECTIONS FOR ESCAPE.** An exiting diagram shall be conspicuously posted in every habitable room to be used by transients, including but not limited to those habitable rooms of hotels, motels, rooming houses and dormitories. The exit diagram shall depict the location of the room with respect to other rooms and at least 2 exits.

History: Cr. Register, December, 1981, No. 312, eff. 1-1-82; am. (1), Register, August, 1985, No. 356, eff. 1-1-86; emerg. renum. (2) (a) to be (2) (a) 1., cr. (2) (a) 2., eff. 9-6-86; renum. (2) (a) to be (2) (a) 1., cr. (2) (a) 2., Register, November, 1986, No. 371, eff. 12-1-86; r. and recr. (1) (a) and (b) and (5), renum. (2) to (5) to be (3), (2), (5), and (4) and am. (4), Register, March, 1991, No. 423, eff. 4-1-91; am. (1) (b), Register, January, 1994, No. 457, eff. 2-1-94; correction in (3) (a) 2. made under s. 13.93 (2m) (b) 7, Stats., Register, January, 1994, No. 457.

Comm 57.04 Capacity of buildings and exits.

(1) **BUILDINGS.** (a) *Sleeping areas.* The capacity of the habitable rooms of the living units of the building, other than a community-based residential facility, shall be established as follows:

1. 400 cubic feet for each occupant over 12 years of age; and
2. 200 cubic feet for each occupant 12 years of age or under.

(b) *Minimum size.* The size of habitable rooms shall provide the minimum volumes specified in par. (a).

(c) *Nonsleeping areas.* The capacity of the areas not within the living units of the building shall be established as specified in s. Comm 54.05 or 55.06.

(d) *Overcrowding.* The number of occupants permitted in any room or in the building shall not exceed the capacities specified in this section.

(2) **COMMUNITY-BASED RESIDENTIAL FACILITIES.** (a) *Facilities serving 9 to 20 residents.* The minimum size of resident bedrooms in community-based residential facilities serving 9 to 20 residents shall be as follows:

1. Sixty square feet of habitable floor space per ambulatory resident;
2. Eighty square feet of habitable floor space per semiambulatory or nonambulatory resident in multiple bed sleeping rooms; and
3. One hundred square feet of habitable floor space per semiambulatory or nonambulatory resident in single bed sleeping room.

(b) *Facilities serving more than 20 residents.* The minimum size of resident bedrooms in community-based residential facilities serving more than 20 residents shall be as follows:

1. Eighty square feet of habitable floor space per ambulatory resident;

2. Eighty square feet of habitable floor space per semiambulatory and nonambulatory resident in multiple bed sleeping rooms; and

3. One hundred square feet of habitable floor space per semiambulatory and nonambulatory resident in single bed sleeping rooms.

(c) *Nonsleeping rooms.* In addition to the floor areas required under pars. (a) and (b), a community-based residential facility shall provide habitable floor space, other than sleeping rooms of not less than:

1. Sixty square feet in area for each ambulatory resident;
2. Ninety square feet in area for each semiambulatory resident; and
3. Ninety square feet in area for each nonambulatory resident.

(3) **EXITS.** The total required exit width from each level of the building shall be as specified in ss. Comm 51.15 (6) and 51.16 (3).

History: Cr. Register, December, 1981, No. 312, eff. 1-1-82; cr. (2) (c), Register, March, 1991, No. 423, eff. 4-1-91.

Comm 57.05 Type of exits. (1) **GENERAL.** Except as provided in sub. (2), at least one-half of the required exits, accessible from each living unit, shall be exits to grade or stairways as specified in ss. Comm 51.15 and 51.16. The remaining exits shall be either stairways, interior enclosed stairways, exits to grade or horizontal exits. Fire escapes placed against blank walls may be used as exits from floors which are not more than 40 feet above grade.

(2) **EXCEPTIONS.** (a) Every building which accommodates more than one family, or 8 persons, above the second story shall have at least 2 stairways.

(b) A rescue platform of combustible construction may be used as a required second exit for buildings of type 5 through type 8 construction, provided the following conditions are satisfied:

1. The exit serves a single living unit;
2. The exit platform is located not more than 15 feet above the adjacent exit discharge grade;
3. The platform area is at least 14 square feet, with a minimum dimension of 3 feet;
4. The platform is designed for 80 pounds per square foot live load plus dead load;
5. Railings are provided as specified in s. Comm 51.162;
6. Platforms having solid floors are provided with a roof equal in area to that of the platform;
7. All wood used in the construction of the rescue platform shall be pressure treated wood satisfying the requirements of the applicable standards specified in s. Comm 53.63 (6) unless the wood is inherently resistant to decay; and
8. The building is not a residential care facility or group foster home.

History: Cr. Register, December, 1981, No. 312, eff. 1-1-82; am. (2) (b) (intro.) and 6., renum. (2) (b) 7. to be (2) (b) 8., cr. (2) (b) 7., Register, December, 1983, No. 336, eff. 1-1-84; am. (2) (b) (intro.) and 7., Register, March, 1991, No. 423, eff. 4-1-91; am. (2) (b) 2., Register, March, 1995, No. 471, eff. 4-1-95; am. (2) (b) 8., Register, June, 1996, No. 486, eff. 7-1-96.

Comm 57.06 Doors. (1) **EXIT DOORS.** Exit doors shall be as specified in s. Comm 51.15, except:

(a) Sliding glazed patio-type doors may serve as the second exit from individual living units, provided there is a means to prevent accumulation of snow and ice in the door track or freezing of the door; and

(b) A door which is used by not more than 25 persons is not required to swing in the direction of egress.

(2) **OPENINGS INTO CORRIDORS.** All doors from living units opening into public exit access corridors shall be protected by at

least 20-minute labeled fire-door assemblies. Such doors shall be self-closing.

(3) ACCESS DOORS. Exit access doors from individual living units shall be at least 3 feet 0 inches in width.

History: Cr. Register, December, 1981, No. 312, eff. 1-1-82; r. and recr. (1), am. (2), cr. (3), Register, March, 1991, No. 423, eff. 4-1-91.

Comm 57.07 Steps, stairs and shafts. (1) EXTERIOR STAIRS. Exterior stairs shall be as specified in s. Comm 51.16, except that less than 3 steps may be provided between exterior platforms and grade serving only apartments, row houses and town houses, and the platforms or treads between such risers do not exceed 5 feet 0 inches in length in the direction of travel.

(2) INTERIOR STAIRS. Interior stairs shall be as specified in s. Comm 51.16, except those used by up to 25 people shall have a width of at least 3 feet.

(3) CHANGES OF ELEVATION WITHIN INDIVIDUAL LIVING UNITS. (a) Changes of elevation within the living unit shall be overcome by means of steps, stairs or ramps and shall be as specified in s. Comm 21.04, except a spiral stairway as specified in s. Comm 51.16 (7) may serve as the only exit from floor levels within an individual living unit, if the floor level served is no larger than 400 square feet in net area.

Note: See appendix for a reprint of s. Comm 21.04.

(b) A spiral stairway as specified in s. Comm 51.16 (7) may serve as the only exit from floor levels within an individual living unit, if the floor level served is no larger than 400 square feet.

History: Cr. Register, December, 1981, No. 312, eff. 1-1-82; r. and recr. (3), Register, August, 1985, No. 356, eff. 1-1-86; r. and recr. (3) (a), Register, March, 1991, No. 423, eff. 4-1-91; renum. (2) to be (2) (a), cr. (2) (b), Register, April, 1994, No. 460, eff. 5-1-94; r. and recr. (2), Register, September, 2000, No. 537, eff. 10-1-00.

Comm 57.08 Enclosure of interior stairways and shafts. (1) APPLICATION. Except as provided in sub. (2), all stairways, including landings, ramps and shafts, shall be enclosed as specified in s. Comm 51.02 (11) with fire-resistive rated construction as specified in Table 51.03-A.

(2) EXCEPTIONS. (a) The exit access stairway or shaft connecting the first and second floor in residential buildings 2 stories or less in height may be left open in the following applications providing the conditions specified in par. (b) are satisfied:

1. Buildings having not more than 4 individual living units per floor each of which is served by 2 or more means of egress; or

2. A building which is used as a rooming house, dormitory or congregate living facility and which has a maximum occupancy limit of 16 persons per floor.

(b) 1. Every exit access stairway or shaft to the basement or ground floor is cut off at the first floor or first adjacent basement or ground floor level with fire resistive construction as specified in Table 51.03-A or better; and

2. The distance to an exit, including the horizontal travel distance on the exit stair, does not exceed 50 feet in buildings not completely protected with an automatic fire sprinkler system or 75 feet in buildings completely protected as specified in s. Comm 57.016.

History: Cr. Register, December, 1981, No. 312, eff. 1-1-82; am. Register, October, 1982, No. 322, eff. 11-1-82; emerg. am. (2) (b) 2., eff. 9-6-86; am. (2) (b) 2., Register, November, 1986, No. 371, eff. 12-1-86; r. and recr. (2) (a) 2., Register, March, 1991, No. 423, eff. 4-1-91; correction in (2) (b) 2. made under s. 13.93 (2m) (b) 7., Stats., Register, December, 1996, No. 492.

Comm 57.09 Passageways. (1) WHERE REQUIRED. Where there is not direct access to outside exit doors, safe and continuous passageways, aisles or corridors leading directly to every exit shall be maintained at all times on all floors of all buildings.

(2) MINIMUM WIDTH. Every public passageway leading from an exit shall be at least as wide as the required width of the exit as specified in s. Comm 51.15 (6), but in no case shall the width be less than 3 feet.

(3) WIDTH DETERMINATION. Widths shall be measured in the clear, at their narrowest points produced by any projection, radiator, pipe or other object.

(4) MAINTENANCE. The required width shall be kept clear and unobstructed at all times.

History: Cr. Register, December, 1981, No. 312, eff. 1-1-82.

Comm 57.10 Illumination of exits and exit signs.

(1) ILLUMINATION. (a) Buildings having more than 4 living units or accommodating more than 30 persons or accommodating transients shall have public passageways, stairways and exit doors illuminated from one hour after sunset to one hour before sunrise.

(b) The illumination requirements specified in par. (a) shall be provided at all intersections or passageways, at all exits and at the head, foot and landing of every stairway.

(2) EXIT LIGHTS. (a) Except as provided in par. (b), every required exit, from each floor shall be indicated by an approved illuminated, exit sign.

(b) 1. Exits within an individual living unit need not be provided with exit signs.

2. Exits in buildings having 4 living units or less per floor need not be provided with exit signs if the building contains not more than 8 living units and the path of exit from all floor levels including the basement to the outside is readily apparent.

(c) Exit lights shall be as specified in s. Comm 51.15 (5).

History: Cr. Register, December, 1981, No. 312, eff. 1-1-82; am. (2), Register, December, 1983, No. 336, eff. 1-1-84; am. (2) (c), Register, January, 1994, No. 457, eff. 2-1-94.

Comm 57.11 Habitable rooms with floors below grade. (1) GENERAL. Living units in residential buildings having habitable rooms or parts on floor levels below grade shall comply with the following:

(a) The grade at the building does not include the grade level within the perimeter of an areaway;

(b) Every habitable room shall have at least one exterior wall adjoining an areaway or court;

(c) Every habitable room shall have at least one outside window which can be opened from the inside without the use of tools to provide a clear opening of not less than 20 inches in width, 24 inches in height, and 5.7 square feet in area, with the bottom of the opening not more than 44 inches above the floor.

(d) All living units with floors below grade shall have access to 2 exits complying with s. Comm 57.05, except living units having one exit door leading directly outside and not to an areaway need not have access to a second exit.

(2) AREAWAYS. Areaways used as specified in this section shall:

(a) Be $1\frac{1}{2}$ times the depth to the bottom of the opening with a minimum width of 3 feet measured perpendicular to the building wall; and

Note: See s. Comm 64.07 for additional requirements.

(b) Have stairway exits complying with ss. Comm 51.16 and 52.21, when used as a required exit.

(4) MOISTURE PROTECTION. All buildings having living units below grade shall be designed and constructed to prevent undue collection of moisture in all stories below grade.

Note: Surface and subsoil drainage systems for areaways and foundation walls are regulated under the requirements of ch. Comm 82.

Note: See s. Comm 50.07 (2) Note 3 for reference to flood plain requirements.

(a) All foundation walls shall be thoroughly damp proofed prior to backfilling of soil.

(b) Provisions shall be made to prevent the accumulation of moisture due to condensation of high humidity so as to prevent slippery floors and to prevent conditions susceptible to mildew or other undesirable fungi or bacteria. The inside design conditions

for cooling or dehumidification shall be on the basis of a dry bulb temperature of 75° F and a relative humidity not greater than 50%.

History: Cr. Register, December, 1981, No. 312, eff. 1-1-82; r. and recr. (1) (c), r. (1) (d) and (e), renum. (1) (f) to be (1) (d), Register, December, 1983, No. 336, eff. 1-1-84; am. (3) (a), Register, January, 1994, No. 457, eff. 2-1-94; renum. (2) to be Comm 66.44 (3), renum. (3) to be (2), Register, June, 1996, No. 486, eff. 7-1-96.

Comm 57.12 Sanitary facilities. (1) TOILET ROOMS. Every building included under the scope of this chapter shall be

provided with separate toilet rooms for each sex, except that a single toilet room to accommodate both sexes may be provided in individual living or sleeping units.

(2) SANITARY FIXTURES. (a) Residents. The number of sanitary fixtures required for each sex shall be determined in accordance with the numbers and ratios established in Table 57.12.

**TABLE 57.12
NUMBER OF SANITARY FIXTURES REQUIRED FOR
RESIDENTIAL OCCUPANCIES**

Type of Occupancy	Type of Fixture					
	Water Closets (WC)		Urinals (U)	Drinking Facilities (DF)	Lavatories (L)	Bathtubs or Showers (S)
	Males (M)	Females (F)				
With individual unit toilet rooms	One for each living unit		0	0	One for each living unit	One for each living unit
With communal use sanitary facilities	One for each 10 (M), or fraction; one for each 10 (F), or fraction		Urinals may be substituted for up to 2/3 required (WC) for (M)	One for each 100 persons	One for each 10 persons	One for each 20 persons

¹For structures with additions or alterations, the required number of sanitary fixtures shall be the sum of the fixtures required for the existing portion at the time it was constructed plus the fixtures required by this table for the new addition or altered area. At such time as the summation of the addition/alteration area is equal to or greater than 51% of the building area calculated as specified in s. Comm 50.03 (4) (d), fixtures shall be provided in conformance to this table utilizing the capacity of the entire building.

²Where a single toilet room designated as UNISEX is provided, it shall be considered as accommodating no more than 10 employees and 25 occupants.

(b) Employees. Sanitary facilities for employees who do not sleep in the building shall be provided as specified in Table 54.12-A, unless the employees have access to the sanitary facilities provided for the residents during all shifts.

(c) General public. Sanitary facilities for the general public shall be provided as specified in Table 54.12-A or Table 54.12-B, unless the general public has access to the facilities provided for the residents.

(3) FOOD PREPARATION. One kitchen sink, equipped with hot and cold running water, shall be provided in living units equipped for food preparation.

History: Cr. Register, December, 1981, No. 312, eff. 1-1-82; r. and recr., Register, August, 1993, No. 452, eff. 3-1-94.

Comm 57.13 Windows. (1) LIGHT. (a) Every habitable room shall be provided with natural light by means of glazed openings.

1. Glazed openings shall consist of windows or skylights or a combination of the two.

2. The area of glazed openings shall equal at least 8% of the floor area of the room served.

3. Glazed openings serving habitable rooms shall view onto the outside, except the glazed openings may obtain borrowed light from naturally lighted pool or recreational areas to serve:

- Habitable rooms in motels and hotels, or
- Other similar sleeping rooms accommodating transients.

(2) VENTILATION. (a) Except as provided in par. (b), every habitable room shall be provided with natural ventilation by means of openable doors or windows. The openable amount of such doors and windows shall be at least 4% of the floor area of the room.

(b) Habitable rooms in motels and hotels and similar sleeping rooms in buildings accommodating transients shall not be required to be provided with openable doors and windows for ventilation purposes if the rooms are provided with mechanical ventilation systems supplying tempered outside air and air movement as specified in ss. Comm 64.05 and 64.06.

Note: Section Comm 57.13 was revised in December, 1995, effective April 1, 1996. On April 6, 1996 the department of industry, labor and human relations published an emergency rule stating that the effective date of the December, 1995 rule

revision was delayed. A permanent rule was adopted in December, 1996 stating that the revised text of s. Comm 57.13, as published, would be effective April 1, 1997.

History: Cr. Register, December, 1981, No. 312, eff. 1-1-82; am. (1) (a), Register, October, 1982, No. 322, eff. 11-1-82; am. (1) (a), Register, August, 1985, No. 356, eff. 1-1-86; r. and recr., Register, March, 1991, No. 423, eff. 4-1-91; am. (1) (a) 2., January, 1994, No. 457, eff. 2-1-94; emerg. am. (2) (b), eff. 8-14-95; am. (2) (b), Register, December, 1995, No. 480, eff. 4-1-96; am. (2) (b), Register, December, 1996, No. 492, eff. 4-1-97.

Comm 57.145 Occupancy separations and hazard enclosures. Occupancies within the scope of this chapter shall be separated from other occupancies or uses in accordance with s. Comm 51.08. Hazards shall be enclosed in accordance with s. Comm 51.08.

History: Cr. Register, March, 1991, No. 423, eff. 4-1-91; r. and recr., Register, December, 1995, No. 480, eff. 4-1-96; r. and recr., Register, March, 1997, No. 495, eff. 4-1-97.

Comm 57.15 Fire protection systems. (1) SPRINKLER SYSTEMS. Automatic fire sprinkler systems shall be provided as outlined in ss. Comm 52.01, 52.011, 52.012 and 52.013.

(2) STANDPIPE SYSTEMS. (a) Fire department standpipes. Fire department standpipes shall be provided in all buildings exceeding 60 feet in height.

(b) Dry standpipes. Dry standpipes shall be provided in all buildings 3 stories or more in height which accommodate more than 20 occupants, unless an approved automatic sprinkler system as specified in s. Comm 57.016 is installed. Dry standpipes that are required under this paragraph shall comply with s. Comm 51.21 (3) (b) and (k).

Note: Dry standpipes that are required under this paragraph are required by s. Comm 51.21 (6) (b) to be located within stairway enclosures. Other stairway enclosures may be provided that do not include dry standpipes.

History: Cr. Register, December, 1981, No. 312, eff. 1-1-82; emerg. r. and recr. (2), eff. 9-6-86; r. and recr. (2), Register, November, 1986, No. 371, eff. 12-1-86; r. and recr., Register, March, 1991, No. 423, eff. 4-1-91; am. (2) (b), Register, January, 1994, No. 457, eff. 2-1-94.

Comm 57.16 Smoke detection. (1) NUMBER OF DETECTORS REQUIRED AND LOCATION. (a) All buildings within the scope of this chapter, except CBRF shall be provided with approved smoke detectors as specified in this section.

(b) The owner shall install at least one smoke detector:

- In the basement;

2. At the head of every open stairway;
3. At the door on each floor level leading to every enclosed stairway; and
4. Either in each sleeping area of each living unit or elsewhere in the unit within 6 feet from the doorway of each sleeping area and not within a kitchen.
5. Inside each individual bedroom or sleeping room.

(c) All smoke detectors in stairways, corridors and other public places in the building shall be directly and permanently wired to a proper unswitched circuit.

1. Such detectors shall be connected to the emergency electrical power system, when the system is required by ch. Comm 16.

2. Such detectors shall be electrically interconnected to the required manual fire alarm system. All smoke detectors, which are electrically interconnected to the manual fire alarm system, shall be a latching type, system detector intended for use with a control panel and shall utilize a supervised circuit.

Note: See s. Comm 51.245 for additional requirements pertaining to smoke detectors.

(d) Smoke detectors shall be installed and maintained in accordance with this section and s. Comm 51.245.

Note: Section 101.145 (3), Stats., states: "The owner of a residential building shall install any smoke detector required under this section according to the directions and specifications of the manufacturer of the smoke detector and maintain any smoke detector which is located in a common area of that residential building. The occupant of a unit in a residential building shall maintain any smoke detector in that unit, except that if an occupant who is not an owner, or a state, county, city, village or town officer, agent or employee charged under statute or municipal ordinance with powers or duties involving inspection of real or personal property, gives written notice to the owner that a smoke detector in the unit is not functional the owner shall provide, within 5 days after receipt of that notice, any maintenance necessary to make that smoke detector functional."

Note: Section 101.145 (4), Stats., addresses retroactivity requirements for buildings constructed prior to the effective date of this section. This statute section states: "The owner of a residential building the initial construction of which is commenced before, on or after May 23, 1978, shall install and maintain a functional smoke detector in the basement and at the head of any stairway on each floor level of the building and shall install a functional smoke detector either in each sleeping room of each unit or elsewhere in the unit within 6 feet of each sleeping area and not in a kitchen."

History: Cr. (1), Register, December, 1981, No. 312, eff. 1-1-82; cr. (2), eff. 1-1-83; am. (1) (c) 2., Register, October, 1982, No. 322, eff. 11-1-82, am. (2), eff. 1-1-83; am. (1) (a), Register, August, 1985, No. 356, eff. 9-1-85; r. and recr. (1) (b), cr. (1) (d), Register, April, 1990, No. 412, eff. 5-1-90; correction in (1) (c) 1. made under s. 13.93 (2m) (b) 7., Stats., Register, December, 1996, No. 442; cr. (1) (b) 5., am. (1) (d) and r. (2), Register, March, 2000, No. 531, eff. 4-1-00.

Comm 57.165 Smoke detection for CBRF. (1) GENERAL. All CBRF within the scope of this chapter shall be provided with an approved smoke detection system.

(2) TYPE OF SYSTEM. The smoke detection system specified in sub. (1) shall be at least a low voltage interconnected smoke detection system designed to protect the entire facility and capable of sounding an alarm throughout the facility or at a central location upon actuation of any smoke detector.

(3) SMOKE DETECTOR LOCATION. At least 1 approved interconnected smoke detector shall be provided at the following locations:

- (a) At the head of every open stairway;
- (b) At the door leading to every enclosed stairway on each floor level;
- (c) In every corridor, spaced not more than 30 feet apart and not further than 15 feet from any wall;
- (d) In each common use room, including living rooms, dining rooms, family rooms, lounges and recreation rooms but not including kitchens; and
- (e) In each sleeping room in which smoking is allowed.

(4) APPLICABILITY. The provisions of this section shall apply to all CBRF constructed on or after the effective date of this section and to those CBRF previously constructed.

Note: See s. Comm 51.245 for additional requirements pertaining to smoke detectors.

History: Cr. Register, August, 1985, No. 356, eff 9-1-85.

Comm 57.17 Fire alarms. (1) GENERAL. (a) Except as provided in par. (b), every building, which can accommodate 20 or more persons, as determined by the requirements specified in s. Comm 57.04, shall be provided with a manual fire alarm system as specified in s. Comm 51.24.

(b) Residential occupancies, including hotels and motels, not more than one story in height in which each living unit has a primary swinging exit door at grade level are exempted from the provisions of par. (a).

(2) APPLICATION. This section shall apply to all buildings in existence on the effective date of this section and to those buildings constructed thereafter.

History: Cr. Register, December, 1981, No. 312, eff. 1-1-82; am. (1), Register, October, 1982, No. 322, eff. 11-1-82; am. (1) (b), Register, December, 1983, No. 336, eff. 1-1-84.

Comm 57.18 Fire extinguishers. (1) GENERAL. Portable fire extinguishers shall be provided in buildings more than one story in height. The extinguishers shall be located in the public areas of the building and comply with the requirements of Table 57.18.

Note: See Appendix A for further explanatory material.

Table 57.18

Basic Minimum Extinguisher Rating for Area Specified	Maximum Travel Distance to Extinguishers (feet)	Area to be Protected per Extinguisher (square feet)
2A	75	6,000
3A	75	9,000
4A	75	11,250
6A	75	11,250

(2) LOCATION. (a) Extinguishers shall be conspicuously located where they are readily accessible and immediately available in the event of fire.

(b) Extinguishers shall not be obstructed or obscured from view.

(3) MAINTENANCE. Portable fire extinguishers shall be maintained as specified in s. Comm 51.22.

History: Cr. Register, December, 1981, No. 312, eff. 1-1-82; emerg. am. (1), eff. 9-6-86; am. (1), Register, November, 1986, No. 371, eff. 12-1-86; r. and recr. Table, Register, March, 1991, No. 423, eff. 4-1-91.

Comm 57.19 Rowhouse. (1) VERTICAL OCCUPANCY SEPARATIONS. (a) Each living unit shall be separated from the adjacent living unit by a vertical occupancy separation of not less than one hour fire-resistive construction, extending from the foundation to the underside of the roof deck.

(b) Piercing of the vertical occupancy separation between the units by doors or windows shall be prohibited.

(c) Piercing of the vertical occupancy separation by mechanical, electrical or plumbing elements may be permitted provided the piercing is as specified in s. Comm 51.049 and it does not violate the hourly rating of the wall.

Note: Mechanical, electrical or plumbing systems may be located in the occupancy separation wall and components may penetrate one or both sides of the wall within the same stud space. See s. Comm 51.049 (3) for additional requirements pertaining to plastic components.

(2) EXITS. Each living unit shall have a separate exit within 6 feet of the exit discharge grade.

(3) ATTIC ACCESS. Each living unit shall have attic access as specified in s. Comm 51.02 (18) (a). Compliance with the provisions of s. Comm 51.02 (18) (b) is not required.

(4) EXCEPTIONS. Where each living unit has a separate heating system, compliance with ss. Comm 51.08 and 57.17 is not required.

History: Cr. Register, December, 1981, No. 312, eff. 1-1-82; renum. (1) (a) and (b) to be (1) (b) and (c), cr. (1) (a), Register, August, 1985, No. 356, eff. 1-1-86; am.

(2), Register, January, 1994, No. 457, eff. 2-1-94; correction in (4) made under s. 13.93 (2m) (b) 7., Stats., Register, September, 1998, No. 513.

Comm 57.20 Accessibility requirements. All places of abode covered under this subchapter shall comply with the applicable requirements of s. Comm 52.04.

History: Cr. Register, April, 1994, No. 460, eff. 5-1-94.

Subchapter II—Accessibility Standards for Covered Multifamily Housing

Part 1—Scope, Purpose and Application

Comm 57.70 Scope. (1) COVERED. Except as specified in sub. (2), this subchapter applies to all covered multifamily housing including apartment buildings, rowhouses, townhouses and condominiums.

(2) NOT COVERED. Multilevel dwelling units with separate exterior entrances in buildings without elevators are exempt from the accessibility requirements specified in this subchapter.

History: Cr. Register, April, 1994, No. 460, eff. 5-1-94; am., Register, December, 1998, No. 516, eff. 1-1-99.

Comm 57.71 Purpose. (1) GENERAL. The purpose of this subchapter is to ensure that all buildings under the scope of this subchapter are designed and constructed to be accessible to people with disabilities.

(2) SEPARATE BUILDINGS. Dwelling units within a single structure separated by any fire-resistive rated walls within a structure do not create separate buildings, unless the walls are 4-hour fire-resistive building division walls as defined in s. Comm 51.01 (144) (a).

Note: This subchapter does not invalidate or limit the remedies, rights and procedures of federal laws or local laws that provide greater or equal protection for the rights of individuals with disabilities or individuals associated with them.

History: Cr. Register, April, 1994, No. 460, eff. 5-1-94; correction in (2) made under s. 13.93 (2m) (b) 7., Stats., Register, March, 2000, No. 531.

Part 2—Departmental Action

Comm 57.74 Plan examination and department action. Conformance with the accessibility requirements as specified in this subchapter shall be presented as a part of the general plan submittals as required under s. Comm 50.12.

History: Cr. Register, April, 1994, No. 460, eff. 5-1-94.

Part 3—Definitions

Comm 57.77 Definitions. In this subchapter:

(1) "Accessible" means able to be approached, entered and used by persons with disabilities.

(2) "Accessible route" means a continuous unobstructed path connecting accessible elements and spaces in a building or within a site or from a site to a vehicular route, that can be negotiated by all persons with a disability. Interior accessible routes include corridors, floors, ramps, elevators and lifts. Exterior accessible routes include parking access aisles, curb ramps, walks, ramps and lifts.

(3) "Bathroom" means a room which contains a water closet, lavatory and bathtub or shower.

(4) "Clear" means unobstructed.

(5) "Common use areas" means rooms, spaces or elements inside or outside of a building that are made available for the use

of residents of a building or their guests and which are not within an individual living unit.

(6) "Covered multifamily housing" means any of the following housing or dwelling units that are first ready for occupancy on or after October 1, 1993:

(a) Housing consisting of 3 or more dwelling units if the housing has one or more elevators.

(b) Grade-level dwelling units, in housing without elevators, consisting of 3 or more dwelling units.

(7) "Dwelling unit" means a single unit of residence for a household of one person or a family.

(8) "Entrance" means any exterior access door to a building or portion of a building used by residents to enter the building. An "entrance" does not include a door to a loading dock or a door used primarily as a nonrequired service entrance, even if nondisabled residents occasionally use that door to enter.

(9) "Finished grade" means the ground surface of the site after all construction, leveling, grading, and development has been completed.

(10) "Grade-level floor" means the floor of a building closest to finished grade that contains dwelling units.

Note: See s. Comm 57.81 (1) for accessible building entrances to a grade-level floor.

(11) "Loft" means an intermediate level floor between the floor and ceiling of any story located within a room or rooms of a dwelling unit.

(12) "Multilevel dwelling unit" means an individual dwelling unit with finished living space located on one floor level and a floor level immediately above or below it.

(13) "Powder room" means a room which contains a water closet and a lavatory.

(14) "Primary floor" means a floor which is intended for use by the employees or patrons, or both. A floor used primarily for mechanical purposes or storage, or both, will not be considered as a primary floor.

(15) "Public use areas" means interior or exterior rooms or spaces of a building that are made available to the general public.

(16) "Single-level dwelling unit" means an individual dwelling unit with all of the finished living space located on one floor.

(17) "Site" means a parcel of land bounded by property lines.

(18) "Slope" means the relative steepness of the land between 2 points.

(19) "Undisturbed site" means the site before any construction, leveling, grading, or development associated with the current project.

(20) "Vehicular or pedestrian arrival points" means public or resident parking areas, public transportation stops, passenger loading zones, and public streets or sidewalks.

(21) "Vehicular route" means a route intended for vehicular traffic, such as a street, driveway or parking lot.

History: Cr. Register, April, 1994, No. 460, eff. 5-1-94; r. (c), Register, December, 1998, No. 516, eff. 1-1-99.

Part 4—General Requirements

Comm 57.78 Accessibility requirements, new construction. All covered multifamily housing constructed on or after May 1, 1994 shall comply with the accessibility requirements in ss. Comm 57.81 to 57.871.

History: Cr. Register, April, 1994, No. 460, eff. 5-1-94.

Comm 57.79 Accessibility requirements for additions and remodeled covered multifamily housing.

(1) GENERAL. All existing multifamily housing being remodeled or added to under this section shall comply with the following:

(a) *More than 50% remodeled or added.* If more than 50% of the gross interior area of an existing multifamily housing building is remodeled or added to, the entire building shall be designed and constructed in accordance with the accessibility requirements specified in ss. Comm 57.81 to 57.871.

(b) *25% to 50% remodeled or added.* If 25% to 50% of the gross interior area of an existing multifamily housing building is remodeled or added to, that portion of the building being remodeled or added to shall be designed and constructed in accordance with the accessibility standards specified in ss. Comm 57.81 to 57.871.

(c) *Less than 25% remodeled or added.* If less than 25% of the gross interior area of an existing multifamily housing building is remodeled or added to, the remodeling is not subject to the accessibility standards specified in ss. Comm 57.81 to 57.871, unless the alteration involves work on interior doors, entrances, exits, bathrooms or toilet rooms, in which case the interior doors, entrances, exits, bathroom or toilet rooms shall comply with the standards specified in ss. Comm 57.81 to 57.871.

(2) REMODELING OR ADDING IN STAGES. The percentage requirements established in this section apply to the accumulative sum of any remodeling or additions, or both, undertaken after May 1, 1994.

(3) EXISTING BUILDINGS WITH MIXED OCCUPANCIES. (a) *Buildings with an area of 20,000 square feet or less.* If an existing building with mixed occupancies is remodeled or added to and the gross interior area of the building after remodeling or adding to is 20,000 square feet or less, access and interior circulation shall be provided to a primary floor. Interior circulation between floor levels is not required.

(b) *Buildings with an area greater than 20,000 square feet.* If an existing building with mixed occupancies is remodeled or added to and the gross interior area of the building after the remodeling or adding to is greater than 20,000 square feet, access and interior circulation shall be provided to all floor levels. The method of interior circulation provided between the floor levels shall comply with the applicable provisions in s. Comm 52.04.

(4) CHANGE OF USE. If the use of an existing building is changed to a covered multifamily housing use and building is remodeled or added to, the building shall comply with this section.

History: Cr. Register, April, 1994, No. 460, eff. 5-1-94.

Part 5—Accessibility Requirements

Comm 57.81 Accessible building entrance on an accessible route. Covered multifamily housing shall comply with this section and Table 57.81 for the number of accessible entrances and exits, dwelling units and the accessible interior features required in the dwelling units.

(1) ACCESSIBLE BUILDING ENTRANCES TO A GRADE-LEVEL FLOOR. Except for covered multifamily housing with site impracticality as specified in sub. (4), the grade-level floor of each covered multifamily housing building on a site shall be served by a building entrance on an accessible route. In addition to the designated grade-level floor with dwelling units, all other floors containing dwelling units which are located within 30 inches of finished grade shall be served by a building entrance on an accessible route.

(2) ACCESSIBLE ENTRANCE DOOR. Each accessible entrance door to a covered multifamily housing building shall be at least 36 inches in width. Minimum space requirements at the latch side of the door shall comply with the applicable portions of Table 57.82.

(3) ACCESSIBLE ROUTE. Except for covered multifamily housing with site impracticality as specified in sub. (4), each building on a site shall have at least one accessible route complying with applicable portions of Table 57.82.

Table 57.81
NEW CONSTRUCTION REQUIREMENTS

Types of Covered Multifamily Housing	Number of Accessible Entrances ¹	Number of Required Accessible Exits from Grade-Level Floor	Number of Accessible Dwelling Units	Accessible Features of Dwelling Unit
I. Covered multifamily housing without elevators				
A. Housing with common entrances to a grade-level floor with dwelling units				
1. Single-level dwelling units	All entrances ³	All required exits ^{4,5,6}	All dwelling units on the grade-level floor	ss. Comm 57.82 to 57.871
2. Multilevel dwelling units	All entrances ³	All required exits ^{4,5,6}	Grade-level portion of dwelling units on the grade-level floor	ss. Comm 57.82 to 57.871
B. Housing with separate exterior entrances to each dwelling unit				
1. Single-level dwelling units	All entrances ³	All required exits ^{4,5,6}	All grade-level dwelling units	ss. Comm 57.82 to 57.871
II. Covered multifamily housing with elevators				
A. Single-level dwelling units	All entrances ³	All required exits ^{4,5,6}	All dwelling units on all floors served by an elevator shall be accessible	ss. Comm 57.82 to 57.871 required in all dwelling units on all floors served by an elevator
B. Multilevel dwelling units	All entrances ³	All required exits ^{4,5,6}	Grade-level portions of all multilevel dwelling units on all floors served by an elevator shall be accessible	ss. Comm 57.82 to 57.871 required in grade-level portion of all dwelling units on all floors served by an elevator

¹An accessible entrance may also serve as a required exit.

²Exits required by chs. Comm 50 to 64.

³Where all entrances are not accessible, site impracticality for the nonaccessible entrances shall be determined through the petition process.

⁴Where a rescue platform as specified in s. Comm 57.05 (2) or an exterior stairway is provided as a second exit from an individual dwelling unit, the rescue platform or exterior stairway shall be sized to accommodate at least one wheelchair space. The wheelchair space shall measure at least 30 inches by 48 inches and the swing of the exit door shall not infringe into the wheelchair space.

⁵A second exit from a grade-level floor with dwelling units may be to an exterior stairway, providing the exit stairway platform is sized to accommodate space for 2 wheelchairs. Each wheelchair space shall measure at least 30 inches by 48 inches and the swing of the exit door shall not infringe into the wheelchair spaces.

⁶Where all exits are not accessible, site impracticality for the nonaccessible exits shall be determined through the petition process.

⁸Where a building elevator is provided only as a means of creating an accessible route to dwelling units on a grade-level floor, the building is not considered an elevator building, only the grade-level dwelling units shall be accessible.

(4) **SITE IMPRACTICALITY DUE TO TERRAIN OR UNUSUAL CHARACTERISTICS OF THE SITE.** (a) *Petition for variance.* Except for housing in floodplains or coastal high-hazard areas as specified in par. (d), the department may grant a variance from the requirements relating to an accessible entrance or an accessible route to a covered multifamily housing without elevators, if the person designing, constructing or remodeling the housing shows that complying with the accessible entrance or an accessible route is impractical because of the terrain or unusual characteristics of the site. Site impracticality shall be determined through the petition for variance procedure specified in s. Comm 50.25.

(b) *Determining site impracticality.* To determine the site impracticality of an undisturbed site, the designer shall use the site impracticality requirements as specified in requirement number 1., (2) of the federal fair housing accessibility guidelines, as printed in the federal register, volume 56, number 44, on March 6, 1991.

Note: See Appendix for a copy of the site impracticality guidelines from the federal register.

(c) *Petition conditions and waiver.* Exterior accessibility shall be provided to at least 50% of the dwelling units of covered multifamily housing at one site. The department may impose specific conditions in granting a variance to promote exterior accessibility of the covered multifamily housing to persons with disabilities. If the department finds that exterior accessibility is impractical to all dwelling units at a site, the department may grant a waiver from the exterior requirements under sub. (1).

(d) *Floodplains and coastal high-hazard areas.* A petition for variance is not required for covered multifamily housing located in a federally, state or locally designated floodplain or coastal high-hazard area. Written documentation shall be submitted to this department for approval indicating the covered multifamily housing building is located such that the lowest floor or the lowest structural member of the lowest floor must be raised to a specified level at or above the base flood elevation.

History: Cr. Register, April, 1994, No. 460, eff. 5-1-94; emerg. r. table I. B. line 2., eff. 6-14-98; r. footnote 7 of table I, Register, December, 1998, No. 516, eff. 1-1-99.

Comm 57.82 Accessible and usable public and common use areas. (1) **GENERAL PUBLIC AND COMMON USE AREAS.** All public and common use areas, such as hallways, lounges, lobbies, laundry rooms, refuse rooms, mail rooms, recreational areas and passageways among and between buildings in covered multifamily housing shall comply with Table 57.82 and the appropriate sections of the Americans with Disabilities Act Accessibility Guidelines (ADAAG), as printed in Part III of the July 26, 1991 Federal Register and the September 6, 1991 Federal Register and as corrected in the January 14, 1992 Federal Register. Table 57.82 cites the appropriate section of the ADAAG standards and describes the appropriate application of the standards, including modifications to the referenced standard.

Note: Copies of the ADAAG standards can be obtained from the New Orders, Superintendent of Documents, P.O. Box 371954, Pittsburgh, Pennsylvania 15250-7954.

(2) **ACCESSIBLE PARKING SPACES.** If parking spaces, such as surface parking or garage parking, are provided at covered multi-

family housing, accessible parking spaces shall be provided and designed in accordance with the following:

(a) *Size.* 1. Tenant parking. a. Except as specified in subpar. b, an accessible parking space shall be at least 96 inches wide with an adjacent marked access aisle at least 60 inches wide.

b. A private garage serving an individual accessible dwelling unit shall have a minimum clear inside dimension of 13 feet in width.

2. Visitor parking. An accessible parking space when provided for visitors shall be at least 96 inches wide with an adjacent marked access aisle at least 60 inches wide.

(b) *Number of accessible parking spaces.* 1. Tenant parking. At least 2% of the total number of tenant parking spaces at each type of parking facility, such as surface parking or garage parking, shall be accessible. In no case shall there be less than one accessible parking space at each type of parking facility at each building.

2. Visitor parking. If visitor parking is provided in addition to the tenant parking, at least 2% of the visitor parking spaces, with a minimum of one, shall be accessible.

(c) *Accessible route.* 1. General. Except as specified in subd. 2., an exterior accessible route shall be provided from each accessible parking space to an accessible building entrance. The accessible parking spaces shall be located as close as possible to the accessible building entrance.

2. Exceptions. a. In a covered multifamily housing building with underground parking, interior circulation to a grade-level floor with dwelling units may be provided in lieu of an exterior accessible route from the underground parking to an accessible building entrance. The method of interior circulation shall be an elevator or another approved method of interior circulation as specified in s. Comm 52.04 and ch. Comm 18.

b. In a covered multifamily housing building without elevators and having underground parking, on-grade covered garage parking located on an exterior accessible route to an accessible building entrance may be used in lieu of the underground accessible parking spaces and the exterior accessible route from the underground parking facility.

3. Private attached garages. If a single-level dwelling unit or an accessible multilevel dwelling unit has an attached garage which serves only that dwelling unit, an exterior or interior accessible route shall be provided from the attached garage to an accessible dwelling unit entrance.

(d) *Passenger loading zones.* If passenger loading zones are provided, the passenger loading zones shall be designed and installed to comply with ADAAG 4.6.6.

(e) *Identification.* 1. Tenant parking. The accessible tenant parking spaces provided at covered multifamily housing shall be designated with a sign which clearly states that the parking space is reserved for use by tenants with disabilities. The sign specified in s. Trans 200.07 shall not be used to identify tenant accessible parking spaces.

2. Visitor parking. Accessible visitor parking spaces shall be identified with a sign complying with s. Trans 200.07. Additional signs shall be installed to direct persons from the accessible parking space to the accessible entrance.

TABLE 57.82
BASIC COMPONENTS FOR ACCESSIBLE AND USABLE PUBLIC AND COMMON USE AREAS OR FACILITIES

Accessible element or space	ADAAG Section	Application
1. Accessible route(s)	4.3	(1) Except as specified in (2), within the boundary of the site: (a) From public transportation stops, accessible parking spaces, accessible passenger loading zones, and public streets or sidewalks to accessible building entrances. (b) Connecting accessible buildings, facilities, elements and spaces that are on the same site. Handrails are not required on accessible walks. Handrails shall be provided on ramps with a slope of 1:12. (c) Connecting accessible building or facility entrances with accessible spaces and elements within the building or facility, including adaptable dwelling units. (2) Where site or legal constraints prevent a route accessible to persons using wheelchairs between covered multifamily dwellings and public or common use facilities elsewhere on the site, a vehicular route may be provided as an alternative accessible route, providing there is accessible parking at each facility. Other site provisions shall comply with the applicable portions of this table.
2. Protruding objects	4.4	Accessible route or maneuvering space including, but not limited to halls, corridors, passageways or aisles.
3. Ground and floor surface treatments	4.5	Accessible routes, rooms and spaces, including floors, walks, ramps, stairs and curb ramps.
4. Parking and passenger loading zones	4.6.6	If provided, accessible parking at covered multifamily housing shall comply with s. Comm 57.82 (2). If provided, passenger loading zones shall comply with ADAAG 4.6.6.
5. Curb ramps	4.7	Accessible routes crossing curbs.
6. Ramps	4.8	Accessible routes with slopes greater than 1:20 shall comply with ADAAG 4.8, except the ramp width shall be at least 48 inches.
7. Stair	4.9	Stairs on accessible routes connecting levels not connected by an elevator. Stairs not on accessible routes shall comply with s. Comm 57.07.
8. Elevator	4.10	If provided, elevators shall comply with s. Comm 52.04 and ch. Comm 18.
9. Platform lift	4.11	May be used in lieu of an elevator or ramp only as specified in s. Comm 52.04.
10. Drinking fountains and water coolers	4.15	Fifty percent of fountains and coolers on each floor, or at least one, water coolers if provided in the facility or at the site.
11. Toilet rooms and bathing facilities (including water closets, toilet-rooms and stalls, urinals, lavatories and mirrors, bathtubs, shower stalls and sinks)	4.22	Where provided in public use and common use facilities, at least one of each fixture provided per room.
12. Seating, tables or work surfaces	4.32	If provided inaccessible spaces, at least one of each type provided.
13. Places of assembly	4.33	If provided in the facility or at the site.
14. Common use spaces and facilities (including swimming pools, playgrounds, entrances, rental offices, lobbies, elevators, mailbox areas, lounges, halls and corridors, and the like)	4.1 through 4.33	If provided in the facility or at the site: (a) Where multiple recreational facilities such as, but not limited to tennis or racketball courts, are provided at least 10% with a minimum of one recreational facilities or game area of each type shall be accessible. (b) Access is required to all spectator viewing for recreational facilities. (c) Access is required only to the deck area of such facilities as, but not limited to, swimming pools and whirlpools. (d) Where practical, access to all or a portion of nature trails and jogging paths.
15. Laundry rooms	4.32.6	If provided in the facility or at the site, at least one of each type of appliance provided in each accessible laundry area shall be accessible. Where washers are provided, at least one washer shall be front-loading.

History: Cr. Register, April, 1994, No. 460, eff. 5-1-94; correction in (2) (c) 2. made under s. 13.93 (2m) (b) 7., Stats., Register, December, 1996, No. 492.

Comm 57.83 Usable doors. All covered multifamily housing shall provide usable doors as follows:

(1) **PUBLIC AND COMMON USE AREAS.** (a) *Doorways.* All doorways that are part of an accessible route in the public and common use areas of covered multifamily housing shall have a minimum clear opening of 32 inches in width and shall comply with the applicable portions of Table 57.82, and Figures 57.83-1 and 57.83-2.

(b) *Double leaf doorways.* Where double leaf doorways are used in covered multifamily housing at least one door leaf shall provide a minimum clear opening of 32 inches in width.

(c) *Lever door handles.* Lever door handles shall be provided on all entrance and exit doors and on all entrance doors to individual dwelling units of covered multifamily housing.

(2) **INDIVIDUAL DWELLING UNITS.** (a) *Doorways.* All single leaf doorways and at least one door leaf of double leaf doorways into and within individual dwelling units shall provide a minimum clear opening of at least 32 inches nominal width between the face of the door and stop.

Note: A 34-inch door, hung in the standard manner, provides an acceptable nominal 32-inch clear opening. This door can be adapted to provide a wider opening by using offset hinges, by removing lower portions of the door stop or both. Pocket or sliding doors are acceptable doors in covered multifamily dwelling units and have the added advantage of not impinging on clear floor space in small rooms. The nominal 32-inch clear opening provided by a standard six-foot sliding patio door assembly is acceptable.

(b) *Doorways and corridors.* All doorways and corridors shall be designed to provide access and shall comply with the minimum design standards specified in Figure 57.83-2.

(c) *Lever door handles.* Lever door handles on interior dwelling unit doors may be requested by the renter and shall be provided by the landlord at no additional cost to the renter.

FIGURE 57.83-1 CLEAR DOORWAY WIDTH AND DEPTH

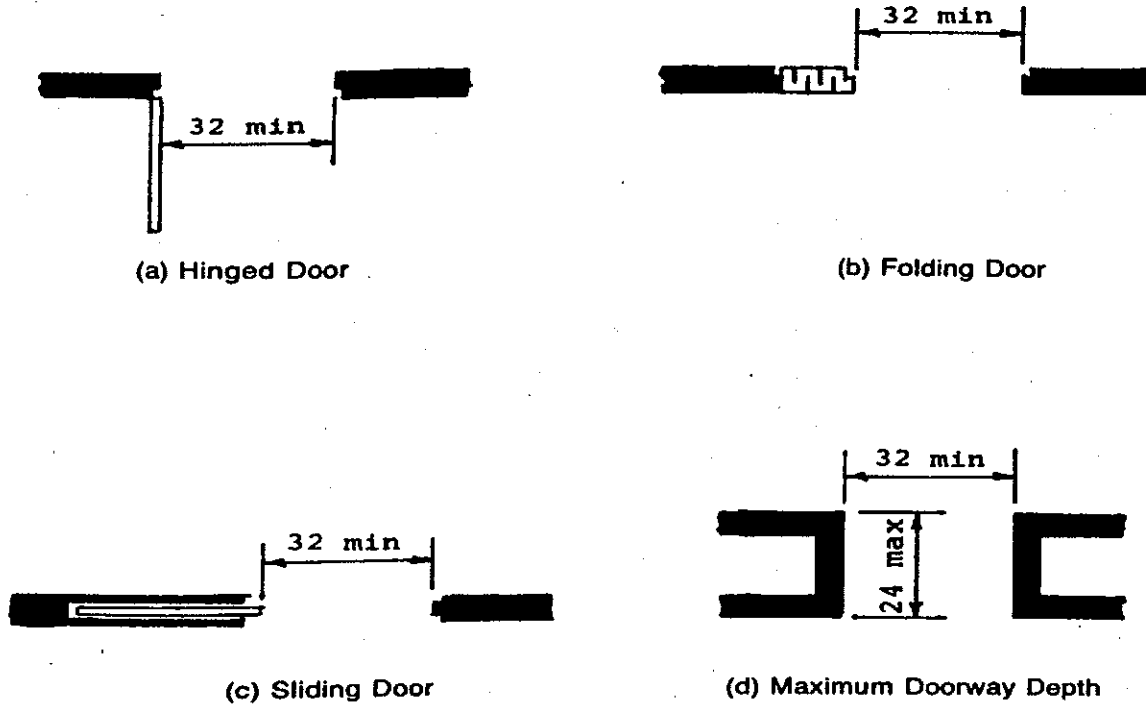
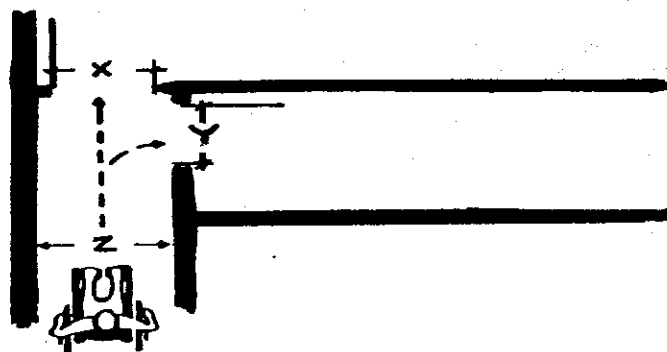


FIGURE 57.83-2 DOORWAYS AND CORRIDORS



MINIMUM CLEAR DOORWAY AND CORRIDOR DIMENSIONS		
CORRIDOR WIDTH Z Dimension ¹	DOORWAY CLEARANCES	
	X(Straight run)	Y(90 degree turn)
36 inches	32 inches	36 inches
38 inches	32 inches	36 inches
40 inches	32 inches	34 inches
42 inches and greater	32 inches	32 inches

¹The corridor width, Z dimension, shall be maintained for a distance of at least 5 feet from the edge of the door opening.

History: Cr. Register, April, 1994, No. 460, eff. 5-1-94.

Comm 57.84 Accessible route into and through the covered dwelling unit. (1) **ACCESSIBLE ROUTE.** Except as specified in sub. (2), an accessible route complying with the following requirements shall be provided throughout a dwelling unit in covered multifamily housing.

(a) *Minimum width.* An accessible route shall provide a minimum clear width of 36 inches.

(b) *Changes in floor level.* Within dwelling units, changes in floor levels between $\frac{1}{4}$ inch and $\frac{1}{2}$ inch shall be beveled with a slope no greater than 1:2. Changes in level greater than $\frac{1}{2}$ inch shall be ramped in accordance with the applicable portions of Table 57.82.

(c) *Thresholds at exterior doors.* Thresholds at exterior doors, including sliding door tracks, shall be no higher than $\frac{3}{4}$ inch. Thresholds and changes in level at exterior door locations shall be beveled with a slope no greater than 1:2.

(d) *Exterior landing.* 1. Except as specified in subd. 2., an exterior landing shall be provided at all required exits or entrances of covered multifamily housing and the landing shall be no more than $\frac{1}{2}$ inch below the floor level of the interior of the dwelling unit. The exterior landing shall have a side slope not greater than $\frac{1}{8}$ inch per foot and shall be at least 5 feet deep measured perpendicular to the door and shall provide at least 18 inches of clear landing surface adjacent to the door knob side of the door.

2. Exterior deck, patio or balcony surfaces shall be no more than $\frac{1}{2}$ inch below the floor level of the interior of the dwelling unit, unless the exterior deck, patio or balcony surfaces are constructed of impervious material such as, but not limited to, concrete, brick or flagstone. In such cases, the surface shall be no more than 4 inches below the floor level of the interior of the dwelling unit.

(2) **EXCEPTIONS.** (a) *Raised or sunken areas.* An accessible route is not required to a raised or sunken area of an individual dwelling unit. The raised or sunken area shall not interrupt the accessible route throughout the remainder of the dwelling unit.

(b) *Single-level dwelling units with lofts.* Single-level dwelling units may include lofts. In single-level dwelling units with lofts, all spaces other than the loft shall be on an accessible route. All portions of a loft shall be open and unobstructed to the room in which they are located, except for columns and posts and protective walls or railings not more than 44 inches in height. The area of the loft shall not be more than one-third of the area of the floor level located directly below the loft in the dwelling unit.

(c) *Multilevel dwelling units in housing with elevators.* In multilevel dwelling units in buildings with elevators, an accessible route shall be provided on the level of the dwelling unit which is served by the building elevator and shall:

1. Include the primary entry to the dwelling unit;

2. Comply with the accessibility standards specified under this subchapter with respect to the rooms located on the entry or accessible floor; and

3. Contain a bathroom or a powder room which complies with ss. Comm 57.86 and 57.871.

History: Cr. Register, April, 1994, No. 460, eff. 5-1-94; emerg. r. (2) (d), eff. 6-14-98; r. (2) (d), Register, December, 1998, No. 516, eff. 1-1-99.

Comm 57.85 Light switches, electrical outlets, thermostats and other environmental controls in accessible locations. Light switches, electrical outlets, thermostats, circuit controls and other environmental controls installed in covered multifamily housing shall be located for use by the tenant as follows:

(1) **HEIGHT OF CONTROLS.** Except as specified in sub. (2), operable parts of the controls shall be located no higher than 48 inches and no lower than 15 inches above the floor.

(2) **HEIGHT OF CONTROLS OVER OBSTRUCTIONS.** If a person is required to reach over an obstruction which is between 20 and 25 inches in depth, the maximum height shall be reduced to 44 inches for a forward approach or 46 inches for a side approach. Obstructions shall not extend more than 25 inches from the wall beneath a control.

Note: See Appendix for example of reach dimensions over an obstruction.

History: Cr. Register, April, 1994, No. 460, eff. 5-1-94.

Comm 57.86 Reinforced walls for grab bars. All covered multifamily housing shall provide reinforced walls for grab bars as follows:

(1) **LOCATION.** (a) Except as specified in sub. (2), reinforced bathroom walls shall be provided to allow the later installation of grab bars around the water closet, tub, shower stall and shower seat, where such facilities are provided. Reinforced areas shall be provided at least at those points where grab bars will be mounted as shown in Figures 57.86-1, 57.86-2 and 57.86-3.

(b) If a powder room, containing a water closet and sink, is the only toilet facility located on an accessible level of a multilevel dwelling unit, reinforced bathroom walls shall be provided to allow the later installation of grab bars around the water closet and sink.

(2) **EXCEPTION.** Where the water closet is not placed adjacent to a side wall, the areas where the installation of floor mounted, foldaway or similar alternative grab bars would be installed shall be reinforced.

Note: A sunken tub placed away from walls could have reinforced areas for installation of floor-mounted grab bars. The same principle applies to shower stalls; for example glass-walled stalls could be planned to allow floor-mounted grab bars to be installed later.

Note: Reinforcement for grab bars may be provided in a variety of ways such as, by plywood or wood blocking, so long as the necessary reinforcement is placed so as to permit later installation of appropriate grab bars.

FIGURE 57.86-1
LOCATION OF GRAB BAR REINFORCEMENT FOR WATER CLOSETS

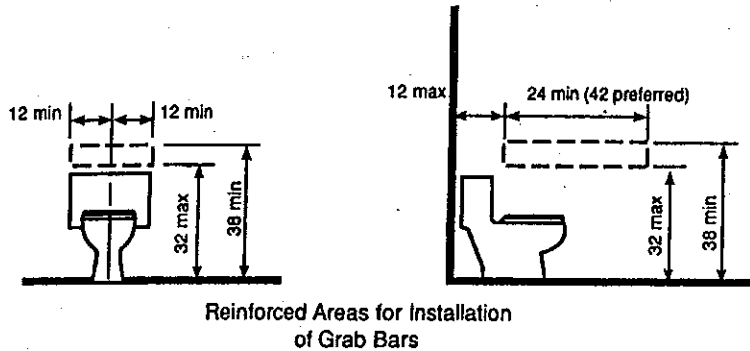
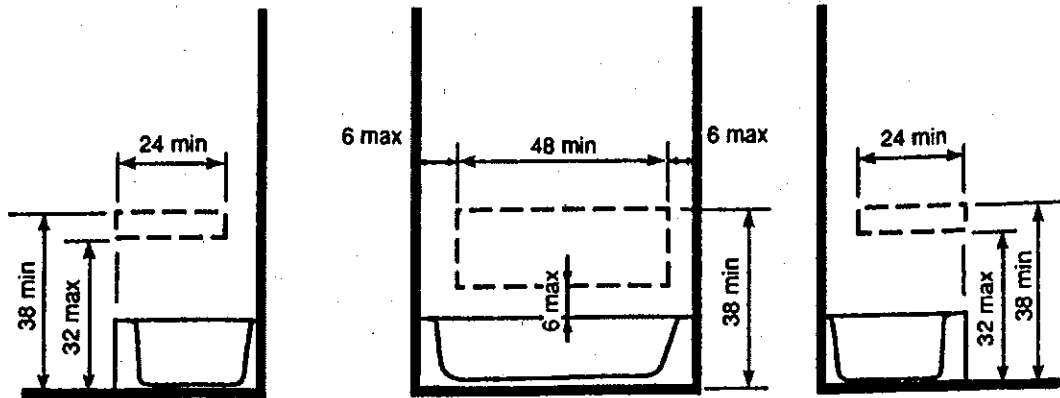
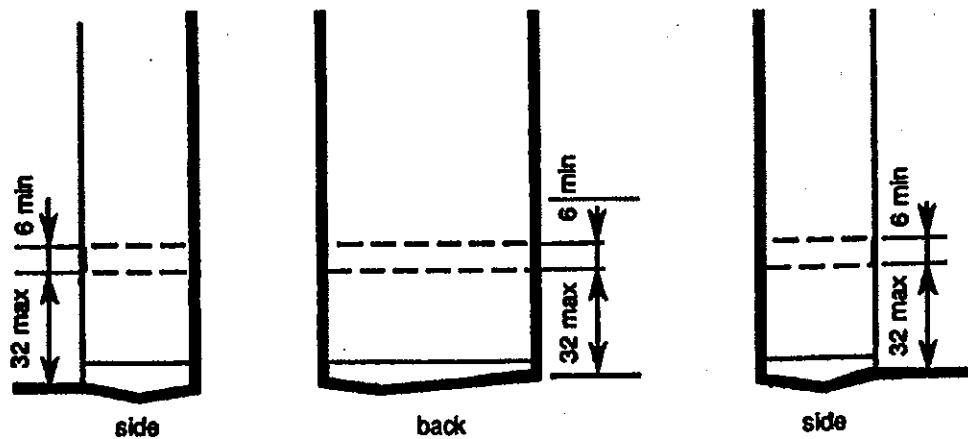


FIGURE 57.86-2
LOCATION OF GRAB BAR REINFORCEMENT FOR ADAPTABLE BATHTUBS



NOTE: The areas outlined in dashed lines represent locations for future installation of grab bars for typical fixture configurations.

FIGURE 57.86-3
LOCATION OF GRAB BAR REINFORCEMENTS FOR ADAPTABLE SHOWERS



NOTE: The areas outlined in dashed lines represent locations for future installation of grab bars.

Comm 57.87 Usable kitchens. Kitchens of covered multifamily housing shall be designed and constructed as follows:

(1) **CLEAR FLOOR SPACE.** A clear floor space at least 30 inches by 48 inches that allows a parallel approach by a person in a wheelchair shall be provided at the range or cooktop and sink, and either a parallel or forward approach shall be provided at the oven, dishwasher, refrigerator, freezer or trash compactor.

Note: See Appendix for the minimum clear floor space for wheelchairs.

(2) **CLEARANCE BETWEEN COUNTERS.** Clearance between counters and all opposing base cabinets, countertops, appliances or walls shall be at least 40 inches.

(3) **U-SHAPED KITCHENS.** In U-shaped kitchens with a sink, range or cooktop at the base of the "U," a 60-inch turning radius shall be provided to allow a parallel approach, or the base cabinets shall be removable at that location to allow knee space for a forward approach.

History: Cr. Register, April, 1994, No. 460, eff. 5-1-94.

Comm 57.871 Usable bathrooms. At least one bathroom in a dwelling unit shall be designed in accordance with sub. (2). All other bathrooms shall comply with sub. (1).

(1) **BASIC USABILITY.** (a) *Design of bathroom.* Maneuvering space shall be provided within the bathroom for a person using a wheelchair or other mobility aid to enter and close the door, use the fixtures, reopen the door and exit. Doors may swing into the clear floor space provided at any fixture if the maneuvering space is provided. Maneuvering spaces may include any kneespace or toespace available below bathroom fixtures.

Note: See Appendix for an example of a bathroom complying with the basic usability requirements.

(b) *Clear floor space.* Clear floor space of 30 inches by 48 inches shall be provided at all fixtures. Clear floor space at fixtures may overlap.

Note: See Appendix for examples of clear floor space at bathroom fixtures.

Note: Cabinets under lavatories are acceptable provided the bathroom has space to allow a parallel approach by a person in a wheelchair. If a parallel approach is not possible within the space, any cabinets provided would have to be removable to afford the necessary knee clearance for a forward approach.

(c) *Shower stall.* If a shower stall is the only bathing facility provided in the covered dwelling unit, the shower stall shall have an inside dimension at least 36 inches by 36 inches.

(2) **HIGHER LEVEL OF USABILITY.** (a) *Design of bathroom.* 1. Where the door swings into the bathroom, a clear floor space of 30 inches by 48 inches shall be provided within the room for a person to position a wheelchair or other mobility aid clear of the

swing of the door and to permit use of fixtures. This clear floor space may include any kneespace and toespace available below bathroom fixtures.

2. Where the door swings out of the bathroom, a clear floor space of 30 inches by 48 inches shall be provided within the bathroom for a person using a wheelchair or other mobility aid to position the wheelchair such that the person is allowed use of fixtures. Clear floor space shall be provided to allow persons using wheelchairs to reopen the door to exit.

Note: See Appendix for examples of bathrooms complying with the higher level of usability.

(b) *Water closets.* Water closets shall be located within bathrooms so that a grab bar may be installed on one side of the water closet. In locations where water closets are adjacent to walls or bathtubs, the centerline of the water closet shall be a minimum of 18 inches from the obstacle. The side of the water closet without a grab bar shall be a minimum of 15 inches measured from the centerline of the water closet to the finished surface of adjacent walls, vanities or the edge of a lavatory.

Note: See Appendix for examples of clear floor space at water closets.

(c) *Vanities and lavatories.* When 2 or more lavatories are provided in a bathroom, at least one lavatory shall be made accessible.

1. Vanities and lavatories shall be installed with the centerline of the lavatory a minimum of 15 inches, measured horizontally, from an adjoining wall or fixture.

2. The top of the fixture rim shall be a maximum height of 34 inches above the finished floor.

3. A clear floor space at least 30 inches by 48 inches shall be provided at a lavatory for either a parallel or front approach. If a front approach is used, full kneespace shall be provided below the lavatory at least 17 inches in depth. If kneespace is provided below the vanity, the bottom of the apron shall be at least 27 inches above the floor.

Note: See Appendix for examples of clear floor space at lavatories.

(d) *Bathtub and shower fixtures.* When both bathtub and shower fixtures are provided in the bathroom, at least one fixture shall be made accessible.

1. Bathtubs. a. Where the centerline of the controls is located not more than 9 inches from the apron of the bathtub, a clear floor space at least 30 inches by 48 inches shall extend at least 5 inches beyond the head of the bathtub as shown in Figure 57.871-1

FIGURE 57.871-1
CLEAR FLOOR SPACE/OFFSET CONTROLS

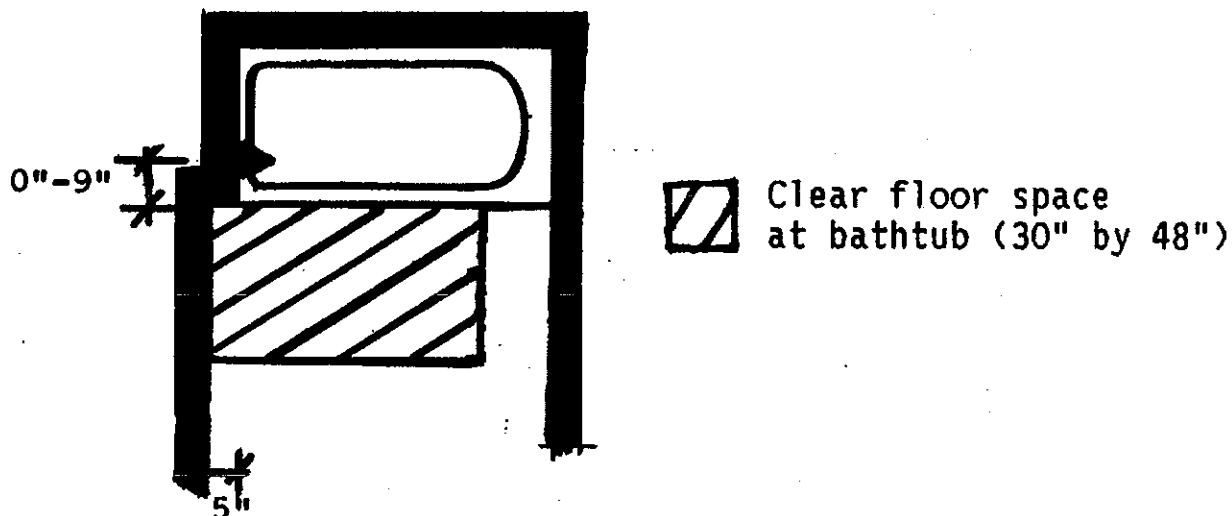
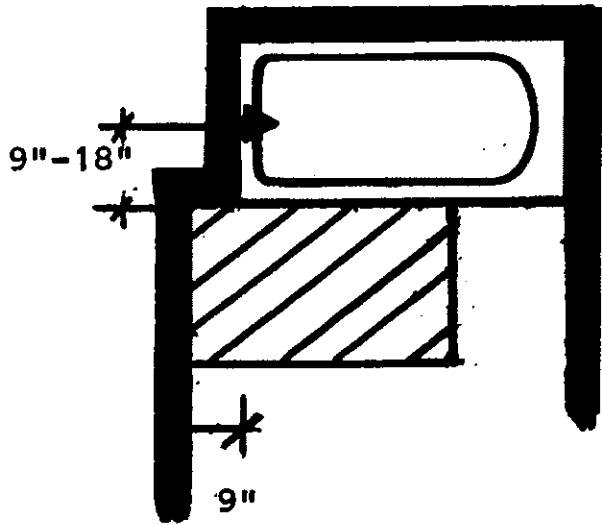


FIGURE 57.871-2
CLEAR FLOOR SPACE/CENTERED CONTROLS



 Clear floor space
at bathtub (30" by 48")

b. Where the centerline of the controls is located between 9 inches and 18 inches from the apron of the bathtub, a clear floor space at least 30 inches by 48 inches shall extend at least 9 inches beyond the head of the bathtub as shown in Figure 57.871-2.

2. Shower stalls. a. Shower stalls in a bathroom shall have an inside dimension [at] least 36 inches by 36 inches.

b. A minimum clear floor space 30 inches wide by 48 inches shall be provided outside the stall.

Note: See Appendix for an example of clear floor space.

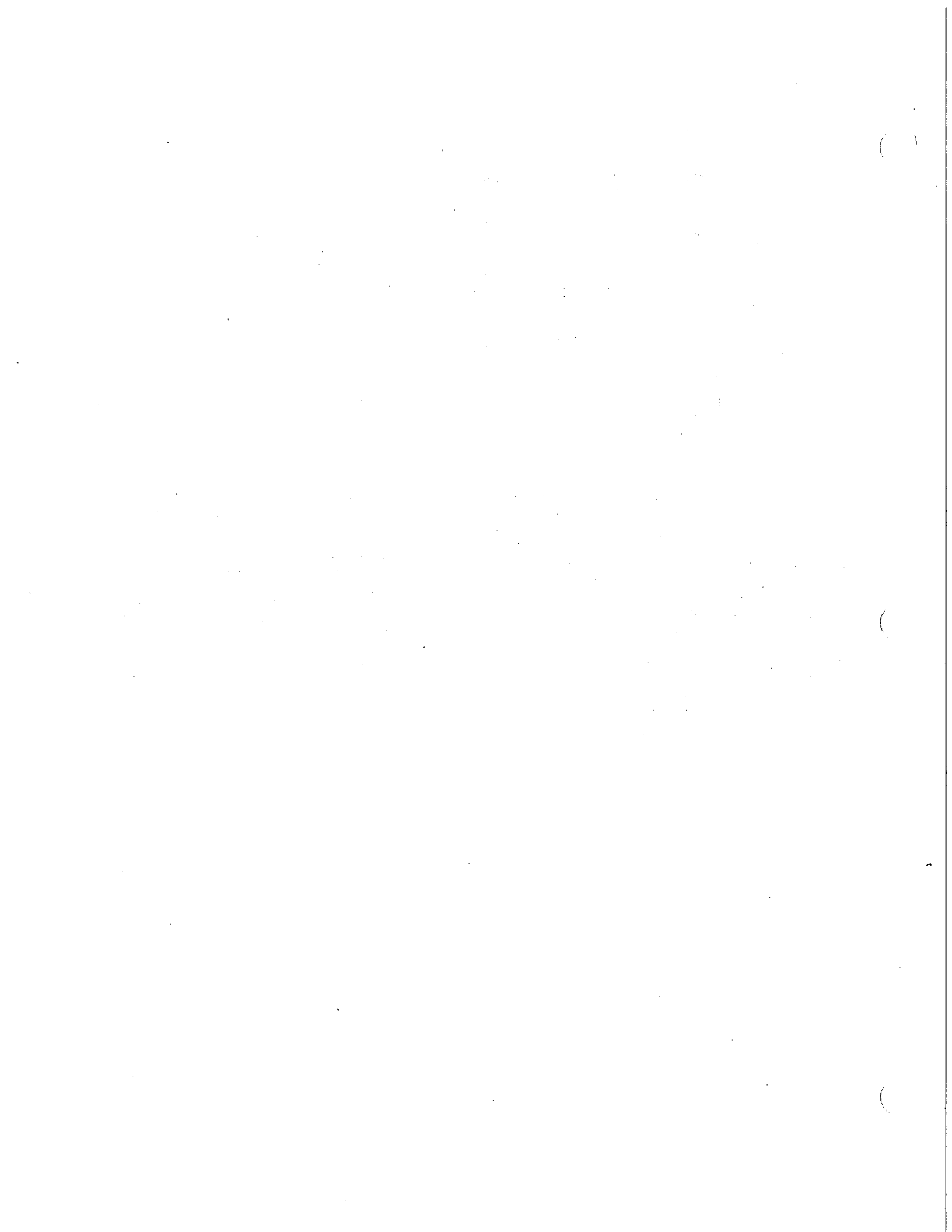
c. If the shower stall is the only bathing facility provided in the covered dwelling unit, or on the accessible level of a covered multilevel unit, the shower stall shall have reinforcing to allow for installation of a wall hung bench seat.

(3) POWDER ROOMS. Where a powder room is the only toilet room provided on the grade-level floor of a multilevel dwelling unit, the powder room shall be designed and constructed in accordance with the applicable portions of sub. (2).

Note: See Appendix for examples of adaptable powder rooms.

(4) SINGLE-LEVER PLUMBING CONTROLS. Single-lever plumbing controls or other controls which are approved by the department, may be requested by the renter for installation on plumbing fixtures used by the renter and shall be provided by the landlord at no additional cost to the renter.

History: Cr. Register, April, 1994, No. 460, eff. 5-1-94; corrections in (2) (d) 1. made under s. 13.93 (2m) (b) 12., Stats., Register, October, 1994, No. 466.



Chapter Comm 58

HEALTH CARE, DETENTION AND CORRECTIONAL FACILITIES

Subchapter I — Health Care Facilities

Comm 58.001	Scope.
Comm 58.01	Class of construction.
Comm 58.02	Occupancy separations and hazard enclosures.
Comm 58.03	Windows.
Comm 58.04	Required means of egress.
Comm 58.05	Number and type of exits.
Comm 58.06	Stairs.
Comm 58.07	Handrails.
Comm 58.08	Guardrails.
Comm 58.09	Smokeproof towers.
Comm 58.10	Horizontal exits.
Comm 58.11	Ramps.
Comm 58.12	Capacity of means of egress.
Comm 58.13	Arrangement of means of egress.
Comm 58.14	Measurement of travel distance to exits.
Comm 58.15	Discharge from exits.
Comm 58.16	Illumination of means of egress.
Comm 58.17	Emergency lighting.
Comm 58.18	Marking of means of egress.
Comm 58.19	Headroom.
Comm 58.20	Key locking hardware.
Comm 58.21	Protection of openings.
Comm 58.23	Protection of vertical openings.
Comm 58.24	Protection from hazards.
Comm 58.25	Rubbish chutes and laundry chutes.
Comm 58.26	Interior finish.
Comm 58.27	Detection, alarm and communication systems.
Comm 58.28	Standpipes.
Comm 58.29	Automatic sprinkler and other suppression systems.
Comm 58.30	Smoke barrier.
Comm 58.31	Construction of corridor walls.

Comm 58.32 Sanitary facilities.

Subchapter II — Detention and Correctional Facilities

Comm 58.40	Scope.
Comm 58.41	Definitions.
Comm 58.42	Class of construction.
Comm 58.43	Program support facilities.
Comm 58.44	Separation from other occupancies and hazard enclosures.
Comm 58.45	Windows.
Comm 58.46	Size of sleeping rooms.
Comm 58.47	Sleeping rooms below grade.
Comm 58.48	Required means of egress.
Comm 58.49	Exit doors, number and type of exits.
Comm 58.50	Stairways.
Comm 58.51	Smokeproof towers.
Comm 58.52	Horizontal exits.
Comm 58.53	Ramps.
Comm 58.54	Required exit width.
Comm 58.55	Arrangement of means of egress.
Comm 58.56	Measurement of travel distance to exits.
Comm 58.57	Illumination of means of egress.
Comm 58.575	Emergency lighting.
Comm 58.58	Marking of means of egress.
Comm 58.59	Door locks.
Comm 58.60	Protection of openings.
Comm 58.61	Protection of vertical openings.
Comm 58.63	Fire protection systems.
Comm 58.64	Fire alarms.
Comm 58.65	Automatic smoke detection system.
Comm 58.66	Interior finishes.
Comm 58.67	Smoke barrier.
Comm 58.68	Sanitary facilities.
Comm 58.69	Guard towers and observation stations.

Note: Chapter Ind 58 was renumbered chapter ILHR 58 effective January 1, 1984. Corrections made under s. 13.93 (2m) (b) 7., Stats., Register, March, 1997, No. 495. Chapter ILHR 58 was renumbered to be chapter Comm 58 under s. 13.93 (2m) (b) 1., Stats., and corrections made under s. 13.93 (2m) (b) 7., Stats., Register, September, 1998, No. 513.

Subchapter I — Health Care Facilities

Part 1 — Scope

Comm 58.001 Scope. (1) GENERAL. The provisions of this subchapter shall apply, on or after the effective date of this section, to the following:

(a) New health care facilities and additions to existing health care facilities;

(b) Alterations and remodeling affecting structural strength, fire hazard, natural lighting or replacement of major equipment. Alterations and remodeling do not include minor repairs necessary for the maintenance of any building or structure. Where buildings are being remodeled or altered, only those components or systems being remodeled or altered shall be made to conform with the rules in effect at the time the remodeling or alteration occurs; and

(c) Change of use where the requirements for the new use are more stringent than those for the previous use.

(2) APPLICATION. (a) The rules of this subchapter are not retroactive unless specifically stated in the individual administrative rule.

(b) The rules of this subchapter do not apply to alterations or remodeling of buildings, constructed prior to the effective date of this paragraph, being undertaken solely for the purpose of obtaining federal certification or state licensure.

(c) Where other sections of chs. Comm 50–64 specify different requirements than those contained in this subchapter, the requirements of this subchapter shall govern.

(3) VARIANCE. Where explicit conformance with the rules of this subchapter is not attained, the department will consider and may grant a variance as specified in s. Comm 50.25. The department will consider the results obtained from nationally recognized evaluation procedures (for example, Fire Safety Evaluation System (FSES) as specified in Appendix C of the National Fire Protection Association (NFPA) Life Safety Code 101–1981) in evaluating requests for variance.

Special Note: The purpose of this subchapter is to eliminate conflicting rules between department of commerce and department of health and family services (DHFS). DHFS is involved with the enforcement of the federal requirements for the Title XVIII (Medicare) and Title XIX (Medicaid) programs. Since the basis of the federal program for construction purposes is compliance with the NFPA, 101 Life Safety Code, the rules of this subchapter reflect the rules of the NFPA, 101 Life Safety Code, 1981 edition.

History: Cr. Register, December, 1981, No. 312, eff. 1–1–82; cr. (2) (c), Register, October, 1982, No. 322, eff. 11–1–82.

Part 2 — General Requirements

Comm 58.01 Class of construction. (1) TWO OR MORE STORIES. Except as provided in par. (d), all health care facilities 2 or more stories in height shall be of fire-resistive type 1 construction as specified in s. Comm 51.03 (1) with the following modifications:

(a) *Floor framing support assemblies.* Floor framing support assemblies shall have a minimum fire-resistive rating of 2 hours.

(b) *Roof assemblies.* Roof assemblies shall have a minimum fire-resistive rating of 1½ hours.

(c) *Exterior bearing walls.* All exterior bearing walls shall have a minimum fire-resistive rating of 3 hours.

(d) Health care facilities up to and including 3 stories in height may be of Type 3 construction if completely protected by an approved automatic fire sprinkler system.

(2) ONE-STORY CONSTRUCTION. (a) *Hospitals.* 1. Except as provided in subd. 2., one story hospitals shall be of type 3 metal

frame protected construction or better as specified in Table 51.03-A with the following specifications:

a. Roof framing assemblies for types 1, 2 and 3 construction shall have a minimum fire-resistive rating of one hour.

b. All exterior bearing walls of type 3 construction shall have a minimum fire-resistive rating of one hour.

2. One story hospitals provided with a complete automatic fire sprinkler system installed in accordance with s. Comm 51.23 may be of type 7, wood frame protected construction or better as specified in Table 51.03-A.

(b) *Nursing homes.* One story nursing homes shall be of type 7 wood frame protected construction or better as specified in Table 51.03-A.

History: Cr. Register, December, 1981, No. 312, eff. 1-1-82; am. (2) (a) 2., Register, October, 1982, No. 322, eff. 11-1-82; am. (1) (a), r. and recr. (2), Register, December, 1983, No. 336, eff. 1-1-84; am. (1) (intro.) and cr. (1) (d), Register, August, 1985, No. 356, eff. 1-1-86.

Comm 58.02 Occupancy separations and hazard enclosures. Occupancies within the scope of this chapter shall be separated from other occupancies or uses in accordance with s. Comm 51.08. Hazards shall be enclosed in accordance with s. Comm 51.08.

History: Cr. Register, December, 1981, No. 312, eff. 1-1-82; am. (3) (a), Register, October, 1982, No. 322, eff. 11-1-82; am. (4), Register, December, 1983, No. 336, eff. 1-1-84; cr. (5), Register, August, 1985, No. 356, eff. 1-1-86; r. and recr., Register, March, 1991, No. 423, eff. 4-1-91; r. and recr., Register, December, 1995, No. 480, eff. 4-1-96; r. and recr. Register, March, 1997, No. 495, eff. 4-1-97.

Comm 58.03 Windows. (1) OUTSIDE WINDOWS. Every habitable room shall be provided with outside windows having a total glazed area of at least 8% of the floor area of the room. The bottom of the window opening in sleeping rooms shall be not more than 36 inches above the floor.

(2) **VENTILATION.** (a) *Where required.* Every patient sleeping room and every habitable room shall have an outside window or outside door located so it can be opened from the inside to permit the venting of products of combustion and to permit any occupant to have direct access to outside air in case of an emergency. Where windows require the use of tools or keys for operation, written approval from the department shall be obtained. The keys or tools shall be accessible to staff and located on each floor having such windows.

(b) *Openable area of outside windows.* The openable area of outside windows shall be equal to at least 4% of the floor area served, except as follows:

1. Rooms intended for occupancy for less than 24 hours, such as those housing obstetrical labor beds, recovery beds, observation beds in emergency department and newborn nurseries;

2. Rooms where persons are forcibly confined, such as psychiatric wards, alcohol and drug abuse areas or other similar areas of protective placement; or

3. Buildings designed with an engineered smoke control system as specified in NFPA 90A, Standard for the Installation of Air Conditioning and Ventilating Systems.

History: Cr. Register, December, 1981, No. 312, eff. 1-1-82; am. (1), Register, January, 1994, No. 457, eff. 2-1-94.

Part 3 - Means of Egress Requirements

Comm 58.04 Required means of egress. (1) GENERAL. All required means of egress shall comply with the requirements as specified in s. Comm 51.15, except as modified in this section.

(2) **EXIT DOORS.** (a) *Width.* All exit doors shall be not less than 44 inches and not more than 48 inches in width, except that doors serving enclosed stairways may be a minimum of 36 inches in width.

(b) *Door swing.* A door which is used by 25 persons or less shall not be required to open in the direction of egress.

(c) *Force to open door.* The force required to fully open doors shall not exceed 37 pounds applied to the latch side.

(d) *Door platforms.* The floor on both sides of an exit door, except as specified in s. Comm 51.16 (4) (c), shall be at the same elevation and be level for a distance at least the width of the door, or as specified in s. Comm 52.04.

(3) **EXIT ACCESS DOORS.** (a) *Width.* 1. All exit access doors from hospital and nursing home sleeping rooms; patient or resident use areas; diagnostic and treatment areas, such as x-ray, surgery, or physical therapy; and all doors between these spaces and the required exits shall be at least 44 inches wide.

2. Exit access doors not subject to use by patients, shall be at least 36 inches wide.

(b) *Door swing.* A door which is used by not more than 25 persons shall not be required to open in the direction of egress.

History: Cr. Register, December, 1981, No. 312, eff. 1-1-82; am. (2) (b), Register, October, 1982, No. 322, eff. 11-1-82.

Comm 58.05 Number and type of exits. (1) NUMBER. At least 2 exits, located remote from each other, shall be provided from each floor and fire section of the building.

(2) **TYPE OF EXITS.** (a) At least one exit from each floor or smoke compartment shall be by a door leading directly to a stairway, smokeproof tower, ramp, horizontal exit, exit passageway, or to the outside of the building as specified in this subchapter.

(b) No more than one-half of the required exits shall be horizontal exits.

History: Cr. Register, December, 1981, No. 312, eff. 1-1-82; am. (2) (a), Register, January, 1994, No. 457, eff. 2-1-94.

Comm 58.06 Stairs. (1) STAIR DETAILS. All stairs shall comply with the requirements specified in ss. Comm 51.16 and 51.164, except as modified in this section.

(a) All stairways and steps shall conform to the requirements of ss. Comm 51.16 to 51.166, except that steps shall have a rise of not less than 4 inches measured from tread to tread, and treads shall be solid.

(b) Every landing or platform shall be at least as wide as the stairway, measured at right angles to the direction of travel. The length of every landing or platform shall be at least as wide as the stairway. The length of the landing or platform need not exceed 48 inches.

(c) The aggregate width for stairways shall comply with the requirements specified in s. Comm 58.12.

(2) **ENCLOSURE.** (a) All stairways shall be enclosed as specified in s. Comm 51.18.

(b) Stairways in addition to those required by these rules, need not lead to the outside, but shall comply with the enclosure requirements.

(c) Nonrequired stairways and ramps connecting different levels within the same floor as defined in s. Comm 51.01 (56a) are not required to be enclosed.

History: Cr. Register, December, 1981, No. 312, eff. 1-1-82; am. (1) (a) and (2) (a), Register, October, 1982, No. 322, eff. 11-1-82; r. and recr. (1) (a), Register, December, 1983, No. 336, eff. 1-1-84; cr. (2) (c), Register, August, 1985, No. 356, eff. 1-1-86; am. (1) (a) and (2) (c), Register, January, 1994, No. 457, eff. 2-1-94.

Comm 58.07 Handrails. Handrails shall be provided as specified in s. Comm 51.161, except that handrails protecting the open sides of stairways and ramps shall have intermediate rails or an ornamental pattern designed to prevent the passage of an object with a diameter larger than 6 inches.

History: Cr. Register, December, 1981, No. 312, eff. 1-1-82; am. Register, August, 1985, No. 356, eff. 1-1-86.

Comm 58.08 Guardrails. Guardrails shall be provided as specified in s. Comm 51.162, except that guardrails shall have intermediate rails or an ornamental pattern designed to prevent the passage of an object with a diameter larger than 6 inches.

History: Cr. Register, December, 1981, No. 312, eff. 1-1-82.

Comm 58.09 Smokeproof towers. Smokeproof stair towers shall comply with the requirements specified in ss. Comm 51.17, 58.04 and 58.06.

History: Cr. Register, December, 1981, No. 312, eff. 1-1-82.

Comm 58.10 Horizontal exits. (1) GENERAL. Horizontal exits shall comply with the requirements specified in s. Comm 51.19, except as modified in this section.

(2) **AREA.** At least 30 net square feet per occupant in a facility shall be provided within areas such as corridors, patient rooms, treatment rooms, lounge or dining areas on each side of the horizontal exit for the total number of people in the adjoining compartment.

(3) **DOORS.** (a) A single door used as a horizontal exit shall serve one direction only, be at least 44 inches wide, swing in the direction of egress and comply with the requirements specified in s. Comm 58.21.

(b) A horizontal exit in a corridor 8 feet or more in width serving as a means of egress from both sides of the doorway shall have the opening protected by a pair of swinging doors, arranged to swing in the opposite direction from the other, with each door being at least 44 inches wide.

(c) Center mullions are prohibited.

(d) A vision panel, complying with the requirements specified in s. Comm 51.048 and not exceeding 100 square inches, shall be provided in each horizontal exit door. Vision panels shall be set in steel frames and shall be tested as part of the entire rated door assembly.

(4) **RESTRICTIONS.** If a horizontal exit is used as a smoke barrier it shall comply with the requirements specified in s. Comm 58.30.

History: Cr. Register, December, 1981, No. 312, eff. 1-1-82; am. (2), Register, December, 1983, No. 336, eff. 1-1-84.

Comm 58.11 Ramps. (1) MINIMUM WIDTH. (a) *Interior ramps.* Interior ramps shall be a minimum of 44 inches wide, of which not more than 4 inches on each side may be occupied by a handrail.

(b) *Exterior ramps.* Exterior ramps shall be a minimum of 48 inches wide of which not more than 4 inches on each side may be occupied by a handrail.

(2) **SLOPE.** Ramps shall have a slope of not more than 1 foot of rise in 12 feet of run.

(3) **ENCLOSURE.** Ramps used as a required means of egress and that connect different floors shall comply with the enclosure requirements for stairways specified in s. Comm 58.06 (2).

(4) **LANDINGS AND PLATFORMS.** (a) If a door is provided at the top or bottom or both of a ramp, a landing or platform shall be placed between the door and the ramp regardless of the direction of swing of the door.

(b) Every landing or platform shall be at least as wide as the ramp, measured at right angles to the direction of travel. The length of every landing or platform shall be at least as wide as the ramp, but need not exceed 48 inches.

History: Cr. Register, December, 1981, No. 312, eff. 1-1-82; cr. (4), Register, December, 1983, No. 336, eff. 1-1-84; am. (3), Register, August, 1985, No. 356, eff. 1-1-86.

Comm 58.12 Capacity of means of egress.

(1) **OCCUPANT LOAD.** (a) *Capacity.* The occupant load for which means of egress shall be provided for any floor shall be the maximum number of persons to occupy that floor, but not less than one person for each 120 square feet gross floor area.

(b) *Exits serving more than one floor.* Where exits serve more than one floor, only the occupant load of each floor considered individually need to be used in computing the capacity of the exits at that floor, provided the exit capacity is not decreased in the direction of exit travel.

(2) **REQUIRED EXIT WIDTH.** (a) *Units of exit width.* The required exit width shall be measured in units of exit width of 22 inches. Fractions of a unit less than 12 inches shall not be counted. Fractions of a unit 12 inches or more, added to one or more full units, shall be counted as $1\frac{1}{2}$ unit of exit width.

(b) *Clear width.* The clear width of the means of egress shall be measured at the narrowest point of the exit component under consideration, except as provided below:

1. The exit width for doorways shall be the measured width of each door leaf;

2. A handrail may project inside the measured width on each side not more than 4 inches; or

3. A stringer may project inside the measured width on each side not more than $1\frac{1}{2}$ inches.

(3) **CAPACITY PER UNIT OF EXIT WIDTH.** (a) *Stairways.* The capacity of means of egress providing travel by means of stairs shall be 22 persons per exit unit, except that in buildings protected with a complete automatic sprinkler system the capacity shall not exceed 35 persons per exit unit.

(b) *Horizontal travel.* The capacity of means of egress providing horizontal travel, such as doors, ramps, or horizontal exits shall be 30 persons per exit unit, except that in buildings protected with a complete automatic sprinkler system the capacity shall not exceed 45 persons per exit unit.

History: Cr. Register, December, 1981, No. 312, eff. 1-1-82.

Comm 58.13 Arrangement of means of egress.

(1) **PATIENT SLEEPING.** Every patient sleeping room shall have an exit access door leading directly to an exit access corridor, except as provided below:

(a) If there is an exit door opening directly to the outside from the room at ground level; or

(b) One adjacent room, such as a sitting room or anteroom, may intervene, if all doors along the means of egress are equipped with nonlockable hardware, except as specified in s. Comm 51.15 (3), and if the intervening room is not used to serve as an exit access for more than 8 patient sleeping beds.

(2) **CORRIDORS.** Every aisle, corridor and hallway shall provide access to at least 2 exits complying with the requirements specified in s. Comm 58.05.

(a) *Dead end corridor.* Every exit or exit access shall be so arranged that no corridor, aisle or passageway has a pocket or dead end exceeding 30 feet.

(b) *Exit access corridors.* 1. Every aisle, corridor and hallway used for exit access shall be at least 8 feet in clear and unobstructed width of which not more than 4 inches on each side may be occupied by a handrail.

2. Where doors are placed in the exit access corridor, they shall be a pair of doors, each at least 44 inches in width. Where the exit access corridor serves as a means of egress from both sides of the doorway, the doors shall be arranged to swing in the opposite direction from the other.

(c) *Areas not intended for patient use.* Aisles, corridors and hallways in areas not intended for the housing, treatment or use of patients shall be at least 44 inches in clear and unobstructed width.

(3) **SUITE EXITING.** Any room, suite of rooms, space or area more than 1,000 square feet in area, shall have at least 2 exit access doors remote from each other.

History: Cr. Register, December, 1981, No. 312, eff. 1-1-82; am. (2) (a), Register, December, 1983, No. 336, eff. 1-1-84; renum.(2) (a) and (b) to be (2) (b) and (c), cr. (2) (a), r. (3), renum.(4) to be (3), Register, August, 1985, No. 356, eff. 1-1-86.

Comm 58.14 Measurement of travel distance to exits. All exits of health care facilities shall be located to provide remote means of egress.

(1) **EXIT ACCESS TO AN EXIT.** Travel distance measured along passageways between any room door required as an exit access and an exit shall not exceed 100 feet, except that in buildings protected with a complete automatic sprinkler system the distance shall not exceed 150 feet.

(2) **ROOM TO AN EXIT.** Travel distance measured along passageways between any point in a room and an exit shall not exceed 150 feet, except that in buildings protected with a complete automatic sprinkler system the distance shall not exceed 200 feet.

(3) **SLEEPING ROOM TO AN EXIT ACCESS.** Travel distance measured along passageways between any point in a health care sleeping room or suite and an exit access door to that room or suite shall not exceed 50 feet.

History: Cr. Register, December, 1981, No. 312, eff. 1-1-82.

Comm 58.15 Discharge from exits. All required ramps or stairs serving as exits shall discharge directly to the outside at grade or be arranged to travel through an exit passageway discharging to the outside at grade. Unenclosed exterior ramps or stairways may not be used as required exits as specified in s. Comm 58.04.

History: Cr. Register, December, 1981, No. 312, eff. 1-1-82; am. Register, August, 1985, No. 356, eff. 1-1-86.

Comm 58.16 Illumination of means of egress. (1) **ILLUMINATION.** Artificial lighting shall be provided at all exits and for such period of times as required to maintain safe exiting.

(2) **ILLUMINATION LEVEL.** The floors of means of egress shall be illuminated at all points including angles and intersections of corridors and passageways, stairways, landings of stairs and exit doors to the values specified in ch. Comm 73.

History: Cr. Register, December, 1981, No. 312, eff. 1-1-82; correction in (2) made under s. 13.93 (2m) (b) 7., Stats., Register, December, 1995, No. 480.

Comm 58.17 Emergency lighting. Emergency lighting shall comply with the requirements specified in ch. Comm 16.

History: Cr. Register, December, 1981, No. 312, eff. 1-1-82.

Comm 58.18 Marking of means of egress. (1) **EXIT SIGNS.** Every required exit shall be identified with an internal illuminated, red or green exit sign bearing the word "EXIT" or "OUT" in plain letters not less than 6 inches high, with the principal strokes of letters not less than $\frac{3}{4}$ inches.

(2) **DIRECTIONAL SIGNS.** An illuminated sign, not less than 6 inches high, reading "EXIT" or similar designation, with an arrow indicating the direction, shall be placed in every location where the direction of travel to reach the nearest exit is not immediately apparent.

(3) **OBSTRUCTIONS.** (a) Decorations, furnishings or equipment which impair visibility of an exit sign shall not be permitted. Displays, objects in or near the line of vision to the required exit sign or brightly illuminated signs used for purposes other than exits shall not be permitted so as to detract attention from the exit sign.

(b) Hangings or draperies shall not be placed over exit doors or be located as to conceal or obscure any exit. Mirrors shall not be placed on exit doors. Mirrors shall not be placed in or adjacent to any exit in such a manner as to confuse the direction of exit.

(4) **SPECIAL SIGNS.** Any door, passage, or stairway which is neither an exit nor a way of exit access, and which is located or arranged that it may be mistaken for an exit, shall be identified by a sign indicating it is not an exit.

History: Cr. Register, December, 1981, No. 312, eff. 1-1-82; am. (1), Register, December, 1995, No. 480, eff. 4-1-96; r. and recr. (1), Register, March, 1997, No. 495, eff. 4-1-97.

Comm 58.19 Headroom. Every means of egress shall be provided with a ceiling clearance of not less than 7 feet 6 inches.

History: Cr. Register, December, 1981, No. 312, eff. 1-1-82.

Comm 58.20 Key locking hardware. Key locking hardware on exit doors and exit access doors is prohibited except in areas accommodating residents who must be detained for their protection and the protection of the general public and the building complies with the requirements of ch. Comm 58, subchs. I and II. Where the requirements of the 2 subchapters differ, the additional or more stringent requirement shall govern.

History: Cr. Register, December, 1981, No. 312, eff. 1-1-82; r. and recr. Register, December, 1983, No. 336, eff. 1-1-84.

Part 4 - Protection

Comm 58.21 Protection of openings. (1) **DOORS.** Doors protecting openings in occupancy separations, smoke barriers, or horizontal exits shall be fire-resistive door assemblies as specified in s. Comm 51.047.

(2) **CLOSING DEVICE.** Doors protecting such openings shall be equipped with a closing device and shall normally be kept closed, except the doors may be held open by a hold open device actuated by products of combustion other than heat. The closing device shall be arranged such that the activation of any one or all of the following systems will initiate the self-closing action of all such doors:

- (a) Manual fire alarm system;
- (b) Automatic smoke detection system or a local device designed to detect smoke on either side of the opening; and
- (c) Automatic sprinkler system or fire detection system, if provided.

History: Cr. Register, December, 1981, No. 312, eff. 1-1-82; am. (1), (2) (intro.) and (c), Register, December, 1983, No. 336, eff. 1-1-84.

Comm 58.22 Elevator lobby enclosures. **History:** Cr. Register, December, 1981, No. 312, eff. 1-1-82; am. Register, December, 1983, No. 336, eff. 1-1-84; r. and recr. Register, August, 1985, No. 356, eff. 1-1-86; r. Register, March, 2000, No. 531, eff. 4-1-00.

Comm 58.23 Protection of vertical openings.

(1) **INTERIOR SHAFTS.** Every elevator shaft, dumbwaiter shaft, pipe shaft and other similar vertical shaft in buildings, shall be enclosed as specified in Table 51.03-A, except as provided in pars. (a) and (b):

- (a) One-hour rated enclosures are permitted in hospitals of type 3 construction; or
- (b) Duct penetrations of floor assemblies which are protected as specified in NFPA 90A.

(2) **ESCALATORS.** All escalators shall be enclosed as specified in s. Comm 58.06 (2).

History: Cr. Register, December, 1981, No. 312, eff. 1-1-82; am. (1) (intro.), Register, October, 1982, No. 322, eff. 11-1-82; am. (1) (b), Register, January, 1994, No. 457, eff. 2-1-94.

Comm 58.24 Protection from hazards. (1) **SEPARATIONS.** All hazards listed in Table 58.24 shall be vertically separated from other areas of the building with fire-resistive rated construction as specified in Table 58.24. All openings shall be

protected with fire-resistive door assemblies as specified in s. Comm 51.047.

TABLE 58.24

HAZARDS	FIRE-RESISTIVE RATING IN HOURS
†Soiled Linen Rooms	1
Kitchens ¹	1
Handicraft Shops ¹	1
†Carpenter Shops	1
Repair Shops ¹	1
†Paint Shops	1
†Trash Collection Rooms	1
†Storage Rooms (containing quantities of flammable or combustible material exceeding 1 lb. of material per square foot of floor area)	1
Gift Shops ¹	1
†Laboratories (containing quantities of flammable or combustible material exceeding 1 lb. of material per square foot of floor area)	1
— All other laboratories ¹	1
Employee Locker Rooms ¹	1

†These areas are required to be protected with an automatic sprinkler system in addition to the fire-resistive enclosure requirements specified in the table.

¹The minimum hourly ratings specified may be reduced to a smoke separation with a self-closing door in buildings protected by a complete automatic sprinkler system.

(2) FIREPLACES. Fireplaces shall be permitted in health care facilities provided:

(a) The fireplace is installed and used in areas other than patient sleeping areas which are separated from the patient sleeping areas by construction having at least a one-hour fire-resistive rating;

(b) The fireplace is equipped with safety screens and a heat tempered glass fireplace enclosure capable of withstanding temperatures of 650°F; and

(c) Combustion air for the fireplace is taken directly from outside the building.

History: Cr. Register, December, 1981, No. 312, eff. 1-1-82; am. Table 58.24-B, Register, October, 1982, No. 322, eff. 11-1-82; am. (1) and (2), cr. (3), r. and recr. Table 58.24-A, am. Table 58-24-B, Register, December, 1983, No. 336, eff. 1-1-84; r. (1), Table 58.24-A, renum. (2) to (1) and am., Table 58.24-B to Table 58.24, (3) to (2), Register, December, 1995, no. 480, eff. 4-1-96; r. and recr. Register, March, 1997, No. 495, eff. 4-1-97.

Comm 58.25 Rubbish chutes and laundry chutes.

(1) VERTICAL PROTECTION. Any rubbish chute or laundry chute shall be enclosed with walls or partitions of at least 2-hour fire-resistive construction specified in s. Comm 51.043, except that horizontal portions of pneumatic rubbish and laundry chute systems need not be enclosed. All openings shall be protected with fire-resistive door assemblies as specified in ss. Comm 51.047 and 58.21 (2), and shall include the opening from the chute into the collection room.

(a) All rubbish chutes may discharge into trash collecting rooms, which are used for no other purpose and are enclosed as specified in Table 58.24. The incinerator shall not be directly flue-fed nor shall any floor discharging chute directly connect with the combustion chamber.

(b) All laundry chutes shall discharge into laundry rooms or laundry collecting rooms, which are used for no other purpose and are enclosed as specified in Tables 51.08-2 and 58.24.

(2) SPRINKLER PROTECTION. All rubbish chutes or laundry chutes, including pneumatic rubbish and laundry systems, shall be

provided with automatic sprinkler protection specified in s. Comm 51.23.

(3) FIRE DAMPERS. Fire dampers are required where chutes penetrate 2-hour or better fire-rated floor or wall systems in a horizontal run.

History: Cr. Register, December, 1981, No. 312, eff. 1-1-82; am. (1) (a) and (b), Register, October, 1982, No. 322, eff. 11-1-82; am. (1) (intro.), Register, December, 1983, No. 336, eff. 1-1-84; am. (1) (a), (b), Register, December, 1995, No. 480, eff. 4-1-96; r. and recr. (1) (a) and (b), Register, March, 1997, No. 495, eff. 4-1-97.

Comm 58.26 Interior finish. (1) SCOPE. The requirements of this section apply to the interior finishes and surfaces of a building.

Note: See s. Comm 51.06 for specific requirements pertaining to foam plastics.

(2) WALLS AND CEILINGS. (a) **Materials.** Except as provided in par. (b), all walls and ceilings shall be Class A as specified in s. Comm 51.01 (75a).

Note: See ch. Comm 18 for interior finish for elevator cabs.

(b) **Exceptions.** 1. Walls and ceilings of individual rooms having a capacity of not more than 4 persons may have a Class B interior finish as specified in s. Comm 51.01 (75a).

2. Interior finish not in excess of 10% of the aggregate wall and ceiling areas of any room or space may be Class C materials in occupancies where interior finish of Class A or Class B is required.

(c) **Napped, tufted and looped materials.** Materials such as carpeting having a napped, tufted, looped, or similar surface, when applied on walls or ceilings, shall meet the requirements of Class A interior finish.

(3) FLOORS. All interior finishes of floor materials shall be Class I or better as specified in s. Comm 51.01 (75a).

(a) **Tongue and groove wood flooring.** Tongue and groove wood flooring, one-half inch thick or greater, shall be permitted.

(b) **Floor material.** Floor material, such as carpeting, shall be fire tested with the underlayment used and shall comply with the requirements as specified in ASTM E648-78, Test for Criteria Radiant Flux of Floor Covering Systems Using a Radiant Heat Source.

(4) FIRE RETARDANT PAINTS OR SOLUTIONS. Fire retardant paints or surface applied solutions shall not be used to satisfy the requirements of this section.

History: Cr. Register, December, 1981, No. 312, eff. 1-1-82; cr. and recr. (2), Register, December, 1983, No. 336, eff. 1-1-84.

Comm 58.27 Detection, alarm and communication systems. (1) GENERAL. All required detection and signaling devices and systems shall comply with the requirements of this section.

(a) All such systems shall be tested at least once a week and a record of such tests shall be kept. All system components or equipment shall be restored to normal condition promptly after each test or alarm and shall be maintained in an operable condition.

(b) The system shall be so arranged that the operation of any one station will actuate all devices connected to the system.

(c) A signaling system may be arranged to automatically perform local, incidental control functions to make the premises safer in the event of fire or to make it possible to hear alarm signals. The performance of incidental control functions, such as the release of self-opening or self-closing doors, shutting off supplies of gas, fuel oil, or electrical power, switching on emergency lights, switching off air supply ventilating fans, and other similar functions, shall not in any way impair the effective response of all required alarm indicating devices. The performance of incidental control functions shall not interfere with the power for lighting or for operating elevators.

(2) **FIRE ALARMS.** Every building shall have a manually operated fire alarm system as specified in s. Comm 51.24 and shall comply with the following requirements:

(a) The operation of any fire alarm activating device shall automatically, without delay, accomplish general alarm indication and control functions as specified in sub. (1). Zoned, coded systems may be used.

(b) The fire alarm system shall be arranged to transmit an alarm automatically to the fire department required to serve the area in which the health care facility is located, by the most direct and reliable method approved by local regulations.

(3) **AUTOMATIC SMOKE DETECTION SYSTEM.** (a) Except as provided in par. (b), an approved automatic smoke detection system shall be installed in all corridors in nursing homes. Such systems shall be installed and maintained as specified in NFPA 72 but in no case shall smoke detectors be spaced more than 30 feet apart on center or more than 15 feet from any wall. All automatic smoke detection systems required by this section shall be electrically interconnected to the fire alarm system.

(b) Corridor smoke detection systems are not required on the patient sleeping room floors, where each patient sleeping room is protected by an approved smoke detection system.

(4) **FIRE EXTINGUISHERS.** Portable fire extinguishers shall be provided and maintained as specified in s. Comm 51.22.

History: Cr. Register, December, 1981, No. 312, eff. 1-1-82; am. (3) (a), Register, December, 1983, No. 336, eff. 1-1-84; am. (3) (a), Register, February, 1999, No. 518, eff. 3-1-99.

Comm 58.28 Standpipes. (1) **FIRST-AID STANDPIPES.** First-aid standpipes shall be provided as specified in s. Comm 51.21 for all health care facilities, unless an approved automatic sprinkler system is installed.

(2) **FIRE DEPARTMENT STANDPIPES.** Fire department standpipes shall be provided in all buildings exceeding 60 feet in height and shall comply with the requirements specified in s. Comm 51.21.

History: Cr. Register, December, 1981, No. 312, eff. 1-1-82.

Comm 58.29 Automatic sprinkler and other suppression systems. Automatic sprinkler systems shall comply with the requirements specified in s. Comm 51.23, except as modified in this section.

(1) **WHERE REQUIRED.** (a) *Hospitals.* Automatic sprinkler systems shall be provided as specified in ss. Comm 52.01 and 58.24.

(b) *Nursing homes.* 1. A complete automatic fire sprinkler system shall be provided in all nursing homes constructed after the effective date of this rule.

2. Additions to existing nursing homes shall be provided with a complete automatic fire sprinkler system. The sprinkler protection shall be provided throughout unless the addition is separated from the existing building by at least 2-hour fire-resistive construction in which case only the addition shall be protected by an automatic fire sprinkler system.

(2) **SPRINKLER CONTROL VALVES.** (a) The main sprinkler control valves shall be electrically supervised so that at least a local alarm will sound at a constantly supervised location when the valve is closed.

(b) All valves other than the main sprinkler control valve shall be electrically supervised or secured with a key locking device.

(3) **WATER FLOW SWITCH.** The water flow alarm switch for the automatic sprinkler system shall be electrically interconnected with the fire alarm system.

(4) **PARTIAL AUTOMATIC SPRINKLER SYSTEM.** The sprinkler piping serving no more than 6 sprinklers for any isolated hazardous area, may be connected directly to a domestic water supply system

having a capacity sufficient to provide 0.15 gallons per minute per square foot of floor area throughout the entire enclosed area.

(a) *Indicating shut-off valve.* An indicating shut-off valve shall be installed in an accessible location between the sprinklers and the connection to the domestic water supply.

(b) *Water flow detection.* Where more than 2 sprinklers are installed in a single area, water flow detection shall be provided to sound the building fire alarm system in the event of sprinkler operation.

(5) **OTHER AUTOMATIC SUPPRESSION SYSTEMS.** (a) *Types.* Other automatic suppression systems such as, but not limited to, carbon dioxide, dry chemical, foam and Halon 1301, may be installed in lieu of an automatic water sprinkler system in any occupancy where the extinguishment or control of fire may be more effectively accomplished by this type of automatic suppression system.

(b) *Activation.* These suppression systems shall be installed such that the fire alarm system will sound when the suppression system is activated.

History: Cr. Register, December, 1981, No. 312, eff. 1-1-82; am. (2) (a), Register, December, 1983, No. 336, eff. 1-1-84; am. (1) (b), Register, August, 1985, No. 356, eff. 1-1-86.

Comm 58.30 Smoke barrier. (1) **DEFINITION.** A smoke barrier is a separation wall which is continuous from outside wall to outside wall and from floor slab to the underside of the floor slab or roof slab above, including all concealed spaces such as those found above a ceiling including interstitial spaces.

(2) **FIRE-RESISTIVE RATING.** Smoke barriers shall have a one-hour fire-resistive rating specified in s. Comm 51.043.

(3) **WHERE REQUIRED.** Smoke barriers are required to:

(a) Limit the area on any story to a length and width of not more than 150 feet;

(b) Divide every story into at least 2 compartments; and

(c) Enclose elevator lobbies on each floor.

(4) **DOORS.** (a) Corridor openings in smoke barriers shall be protected by a pair of swinging doors, each door to swing in a direction opposite from the other. Each door shall have a minimum width of 44 inches, except corridor openings in areas not intended for the housing, treatment, or use of patients may be protected by a single door having a minimum width of 36 inches.

(b) Doors in smoke barriers shall be self-closing and have at least a 20 minute fire-resistive rating, except doors may be held open as specified in s. Comm 58.21.

(c) Door louvers and grills are prohibited. Doors may be undercut to a maximum of $\frac{3}{4}$ inches.

(d) A vision panel complying with the requirements of s. Comm 51.048 and not exceeding 1,296 square inches in area, shall be provided in each door in a smoke barrier and shall be set in steel frames. The bottom of the vision panel shall be located not more than 40 inches off the floor.

(e) Rabbits, bevels, or astragals are required at the meeting edges, and stops are required on the head and sides of door frames. Positive latching hardware is not required.

(f) Center mullions are prohibited.

(5) **DAMPERS.** An approved damper designed to resist the passage of smoke shall be provided at each point a duct penetrates a smoke barrier. The damper shall close upon detection of smoke by an approved smoke detector, located within the duct except that:

(a) The approved damper, if located above a smoke barrier door, may be arranged to close upon detection of smoke by the local device designed to detect smoke on either side of the smoke barrier door opening.

(b) Buildings designed with an engineered smoke control system as specified in NFPA 90A, Standard for the Installation of Air

Conditioning and Ventilating Systems, need not comply with this requirement.

(6) **VISION PANELS.** (a) Except as provided in par. (b), fixed wire glass vision panels shall be permitted in smoke barrier walls, provided the vision panels do not exceed 1,296 square inches in area. The vision panels shall have bolted steel frames and the glazing material shall be listed by an approved testing laboratory.

(b) Vision panels shall not be restricted in area and in fire resistance of glass or frames in buildings equipped throughout with an approved automatic extinguishing system.

History: Cr. Register, December, 1981, No. 312, eff. 1-1-82.

Comm 58.31 Construction of corridor walls.

(1) **FIRE-RESISTIVE RATING.** Except as otherwise provided in this section, corridors shall be separated from all other areas by partitions which are continuous from the floor slab to the underside of the roof or floor slab above, through any concealed spaces such as those above suspended ceilings, and through interstitial structural and mechanical spaces, and shall have at least a one-hour fire-resistive rating as specified in s. Comm 51.043.

(a) In health care facilities equipped throughout with an approved automatic extinguishing system, a corridor may be separated from all other areas by nonfire-rated partitions, and where suspended ceilings are provided, the partitions may be terminated at the suspended ceiling.

(b) Corridor partitions may terminate at ceilings which are not an integral part of a floor construction if there is at least 5 feet of space between the top of the ceiling subsystem and the bottom of the floor or roof above provided:

1. The ceiling is of membrane type with a finish rating of 15 minutes;
2. Corridor partitions form smoke-tight joints with the ceilings (joint filler, if used, must be noncombustible);
3. Each compartment of interstitial space which constitutes a separate smoke area is vented, in case of smoke emergency, to the outside by mechanical means having a capacity to provide at least 2 air changes per hour, but in no case having a capacity less than 5,000 cfm;
4. The interstitial space shall not be used for storage; and
5. The space shall not be used as a plenum for supply, exhaust or return air except as provided in subd. 3.

(c) Waiting areas on a patient sleeping floors may be open to the corridor, provided:

1. The area does not exceed 250 square feet;
2. The area is located to permit direct supervision by the facility staff;
3. The area is equipped with an electrically supervised automatic smoke detection system installed as specified in s. Comm 58.27; and
4. Not more than one such waiting area is permitted in each smoke compartment.

(d) Waiting areas on floors other than institutional sleeping floors may be open to the corridor, provided:

1. Each area does not exceed 600 square feet;
2. The area is located to permit direct supervision by the facility staff;
3. The area is arranged not to obstruct any access to required exits;
4. The area is equipped with an electrically supervised, automatic smoke detection system installed as specified in s. Comm 58.27.

(e) Buildings equipped throughout with an approved automatic sprinkler system may have spaces open to the corridor which are unlimited in size provided:

1. The spaces are not used for patient sleeping rooms, treatment rooms or hazardous areas;

2. Each space is located to permit direct supervision by the facility staff;

3. The space and corridors which the space opens onto in the same smoke compartment are protected by an electrically supervised automatic smoke detection system installed as specified in s. Comm 58.27; and

4. The space is arranged not to obstruct access to required exits.

(f) Space for doctors' and nurses' charting, communications, and related clerical areas may be open to the corridor.

(2) **VISION PANELS.** (a) Fixed wire glass vision panels shall be permitted in corridor walls provided they do not exceed 1,296 square inches in area and comply with the requirements specified in s. Comm 51.048.

(b) Vision panels shall not be restricted in area and in fire resistance of glass or frames in buildings equipped throughout with an approved automatic extinguishing system.

(3) **DOORS.** Except as otherwise provided in this subsection, doors protecting corridor openings, other than required enclosures of exits or hazardous areas, shall have a 20-minute fire-resistive rating and be provided with latches. Fixed wire glass vision panels installed in these doors shall not exceed 720 square inches in area and shall be mounted in approved steel frames.

(a) In buildings equipped with a complete approved automatic sprinkler system:

1. Such doors and frames are not required to have a fire-resistive rating, but shall be constructed to resist the passage of smoke;
2. Such doors are provided with latches of a type suitable for keeping the door tightly closed; and
3. There is no restriction on the area of vision panels in these doors, the vision panels do not need to be wired, and there is no restriction in the type of frames.

(b) Door closing devices are not required on doors in corridor wall openings, other than those exits or required enclosures of hazardous areas.

(c) Labeled door frames are not required on openings other than those serving exits or required enclosures of hazardous areas, providing the door frames and stops are of steel construction.

(d) Doors to toilet rooms, bathrooms, shower rooms, sink closets, and similar auxiliary spaces which do not contain flammable or combustible materials need not comply with this section.

(4) **TRANSFER GRILLS.** Transfer grills shall not be used in these walls or doors, except doors to toilet rooms, bathrooms, shower rooms, sink closets and similar auxiliary spaces which do not contain hazardous quantities of flammable or combustible materials may have ventilating louvers or may be undercut.

History: Cr. Register, December, 1981, No. 312, eff. 1-1-82.

Part 5 - Sanitary Facilities

Comm 58.32 Sanitary facilities. (1) TOILET ROOMS. Every building included under the scope of this subchapter shall be provided with separate toilet rooms for each sex, and shall comply with the requirements as specified in this section and:

- (a) Sections Comm 52.50 (2) (b) to 52.62; and
- (b) Section Comm 52.04.

(2) **SANITARY FIXTURES.** (a) *Patients.* The number of fixtures required for each sex shall comply with the ratios as specified in Table 58.32.

(b) *Employees.* The number of fixtures for employees shall comply with the requirements as specified in Table 54.12-B.

(c) *General public.* The number of fixtures for the general public shall comply with the requirements as specified in Table 54.12-A and s. Comm 52.04.

Note: See ch. HFS 124—Hospitals and ch. HFS 132—Nursing Homes, for special requirements and locations for water closets, lavatories and bathing facilities.

TABLE 58.32
NUMBER OF SANITARY FIXTURES REQUIRED FOR
RESIDENTS OF HEALTH CARE FACILITIES^{1,2}

Type of Occupancy	Type of Fixture			
	Water Closets (WC)	Lavatories (L)	Bathtubs or Showers	Drinking Facilities (DF)
Nursing Homes	One (WC) per every 2 patient rooms and not more than 4 beds	One (L) per every 2 patient rooms and not more than 4 persons per each (L)	One per each 20 patients or fraction	One (DF) for each 100 persons
Hospitals	One (WC) per every 2 patient rooms and not more than 4 beds	One (L) per every 2 patient rooms and not more than 4 persons per each (L)	One per each 15 patients or fraction	One (DF) for each 100 persons

¹ For structures with additions or alterations, the required number of sanitary fixtures shall be the sum of the fixtures required for the existing portion at the time it was constructed plus the fixtures required by this table for the new addition or altered area. At such time as the summation of the addition and alteration area is equal to or greater than 51% of the building area calculated as specified in s. Comm 50.03 (4) (d), fixtures shall be provided in conformance to this table utilizing the capacity of the entire building.

² Where a single toilet room designated as UNISEX is provided, it shall be considered as accommodating no more than 10 employees and 25 occupants.

History: Cr. Register, December, 1981, No. 312, eff. 1-1-82; r. and recr. Register, August, 1993, No. 452, eff. 3-1-94.

Subchapter II — Detention and Correctional Facilities

Part 1 — Scope

Comm 58.40 Scope. The requirements of this subchapter shall apply to all detention and correctional facilities, constructed on or after January 1, 1982.

History: Cr. Register, December, 1981, No. 312, eff. 1-1-82.

Comm 58.41 Definitions. For the purpose of this subchapter, the following terms are defined:

(1) "Borrowed light" means an opening in an interior partition which provides natural light to an interior space.

(2) "Dayroom" means any room used as a group activity space and located contiguous to the sleeping rooms.

(3) "Detention and correctional facilities" means any building or part of a building used for purposes such as jails, detention centers, correctional institutions, reformatories, houses of correction, pre-release centers, and other residential care facilities where occupants are forcibly confined.

(4) "Holding room" means any room used for confining persons for a maximum of 72 hours for the purpose of booking, court appearances and similar type functions.

(5) "Program support facility" means any detention or correctional facility, other than sleeping areas, containing only those facilities such as schools, theaters, assembly halls, shops, gyms, offices, medical facilities, food service and dining facilities, laundries, gatehouses and other similar facilities, where the occupancy of these areas is primarily residents or detention staff or both.

(6) "Smoke barrier" means a separation wall which extends continuously from outside wall to outside wall and from the floor to the underside of the floor slab or roof slab above, including all concealed spaces such as those found above a ceiling including interstitial spaces.

(7) "Smoke compartment" means a space within a building enclosed by smoke barriers on all sides.

(8) "Security vestibule" means a compartment provided with 2 or more doors with the intended purpose to prevent the continu-

ous and unlimited passage by allowing the release of only one door at a time.

History: Cr. Register, December, 1981, No. 312, eff. 1-1-82; am. (4), Register, December, 1983, No. 336, eff. 1-1-84.

Part 2 — General Requirements

Comm 58.42 Class of construction. (1) BUILDINGS OR PORTIONS OF BUILDINGS WITH SLEEPING ROOMS. All detention and correctional facilities containing sleeping facilities or holding rooms or both shall be at least type 2 construction as specified in s. Comm 51.03.

(2) PROGRAM SUPPORT FACILITIES. All program support facilities shall be constructed in accordance with the following:

(a) *One-story building.* All buildings one-story in height shall be at least type 6, totally non-combustible construction as specified in s. Comm 51.03.

(b) *Two-stories or more in height.* All buildings 2-stories or more in height shall be at least type 2 construction as specified in s. Comm 51.03.

History: Cr. Register, December, 1981, No. 312, eff. 1-1-82; am. (1), Register, December, 1983, No. 336, eff. 1-1-84.

Comm 58.43 Program support facilities. All program support facilities shall comply with the specific occupancy chapter requirements as specified in chs. Comm 54 to 62, except as modified in ss. Comm 58.59 and 58.64.

History: Cr. Register, December, 1981, No. 312, eff. 1-1-82.

Comm 58.44 Separation from other occupancies and hazard enclosures. (1) OCCUPANCY SEPARATION. Occupancies not within the scope of this subchapter, built in connection with any detention or correctional facility shall be separated from any such detention or correctional facility in accordance with s. Comm 51.08. Auditoriums, chapels, dining rooms, residential facilities and other similar areas provided for the residents need not be separated with rated construction. Class of construction separations shall comply with s. Comm 51.02 (20).

(2) GARAGES. (a) Storage garages and repair garages shall be separated from detention and correctional facilities as specified in s. Comm 59.22.

(b) Areas accommodating vehicles for the purpose of loading or unloading persons or material need not be separated from detention and correctional facilities. Storage or repair of the

vehicles is prohibited in the loading and unloading areas, unless the type of construction meets the requirements for a garage.

(3) **HAZARD ENCLOSURES.** Hazards shall be enclosed in accordance with s. Comm 51.08

(4) **EXITING FROM MIXED OCCUPANCIES.** Required means of egress from all detention and correctional occupancies may exit through non-detention and non-correctional occupancies provided the means of egress complies with the requirements specified in this subchapter.

History: Cr. Register, December, 1981, No. 312, eff. 1-1-82; am. (2) (a), Register, October, 1982, No. 322, eff. 11-1-82; am. (3), Register, December, 1983, No. 336, eff. 1-1-84; cr. (4), Register, August, 1985, No. 356, eff. 1-1-86; am. (1), (3), Register, December, 1995, No. 480, eff. 4-1-96; r. and recr., Register, March, 1997, No. 495, eff. 4-1-97.

Comm 58.45 Windows. (1) **NATURAL LIGHTING.** Every sleeping room, except holding rooms where residents are detained for a time period not to exceed 72 hours, shall be provided with natural light. The natural light may be provided directly to the sleeping room by windows or sky lights or may be transferred indirectly to the space through the use of borrowed lights. The natural light shall be provided through either clear or translucent glazing with the area of the sash being at least 8% of the floor area served.

(2) **VENTILATION.** Every sleeping room shall be provided with ventilation in accordance with one of the following:

(a) Windows or skylights with an openable area not less than 4% of the floor area served and located within the sleeping room; or

(b) Mechanical ventilation as specified in s. Comm 64.58 (2) and provided with an emergency source of power.

History: Cr. Register, December, 1981, No. 312, eff. 1-1-82; am. (1), Register, October, 1982, No. 322, eff. 11-1-82.

Comm 58.46 Size of sleeping rooms. Every sleeping room shall provide at least 400 cubic feet of space for each occupant. In places of detention, day rooms may be used to satisfy the 400-cubic-foot-per-person volume requirement provided the following criteria are met:

(1) The shared day room space shall be immediately adjacent to the sleeping room and the combined volume of the day room and the sleeping room shall be a minimum of 400 cubic feet per occupant; and

(2) Ventilation shall be provided by one of the following methods:

(a) Natural ventilation shall be based on the ratio of 2 square feet per person of openable windows or skylights. The natural ventilation may be drawn from any openable windows or skylights located accessible to the sleeping room. A minimum of 50% of the vertical plane separating the sleeping room from the day room shall be open, such as may be provided with bars or security grilles.

(b) Mechanical ventilation shall be provided in accord with s. Comm 58.45 (2) (b) if a minimum of 50% of the vertical plane separating the sleeping room from the day room is not open. The sleeping room shall have a minimum of 35 square feet of floor area per person. The floor area shall include all area within the walls of the sleeping room, including the space taken up by beds, lavatories, water closets and furniture.

Note: Section DOC 350.05 requires a ceiling height of at least 8 feet in sleeping rooms, and a floor area of at least 54 square feet in single occupancy cells.

Note: Section DOC 350.07 requires the floor area in double occupancy cells to be at least 70 square feet for jails constructed or substantially remodeled on or after March 1, 1990, and at least 54 square feet for jails constructed before March 1, 1990.

History: Cr. Register, December, 1981, No. 312, eff. 1-1-82; r. and recr. Register, January, 1994, No. 457, eff. 2-1-94.

Comm 58.47 Sleeping rooms below grade. All buildings having sleeping rooms below grade shall be designed and

constructed to prevent penetration or collection of moisture within occupied spaces.

History: Cr. Register, December, 1981, No. 312, eff. 1-1-82.

Part 3 – Means of Egress Requirements

Comm 58.48 Required means of egress.

(1) **GENERAL REQUIREMENTS.** All required means of egress doors shall comply with s. Comm 51.15, except as modified in this section and s. Comm 58.59.

(2) **DOORS IN MEANS OF EGRESS.** (a) Doors in a means of egress may be of the horizontal sliding type, providing the force to slide the door to its fully open position does not exceed 37 pounds.

(b) A door which serves an area with a capacity not more than 25 persons is not required to open in the direction of egress.

(3) **EXIT DISCHARGE.** Exit discharge may terminate at one of the following:

(a) Directly at the exterior of the building;

(b) At a horizontal exit; or

(c) Into a fenced or walled court, provided that not more than 2 walls of the court are the walls of the building from which exit is being made. Enclosed yards or courts shall be sized to accommodate all occupants, a minimum of 30 feet from the building with a net area of 15 square feet per person. Access from the fenced or walled court to the public thoroughfare may be fenced and locked.

(4) **EXIT ACCESS.** A dayroom may serve as a portion of the exit access from a sleeping room.

History: Cr. Register, December, 1981, No. 312, eff. 1-1-82.

Comm 58.49 Exit doors, number and type of exits.

(1) **NUMBER.** At least 2 exits shall be accessible from each floor of the building and shall be located such that in case any exit is blocked, some other exit will still be accessible.

(2) **EXIT DOORS.** All exit doors shall be at least 36 inches in width.

(3) **EXIT ACCESS DOORS.** All exit access doors shall be at least 36 inches in width, except for the following modifications:

(a) Doors to sleeping rooms shall be at least 28 inches in width;

(b) Doors to sleeping rooms designated for use by the physically disabled shall be at least 32 inches in width; or

(c) Doors to dayrooms shall be at least 32 inches in width.

(4) **TYPE OF EXITS.** (a) Required exits shall be by a door leading directly to a stairway, smokeproof tower, ramp, horizontal exit, exit passageway or outside the building as specified in this subchapter. No more than one-half of the required exits may be horizontal exits.

(b) Where a detention or correctional facility, other than a hospital or nursing home, is located on the upper floors of a building having a different occupancy, at least one of the exits from the detention or correctional facility shall be a separate smokeproof tower as specified in s. Comm 51.17. The smokeproof tower shall serve only the detention or correctional facility and there shall be no doors opening into the smokeproof tower from any other occupancy of the building.

History: Cr. Register, December, 1981, No. 312, eff. 1-1-82.

Comm 58.50 Stairways. (1) **GENERAL.** (a) All required exit stairways shall comply with the requirements specified in s. Comm 51.16 and shall be enclosed as specified in s. Comm 51.18.

(b) 1. Except as provided in subd. 2., stairways in addition to those required by this chapter need not lead to the outside but shall be enclosed as required in par. (a).

2. Nonrequired stairways serving open mezzanines need not be enclosed.

(2) **STAIRWAY TERMINATION.** Stairways provided in addition to those required by this subchapter shall be enclosed as specified in s. Comm 51.18 but need not lead to the outside. A sign or label shall be posted on the doors of the stair enclosures and shall bear the following: "Not an Exit".

History: Cr. Register, December, 1981, No. 312, eff. 1-1-82; am. Register, December, 1983, No. 336, eff. 1-1-84; am. (1) (a) and cr. (1) (b), Register, August, 1985, No. 356, eff. 1-1-86.

Comm 58.51 Smokeproof towers. Smokeproof stair towers shall comply with the requirements specified in ss. Comm 51.17 and 58.48.

History: Cr. Register, December, 1981, No. 312, eff. 1-1-82.

Comm 58.52 Horizontal exits. (1) GENERAL. Horizontal exits shall comply with the requirements in s. Comm 51.19, except as modified in this section.

(2) **AREA.** At least 6 net square feet of accessible space per occupant shall be provided on each side of the horizontal exit for the total number of people in the adjoining compartment.

(3) **DOORS.** (a) A single door used as a horizontal exit shall serve one direction only, be at least 36 inches wide and swing in the direction of egress.

(b) Horizontal exit doors may be locked as specified in s. Comm 58.59.

(4) **RESTRICTIONS.** If a horizontal exit is used as a smoke barrier, it shall comply with s. Comm 58.67.

History: Cr. Register, December, 1981, No. 312, eff. 1-1-82.

Comm 58.53 Ramps. (1) MINIMUM WIDTH. (a) Interior ramps. Interior ramps shall be a minimum of 44 inches wide, of which not more than 4 inches on each side may be occupied by a handrail.

(b) **Exterior ramps.** Exterior ramps shall be a minimum of 48 inches wide, of which not more than 4 inches on each side may be occupied by a handrail.

(2) **SLOPE.** Ramps shall have a slope of not more than one foot of rise in 8 feet of run, except ramps providing access for the disabled shall comply with s. Comm 52.04.

(3) **ENCLOSURE.** Ramps used as a required means of egress shall comply with the enclosure requirements for stairways in s. Comm 51.18.

(4) **LANDINGS AND PLATFORMS. (a)** If a door is provided at the top or bottom or both of a ramp, a landing or platform shall be placed between the door and the ramp regardless of the direction of swing of the door.

(b) Every landing or platform shall be at least as wide as the ramp, measured at right angles to the direction of travel. The length of every landing or platform shall be at least as wide as the ramp, but need not exceed 48 inches.

History: Cr. Register, December, 1981, No. 312, eff. 1-1-82; cr. (4), Register, December, 1983, No. 336, eff. 1-1-84.

Comm 58.54 Required exit width. (1) OCCUPANT LOAD. The occupant load for which means of egress shall be provided shall be the maximum number of persons occupying that floor, but not less than one person for each 120 sq. ft. gross floor area.

(2) **REQUIRED EXIT WIDTH.** The required exit width shall comply with s. Comm 51.15 (6).

History: Cr. Register, December, 1981, No. 312, eff. 1-1-82.

Comm 58.55 Arrangement of means of egress. (1) SLEEPING ROOM. Every sleeping room shall have a door leading directly to an exit access, except where an exit door opens directly to the outside from the room at the ground level.

(2) **CORRIDOR ACCESS. (a)** Every aisle, corridor and hallway shall provide access to at least 2 exits complying with s. Comm 58.48.

(b) Every aisle, corridor and hallway used for exit access shall be at least 44 inches in clear and unobstructed width.

(3) **EXIT PASSAGEWAYS.** Every exit passageway shall be at least 44 inches in width.

(4) **AREA EXITING.** Any room, suite of rooms, space or area accommodating 25 persons or more, shall have at least 2 exit access doors distributed to provide the best possible means of egress from the room.

(5) **SECURITY VESTIBULE EXITING.** A security vestibule may be permitted in a means of egress where there are provisions for continuous and unobstructed passage through the security vestibule during an emergency exit condition.

(6) **DEAD END CORRIDOR.** Every exit or exit access shall be so arranged that no corridor, aisle or passageway has a pocket or dead end exceeding 30 feet.

History: Cr. Register, December, 1981, No. 312, eff. 1-1-82; cr. (6), Register, August, 1985, No. 356, eff. 1-1-86.

Comm 58.56 Measurement of travel distance to exits. All exits in detention and correctional facilities shall be located to provide means of egress remote from one another.

(1) **EXIT ACCESS TO AN EXIT.** Travel distance shall be measured along passageways. The distance between any room door required as an exit access and an exit shall not exceed 100 feet, except that in buildings protected with a complete automatic sprinkler system the distance shall not exceed 150 feet.

(2) **ROOM TO AN EXIT.** Travel distance shall be measured along passageways. The distance between any point in a room and an exit shall not exceed 150 feet, except that in buildings protected with a complete automatic sprinkler system the distance shall not exceed 200 feet.

(3) **SLEEPING ROOM TO AN EXIT ACCESS.** Travel distance shall be measured along passageways. The distance between any point in a sleeping room or suite and an exit access door to that room or suite shall not exceed 50 feet.

History: Cr. Register, December, 1981, No. 312, eff. 1-1-82.

Comm 58.57 Illumination of means of egress. (1) ILLUMINATION. Artificial lighting shall be provided at all exits and for such period of times as required to maintain safe exiting.

(2) **ILLUMINATION LEVEL.** The floors of means of egress shall be illuminated at all points including angles and intersections of corridors and passageways, stairs, landings of stairs and exit doors to values specified in ch. Comm 73.

History: Cr. Register, December, 1981, no. 312, eff. 1-1-82; correction in (2) made under s. 13.93 (2m) (b) 7., Stats., Register, December, 1995, No. 480.

Comm 58.575 Emergency lighting. Emergency lighting complying with the requirements specified in ch. Comm 16 shall be required when 20 or more resident beds are provided.

History: Cr. Register, December, 1983, No. 336, eff. 1-1-84.

Comm 58.58 Marking of means of egress. (1) EXIT SIGNS. Every required exit shall be identified with an internal illuminated, red exit sign bearing the word "EXIT" or "OUT" in plain letters not less than 6 inches high, with the principal strokes of the letter not less than $\frac{3}{4}$ inches.

(2) **DIRECTIONAL SIGNS.** An illuminated sign, not less than 6 inches high, reading "EXIT" or similar designation, with an arrow indicating the direction, shall be placed in every location where the direction of travel to reach the nearest exit is not immediately apparent.

(3) **OBSTRUCTIONS.** (a) Decorations, furnishings or equipment which impair visibility of an exit sign shall not be permitted. Displays, objects in or near the line of vision to the required exit sign, or brightly illuminated signs used for purposes other than exits shall not be permitted so as to detract attention from the exit sign.

(b) Hangings or draperies shall not be placed over exit doors or be located as to conceal or obscure any exit. Mirrors shall not be placed on exit doors. Mirrors shall not be placed in or adjacent to any exit in such a manner as to confuse the direction of exit.

(4) **SPECIAL SIGNS.** Any door, passage, or stairway which is neither an exit nor a way of exit access, and which is located or arranged that it may be mistaken for an exit, shall be identified by a sign indicating it is not an exit.

History: Cr. Register, December, 1981, No. 312, eff. 1-1-82.

Comm 58.59 Door locks. All doors in detention and correctional facilities having locking devices shall comply with the following requirements:

(1) **LOCKING OF MEANS OF EGRESS DOORS.** All doors in detention and correctional facilities may be locked in accordance with this section, providing that staff is on duty 24 hours a day.

(a) *Locks at sleeping rooms.* 1. Single sleeping room. A single sleeping room may be key locked.

2. Two or more sleeping rooms. Where 2 or more sleeping rooms within a smoke compartment are locked, a remote locking and unlocking device shall be provided. The remote locking and unlocking device shall be located outside of the sleeping room areas.

(b) *Locks at exterior doors, stairways and horizontal exits.* Doors from the secured areas to the exterior of the building, into stairway enclosures or at horizontal exits may be locked with a key lock. The keys to unlock such doors shall be maintained and available at the facility at all times and the locks shall be operable from the outside.

(2) **REMOTE RELEASE.** All remote release operated doors shall be provided with a back-up means of operation as follows:

(a) Power-operated sliding doors or power operated locks shall be so constructed that in the event of power failure a manual mechanical means to release and open the doors is provided at each door and either emergency power in accordance with ch. Comm 16 is provided for the power operation or a remote manual mechanical release is provided.

(b) Mechanically operated sliding doors or mechanically operated locks shall be provided with a manual mechanical means to release and open the door at the door.

(3) **REMOTE UNLOCKING.** Doors remotely unlocked under emergency conditions shall not automatically relock when closed unless specific action is taken at the remote location to enable doors to relock.

(4) **STANDBY EMERGENCY POWER.** Standby emergency power shall be provided for all electrically power-operated doors and power-operated locks. Power shall be arranged to automatically operate upon failure of normal power within 10 seconds and to maintain the necessary power source for at least 1½ hours.

History: Cr. Register, December, 1981, No. 312, eff. 1-1-82; am. (1) (b), Register, December, 1983, No. 336, eff. 1-1-84; r. and recr. (2), Register, August, 1985, No. 356, eff. 1-1-86.

Part 4 - Protection

Comm 58.60 Protection of openings. (1) **DOORS.** Doors protecting openings in occupancy separations, smoke barriers, or horizontal exits shall be self-closing fire-resistive door assemblies as specified in s. Comm 51.047.

(2) **CLOSING DEVICE.** Doors protecting such openings shall be equipped with a closing device and shall normally be kept closed, except the doors may be held open by a hold open device actuated by products of combustion other than heat. The closing device shall be arranged such that the activation of any of the following systems will initiate the self-closing action of all such doors:

- (a) Manual fire alarm systems;
- (b) Automatic smoke detection systems;
- (c) Fire detection systems; or
- (d) Automatic sprinkler systems.

History: Cr. Register, December, 1981, No. 312, eff. 1-1-82; am. (2) (intro.), Register, December, 1983, No. 336, eff. 1-1-84.

Comm 58.61 Protection of vertical openings.

(1) Every elevator shaft, dumbwaiter shaft, laundry chute, waste-paper chute, pipe shaft, rubbish chute and other similar vertical shafts in buildings shall be enclosed with at least 2-hour fire-resistive construction as specified in s. Comm 51.043. All openings shall be protected with fire-resistive door assemblies as specified in s. Comm 51.047.

(2) (a) Vertical open shafts serving tiered multilevel residential housing areas shall be enclosed in accordance with s. Comm 51.02 (11), unless:

1. The entire normally occupied area, including all communicating floor levels, is sufficiently open and unobstructed so that it may be assumed that a fire or other dangerous condition in any part will be readily obvious to the occupants or supervisory personnel in the area;

2. Exit capacity is sufficient to provide simultaneously for all the occupants of all communicating levels and areas, with all communicating levels in the same fire area being considered as a single floor area for purposes of determination of required exit capacity; and

3. The height between the highest and lowest finished floor levels does not exceed 13 feet and the number of levels is not restricted.

History: Cr. Register, December, 1981, No. 312, eff. 1-1-82; am. Register, December, 1983, No. 336, eff. 1-1-84; 58.61 renum. to 58.61 (1), cr. (2), Register, March, 1991, No. 423, eff. 4-1-91.

Comm 58.63 Fire protection systems. (1) **SPRINKLER SYSTEMS.** Automatic fire sprinkler systems shall be provided as outlined in ss. Comm 52.01, 52.011, 52.012 and 52.013.

(2) **STANDPIPE SYSTEMS.** (a) *First-aid standpipes.* First-aid standpipes shall be provided as specified in s. Comm 51.21 for all detention and correctional facilities 60 feet or less in height, unless an approved automatic sprinkler system is installed.

(b) *Fire department standpipes.* Fire department standpipes shall be provided in all detention and correctional facilities exceeding 60 feet in height and shall comply with s. Comm 51.21.

(3) **FIRE EXTINGUISHERS.** Portable fire extinguishers shall be provided and maintained as specified in s. Comm 51.22.

Note: The department will accept placing portable fire extinguishers in a manner as indicated in s. Comm 58.64 (1) or (2) to minimize their potential for being used as weapons.

History: Cr. Register, December, 1981, No. 312, eff. 1-1-82; r. and recr., Register, March, 1991, No. 423, eff. 4-1-91; cr. (3), Register, January, 1994, No. 457, eff. 2-1-94.

Comm 58.64 Fire alarms. All detention and correctional facilities shall have a manually operated fire alarm system as specified in s. Comm 51.24, except as modified in this section.

(1) **MANUAL FIRE ALARM BOXES.** Manual fire alarm boxes may be locked, providing all staff carry the key which will unlock the fire alarm box.

(2) **LOCATION OF MANUAL FIRE ALARM BOXES.** Manual fire alarm boxes may be located at staff locations in lieu of being located at exits and stairways.

History: Cr. Register, December, 1981, No. 312, eff. 1-1-82.

Comm 58.65 Automatic smoke detection system.

(1) **LOCATION.** An approved automatic smoke detection system shall be installed in all sleeping rooms, holding rooms and in all corridors in connection with the sleeping room areas. Such systems shall be installed in accordance with NFPA 72 but in no case shall smoke detectors be spaced more than 30 feet apart on center or more than 15 feet from any wall, except as provided in sub. (2). All automatic smoke detection systems required by this section shall be electrically interconnected to the fire alarm system.

(2) **EXCEPTION.** Other arrangements and positioning of smoke detectors may be used to prevent damage or tampering or for other purposes provided the function of detecting any fire is fulfilled. This may include the location of detectors in exhaust ducts from sleeping rooms, behind grills, or in other locations.

Note: See s. Comm 52.015 for requirements pertaining to automatic fire sprinkler systems for detention and correctional facilities.

History: Cr. Register, December, 1981, No. 312, eff. 1-1-82; am. (1), Register, December, 1983, No. 336, eff. 1-1-84; am. (1), Register, February, 1999, No. 518, eff. 3-1-99.

Comm 58.66 Interior finishes. (1) WALLS AND CEILINGS. Interior finish of walls and ceilings in corridors, exits and any space not separated from exit access corridors and exits by a partition capable of retarding the passage of smoke shall be Class A. All other areas shall be Class A, B or C as defined in s. Comm 51.01 (75a).

(2) **FLOORS.** Interior floor finish in corridors and exits and any space not separated from exit access corridors and exits by a partition capable of retarding the passage of smoke shall be Class I as defined in s. Comm 51.01 (75a).

History: Cr. Register, December, 1981, No. 312, eff. 1-1-82.

Comm 58.67 Smoke barrier. (1) FIRE-RESISTIVE RATING. Smoke barriers shall have a one-hour fire-resistive rating as specified in s. Comm 51.04.

(2) **WHERE REQUIRED.** Smoke barriers are required to:

(a) Divide every story used by residents for sleeping, and any other story having an occupant load of 50 or more persons, into at least 2 compartments;

(b) Limit the housing of a maximum of 175 residents in any smoke compartment; and

(c) Limit on any story the length and width of each smoke compartment to no more than 150 feet.

(3) **AREA.** At least 6 square feet of accessible area per occupant shall be provided on each side of the smoke barrier for the total number of occupants in adjoining compartments.

(4) **DOORS.** (a) Openings in smoke barriers shall be protected by doors at least 36 inches wide, and such doors shall swing in the

direction of egress. Where egress may be in either direction, a pair of swinging doors shall be provided where each door swings in a direction opposite from the other, except doors in a means of egress may be of the horizontal sliding type providing the force to slide the door to its fully open position does not exceed 37 lbs.

(b) Doors in smoke barriers shall have at least a 20 minute fire-resistive rating, except that doors may be held open as specified in s. Comm 58.60.

(c) Louvers and grills in smoke barrier doors are prohibited. Doors may be undercut to a maximum of $\frac{3}{4}$ inches.

(d) A vision panel, complying with s. Comm 51.048 for wired glass and not exceeding 1,296 square inches and set in steel frames, shall be provided in each door in a smoke barrier.

(e) Rabbets, bevels, or astragals are required at the meeting edges of doors, and stops are required on the head and sides of door frames.

(5) **DAMPERS.** An approved damper designed to resist the passage of smoke shall be provided at each point a duct penetrates a smoke barrier. The damper shall close upon detection of smoke by an approved smoke detector, located within the duct except that:

(a) The approved damper, if located above a smoke barrier door, may be arranged to close upon detection of smoke by the local device designed to detect smoke on either side of the smoke barrier door opening; or

(b) Buildings designed with an engineered smoke control system as specified in NFPA 90A, Standard for the Installation of Air Conditioning and Ventilating Systems, need not comply with this requirement.

History: Cr. Register, December, 1981, No. 312, eff. 1-1-82; am. (4) (b), Register, December, 1983, No. 336, eff. 1-1-84.

Part 5 - Sanitary Facilities

Comm 58.68 Sanitary facilities. (1) TOILET ROOMS. Every building included under the scope of this subchapter shall be provided with separate toilet rooms for each sex, and shall comply with the requirements specified in this section and ss. Comm 52.52 to 52.62.

(a) **Exceptions.** 1. Enclosure of fixtures as specified in s. Comm 52.59 shall be required only for fixtures used by the staff or visitors, or both.

2. Water closet seats as specified in s. Comm 52.60 (1) are not required on water closets used by residents in maximum security detention and correctional facilities.

(2) **SANITARY FIXTURES.** (a) *Residents.* The number of sanitary fixtures required for each sex shall be determined in accordance with the ratios as specified in Table 58.68.

(b) *Employees.* The number of sanitary fixtures for employees shall be provided in accordance with the requirements as specified in Table 54.12-B and s. Comm 52.04.

(c) *General public.* The number of sanitary fixtures for the general public shall be provided in accordance with the requirements as specified in Table 54.12-A and s. Comm 52.04.

TABLE 58.68
NUMBER OF SANITARY FIXTURES REQUIRED
FOR RESIDENTS OF DETENTION AND
CORRECTIONAL FACILITIES ^{1,2}

Type of Fixture				
Water Closets (WC)		Urinals (U)	Lavatories (L)	Bathtubs or Showers ³
Males (M)	Females (F)	Males (M)		
One (WC) for each 8 (M) or fraction	One (WC) for each 8 (F) or fraction	Urinals may be substituted for up to 2/3 of the required number of (WC) for (M)	One (L) for each 8 persons or fraction	One for each 10 persons or fraction

¹ For structures with additions or alterations, the required number of sanitary fixtures shall be the sum of the fixtures required for the existing portion at the time it was constructed plus the fixtures required by this table for the new addition or altered area. At such time as the summation of the addition and alteration area is equal to or greater than 51% of the building area calculated as specified in s. Comm 50.03 (4) (d), fixtures shall be provided in conformance to this table utilizing the capacity of the entire building.

² Where a single toilet room designated as UNISEX is provided, it shall be considered as accommodating no more than 10 employees and 25 occupants.

³ In places of detention, the number of shower heads as specified in this table may be reduced provided a written statement is submitted to the department from the sheriff or jail administrator confirming that the shower facilities will be operated under scheduled shower times. In this case, the number of shower heads may be based on the number of occupants using the shower facilities at one scheduled time period. A minimum of 2 shower heads shall be provided.

History: Cr. Register, December, 1981, No. 312, eff. 1-1-82; r. and recr., Register, August, 1993, No. 452, eff. 3-1-94.

Part 6 – Guard Towers

Comm 58.69 Guard towers and observation stations. (1) **CLASS OF CONSTRUCTION.** (a) Except as provided in par. (b), guard towers shall be of type 1, 2 or 3 construction as specified in s. Comm 51.03.

(b) Guard towers classified as Type 3 construction may have a non-combustible roof assembly with no fire-resistive rating. A Class A roof covering is acceptable.

(2) **MEANS OF EGRESS.** At least one exit stairway shall be provided from a guard tower or observation station and shall be a minimum of 28 inches in width. Spiral stairways are permitted to serve guard towers and observation stations not greater than 150 net square feet. Spiral stairways shall comply with s. Comm 51.16 (7).

(3) **INTERIOR FINISH.** The interior finish of guard towers and observation stations shall be of Class A or B as defined in s. Comm 51.01 (75a).

(4) **HIGH HAZARD MATERIAL.** Storage of high hazard material is prohibited in the guard tower, observation station, or immediate

vicinity, except for weapons, ammunition, and control chemicals in quantities required for use by the staff occupying the tower or observation station.

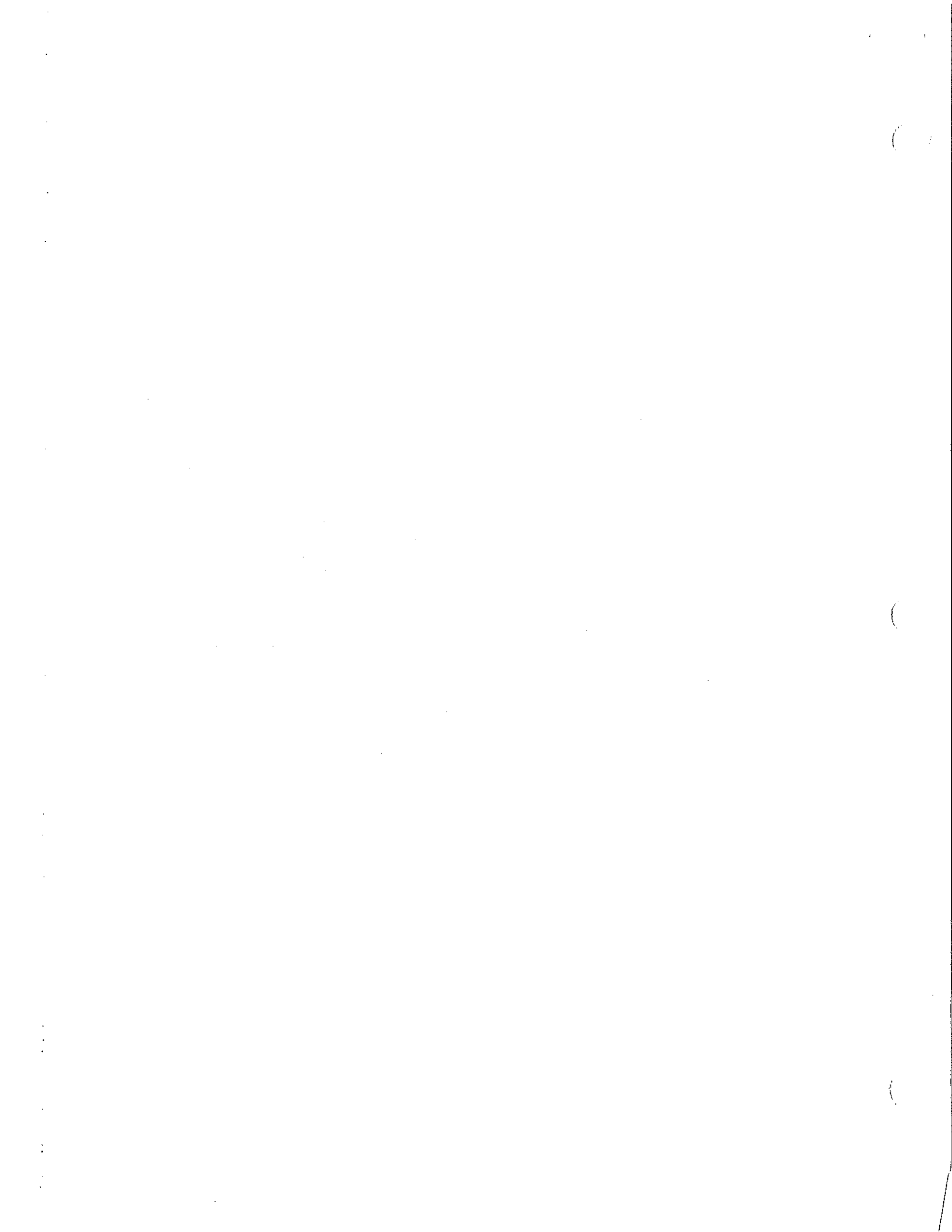
(5) **PROTECTION OF VERTICAL OPENINGS.** Every stairway, elevator shaft, dumbwaiter shaft, or other similar vertical openings shall be enclosed with at least 2-hour fire-resistive construction as specified in s. Comm 51.043, except guard towers and observation stations where there is no occupancy below the top floor level, stairs may be unenclosed.

(6) **SANITARY FACILITIES.** (a) Toilet facilities are not required in guard towers or observation stations provided toilet facilities are available in adjacent buildings to accommodate the number of occupants in the guard towers or observation stations.

(b) Toilet fixtures which are provided in single employe guard towers need not be enclosed as specified in ss. Comm 52.50 and 52.59.

(7) **DOOR LOCKS.** Doors to guard towers may be locked in accordance with s. Comm 58.59.

History: Cr. Register, December, 1981, No. 312, eff. 1-1-82; am. (2), Register, December, 1983, No. 336, eff. 1-1-84; am. (1), Register, August, 1983, No. 356, eff. 1-1-86; am. (6) (intro.), cr. (6) (b), Register, August, 1993, No. 452, eff. 3-1-94.



Chapter Comm 59

HAZARDOUS OCCUPANCIES

Comm 59.001	Scope.	Comm 59.16	Capacity of structures.
Comm 59.01	Definitions.	Comm 59.17	Enclosure of stairways and shafts.
Comm 59.10	Scope.	Comm 59.18	Vehicular guardrails.
Comm 59.11	Construction.	Comm 59.19	Illumination levels.
Comm 59.12	Height and area.	Comm 59.20	Sanitary facilities.
Comm 59.13	Types of exits.	Comm 59.22	Occupancy separations and hazard enclosures.
Comm 59.14	Number and location of exits.	Comm 59.23	Fire protection systems.
Comm 59.15	Required exit width.	Comm 59.24	Fire alarms.

Note: Chapter Ind 59 was renumbered chapter ILHR 59 effective January 1, 1984. Chapter ILHR 59 was renumbered to be chapter Comm 59 under s. 13.93 (2m) (b) 1., Stats., and corrections made under s. 13.93 (2m) (b) 7., Stats., Register, September, 1998, No. 513.

Comm 59.001 Scope. This chapter applies to all hazardous occupancies as indicated in the scope of each subchapter.

History: Cr. Register, December, 1981, No. 312, eff. 1-1-82.

Comm 59.01 Definitions. (1) "Combustible liquid" means a liquid as defined in s. Comm 10.01 (22).

(2) "Flammable liquid" means a liquid as defined in s. Comm 10.01 (37).

(3) "Motor vehicle" means any self-propelled device fueled by a flammable or combustible liquid used to transport people or goods.

(4) "Open parking structure" means a structure as defined in s. Comm 62.10.

(5) "Private garage" means a structure or a part of a structure, either attached to a one- or 2-family dwelling or unattached but serving the dwelling, housing one or more motor vehicles owned by the occupant of the dwelling and used only for personal or family service, not serving as a place of employment.

(6) "Repair garage" means a structure or any part of a structure in which one or more motor vehicles are primarily repaired or serviced.

(7) "Storage garage" means any structure or part of a structure in which one or more motor vehicles are stored or parked and which is not a repair garage, private garage or open parking structure.

History: Cr. Register, December, 1981, No. 312, eff. 1-1-82; corrections in (1) and (2) made under s. 13.93 (2m) (b) 7., Stats., Register, January, 1994, No. 457, eff. 2-1-94; corrections in (1) and (2) were made under s. 13.93 (2m) (b) 7., Stats., Register, March, 2000, No. 531.

Comm 59.10 Scope. (1) The requirements of this subchapter apply to storage garages and repair garages.

(2) This chapter does not apply to the following occupancies:

(a) Storage garages serving community-based residential facilities within the scope of ch. Comm 61;

Note: See s. Comm 61.10 (2).

(b) Areas of factories and plants used for the manufacture or assembly of motor vehicles or their components;

(c) Drive-in or drive-through facilities not used for the storage of motor vehicles including, but not limited to those of banks, restaurants, hospitals, car washes, film processing centers or other similar occupancies; and

(d) Attached storage garages 500 sq. ft. or less in area serving a residential occupancy as specified in ch. Comm 57.

History: Cr. Register, December, 1981, No. 312, eff. 1-1-82; am. (1) and (2) (d), Register, March, 1991, No. 423, eff. 4-1-91; am. (2) (intro.), Register, January, 1994, No. 457, eff. 2-1-94.

Comm 59.11 Construction. (1) FLOORS. (a) The floor areas accommodating motor vehicles shall be of earth, gravel or noncombustible, nonabsorbent materials.

(b) Service pits and other similar depressions in the floor of a storage or repair garage shall be ventilated in accordance with ch. Comm 64.

(2) CLEARANCE REQUIREMENTS. Headroom clearances shall be maintained in accordance with s. Comm 51.164.

(3) CANOPIES. Free standing canopies and their supports or other similar structures over fuel dispensing equipment, when located less than 10 feet from a property line, shall be constructed of noncombustible materials.

History: Cr. Register, December, 1981, No. 312, eff. 1-1-82; am. (1) (a), Register, October, 1982, No. 322, eff. 11-1-82.

Comm 59.12 Height and area. (1) STORAGE GARAGES. Storage garages shall not exceed the number of stories and corresponding area limitations of Table 59.12-1 or 59.12-2.

(2) REPAIR GARAGES. Repair garages shall not exceed the number of stories and 75% of the corresponding area limitations of Table 59.12-1 or 59.12-2.

(3) ALLOWABLE INCREASE OF FLOOR AREAS. (a) *Automatic fire sprinkler system protection.* 1. Chapter Comm 59 buildings not protected by automatic fire sprinkler systems may not exceed the height and area limitations specified in subs. (1) or (2) and Table 59.12-1.

2. a. Chapter Comm 59 buildings protected by complete automatic fire sprinkler systems may not exceed the height and area limitations specified in sub. (1) or (2) and Table 59.12-2.

b. The area of one story aircraft hangars of type No. 1 to 6 construction may be unlimited provided the building is completely protected by an automatic fire sprinkler system and the building is provided with street access around its entire perimeter.

(b) *Fire divisions.* No storage or repair garage shall be limited in area where divided into sections which do not exceed the maximum areas tabulated in this section by fire division walls as specified in s. Comm 51.02 (13). All openings in such walls shall be protected by swinging, sliding or overhead fire-resistant door assemblies as specified in s. Comm 51.047. Doors protecting such openings may be held open if equipped with rate of rise heat or photoelectric activated automatic closing devices. Doors used as required exits shall comply with the requirements of s. Comm 51.15.

History: Cr. Register, December, 1981, No. 312, eff. 1-1-82; correction in (3) (a) made under s. 13.93 (2m) (b) 7., Stats., cr. (4), Register, August, 1985, No. 356, eff. 1-1-86; emerg. r. table 59.12 and cr. tables 59.12-1 and 59.12-2, am. (1) and (2), r. and recr. (3) (a), eff. 9-6-86; r. table 59.12 and cr. table 59.12-1 and 59.12-2, am. (1) and (2), r. and recr. (3) (a), Register, November, 1986, No. 371, eff. 12-1-86; r. (4), am. tables, Register, January, 1994, No. 457, eff. 2-1-94.

TABLE 59.12-1
ALLOWABLE HEIGHT (STORIES) AND AREA (SQURE FEET) FOR BUILDINGS
WITHOUT COMPLETE AUTOMATIC FIRE SPRINKLER SYSTEM PROTECTION
(MAXIMUM GROSS FLOOR AREA PER FLOOR)

NOTE #1: DO NOT USE FOR BUILDINGS EXCEEDING 60 FEET IN HEIGHT

NOTE #2: FOR STORAGE GARAGES ONLY. USE 75% OF VALUES FOR REPAIR GARAGES

CLASS OF CONSTRUCTION	BUILDING FRONTAGE STREET* EXPOSURE	NUMBER OF STORIES									
		1	2	3	4	5	6	7	8	Over 8	
1. Fire-Resistive Type A	1	25,000	22,000	19,000	16,000	13,000	11,000	9,000	8,000	6,000	
	2	30,500	27,000	24,000	20,500	17,500	15,000	13,000	12,000	10,000	
	3	36,000	33,000	29,000	25,000	22,000	19,000	17,000	16,000	14,000	
	4	41,500	39,000	34,000	29,500	26,500	23,000	21,000	20,000	18,000	
2. Fire-Resistive Type B	1	23,000	20,000	17,000	14,000	11,000	9,000	7,000	6,000		
	2	28,500	25,000	22,000	18,500	15,500	13,000	11,000	10,000	N.P.	
	3	34,000	31,000	27,000	23,000	20,000	17,000	15,000	14,000		
	4	39,500	37,000	32,000	27,500	24,500	21,000	19,000	18,000		
3. Metal Frame Protected	1	21,000	18,000	15,000	12,000						
	2	26,500	23,000	19,500	16,000	N.P.	N.P.	N.P.	N.P.	N.P.	
	3	32,000	28,000	24,000	20,000						
	4	37,500	33,000	28,500	24,000						
4. Heavy Timber	1	17,000	14,000	11,000	9,000						
	2	22,000	19,000	16,000	13,500	N.P.	N.P.	N.P.	N.P.	N.P.	
	3	27,000	24,000	21,000	18,000						
	4	32,000	29,000	26,000	22,500						
5A. Exterior Masonry Protected	1	15,500	13,500	9,500	8,000						
	2	20,000	17,000	14,000	12,500	N.P.	N.P.	N.P.	N.P.	N.P.	
	3	24,500	21,500	18,500	15,500						
	4	29,000	26,000	23,000	19,500						
5B. Exterior Masonry Unprotected	1	14,000	11,500	9,000	7,000						
	2	18,000	15,000	12,500	10,000	N.P.	N.P.	N.P.	N.P.	N.P.	
	3	22,000	19,000	16,000	13,000						
	4	26,000	23,000	19,500	16,000						
6. Metal Frame Unprotected	1	14,000	11,500	9,000							
	2	18,000	15,000	12,500	N.P.	N.P.	N.P.	N.P.	N.P.	N.P.	
	3	22,000	19,000	16,000							
	4	26,000	23,000	19,500							
7. Wood Frame Protected	1	12,500									
	2	16,000	N.P.	N.P.	N.P.	N.P.	N.P.	N.P.	N.P.	N.P.	
	3	19,000									
	4	22,000									
8. Wood Frame Unprotected	1	10,000									
	2	12,000	N.P.	N.P.	N.P.	N.P.	N.P.	N.P.	N.P.	N.P.	
	3	14,000									
	4	16,000									

N.P. MEANS NOT PERMITTED

* Streets shall be within 50 feet of the adjacent building side with no obstructions between the street and the building that will impede fire fighting efforts. A 4-hour fire division wall may be considered as a street for the purpose of computing the area limitations for this table provided that no subdivided portion of the building has more streets than the entire building has.

TABLE 59.12-2
ALLOWABLE HEIGHT (STORIES) AND AREA (SQUARE FEET) FOR BUILDINGS
COMPLETELY PROTECTED BY AUTOMATIC FIRE SPRINKLER SYSTEM
(MAXIMUM GROSS FLOOR AREA PER FLOOR)

NOTE #1: USE FOR ALL BUILDINGS

NOTE #2: FOR STORAGE GARAGES ONLY. USE 75% OF VALUES FOR REPAIR GARAGES

CLASS OF CONSTRUCTION	BUILDING FRONTAGE STREET* EXPOSURE	NUMBER OF STORIES											
		1	2	3	4	5	6	7	8	9	Over 9		
1. Fire-resistive Type A One street required for unlimited area. See s. Comm 51.01 (124)	1												
	2												
	3				NO	LIMIT							
	4												
2. Fire-resistive Type B One street required for unlimited area. See s. Comm 51.01 (124)	1		69,000	60,000	51,000	42,000	33,000	27,000	21,000	18,000	N.P.		
	2	NO	85,500	75,000	66,000	55,500	46,500	39,000	33,000	30,000			
	3	LIMIT	102,000	93,000	81,000	69,000	60,000	51,000	45,000	42,000			
	4		118,500	111,000	96,000	82,500	73,500	63,000	57,000	54,000			
3. Metal frame protected	1	84,000	63,000	54,000	45,000	36,000	N.P.	N.P.	N.P.	N.P.	N.P.		
	2	106,000	79,500	69,000	58,500	48,000							
	3	128,000	96,000	84,000	72,000	60,000							
	4	150,000	112,500	99,000	85,500	72,000							
4. Heavy Timber	1	68,000	51,000	42,000	33,000	27,000	N.P.	N.P.	N.P.	N.P.	N.P.		
	2	88,000	66,000	57,000	48,000	40,500							
	3	108,000	81,000	72,000	63,000	54,000							
	4	128,000	96,000	87,000	78,000	67,500							
5A. Exterior Masonry Protected	1	62,000	46,500	40,500	28,500	24,000	N.P.	N.P.	N.P.	N.P.	N.P.		
	2	80,000	60,000	51,000	42,000	37,500							
	3	98,000	73,500	64,500	55,500	46,500							
	4	116,000	87,000	78,000	69,000	58,500							
5B. Exterior Masonry Unprotected	1	56,000	42,000	34,500	27,000	N.P.	N.P.	N.P.	N.P.	N.P.	N.P.		
	2	72,000	54,000	45,000	37,500								
	3	88,000	66,000	57,000	48,000								
	4	104,000	78,000	69,000	58,500								
6. Metal Frame Unprotected	1	56,000	42,000	34,500	27,000	N.P.	N.P.	N.P.	N.P.	N.P.	N.P.		
	2	72,000	54,000	45,000	37,500								
	3	88,000	66,000	57,000	48,000								
	4	104,000	78,000	69,000	58,500								
7. Wood Frame Protected	1	50,000	37,500	N.P.	N.P.	N.P.	N.P.	N.P.	N.P.	N.P.	N.P.		
	2	64,000	48,000										
	3	76,000	57,000										
	4	88,000	66,000										
8. Wood Frame Unprotected	1	40,000	30,000	N.P.	N.P.	N.P.	N.P.	N.P.	N.P.	N.P.	N.P.		
	2	48,000	36,000										
	3	56,000	42,000										
	4	64,000	48,000										

N.P. MEANS NOT PERMITTED

*Streets shall be within 50 feet of the adjacent building side with no obstructions between the street and the building that will impede fire fighting efforts. A 4-hour fire division wall may be considered as a street for the purpose of computing the area limitations for this table provided that no subdivided portion of the building has more streets than the entire building has.

Comm 59.13 Types of exits. (1) GENERAL. (a) Only the following types of exits shall be used to comply with the provisions of s. Comm 59.14:

1. Standard exit as specified in s. Comm 51.15, except as provided in sub. (2);

2. Stairways as specified in s. Comm 51.16, except as provided in sub. (2);

3. Smokeproof stair tower as specified in s. Comm 51.17;

4. Interior enclosed stairway as specified in s. Comm 51.18;

5. Horizontal exit as specified in s. Comm 51.19;

6. Fire escapes as specified in s. Comm 51.20; and

7. Nonparking access ramps with a maximum slope of 1:8.

(b) At least half of the exits required under s. Comm 59.14 shall be standard exits, stairways, smokeproof stair towers or interior enclosed stairways to grade.

(2) EXCEPTIONS. (a) A spiral stairway shall not serve as a required exit, but may be used as an employe convenience stairway if located in nonpublic areas.

(b) The width of required exit stairways serving unoccupied areas, such as storage areas, equipment mezzanines and similar areas not exceeding 750 sq. ft. may be reduced to 3 feet 0 inches.

(c) Doors in standard exits serving rooms, spaces or areas with an occupancy load of 25 persons or less are not required to swing in the direction of egress.

(d) A door not complying with s. Comm 51.15 (2), may be used as a standard exit serving storage garages or storage areas not exceeding 3,000 square feet in area.

Note: Where accessibility and interior circulation for persons with functional limitations must be provided, the requirements of s. Comm 52.04 (9) govern.

History: Cr. Register, December, 1981, No. 312, eff. 1-1-82; am. (2)(d), Register, August, 1985, No. 356, eff. 1-1-86.

Comm 59.14 Number and location of exits.

(1) GENERAL. (a) Every floor level and every room, space or area of a storage garage and a repair garage shall be provided with at least 2 exits.

(b) One exit is permitted in the following conditions:

1. Any room, space or area used for storage garage purposes with an occupancy load of 10 persons or less and which does not exceed 3,000 sq. ft. in net floor area;

2. Any room, space or area used for repair garage purposes and which does not exceed 750 sq. ft. in net floor area;

3. Any room, space or area used as other than a storage or repair garage with a capacity of 25 persons or less; and

4. A mezzanine floor level, provided the mezzanine is:

a. Three thousand square feet or less in net floor area;

b. Used only for storage purposes;

c. Open on at least one side to the floor below; and

d. Not more than 12 feet above the floor below.

(2) EXIT DISTANCE. Exits shall be provided and distributed as follows:

(a) *Storage garages.* 1. No area of a storage garage shall be more than 100 feet from an exit, unless the entire storage garage is protected by an automatic sprinkler system.

2. No area of a storage garage entirely protected by an automatic fire sprinkler system shall be more than 200 feet from an exit.

(b) *Repair garages.* 1. No area of a repair garage shall be more than 75 feet from an exit, unless the entire repair garage is protected by an automatic fire sprinkler system.

2. No area of a repair garage entirely protected by an automatic fire sprinkler system shall be more than 150 feet from an exit.

(c) *Measurement of exit distance.* The exit distances required by this section shall be measured along public passageways and aisles to:

Note: See Appendix A for further explanatory material.

1. Standard exits leading to grade as specified in s. Comm 51.15;

2. Doors opening into smokeproof stair towers as specified in s. Comm 51.17, interior enclosed stairways as specified in s. Comm 51.18, or fire escapes as specified in s. Comm 51.20; or

3. Horizontal exits as specified in s. Comm 51.19.

(3) LOCATION OF EXITS. Except as provided in sub. (1) (b), exits in all storage garages and repair garages shall be located and distributed so that in the event an exit is blocked, another exit is available from every area of the storage garage or repair garage.

(4) EXIT LIGHTS. All required exits shall be identified by an approved exit light. Directional exit lights shall be provided to direct occupants to the exits. Exit lights and directional exit lights shall be as specified in s. Comm 51.15 (5).

(5) EXIT MAINTENANCE. Exits shall be maintained in accordance with s. Comm 52.21.

History: Cr. Register, December, 1981, No. 312, eff. 1-1-82; cr. (4), Register, December, 1983, No. 336, eff. 1-1-84; emerg. am. (2) (a) 2. and (b), eff. 9-6-86; am. (2) (a) 2. and (b), Register, November, 1986, No. 371, eff. 12-1-86; am. (1) (a) and (b) (intro.), 2. and 3., Register, January, 1994, No. 457, eff. 2-1-94.

Comm 59.15 Required exit width. (1) GENERAL. Every floor level of a storage garage and repair garage shall be provided with at least the required aggregate width of exits as specified in ss. Comm 51.15 (6) and 51.16 (3).

(2) HORIZONTAL EXITS. Horizontal exits may provide up to one-half of the required aggregate width of exits for a floor level.

History: Cr. Register, December, 1981, No. 312, eff. 1-1-82.

Comm 59.16 Capacity of structures. In calculating the required aggregate width of exits under s. Comm 59.15 and the required number of sanitary facilities under s. Comm 59.20, the capacities of structures and floor levels shall be computed on the following basis:

(1) Storage garages and repair garages – 300 sq. ft. per person; and

(2) Other areas as dictated by the appropriate sections of chs. Comm 54 to 62.

Note: See ss. Comm 54.05, 55.06, 56.07 for additional requirements.

History: Cr. Register, December, 1981, No. 312, eff. 1-1-82.

Comm 59.17 Enclosure of stairways and shafts.

(1) TWO FLOOR LEVELS. (a) All stairways and vertical openings serving 2 floor levels shall be enclosed with smoke partitions, unless:

1. The stairway or opening serves an open storage mezzanine less than 3,000 square feet in area;

2. The opening is not a required means of egress and the opening is separated from any exit access corridor or exit stairway by at least smoke partitions as specified in par. (a); or

3. The two-connected floor levels:

a. Are each provided with 6 air changes of exhaust ventilation per hour;

b. Are provided with interconnected fire detectors in accordance with NFPA 72;

c. Do not have open flame equipment located in the lower level; and

d. Have only pneumatic power equipment available for use.

(b) Smoke partitions enclosing stairways or vertical openings shall be constructed of solid and rigid materials.

(c) Openings in smoke partitions shall be protected with doors equipped with automatic closing devices.

(2) THREE OR MORE FLOOR LEVELS. Stairways and shafts serving 3 or more floor levels shall be enclosed pursuant to s. Comm 51.18 with fire-resistive construction as specified in Table 51.03-A.

History: Cr. Register, December, 1981, No. 312, eff. 1-1-82; reprinted to correct error in (2), Register, February, 1982, No. 314; am. (2), Register, October, 1982, No. 322, eff. 11-1-82; r. and recr. (1), Register, March, 1991, No. 423, eff. 4-1-91; am. (1) (a) 3. a., Register, January, 1994, No. 457, eff. 2-1-94.

Comm 59.18 Vehicular guardrails. Vehicular guardrails shall be provided at all floor openings and at all differences in floor level elevations as follows:

(1) DRIVE LANES. Vehicular guardrails shall be installed at the end of drive lanes and shall be designed for a minimum horizontal live load of 1000 pounds per linear foot acting at 18 inches above the floor level; and

(2) **PARKING STALLS.** Vehicular guardrails shall be installed at the end of parking stalls and shall be designed for a minimum horizontal live load of 500 pounds per linear foot acting at 18 inches above the floor level.

History: Cr. Register, December, 1981, No. 312, eff. 1-1-82.

Comm 59.19 Illumination levels. (1) EXITS. All stairways and exits and the passageways leading to them shall be illuminated to facilitate egress. The intensity of illumination shall be not less than 10 footcandles at the floor or step level.

(2) **DRIVING AREAS.** The minimum illumination level for driving areas at a horizontal plane 30 inches above the floor shall be an intensity of at least 2 footcandles.

History: Cr. Register, December, 1981, No. 312, eff. 1-1-82.

Comm 59.20 Sanitary facilities. (1) GENERAL. Sanitary facilities shall be provided as specified in s. Comm 54.12, 55.32 or 56.16, as appropriate for the use of the building.

(2) **UNATTENDED STORAGE GARAGES.** Sanitary facilities are not required to be provided in unattended storage garages.

History: Cr. Register, December, 1981, No. 312, eff. 1-1-82.

Comm 59.22 Occupancy separations and hazard enclosures. Occupancies within the scope of this chapter shall be separated from other occupancies or uses in accordance with s. Comm 51.08. Hazards shall be enclosed in accordance with s. Comm 51.08.

History: Cr. Register, December, 1981, No. 312, eff. 1-1-82; am. table, Register, October, 1982, No. 322, eff. 11-1-82; am. table, Register, December, 1983, No. 336, eff. 1-1-84; r. and recr., Register, March, 1991, No. 423, eff. 4-1-91; r. and recr., Register, December, 1995, No. 480, eff. 4-1-96; r. and recr., Register, March, 1997, No. 495, eff. 4-1-97.

Comm 59.23 Fire protection systems. (1) SPRINKLER SYSTEMS. Automatic fire sprinkler systems shall be provided as outlined in ss. Comm 52.01, 52.011, 52.012 and 52.013.

(2) **STANDPIPES. (a)** Fire department standpipes shall be provided as follows:

1. In all storage garages and repair garages 3 or more stories in height; and

2. In all storage garage and repair garage floor levels more than 500 sq. ft. in area, located below grade and not accessible to fire fighting vehicles.

(b) Required fire department standpipes with a fire department siamese connection greater than 50 feet to a street shall be interconnected to a standpipe system with such a connection 50 feet or less to a street.

(c) Required fire department standpipes shall be provided in each stair enclosure serving a storage or repair garage and shall be provided with approved 2½ in. valve hose connections at each floor level with one connection in the stair tower and one immediately outside.

(d) Fire department standpipes shall conform to the requirements specified in s. Comm 51.21 (3) (e) to (i).

(e) 1. The department will recognize alternative systems and designs in lieu of required fire department standpipes, if an equivalent degree of safety is provided in storage or repair garages 60 feet or less in height.

2. The department will accept storage garages or repair garages without fire department standpipes, if clearances are provided to allow fire fighting vehicles access throughout the storage or repair garages.

3. Fire department standpipes as specified in this subsection need not be provided in buildings 60 feet or less in height completely protected by an automatic fire sprinkler system.

4. Fire department standpipes shall be provided in buildings more than 60 feet in height in accordance with s. Comm 51.21 (3).

(3) **FIRE EXTINGUISHERS.** Portable fire extinguishers shall be provided and maintained as specified in s. Comm 51.22.

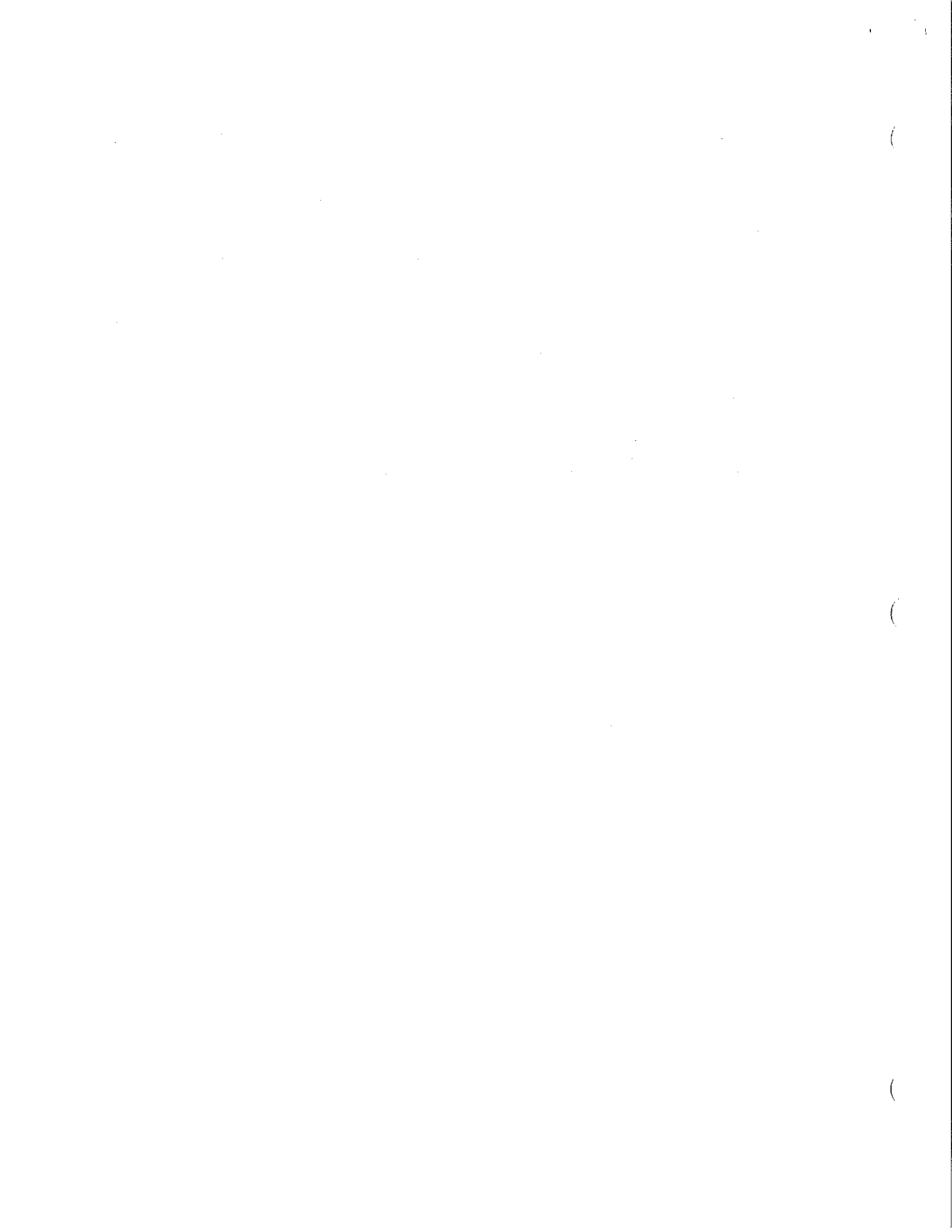
Note: See ch. Comm 52, subch. II for requirements pertaining to automatic fire sprinkler systems.

Note: See Appendix A for further explanatory material.

History: Cr. Register, December, 1981, No. 312, eff. 1-1-82; r. (2), renum. (3) to be (2), Register, June, 1983, No. 330, eff. 7-1-83; emerg. cr. (1) (e) 3. and 4., eff. 9-6-86; cr. (1) (e) 3. and 4., Register, November, 1986, No. 371, eff. 12-1-86; renum. and am. (1) to be (2), renum. (2) to be (3), cr. (1), Register, March, 1991, No. 423, eff. 4-1-91.

Comm 59.24 Fire alarms. A fire alarm system complying with s. Comm 51.24 shall be provided in every storage garage and repair garage where more than 10 persons are employed above the second story except storage garages and repair garages which are provided with a complete automatic sprinkler system.

History: Cr. Register, December, 1981, No. 312, eff. 1-1-82.



Chapter Comm 60

CHILD DAY CARE FACILITIES

Comm 60.001	Scope.
Comm 60.01	Definition.
Comm 60.10	Occupancy separations and hazard enclosures.
Comm 60.105	Height of first floor above grade.
Comm 60.11	Capacity of buildings.
Comm 60.12	Doors.
Comm 60.13	Windows and outside openings.
Comm 60.15	Sanitary facilities.
Comm 60.16	Electrical work.
Comm 60.17	Illumination.
Comm 60.18	Heating and ventilating.

Comm 60.19	Operating features.
Comm 60.30	Class of construction.
Comm 60.31	Exiting.
Comm 60.32	Required exit width.
Comm 60.33	Passageways.
Comm 60.34	Stair and shaft enclosure.
Comm 60.35	Fire protection systems.
Comm 60.36	Fire alarm and smoke detection systems.
Comm 60.38	Exit signs and emergency lighting.
Comm 60.39	Smoke compartments.
Comm 60.40	Smoke barriers.

Note: Chapter Ind 60 was renumbered chapter ILHR 60, effective in January 1, 1984. Chapter ILHR 60 was renumbered to be Chapter Comm 60 under s. 13.93 (2m) (b) 1., Stats., and corrections were made under s. 13.93 (2m) (b) 7., Stats., Register, September, 1998, No. 513.

Note: See ch. HFS 45 relating to day care licensing.

Comm 60.001 Scope. (1) (a) The requirements of this chapter shall apply to all buildings or parts of buildings which accommodate public or private day care centers for 4 or more children.

(b) The requirements of this chapter shall not apply to public school programs defined in s. 115.01 (1), Stats., or private school programs defined in s. 121.51 (3), Stats., or to short-time programs such as Boy Scouts, Girl Scouts, Sunday school and similar type programs.

Note: Refer to ch. HFS 45, rules of the department of health and family services for requirements pertaining to day care centers serving 4 to 8 children and HFS 46 for licensing requirements for group day care centers serving more than 9 children. Where more than one code applies, an owner must comply with the most restrictive requirements from the applicable codes.

(2) Chapters Comm 50 to 53 are applicable for general and structural design requirements. Chapters Comm 63 and 64 are applicable to newly constructed day care centers and to alterations to mechanical systems.

(3) School age day care programs for children 5 years of age and older shall comply with the requirements of one of the following chapters:

(a) Ch. Comm 56 – Schools and Other Places of Instruction; or

(b) Ch. Comm 60 – Child Day Care Facilities.

History: Cr. Register, October, 1974, No. 226, eff. 11-1-74; am. (4), Register, December, 1983, No. 336, eff. 1-1-84; cr. (5), Register, August, 1985, No. 356, eff. 9-1-85; emerg. r. and recr. eff. 9-1-89; r. and recr. Register, February, 1990, No. 410, eff. 3-1-90; am. (1) (a), Register, September, 2000, No. 537, eff. 10-1-00.

Comm 60.01 Definition. (1) “Day care center” means a facility required to be licensed under s. 48.65, Stats.

(2) “Floor level of exit discharge” means a first floor level of a building as specified in s. Comm 60.105 or a ground floor as defined in s. Comm 51.01 (67).

History: Cr. Register, October, 1974, No. 226, eff. 11-1-74; r. and recr. (1), Register, March, 1991, No. 423, eff. 4-1-91; r. and recr., Register, September, 1998, No. 513, eff. 10-1-98.

Comm 60.10 Occupancy separations and hazard enclosures. Occupancies within the scope of this chapter shall be separated from other occupancies or uses in accordance with s. Comm 51.08. Hazards shall be enclosed in accordance with s. Comm 51.08.

History: Cr. Register, October, 1974, No. 226, eff. 11-1-74; r. and recr., Register, December, 1981, No. 312, eff. 1-1-82; r. and recr., Register, March, 1991, No. 423, eff. 4-1-91; r. and recr., Register, December, 1995, No. 480, eff. 4-1-96; r. and recr., Register, March, 1997, No. 495, eff. 4-1-97.

Comm 60.105 Height of first floor above grade. The elevation of the first floor and the sills of all required exit

discharges from the first floor shall be at or not more than 6 feet above an exit discharge grade for existing buildings to be licensed as child day care centers.

History: Cr. Register, December, 1983, No. 336, eff. 1-1-84.

Comm 60.11 Capacity of buildings. The occupant load shall be the maximum number of children intended to occupy that floor, but not more than one child per 35 square feet of net floor area. Licensing requirements of the department of health and family services may supersede this requirement.

Note: The minimum staff-to-child ratio may be found under ch. HFS 46.

History: Cr. Register, October, 1974, No. 226, eff. 11-1-74; r. and recr., Register, September, 1998, No. 513, eff. 10-1-98.

Comm 60.12 Doors. (1) All exit doors, and all doors along the path of travel to an exit, shall meet the requirements of s. Comm 51.15 with the following exceptions:

(a) The width of all required exit doors may be reduced to 2 feet 8 inches in existing buildings not accommodating more than 8 children;

(b) All such doors used by not more than 25 persons need not swing outward;

(c) All such doors in centers serving 20 or less children need not be provided with illuminated exit signs; and

(d) Sliding glazed patio-type doors may serve as the second exit. A means to prevent accumulation of snow and ice in the door track or freezing of the door shall be provided.

(2) Every closet door latch shall be such that children can open the door from inside the closet.

(3) Every toilet room door lock shall be designed to permit opening of the locked door from the outside in an emergency, and the opening device shall be readily accessible to the staff.

History: Cr. Register, October, 1974, No. 226, eff. 11-1-74; cr. (1)(d), Register, December, 1977, No. 264, eff. 1-1-78; r. (1)(a), renum. (1)(b) to (d) to be (1)(a) to (c), Register, January, 1980, No. 289, eff. 2-1-80; am. (1) (c), Register, May, 1980, No. 293, eff. 6-1-80; cr. (1) (d), Register, December, 1981, No. 312, eff. 1-1-82.

Comm 60.13 Windows and outside openings.

(1) All areas used for sleeping purposes shall be provided with vision panels or windows facing directly upon a street, alley, or open court. The vision panels or windows shall be glazed with glass or other approved material.

(2) The windows or vision panels shall have a total glazed area of at least 8% of the floor area of the room served. The openable area of the windows shall be equal to at least 4% of the floor area of the room served.

(3) See s. Comm 60.18 (2) for exception to the requirement for openable windows.

History: Cr. Register, October, 1974, No. 226, eff. 11-1-74; am. (2) and (3), Register, January, 1980, No. 289, eff. 2-1-80; r. and recr. (2), Register, December, 1981, No. 312, eff. 1-1-82; am. (2), Register, October, 1982, No. 322, eff. 11-1-82; am. (1), Register, December, 1983, No. 336, eff. 1-1-84.

Comm 60.15 Sanitary facilities. (1) TOILET ROOMS. Toilet facilities consisting of at least one water closet shall be provided in all day care centers.

(2) SANITARY FIXTURES. (a) Number required for children.
 1. One water closet shall be provided for the first 10 children over the age of 30 months. One water closet shall be provided for each additional 15 children, or fraction, over the age of 30 months.

2. Children under the age of 30 months need not be included when determining the number of required water closets; however, in all cases at least one water closet shall be provided in each day care center.

3. Lavatories shall be provided in the ratio of one lavatory for every 2 water closets and urinals, or fraction.

Note: Section Comm 52.60 (2) (b) allows only stall type urinals in child day care facilities.

(b) Number required for staff members. 1. For day care centers with 10 or more staff members at one time, sanitary facilities, in accordance with Table 54.12-B, shall be provided in addition to those required for the children, as specified in par. (a).

2. Urinals may be substituted for up to 1/3 of the total required water closets for staff members.

(3) PRIVACY. Doors to the toilet rooms and water closet compartments may be omitted for toilet rooms used by children, provided that other toilet facilities equipped with toilet room doors and water closet compartment doors, are available for staff members and children 5 years of age and older.

(4) SEX DESIGNATION. Separate toilet rooms for each sex shall be provided and available for staff members in day care centers having 10 or more staff members at any one time.

Note: The term "staff member," as used in this section, is intended to include all employees, whether on pay status or on a volunteer status.

Note: The intent of sub. (3) is to allow toilet rooms used in common by both sexes in day care centers with less than 10 adults, and to omit the privacy requirements of toilet room doors and water closet compartment doors only for children who have not reached the age of sex awareness.

History: Cr. Register, October, 1974, No. 226, eff. 11-1-74; r. and recr. Register, December, 1976, No. 252, eff. 1-1-77; r. and recr., Register, December, 1977, No. 264, eff. 1-1-78; am. (1) (b) and (e), Register, August, 1985, No. 356, eff. 9-1-85; r. and recr., Register, August, 1993, No. 452, eff. 3-1-94.

Comm 60.16 Electrical work. (1) The electrical systems in existing buildings proposed to be used as day care centers shall conform to the Wisconsin state electrical code, volume 2, ch. Comm 16.

(2) Special protective receptacle covers shall be installed in all areas occupied by children.

History: Cr. Register, October, 1974, No. 226, eff. 11-1-74; correction in (1) made under s. 13.93 (2m) (b) 7., Stats., Register, December, 1996, No. 492.

Comm 60.17 Illumination. The illumination for occupied areas, other than sleeping areas, shall have a minimum intensity of 20 foot-candles at a horizontal plane 24 inches above the floor. All other spaces shall meet the requirements of s. Comm 73.04.

History: Cr. Register, October, 1974, No. 226, eff. 11-1-74; correction made under s. 13.93 (2m) (b) 7., Stats., Register, December, 1995, No. 480.

Comm 60.18 Heating and ventilating. (1) The heating system shall be capable of maintaining an inside temperature of not less than 67° F.

(2) Outside air at the rate of 7.5 cfm per person or as specified in s. Comm 64.05 shall be provided for centers that do not comply with the openable window requirements of s. Comm 60.13 (2).

Note: Section Comm 60.18 was revised in December, 1995, effective April 1, 1996. On April 6, 1996 the department of industry, labor and human relations published an emergency rule stating that the effective date of the December, 1995 rule revision was delayed. A permanent rule was adopted in December, 1996 stating that the revised text of s. Comm 60.18, as published, would be effective April 1, 1997.

History: Cr. Register, October, 1974, No. 226, eff. 11-1-74; am. (2), Register, January, 1980, No. 289, eff. 2-1-80; am. (2), Register, December, 1993, No. 480, eff. 4-1-96; am. (2), Register, December, 1996, No. 492, eff. 4-1-97.

Comm 60.19 Operating features. (1) Fire prevention inspections shall be conducted monthly. A copy of the latest completed inspection form shall be posted in a conspicuous place in the day care facility.

(2) A fire evacuation plan shall be practiced not less than once per month. Fire alarm and/or smoke detection systems shall be tested at weekly intervals. It is recommended that fire safety be a part of the educational program of the center.

(3) Furnishings, decorations, or other objects shall not be so placed as to obstruct exits, access thereto, egress therefrom, or visibility thereof.

(4) Flammable and combustible liquids shall be stored in areas accessible only to designated individuals and as recommended in NFPA standard No. 30, Flammable and Combustible Liquids Code.

Note: NFPA standard No. 30 is a mandatory standard for the storage of flammable and combustible liquids within the scope of ch. Comm 10.

Note: See Appendix A for further explanatory material.

(5) Guardrails protecting open sides of stairways, elevated platforms, walks, balconies and mezzanines shall have intermediate rails or an ornamental pattern designed to prevent the passage of a sphere with a diameter larger than 6 inches.

History: Cr. Register, October, 1974, No. 226, eff. 11-1-74; cr. (5), Register, January, 1980, No. 289, eff. 2-1-80; r. and recr. (5), Register, January, 1994, No. 457, eff. 2-1-94.

Comm 60.30 Class of construction. (1) GENERAL. Except as specified in sub. (2), the class of construction for day care centers shall comply with Table 60.30 and s. Comm. 51.03. Day care centers located in buildings of more than 4 stories shall be provided with one independent stairway serving the day care center only and shall be restricted to the height indicated in Table 60.30.

TABLE 60.30

Type of Construction	Maximum Allowable Height (feet)	Maximum Allowable Number of Stories			
		1	2	3	4
Fire-resistive Type A No. 1 and Type B No. 2	85	X	X	X	X
Metal Frame Protected No. 3 and Heavy Timber No. 4	75	X	X	X	
Exterior Masonry No. 5	50	X	(c)	(a) & (b) or (a) & (d)	
Metal Frame Unprotected No. 6	50	X	(c)	(a)	
Wood Frame Protected No. 7	40	X	X		
Wood Frame Unprotected No. 8	35	X	(c)		

X = permitted.

(a) All floors and supporting members shall have a one-hour fire-resistive rating.

(b) The entire building shall be equipped with an automatic sprinkler system in accordance with s. Comm 51.23.

(c) All ceilings shall be covered with 1/2-inch gypsum wall-board or equivalent.

(d) All floor systems shall be of noncombustible construction.

(2) DAY CARE CENTERS CARING FOR CHILDREN UNDER THE AGE OF 24 MONTHS. (a) Types No. 1 to No. 7 construction. The care of children under the age of 24 months shall be restricted to a floor level of exit discharge in a building of type No. 1 to No. 7, unless all of the following conditions are provided:

1. The entire building shall be completely protected by an automatic fire sprinkler system complying with s. Comm 51.23.

2. Each floor of the day care center where children under the age of 24 months are cared for shall be divided into at least 2 smoke compartments complying with s. Comm 60.39.

(b) *Type No. 8 construction.* The care of children under the age of 24 months shall be restricted to a floor level of exit discharge in buildings of type No. 8 construction.

History: Cr. Register, October, 1974, No. 226, eff. 11-1-74; am. (1), cr. (2), Register, September, 1998, No. 513, eff. 10-1-98.

Comm 60.31 Exiting. (1) Each floor shall have not less than 2 exits. All required exits shall lead directly, or through an enclosed stairway, to the outside.

(2) The exits shall be located to provide the best possible means of egress.

(3) Travel distance measured along safe passageways between:

(a) Any point in a sleeping room or suite and an exit access door of that room or suite shall not exceed 50 feet;

(b) Any room door intended as an exit access and an exit shall not exceed 50 feet; and

(c) Any point in a room or suite and an exit shall not exceed 100 feet.

(4) The travel distances in sub. (3) shall be reduced by 50% for children under the age of 24 months.

(5) The travel distances in sub. (3) may be increased by 50 feet in buildings completely protected with an automatic fire sprinkler system. No increase in travel distance is permitted for children under the age of 24 months.

History: Cr. Register, October, 1974, No. 226, eff. 11-1-74; am. (4), (5) and (6) Register, December, 1977, No. 264, eff. 1-1-78; am. (6), Register, December, 1983, No. 336, eff. 1-1-84; am. (4) and (5), Register, August, 1985, No. 356, eff. 9-1-85; r. (6), Register, September, 1998, No. 513, eff. 10-1-98.

Comm 60.32 Required exit width. (1) The total required exit width from a building level shall be in accordance with the requirements of ss. Comm 51.15 (6) and 51.16 (3).

(2) If horizontal exits (s. Comm 51.19) are provided for any floor, the number of persons accommodated on such floor may be increased at the rate of 100 persons for each 40 inches of width of such exits, provided such increase shall not exceed 100% of the number of persons accommodated by the stairways.

History: Cr. Register, October, 1974, No. 226, eff. 11-1-74; r. and recr. Register, December, 1974, No. 228, eff. 1-1-75.

Comm 60.33 Passageways. (1) The minimum unobstructed width of corridors and passageways shall be determined in the same manner as specified for stairways and exits in s. Comm 60.32. The minimum width shall be not less than 3 feet 8 inches.

(2) The minimum passageway width shall not be less than 3 feet in existing buildings proposed to be used as day care centers, provided the capacity of the day care center does not exceed 40 persons.

History: Cr. Register, October, 1974, No. 226, eff. 11-1-74; reprinted to restore dropped copy in (2), Register, October, 1998, No. 514.

Comm 60.34 Stair and shaft enclosure. (1) GENERAL. Except as provided in sub. (2), all stairs and vertical shafts serving 2 or more floor levels shall comply with the requirements of s. Comm 51.02 (11) and Table 51.03-A. All required stair enclosures shall lead to the outside without interruption.

(2) EXCEPTIONS. Unenclosed stairways may be used as required exits in all of the following:

(a) Day care centers located in one story places of worship, providing the care of children under the age of 24 months is restricted to a floor level of exit discharge.

(b) Day care centers located in one and two story schools constructed prior to January 1, 1982, providing the care of the children under the age of 24 months is restricted to a floor level of exit discharge.

(c) Day care centers accommodating up to 39 children, providing the care of children under the age of 24 months is restricted to a floor level of exit discharge. The unenclosed stairway shall meet all of the following:

1. The unenclosed stairway connects the floor of exit discharge with only one adjacent floor level.

2. The unenclosed stairway is separated at all other floor levels by fire-resistive rated construction as specified in Table 51.03-A.

History: Cr. Register, October, 1974, No. 226, eff. 11-1-74; am. (1), Register, October, 1982, No. 322, eff. 11-1-82; r. and recr. Register, August, 1985, No. 356, eff. 9-1-85; r. and recr. (2), Register, September, 1998, No. 513, eff. 10-1-98.

Comm 60.35 Fire protection systems. (1) SPRINKLER SYSTEMS. Automatic fire sprinkler systems shall be provided as outlined in s. Comm 52.012.

(2) FIRE EXTINGUISHERS. Portable fire extinguishers suitable for Class B fires shall be provided in kitchens or cooking areas in accordance with s. Comm 51.22.

TABLE 60.35

Basic Minimum Extinguisher Rating for Area Specified	Maximum Travel Distance to Extinguisher (feet)	Area to be Protected per Extinguisher (square feet)
2A	75	6,000
3A	75	9,000
4A	75	11,250
6A	75	11,250

Note: See Appendix A for further explanatory material.

History: Cr. Register, October, 1974, No. 226, eff. 11-1-74; r. and recr., Register, March, 1991, No. 423, eff. 4-1-91; am. (2), Register, January, 1994, No. 457, eff. 2-1-94.

Comm 60.36 Fire alarm and smoke detection systems. (1) SMOKE DETECTION SYSTEMS. (a) *Where required.* Except as specified in par. (b), in every building or portion of a building accommodating a day care center serving up to 20 children, stand-alone, battery-operated smoke detectors shall be installed in front of doors to the stairways and in the corridors of all floors occupied by the day care center. Smoke detectors shall also be installed in lounges, recreation areas and sleeping rooms in the day care center. The smoke detector alarm shall be audible throughout the day care center.

(b) *Exceptions.* Smoke detectors are not required in the following:

1. Day care centers housed only in one room.

2. A day care center serving children 6 years of age or older if no sleeping facilities are provided.

Note: See ch. Comm 69 for requirements on visual alarms.

(2) FIRE ALARM SYSTEMS. (a) *Where required.* Except as specified in par. (b), every building or portion of a building accommodating a day care center serving more than 20 children, a fire alarm system shall be installed that complies with s. Comm 51.24, or an approved smoke detection system shall be installed that complies with s. Comm 51.245.

(b) *Day care centers caring for children under the age of 24 months.* Where children under the age of 24 months are cared for on floors above or below a floor level of exit discharge, a fire alarm system shall be installed that complies with s. Comm 51.24, or an approved smoke detection system shall be installed that complies with s. Comm 51.245.

Note: See ch. Comm 69 and ADAAG 4.28 for requirements on visual alarms.

History: Cr. Register, October, 1974, No. 226, eff. 11-1-74; am., Register, December, 1981, No. 312, eff. 1-1-82; r. and recr. Register, January, 1994, No. 457, eff. 2-1-94; r. and recr., Register, September, 1998, No. 513, eff. 10-1-98; am. (1) (a), Register, September, 2000, No. 537, eff. 10-1-00.

Comm 60.38 Exit signs and emergency lighting.

(1) EXIT SIGNS. All required exit doors and exit passageways in a day care center serving more than 20 children shall be clearly marked with an illuminated exit sign as specified in s. Comm 51.15 (5).

Note: See ch. Comm 16 for requirements for standby emergency power for required exits.

(2) EMERGENCY LIGHTING. Standby emergency power of a type permitted by ch. Comm 16 shall be provided as a source of electrical power for emergency lighting for exit passageways

in a day care center where there are more than 20 children receiving nighttime care anytime between 9 p.m. and 5 a.m.

History: Cr. Register, October, 1974, No. 226, eff. 11-1-74; am. (1), Register, May, 1980, No. 293, eff. 6-1-80; am. (1), Register, December, 1983, No. 336, eff. 1-1-84; r. and recr. (2), Register, March, 1991, No. 423, eff. 4-1-91; r. and recr. Register, January, 1994, No. 457, eff. 2-1-94; corrections made under s. 13.93 (2m) (b) 7., Stats., Register, December, 1996, No. 492; r. and recr., Register, September, 1998, No. 513, eff. 10-1-98.

Comm 60.39 Smoke compartments. Smoke compartments as required by this chapter shall comply with the following:

(1) **DESIGN.** Smoke compartments shall be created by smoke barriers complying with s. Comm 60.40.

(2) **EXITING FROM COMPARTMENTS.** Each smoke compartment shall have access to at least 2 exits. At least one means of egress shall be an exit accessible immediately from each compartment. The second means of egress shall be permitted through adjacent compartments, but shall not require return through the compartment of fire origin.

History: Cr., Register, September, 1998, No. 513, eff. 10-1-98.

Comm 60.40 Smoke barriers. A smoke barrier required by this chapter shall be designed to restrict the movement of smoke between compartments and shall comply with the following:

(1) **GENERAL.** A smoke barrier shall form an effective continuous barrier from outside wall to outside wall and from floor slab to floor or roof deck above, including continuity through all concealed spaces, such as the space above suspended ceilings, and including interstitial structural and mechanical spaces.

(2) **RATING OF BARRIERS.** A smoke barrier shall have a fire-resistive rating of not less than 1 hour.

(3) **OPENINGS IN BARRIERS.** Openings in smoke barriers shall be protected as specified in ss. Comm 51.048 and 51.049. Door openings in smoke barriers shall be protected with fire doors with a rating of not less than 20 minutes.

(4) **PENETRATION OF BARRIERS.** (a) Except as specified in par. (b), penetrations in a smoke barrier shall comply with the requirements specified in s. Comm 51.049 and approved smoke dampers designed to resist the passage of smoke shall be provided at each point a duct or air transfer opening penetrates a smoke barrier wall. Approved combination smoke and fire dampers are permitted in lieu of a separate fire and smoke damper.

(b) Smoke dampers are not required where the building is provided with an engineered smoke control system.

(c) Structural framing may be continuous through or over the smoke barrier wall.

History: Cr., Register, September, 1998, No. 513, eff. 10-1-98; am. (3), Register, September, 2000, No. 537, eff. 10-1-00.

Chapter Comm 61

COMMUNITY-BASED RESIDENTIAL FACILITIES (CBRF) AND SHELTERED FACILITIES FOR BATTERED WOMEN

Comm 61.001 Scope.
Comm 61.01 Definitions.
Comm 61.10 Building construction and site.
Comm 61.11 Minimum class of construction.
Comm 61.12 Exiting and doors.
Comm 61.13 Sizes of rooms.
Comm 61.14 Smoke detection.
Comm 61.15 Windows.
Comm 61.16 Privacy.
Comm 61.17 Sanitary facilities.

Comm 61.18 Requirements for barrier-free environment.
Comm 61.19 Kitchen and cooking areas.
Comm 61.20 Fire extinguishers.
Comm 61.21 Maintenance and cleanliness.
Comm 61.215 Combustible and flammable liquids.
Comm 61.22 Building service equipment.
Comm 61.23 Potable water and plumbing.
Comm 61.24 Heating and ventilating.
Comm 61.25 Electrical.
Comm 61.26 Retroactivity.

Note: Chapter Ind 61 was renumbered chapter ILHR 61 effective January 1, 1984. Chapter ILHR 61 was renumbered to be chapter Comm 61 under s. 13.93 (2m) (b) 1., Stats., and corrections made under s. 13.93 (2m) (b) 7., Register, September, 1998, No. 513.

Comm 61.001 Scope. (1) CBRF SERVING 9-20. (a) The requirements of this chapter shall apply to all community-based residential facilities, herein afterwards referred to as CBRF, providing care, treatment and services to 9 through 20 unrelated adults, to be located in existing buildings.

Note: Refer to ch. HSS 82, rules of the department of health and family services for requirements pertaining to CBRF to be located in existing buildings providing care, treatment and services to 3 through 8 unrelated adults. Refer to ch. Comm 57 for CBRF requirements for buildings containing more than 20 unrelated adults.

(b) Except for s. Comm 51.01, the requirements of chs. Comm 51 to 53 and 64 do not apply to existing conditions unless specifically referred to in this chapter. Additions, alterations and remodelings shall conform to the current applicable portions of these chapters.

(2) NEWLY CONSTRUCTED CBRF. (a) All newly constructed CBRF providing care, treatment and services for 3 to 8 unrelated adults shall be within the scope of chs. Comm 20-25.

(b) All newly constructed CBRF providing care, treatment and services for 9 or more unrelated adults shall be within the scope of ch. Comm 57.

Note: This code is not intended to limit the power of cities, villages and towns to make, or enforce, additional or more stringent regulations, provided the regulations do not conflict with this code, or with any other rule of the department or law.

Note: CBRF intending to utilize federal funds may have to comply with other requirements in addition to those outlined herein, such as NFPA 101—Life Safety Code, ANSI standards for barrier-free design, and miscellaneous federal regulations.

(3) SHELTERED FACILITIES FOR BATTERED WOMEN. (a) The requirements of this chapter shall apply to all sheltered facilities for battered women, as specified in s. 46.95, Stats., serving 20 or less occupants.

(b) Except for s. Comm 51.01, the requirements of chs. Comm 51 to 53 and 64 do not apply to existing conditions unless specifically referred to in this chapter. Additions, alterations and remodelings shall conform to the current applicable portions of these chapters.

(4) SHELTERS FOR THE HOMELESS. The requirements of this chapter shall apply to shelter facilities serving 20 or less occupants.

Note: Refer to ch. Comm 57 for sheltered facilities serving more than 20 occupants.

History: Cr. Register, May, 1978, No. 269, eff. 7-1-78; am. Register, October, 1982, No. 322, eff. 11-1-82; correction in (2) (a) made under s. 13.93 (2m) (b) 7., Stats., Register, August, 1985, No. 356; cr. (4), Register, March, 1991, No. 423, eff. 4-1-91; correction in (2) (a) made under s. 13.93 (2m) (b) 7., Stats., Register, March, 2000, No. 531.

Comm 61.01 Definitions. (1) AMBULATORY. Ambulatory means able to walk without assistance or difficulty.

(2) CAPACITY. The capacity for CBRF is that maximum number of residents as allowed by rules of the department of health and social services.

(3) CLASSES OF CBRF. (a) *Class A.* Class A CBRF serve residents all of whom are ambulatory, capable of following directions and taking independent action for self-preservation under emergency conditions.

(b) *Class B.* Class B CBRF serve residents one or more of whom are semiambulatory or nonambulatory, but all of whom are mentally and physically capable of taking independent action for self-preservation under emergency conditions.

(c) *Class C.* Class C CBRF serve residents one or more of whom are not physically or mentally capable of taking independent action for self-preservation under emergency conditions.

(6) ELECTRICAL SERVICE. Electrical service means the conductors and equipment for delivering electrical energy from the supply system to and including the wiring system of the CBRF.

(7) EXISTING BUILDING. An existing building, for the purposes of this code (ch. Comm 61), is one which was constructed and occupied, or ready for occupancy, at least 24 months prior to the date of first application for licensure as a CBRF. Existing buildings which do not satisfy these requirements shall be considered new construction as specified in s. Comm 61.001 (2).

(7a) EXISTING BUILDING, CURRENTLY LICENSED. A facility licensed or certified within 24 months prior to the effective date of these rules (ch. Comm 61) is considered an existing building for the purposes of this code (ch. Comm 61).

(8) FLOORS AND STORIES. (a) *Attic floor.* Attic floor containing habitable rooms and that are occupied shall be counted as a story.

(b) *Basement floor.* A basement is a floor level partially or totally below grade and not having any required exit for any floor level above it.

(c) *First floor.* The first floor is the lowest floor having one or more required exits for that floor and for any floor above or below it.

(9) HABITABLE FLOOR SPACE. Habitable floor space is the area of habitable rooms with a ceiling height more than 5 feet 6 inches, used for the purposes of sleeping, living, cooking or dining.

(10) HABITABLE ROOM. A habitable room is any room used for the purposes of sleeping, living, cooking or dining, excluding such places as closets, bath or toilet rooms, pantries, stairways, corridors, service rooms, laundries, utility rooms, cellars or basements unless finished for occupancy, storage spaces, foyers, unfinished attics, administrative offices, garages and similar spaces.

(11) NONAMBULATORY. Nonambulatory means not able to walk at all.

(12) **OUTSIDE WINDOWS.** Outside windows are windows which open directly to the out-of-doors or to unheated enclosed spaces, such as exterior balconies or sun porches.

(13) **PRIMARY FUNCTION.** Primary function is the basic or essential care, treatment or service provided to residents of the facility.

(14) **SEMIAMBULATORY.** Semiambulatory means able to walk with difficulty or able to walk only with assistance of aids, such as crutches, canes or walkers.

History: Cr. Register, May, 1978, No. 269, eff. 7-1-78; r. (4) and (5), Register, March, 1991, No. 423, eff. 4-1-91.

Comm 61.10 Building construction and site.

(1) **CONDITION OF BUILDING AND SITE.** All buildings utilized as CBRF shall be structurally sound without visible evidence of structural failure or deterioration.

(a) All courts, yards, or other areas on the premises shall be properly drained or graded to divert water away from the building.

(b) Fences, other minor construction, driveways, parking areas and similar paved areas shall be properly maintained in a safe condition.

(c) Walks shall provide convenient all-weather access to buildings and shall be properly maintained in a safe condition.

(d) Exterior surfaces of buildings and structures not inherently resistant to deterioration shall be treated with a protective coating of paint or other suitable preservative which will provide adequate resistance to weathering. Any exterior surface treated with paint or other preservative shall be maintained so as to prevent chipping, cracking or other deterioration of the exterior surface or the surface treatment. All paint or other preservative shall be applied in a workmanlike fashion. Lead-based paint shall not be used.

(e) Every interior floor, wall and ceiling shall be kept in proper repair. Interior walls and ceiling in spaces subjected to moisture shall be provided with water-resistant, hard surfaces and shall have no serious surface irregularities or cracking.

Note: The use of "indoor-outdoor" carpeting, or other such carpeting approved for application on floors subjected to moisture, is acceptable.

(f) Every foundation wall, exterior wall, floor and roof shall be watertight, rodent-proof and reasonably weathertight, and shall be kept in proper repair.

(g) Every exterior window, exterior door and exterior basement hatchway shall be watertight, rodent-proof and reasonably weathertight and kept in proper repair. Every interior door shall be kept in proper repair. All installed door and window hardware shall be maintained in proper working condition.

(h) Every inside and outside stair, every porch and every appurtenance to the building shall be so maintained as to be safe in use.

(i) Abrasive strips or nonskid surfaces to reduce or prevent slipping shall be used when slippery surfaces present a hazard.

(2) **GARAGES AND ACCESSORY BUILDINGS.** Garages and accessory buildings located on the same property with a CBRF shall comply with the following:

(a) A CBRF shall be separated from an attached storage garage or repair garage in accordance with s. Comm 51.08.

(b) *Detached garages.* 1. Detached garages shall be located a minimum of 3 feet 0 inches from the CBRF.

2. Detached garages less than 3 feet 0 inches from the CBRF shall comply with the requirements for attached garages as found in sub. (2) (a).

(c) *Detached accessory buildings.* 1. Detached accessory buildings in which fueled, motorized vehicles and appliances (snowmobiles, power lawn mowers, motorcycles, snow blowers and similar equipment) are stored shall be located a minimum of 3 feet 0 inches from the CBRF.

2. Detached accessory buildings in which fueled, motorized vehicles and appliances are stored, less than 3 feet 0 inches from

the CBRF, shall comply with the requirements for attached garages as found in sub. (2) (a).

(3) **SMOKE SEPARATION.** (a) A door shall be provided at any interior stair between the basement and the first floor. This door shall be provided with a latch and an automatic closing device and normally be kept closed.

(b) Any shaft (clothes chute, dumbwaiter, laundry chute and similar shafts) leading to the basement shall be provided with a door on each level above the lowest floor. The door shall be provided with a latch and an automatic closing device and shall normally be kept closed.

Note: A spring of sufficient strength to close the door and activate the door latch will be acceptable for meeting the automatic closing device portion of these requirements.

History: Cr. Register, May, 1978, No. 269, eff. 7-1-78; r. and recr. (2) (a), Register, March, 1991, No. 423, eff. 4-1-91; am. (1) (f), Register, December, 1993, No. 456, eff. 1-1-94.

Comm 61.11 Minimum class of construction. Class of construction for CBRF shall comply with Table 61-I.

TABLE 61-I
MINIMUM CLASS OF CONSTRUCTION (s. Comm 51.03)

Number of Stories	Minimum Type of Construction for Class of CBRF		
	Class A	Class B	Class C
1	8	8	3(c),(d)
2	8	8(b),(c)	2(e)
3	5(a)	2(d)	2
4	5	2	2
5 to 8	2	2	2
Over 8	1	1	1

(a) Type 8 construction will be permitted if the basement is protected by a complete automatic sprinkler system or if all ceilings, including basements, are completely protected with 1/2-inch gypsum wallboard, or equivalent, and all stairway exits are interior stairs, one of which is completely enclosed, with at least one-hour rated construction, to a first-story outside exit.

(b) Type 8 construction will be permitted if building is protected by a complete automatic sprinkler system or if only ambulatory residents are permitted above the first story and in the basement.

(c) Types 5 and 6 construction will be permitted if of totally noncombustible construction.

(d) Type 8 construction will be permitted if building is protected by a complete automatic sprinkler system and provided only ambulatory residents are permitted above the first story and in the basement.

(e) Types 3, 5 and 6 construction will be permitted if of totally noncombustible construction and the building is protected by a complete automatic sprinkler system.

Note: The following brief descriptions of construction types are included as guidelines only. Designers and builders should refer to s. Comm 51.03 and Table 51.03-A for detailed descriptions and requirements for the various construction types.

Type 8 — Wood framed walls, floors, roofs and partitions, including wood framed exterior walls faced with masonry veneers (typical residential construction).

Type 6 — Metal framed walls and roofs with steel structural framing; sheet metal covered exterior walls and roof (typical pre-engineered metal building).

Type 5 — Exterior walls entirely of masonry (concrete block, brick, concrete, etc.); floor and roof systems of wood, steel or concrete; interior partitions are wood framed. (Buildings with wood floor and roof systems or with wood framed partitions are not considered noncombustible.)

Type 3 — Totally noncombustible building with floors, roof and structural framing protected with hourly rated fireproofing material. Types 2 and 1 — The same as Type 3 but with higher degrees for fireproofing.

History: Cr. Register, May, 1978, No. 269, eff. 7-1-78.

Comm 61.12 Exiting and doors. (1) **NUMBER, TYPE AND ACCESS TO EXITS.** (a) All CBRF, and each floor level having habitable rooms, shall have at least 2 means of exit which provide unobstructed travel to the outside at street or grade level.

1. Exception. A single exit will be permitted from basements or attics utilized for recreational, nonsleeping purposes only.

2. A wooden balcony or a flat roof, within 10 feet of grade, or an exterior wood stair may serve as one of the required exits from the second floor of a 2-story CBRF, except Class B and C CBRF with nonambulatory residents on the second floor.

(b) Exits shall be standard exits to grade (doors), stairways as specified in sub. (3), or fire escapes. (See exception under sub. (1) (a) 1.)

(c) No exit passageway shall be through a private room or bath/toilet room.

(d) Exit passageways and stairways to the outside exits shall be at least 3 feet wide, except existing secondary exit passageways, stairways and doors may be reduced to 2 feet 4 inches in width.

(e) The required width shall be maintained clear and unobstructed at all times.

(2) DOORS. (a) Outside exit doors and doors in exit access corridors shall be at least 2 feet 8 inches in width, except as provided in sub. (1) (d) for existing secondary exit doors.

(b) All doors shall have such fastenings or hardware that they can be opened from the inside with one hand without the use of a key.

(c) Closet doors shall be openable from the inside.

(d) All interior doors equipped with locks shall be designed to permit opening of the locked doors from either side in case of emergency.

(3) STAIRS: GENERAL. (a) *Treads and risers.* All required interior and exterior exit stairways shall have a minimum tread width (exclusive of nosing or projection) of 9 inches and a maximum riser height of 8 inches.

1. Exception. Stairs serving basements and attics without habitable rooms may have a minimum tread width (exclusive of nosing or projection) of 8 inches and a maximum riser height of 9 inches.

(b) *Handrails.* One or more handrails, at least 29 inches above the nose of the tread, shall be provided on all stairways. Handrails shall be provided on the open sides of stairways and platforms.

(c) *Winder stairs.* 1. Winders in stairways shall be provided with handrails on both sides, at least 29 inches above the nose of the tread.

2. Winders in stairways used as required exits shall have treads of at least 7 inches in width at a point one foot from the narrow end of the tread.

(d) *Spiral stairs.* Spiral stairs shall be prohibited for use as required exit stairs.

(4) STAIRS: ENCLOSURE. (a) Three-story CBRF shall have at least one stairway exit, enclosed with at least one-hour rated construction, leading to a first-story outside exit.

(b) CBRF, 4 or more stories in height, shall have all stairways enclosed with at least one-hour rated construction. All required exit stairways shall have such enclosures leading to a first-story outside exit.

Note: Buildings of Type 1 and 2 construction require 2-hour rated stair enclosures in accordance with s. Comm 51.03 (1) and (2).

(5) ILLUMINATION. All exit passageways and stairways shall be capable of being illuminated at all times.

History: Cr. Register, May, 1978, No. 269, eff. 7-1-78.

Comm 61.13 Sizes of rooms. (1) **HABITABLE FLOOR SPACE.** (a) Each sleeping room for ambulatory residents shall contain not less than 60 square feet of habitable floor space; and each sleeping room for semiambulatory or nonambulatory residents shall contain not less than 90 square feet of habitable floor space.

(b) In addition to the area required in sub. (1) (a), the CBRF shall provide habitable floor space, other than sleeping rooms, of not less than 60 square feet of area for each ambulatory resident

and of not less than 90 square feet in area for each semiambulatory or nonambulatory resident.

(c) All habitable rooms shall have an average ceiling height of not less than 7 feet 0 inches.

History: Cr. Register, May, 1978, No. 269, eff. 7-1-78.

Comm 61.14 Smoke detection. (1) **GENERAL.** All CBRF within the scope of this chapter shall be provided with an approved smoke detection system.

(2) **TYPE OF SYSTEM.** The smoke detection system specified in sub. (1) shall be at least a low voltage interconnected smoke detection system designed to protect the entire facility and capable of sounding an alarm throughout the facility or at a central location upon activation of any smoke detector.

(3) **SMOKE DETECTOR LOCATION.** At least one approved interconnected smoke detector shall be provided at the following locations:

(a) At the head of every open stairway;

(b) At the door leading to every enclosed stairway on each floor level;

(c) In every corridor, spaced not more than 30 feet apart and not further than 15 feet from any wall;

(d) In each common use room, including living rooms, dining rooms, family rooms, lounges and recreation rooms but not including kitchens; and

(e) In each sleeping room in which smoking is allowed.

(4) **APPLICABILITY.** The provisions of this section shall apply to all CBRF constructed on or after September 1, 1985, and to those CBRF previously constructed.

Note: See s. Comm 51.245 for additional requirements pertaining to smoke detectors.

History: Cr. Register, May, 1978, No. 269, eff. 7-1-78; r. and recr. Register, December, 1978, No. 276, eff. 1-1-79; am., Register, December, 1981, No. 312, eff. 1-1-82, except (2) eff. 1-1-83; r. and recr. Register, August, 1985, No. 356, eff. 9-1-85; correction in (4) made under s. 13.93 (2m) (b) 14., Stats., Register, January, 1994, No. 457.

Comm 61.15 Windows. (1) **MINIMUM SIZE.** Every living and sleeping room shall have outside windows with a total glazed area of at least 10% of the floor area of the room. The openable area of such windows shall be equal to not less than 5% of the floor area of the room served.

(2) **MINIMUM OPENING FOR SLEEPING ROOMS.** At least one window in each sleeping room shall be openable from the inside without the use of tools and shall provide a clear opening of not less than 16 inches in the least dimension.

(3) **STORM WINDOWS AND SCREENS.** All windows serving habitable rooms shall be provided with storm windows in winter and openable windows serving habitable rooms shall be provided with insect-proof screens in summer.

(a) *Exception.* Insulated windows need not be provided with storm windows.

History: Cr. Register, May, 1978, No. 269, eff. 7-1-78; am. (1), Register, January, 1994, No. 457, eff. 2-1-94.

Comm 61.16 Privacy. Privacy for sleeping rooms shall be provided by full-height partitions and rigid, swing-type room doors.

History: Cr. Register, May, 1978, No. 269, eff. 7-1-78.

Comm 61.17 Sanitary facilities. (1) **TOILET ROOMS.** (a) A CBRF shall be provided with at least 2 separate toilet rooms which are accessible from public areas, such as nonsleeping areas, during all hours of operation.

(b) Toilet rooms shall be provided with locks to ensure privacy.

(2) **SANITARY FIXTURES.** (a) *Minimum number provided.* A CBRF shall be provided with at least 2 water closets, 2 lavatories connected to hot and cold water and 2 bathtubs or showers connected to hot and cold water.

(b) *Determination of number provided.* The ratio of occupants to water closets and lavatories shall be not less than one water

closet and one lavatory for each 8 occupants, or fraction. The ratio of occupants to bathtubs and showers shall be not less than one bathtub or shower for each 10 occupants, or fraction.

(3) ACCESSIBILITY. Toilet rooms shall be so located that the maximum vertical travel distance between toilet rooms and sleeping rooms shall be not more than one floor level.

Note: Also refer to ch. HFS 83 — Community-Based Residential Facilities, for additional requirements.

History: Cr. Register, May, 1978, No. 269, eff. 7-1-78; r. and recr., Register, August, 1993, No. 452, eff. 3-1-94.

Comm 61.18 Requirements for barrier-free environment. (1) SCOPE. The requirements of this section are intended to ensure that all CBRF licensed for mentally retarded or physically disabled residents shall be accessible and usable by such residents.

(2) DEFINITIONS. (a) *Primary floor.* The primary floor is any floor level at least 50% of which is used for habitable floor space.

(3) REQUIREMENTS FOR ACCESSIBILITY. All CBRF shall comply with the requirements found in Table 61.18.

TABLE 61.18

Barrier-Free Requirements	Class of CBRF ¹		
	A	B	C
Ramped or grade-level entrance from street, alley or ancillary parking to a primary floor	Not required	Not required	Required
Stepped entrance to a primary floor within 2'0" of grade	Not required	Required ¹	Not permitted
All passageway doors on primary floor minimum 2'-8" wide	Not required	Not required ¹	Required
All passageway doors on primary floor minimum 2'-6" wide	Not required	Required ^{2,3}	Not permitted ³
Elevators, ramps or lifts to other floor levels	Not required	Required ²	Required ⁴
Interior access to all common-use areas	Not required	Required ⁴	Required
Interior access to at least one bathing and toilet facility	Not required	Required	Required
Grab bars for toilet and bath fixtures	Not required	Required ⁵	Required ⁵
Compliance with s. Comm 52.04 (8)	Not required	Required ⁶	Required ⁶

¹Ramped or grade-level entrance required if residents are not capable of negotiating stairs.

²2'-8" doors required if residents in wheelchairs are allowed.

³2'-6" sleeping room doors permitted for rooms used by ambulatory residents.

⁴May be omitted if use of other floors is restricted to ambulatory or semiambulatory residents physically capable of negotiating stairs or if there are no one-of-a-kind, common-use areas located on those floors.

⁵Not required in rooms used only by ambulatory residents.

⁶Not required in rooms used only by ambulatory residents or residents not confined to a wheelchair.

(4) RAMP REQUIREMENTS. Ramps, as required in Table 61.18, shall comply with the following:

(a) *Ramp slope.* Ramps shall have a slope of not more than one foot of rise in 12 feet of run. An interior ramp with a slope of one foot of rise in 8 feet will be permitted. The ramps shall have a slip-resistant surface and shall have no side slope;

(b) *Ramp width.* Ramps shall be at least 4 feet wide, of which not more than 4 inches on each side may be occupied by a handrail;

(c) *Ramp handrails.* Ramps shall have a handrail on each side which shall be at least 2 feet 6 inches high (preferable height, 2 feet 8 inches). Handrails on unenclosed ramps shall include an intermediate parallel rail at mid height;

(d) *Ramp clearance.* Where ramps are provided to doorways, the ramp on each side of the doorway shall be level for a distance of 5 feet from the door; and

(e) *Ramp platforms.* Ramps having a 1:8 slope shall have a 5-foot long level platform at 16-foot intervals. Ramps having a 1:12 slope shall have a level platform at 30-foot intervals. Both types of ramps shall have a level platform at least 5 feet long where they turn and at least 5 feet of level clearance at the bottom of the ramps.

History: Cr. Register, May, 1978, No. 269, eff. 7-1-78.

Comm 61.19 Kitchen and cooking areas. All CBRF shall have a kitchen or an area set aside for cooking and dining accessible from public (non-sleeping) areas. Kitchens or cooking areas shall be provided with one sink, in good working condition, connected to hot and cold water; utility service connections; and space for a stove and a refrigerator.

History: Cr. Register, May, 1978, No. 269, eff. 7-1-78.

Comm 61.20 Fire extinguishers. A portable, dry chemical fire extinguisher, with a minimum 2A, 10 B-C rating, shall be provided on each occupied floor level. On the floor containing the

kitchen, the fire extinguisher shall be located in the kitchen or cooking area.

History: Cr. Register, May, 1978, No. 269, eff. 7-1-78; am. Register, August, 1985, No. 356, eff. 9-1-85.

Comm 61.21 Maintenance and cleanliness. All CBRF, and all parts thereof, shall be maintained and kept in good repair, shall be kept clean, and shall also be kept free from any accumulation of dirt, trash or debris.

History: Cr. Register, May, 1978, No. 269, eff. 7-1-78.

Comm 61.215 Combustible and flammable liquids. Combustible and flammable liquids shall be isolated in accordance with ch. Comm 10.

History: Cr. Register, March, 1991, No. 423, eff. 4-1-91; correction made under s. 13.93 (2m) (b) 7., Stats., Register, March, 2000, No. 531.

Comm 61.22 Building service equipment. Each gas line providing service piping connections for appliances shall have a separate shut-off (stop cock) for each appliance served.

History: Cr. Register, May, 1978, No. 269, eff. 7-1-78.

Comm 61.23 Potable water and plumbing. Where a public water supply is available it shall be used to provide a continuing and adequate supply of potable water. When a public water system is not available the well, or wells, shall be approved by the department of natural resources. Water samples from an approved well shall be tested at the state laboratory of hygiene, or a state approved laboratory, at least annually. The water supply shall be bacteriologically safe prior to use.

Note: Refer to ch. Comm 82 for requirements pertaining to the plumbing system.
History: Cr. Register, May, 1978, No. 269, eff. 7-1-78.

Comm 61.24 Heating and ventilating. (1) HEATING. (a) *General.* All occupied rooms in CBRF shall be provided with a permanently connected heating system.

(b) *Operation and maintenance.* 1. The heating system shall be maintained in a clean and safe condition. A minimum tempera-

ture, as specified in the licensing rules, shall be maintained in all CBRF.

2. Replacement equipment shall be of an approved type.

Note: The department recognizes listings of independent testing agencies such as American Gas Association (AGA) and Underwriters' Laboratories (UL).

(c) *Chimneys and breeching.* 1. Chimneys (masonry or factory-built) and breeching shall be kept in good repair and shall be of the type required for the type of connected heating equipment.

2. Every chimney shall be provided with an access panel to permit inspection and servicing.

(d) *Clearance to combustibles and combustible construction.*

1. Heating equipment shall be installed in accordance with the manufacturer's recommendations to provide minimum clearance. In the absence of manufacturer's recommendations, a minimum clearance of 36 inches shall be provided.

a. Exception: Existing installations providing less than 36 inches of clearance will be accepted if there is no physical evidence of problem (charring, etc.).

2. New combustible construction, such as partitions, shelving or storage lockers, shall not encroach upon the required clearance.

(e) *Safety features.* 1. All oil- and gas-fired equipment shall be provided with automatic controls that will shut off the fuel supply to the burner in case of ignition failure.

2. Fixed electric heating equipment shall be of a type equipped with safety and temperature controls.

3. Gas-fired fireplaces shall be provided with automatic controls that will shut off the fuel supply in case of flame-out and shall be properly vented.

4. Solid-fuel fireplaces shall be equipped with safety screen.

(f) *Space heaters.* Portable and fixed fuel-fired, and portable electric space heaters are prohibited in CBRF.

1. 'Exception'. Fixed, gas-fired pre-vented wall heaters may be used.

(2) **VENTILATION: GENERAL REQUIREMENTS.** (a) *Kitchen or cooking areas.* Kitchens or cooking areas shall be provided with at least one openable outside window, an exhaust fan vented to the outside, or a means of filtered mechanical air circulation.

(b) *Bath and toilet rooms.* Bath and toilet rooms shall have at least one openable outside window at least 2 square feet in area, or a mechanical or gravity exhaust vented to the outside, or an approved ductless exhaust fan.

History: Cr. Register, May, 1978, No. 269, eff. 7-1-78; r. (1)(e) 2. and 3., renum. (1)(e) 4. to 6. to 2. to 4., Register, March, 1991, No. 423, eff. 4-1-91.

Comm 61.25 Electrical. (1) GENERAL. (a) Every CBRF shall be supplied with electrical service, wiring, outlets and fixtures which shall be properly installed and shall be maintained in good and safe working condition.

(b) The electrical service shall be of the proper size to handle the load connected to it.

Note: As a guide to the owner/operator for determining the adequacy of existing electrical service, the habitable rooms should have electrical service capable of providing at least 3 watts per square foot of total floor area in addition to that provided for air conditioning, ranges, fixed electric heaters and motor-driven equipment 1/8hp or over.

(2) **PROTECTION.** The branch circuits shall be protected by S-type or equivalent safety type, tamper-proof fuses, or circuit breakers not to exceed the ampacity of the smallest wire size in the circuit.

(3) **MINIMUM NUMBER OF FIXTURES AND OUTLETS.** The minimum number of fixtures and outlets shall be as follows:

(a) Every lavatory, bathroom, kitchen or kitchenette, dining room, laundry room, and furnace room shall contain at least one approved ceiling or wall-type electric light fixture equipped with sufficient lamps or tubes to provide no less than 5 footcandles at the floor level at the center of room. A switched outlet may be substituted for a ceiling or wall fixture in dining rooms.; and

(b) Electric duplex outlet receptacles shall be provided as follows. (To determine room area, measurements shall be taken at room perimeter and shall include doors and door-alcoves.)

1. Living room, one per 75 sq. ft. of floor area or major fraction (minimum of 2).

2. Dining room, one per 75 sq. ft. of floor area or major fraction (minimum of 2).

3. Kitchen, one per 8 lineal feet or fraction of countertop and preparation area, including island-type areas. In addition, kitchens used for dining purposes, one per 75 sq. ft. of floor area or major fraction. Separate outlets shall be provided for refrigerators.

Note: Preparation areas include countertops and all other similar areas at counter height.

4. Bedroom, one per 75 sq. ft. of floor area or major fraction (minimum of 2).

5. Laundry, one.

6. Toilet rooms, one (may be part of wall fixture if 72 inches or less from floor).

7. Other habitable rooms, minimum of 2.

(4) **OUTLET AND SWITCH LOCATIONS; EXPOSED WIRING.** (a) *Outlets.* Convenience outlets shall be located to discourage use of extension cords.

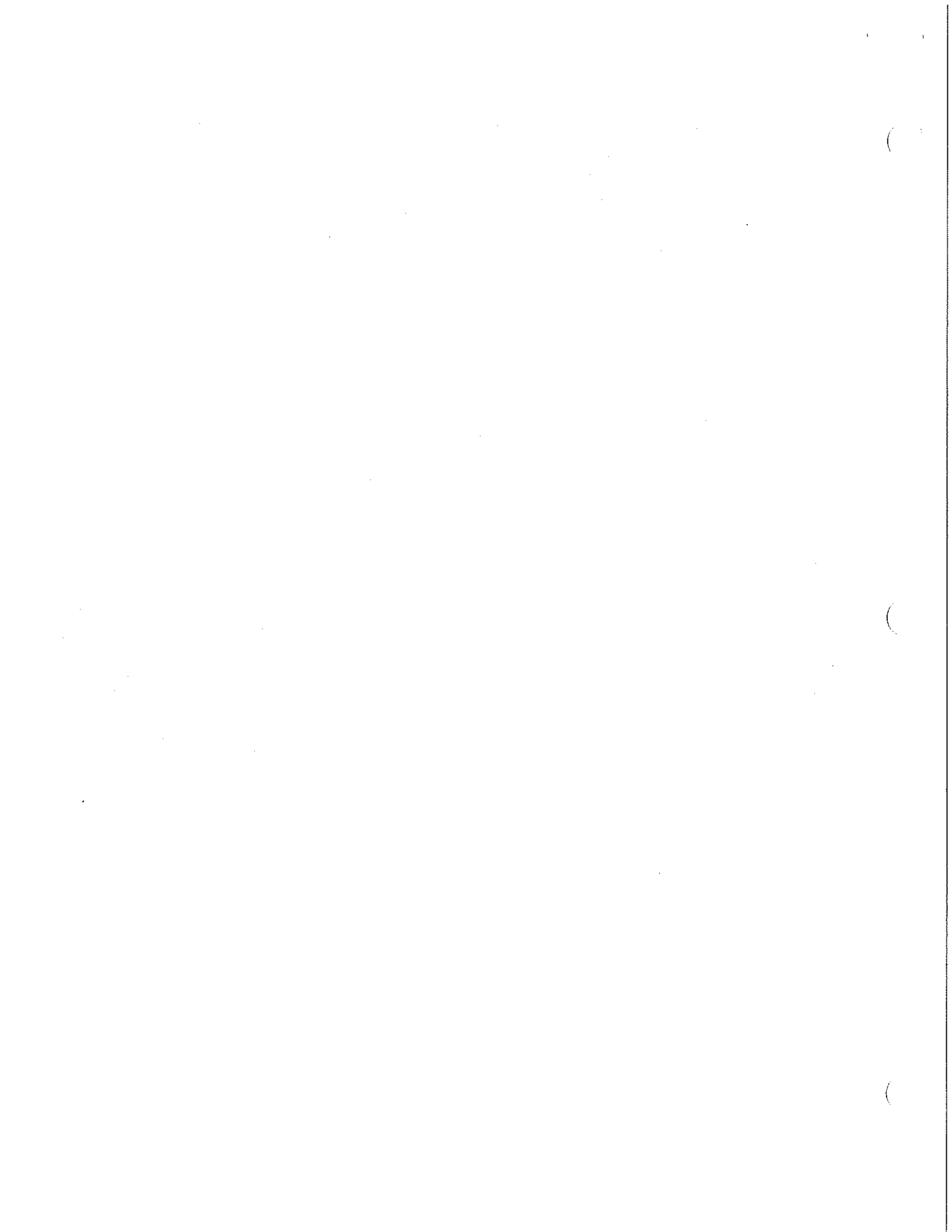
(b) *Switches.* Switches or equivalent devices for turning on one light in each room or passageway shall be located so as to conveniently control the lighting in the area.

(c) *Exposed wiring.* All temporary wiring and exposed, abandoned wiring shall be removed.

History: Cr. Register, May, 1978, No. 269, eff. 7-1-78; am. (3) (a), Register, March 1991, No. 423, eff. 4-1-91.

Comm 61.26 Retroactivity. The rules of this chapter shall apply to buildings with occupancies under the scope of this chapter now in existence and to buildings hereafter converted to use as a CBRF.

History: Cr. Register, May, 1978, No. 269, eff. 7-1-78.



Chapter Comm 62

SPECIALTY OCCUPANCIES

Comm 62.001 Scope.
Comm 62.10 Definitions.

Subchapter I — Open Parking Structures

Comm 62.20 Scope.
Comm 62.205 Classifications.
Comm 62.21 Construction requirements.
Comm 62.22 Setbacks.
Comm 62.23 Occupancy separations and hazard enclosures.
Comm 62.24 Construction, height and allowable area.
Comm 62.25 Clearance limitations.
Comm 62.26 Number, location and type of pedestrian exits.
Comm 62.27 Stairway enclosures.
Comm 62.28 Pedestrian and perimeter guardrails.
Comm 62.29 Illumination and exit lights.
Comm 62.30 Standpipes.
Comm 62.31 Sanitary facilities.
Comm 62.33 Exceptions for mechanical access open parking structures.
Comm 62.34 Barrier-free requirements.

Subchapter II — Television and Radio Transmitting and Receiving Antenna

Comm 62.35 Scope.
Comm 62.36 Construction requirements.
Comm 62.37 Design loads.
Comm 62.38 Antenna systems on buildings.
Comm 62.39 Setbacks.
Comm 62.40 Antenna system support.
Comm 62.41 Electrical requirements.

Subchapter III — Tents

Comm 62.42 Scope.
Comm 62.43 Area limitation and setbacks.
Comm 62.44 Structural requirements.
Comm 62.45 Flame resistance.
Comm 62.46 Fire hazards.
Comm 62.47 Exits.
Comm 62.48 Toilet facilities.
Comm 62.49 Electrical installations.
Comm 62.493 Fire extinguishers.
Comm 62.496 Illumination; exit lights and signs.

Subchapter IV — Membrane Structures

Comm 62.50 Scope.
Comm 62.501 Definitions.
Comm 62.502 Construction requirements.
Comm 62.503 Membrane requirements.
Comm 62.504 Exit requirements.
Comm 62.505 Equipment requirements.
Comm 62.506 Support provisions.

Comm 62.507 Standby power.
Comm 62.508 Engineering design.
Comm 62.509 Occupancy requirements.

Subchapter V — Outdoor Theaters

Comm 62.52 Scope.
Comm 62.53 Entrances and exits.
Comm 62.54 Vehicle storage.
Comm 62.55 Tower construction.
Comm 62.56 Location of tower.
Comm 62.57 Concession and motion picture machine booth.
Comm 62.58 Sanitary facilities.
Comm 62.59 Ramps and speaker equipment.
Comm 62.60 Lighting.
Comm 62.61 Speed limit.
Comm 62.62 Running of engines.

Subchapter VI — Assembly Seating Facilities

Comm 62.70 Scope.
Comm 62.71 Approval and supervision.
Comm 62.72 Inspection and maintenance.
Comm 62.73 Design loads.
Comm 62.74 Construction requirements.
Comm 62.75 Means of egress.
Comm 62.76 Seating.
Comm 62.77 Guardrails.
Comm 62.79 Sanitary facilities.
Comm 62.80 Illumination and emergency lighting.
Comm 62.81 Fire prevention.

Subchapter VII — Greenhouses

Comm 62.90 Scope.
Comm 62.91 Classifications.
Comm 62.92 Construction.
Comm 62.93 Hazard enclosures and separations.
Comm 62.94 Height and allowable area.
Comm 62.95 Exits.
Comm 62.96 Design loads.

Subchapter VIII — Pedestrian Access Structures Connecting Buildings

Comm 62.97 Scope.
Comm 62.98 General requirements.
Comm 62.99 Exiting.
Comm 62.991 Special requirements.

Subchapter IX — Amusement Facility & Specialty Event Centers

Comm 62.992 Specialty event centers.

Subchapter X — Mini-Storage Buildings

Comm 62.995 Mini-storage buildings.

Note: Chapter Ind 62 was renumbered chapter ILHR 62 effective January 1, 1984. Chapter ILHR 62 was renumbered to be chapter Comm 62 under s. 13.93 (2m) (b) 1., Stats., and corrections made under s. 13.93 (2m) (b) 7., Stats., Register, September, 1998, No. 513.

Comm 62.001 Scope. This classification includes all specialty occupancies as indicated in the scope of each subchapter of this chapter.

History: Cr. Register, December, 1977, No. 264, eff. 1-1-78; am. Register, December, 1981, No. 312, eff. 1-1-82.

Comm 62.10 Definitions. (1) "Assembly seating facilities" means structures including but not limited to, bleachers, grandstands and stadiums on which persons are seated for such purposes as entertainment, worship or deliberation.

(1m) "Greenhouses" means structures clad with light-transmitting material designed primarily for the purpose of cultivating plant life and used as public buildings or places of employment.

(2) "Open parking structure" means a structure with open areas in the exterior walls or ventilation shafts, or combination of both, as specified in s. Comm 62.21 used solely for the parking of passenger vehicles without any facilities for repairing or fueling of vehicles within the structure.

(3) "Outdoor theater" means a place of outdoor assembly used for the showing of plays, operas, motion pictures and similar forms of entertainment in which the audience views the performance from self-propelled vehicles parked within the theater enclosure.

(4) "Permanent" means in place for more than 180 consecutive calendar days.

(5) "Repair garage" means a structure as defined in s. Comm 59.01 (4).

(6) "Storage garage" means a structure as defined in s. Comm 59.01 (5).

(7) "Tents" mean portable, temporary shelters or structures, the covering of which is made of pliable material.

History: Cr. Register, December, 1977, No. 264, eff. 1-1-78; cr. (3) and (4), Register, January, 1980, No. 289, eff. 2-1-80; r. and rec., Register, December, 1981, No. 312, eff. 1-1-82; cr. (1m), Register, December, 1983, No. 336, eff. 1-1-84.

Subchapter I — Open Parking Structures

Comm 62.20 Scope. This subchapter provides the minimum requirements for the design and construction of open parking structures as specified in s. Comm 62.10 (2).

History: Cr. Register, December, 1977, No. 264, eff. 1-1-78; am., Register, December, 1981, No. 312, eff. 1-1-82.

Comm 62.205 Classifications. Open parking structures shall be classified as either ramp access or mechanical access types as follows:

(1) Ramp access, open parking structures employ a series of continually sloped floors or a series of interconnected ramps between floors permitting the movement of vehicles under their own power between the street level and parking areas; or

(2) Mechanical access, open parking structures employ fully automated parking machines, lifts, elevators or other mechanical devices for moving vehicles between the street level and the parking area, and in which public occupancy is prohibited above street level.

History: Cr. Register, December, 1981, No. 312, eff. 1-1-82.

Comm 62.21 Construction requirements. (1) GENERAL. Open parking structures shall be provided with open areas in the exterior walls or ventilation shafts, or a combination of both, on each level of at least 4% of the total floor area of that level, distributed on at least 2 exterior sides so as to provide cross ventilation.

(2) MATERIAL. All open parking structures shall be constructed of noncombustible materials.

Note: Structural components of open parking structures are subjected to corrosive and deteriorating elements. The designer should consider the effects of such elements and should consider the use of air-entrained concrete, concrete sealers and coatings, additional cover for reinforcing and other accepted engineering practices to protect the components.

(3) FLOORS. Floors shall be provided with drainage as specified in s. Comm 82.36.

History: Cr. Register, December, 1977, No. 264, eff. 1-1-78; r. and recr. Register, December, 1981, No. 312, eff. 1-1-82; correction in (3) made under s. 13.93 (2m) (b) 7., Stats., Register, August, 1985, No. 356; correction in (3) made under s. 13.93 (2m) (b) 7., Stats., Register, March, 1997, No. 495.

Comm 62.22 Setbacks. Open parking structures may be erected without enclosing walls, except that enclosing walls of not less than 2-hour fire-resistive construction, as specified in s. Comm 51.04, shall be provided on all sides which are less than 10 feet from a property line between premises or any other building.

History: Cr. Register, December, 1977, No. 264, eff. 1-1-78.

Comm 62.23 Occupancy separations and hazard enclosures. Occupancies within the scope of this chapter shall be separated from other occupancies or uses in accordance with s. Comm 51.08. Hazards shall be enclosed in accordance with s. Comm 51.08.

History: Cr. Register, December, 1977, No. 264, eff. 1-1-78; r. and recr. Register, March, 1991, No. 423, eff. 4-1-91; r. and recr., Register, December, 1995, No. 480, eff. 4-1-96; r. and recr., Register, March, 1997, No. 495, eff. 4-1-97.

Comm 62.24 Construction, height and allowable area. (1) CONSTRUCTION AND HEIGHT. Open parking structures shall be of the type of construction and shall not exceed the height as specified in this section. The maximum floor area of any such structure shall not exceed that permitted for the corresponding type of construction and height as follows:

(a) Open parking structures of noncombustible zero-hour (NC-0) rating shall not exceed 70 feet in height or 700,000 square feet in total area.

(b) Open parking structures of noncombustible 2-hour rating or better shall not be limited in height or area per floor level. Exterior walls need not be rated, except as provided in s. Comm 62.22.

Note: Open parking structures in excess of 60 feet in height are exempt from the administrative rules and statutes requiring automatic fire sprinkler systems (see s. Comm 52.01 (1) and (2) and s. 101.14, Stats.).

History: Cr. Register, December, 1977, No. 264, eff. 1-1-78; am. (1) (intro.), Register, December, 1981, No. 312, eff. 1-1-82.

Comm 62.25 Clearance limitations. (1) PRINCIPAL VEHICLE AND PEDESTRIAN TRAFFIC AREAS. The clear height of each floor level in principal vehicle and pedestrian traffic areas shall be not less than 7 feet 0 inches.

Note: See Appendix A for further explanatory material.

(2) CLEARANCE SIGNS. Clearance limitation signs shall be prominently posted at all vehicle entrances.

Note: A lesser clear height may be permitted in mechanical-access open parking structures when approved by the department.

History: Cr. Register, December, 1977, No. 264, eff. 1-1-78.

Comm 62.26 Number, location and type of pedestrian exits. (1) NUMBER OF EXITS. Every open parking structure and every floor level thereof shall have at least 2 exits.

(2) DISTANCE TO EXITS. Additional exits shall be provided so that no part of the open parking structure will be more than 200 feet distant to the exit discharge grade or to a stair enclosure if the walls separating the stair from the open parking structure are of at least noncombustible one-hour (NC-1) rating or better and the enclosure is continuous to an outside exit.

Note: In all cases, required exit stairs are required to be enclosed (see s. Comm 62.27). If the designer elects to increase the exit distance by measuring to the stair enclosure, the enclosure must have at least a noncombustible one-hour (NC-1) rating.

(3) LOCATION OF EXITS. Exits in all open parking structures shall be placed as far apart as practicable and so located that if any exit is blocked, some other exit will still be available from every part of the structure.

(4) TYPE OF EXITS. At least one-half of the exits required by this section shall be standard exits to grade, stairways or horizontal exits as specified in ss. Comm 51.15, 51.16 and 51.19, respectively. The other exits may be non-parking access ramps with a maximum slope of 1:8.

History: Cr. Register, December, 1977, No. 264, eff. 1-1-78; am. (4), Register, December, 1978, No. 276, eff. 1-1-79; am. (4), Register, January, 1980, No. 289, eff. 2-1-80.

Comm 62.27 Stairway enclosures. Stair enclosures of NC-0 hour rating, or better, shall be provided for all required exit stairways, unless otherwise required to be rated.

Note: It is the intent of s. Comm 62.27 to require all required exit stairs to be enclosed. If the designer elects to measure the exit distance to the stair enclosure, the enclosure must be then rated. (See s. Comm 62.26 (2).)

History: Cr. Register, December, 1977, No. 264, eff. 1-1-78.

Comm 62.28 Pedestrian and perimeter guardrails.

(1) PEDESTRIAN GUARDRAILS. (a) Pedestrian guardrails, or equivalent, conforming to the requirements of s. Comm 51.162, shall be provided on all open sides of the structure on each level.

(b) Pedestrian guardrails as specified in s. Comm 62.28 (1) (a) shall be provided at changes of elevation within the structure where the clear vertical opening at the elevation change is one foot 6 inches or greater.

(2) PERIMETER GUARDRAILS. (a) Perimeter guardrails shall be installed at the end of drive lanes and shall be designed for a minimum horizontal live load of 1000 pounds per lineal foot acting at 18 inches above the floor level.

(b) Perimeter guardrails shall be installed at the end of parking stalls and shall be designed for a minimum horizontal live load of 500 pounds per lineal foot acting at 18 inches above the floor.

History: Cr. Register, December, 1977, No. 264, eff. 1-1-78; am. (1), Register, January, 1980, No. 289, eff. 2-1-80.

Comm 62.29 Illumination and exit lights. (1) ILLUMINATION LEVELS. Minimum illumination levels at a horizontal plane 30 inches above the floor shall conform to the requirements of Table 62-I.

(2) **EXIT LIGHTS.** Every required exit from each floor shall be indicated by an approved exit sign as specified in s. Comm 51.15 (5).

TABLE 62-1
MINIMUM ILLUMINATION LEVELS

Area	Intensity (in foot-candles)
Stairways and exits	10
Parking areas	2

History: Cr. Register, December, 1977, No. 264, eff. 1-1-78; am. (2), Register, December, 1983, No. 336, eff. 1-1-84.

Comm 62.30 Standpipes. (1) FIRE DEPARTMENT STANDPIPES. Fire department standpipes shall be provided in all open parking structures 3 or more stories in height.

(a) Fire department standpipes shall be dry standpipes systems.

(b) Fire department standpipes with a fire department connection greater than 50 feet to a street shall be interconnected to a standpipe system with such a connection 50 feet or less to a street.

(c) Fire department standpipes shall be provided in each stair enclosure and shall be provided with approved 2½ inch valve hose connections at each floor level with one connection in the stair enclosure and one connection immediately outside the enclosure.

(d) Fire department standpipes shall be as specified in s. Comm 51.21 (3) (e) to (i).

(2) **EXCEPTIONS.** (a) The department will recognize alternative systems and designs if an equivalent degree of safety is provided in lieu of required fire department standpipes in open parking structures 60 feet or less in height.

(b) The department will accept open parking structures without fire department standpipes if clearances are provided to allow fire-fighting vehicles access throughout the open parking structure.

History: Cr. Register, December, 1977, No. 264, eff. 1-1-78; am. (1) (d) 2., Register, December, 1978, No. 276, eff. 1-1-79; r. and recr., Register, December, 1981, No. 312, eff. 1-1-82; am. (1) (intro.) and (c), Register, March, 1991, No. 423, eff. 4-1-91.

Comm 62.31 Sanitary facilities. (1) UNATTENDED PARKING STRUCTURES. Sanitary facilities need not be provided in unattended parking structures.

(2) **ATTENDED PARKING STRUCTURES.** Sanitary facilities for employees at attended parking structures shall be provided in accordance with s. Comm 54.12 (1) (a).

Note: Sanitary facilities for parking patrons need not be provided.

History: Cr. Register, December, 1977, No. 264, eff. 1-1-78; am. (2), Register, August, 1993, No. 452, eff. 3-1-94; correction in (2) made under s. 13.93 (2m) (b) 7., Stats., Register, March, 2000, No. 531.

Comm 62.33 Exceptions for mechanical access open parking structures. Mechanical access open parking structures need not comply with ss. Comm 62.25 to 62.29, inclusive.

History: Cr. Register, December, 1977, No. 264, eff. 1-1-78.

Comm 62.34 Barrier-free requirements. (1) PARKING SPACES. Accessible parking spaces shall be provided in accordance with the applicable requirements specified in s. Comm 52.04.

(2) **TOILET FACILITIES.** Toilet facilities provided for the employees, as specified in s. Comm 62.31 (2), shall comply with ch. Comm 69.

History: Cr. Register, December, 1978, No. 276, eff. 1-1-79; corrections in (1) and (2) made under s. 13.93 (2m) (b) 7., Stats., Register, March, 2000, No. 531; am. (2), Register, September, 2000, No. 537, eff. 10-1-00.

Subchapter II — Television and Radio Transmitting and Receiving Antenna

Comm 62.35 Scope. The requirements of this part shall apply to the outdoor portion of all apparatus, more than 12 feet in height, used for transmitting and receiving television or radio waves.

History: Cr. Register, December, 1978, No. 276, eff. 1-1-79.

Comm 62.36 Construction requirements. All television and radio antenna systems, including the supporting tower or mast, shall be constructed of galvanized steel or other corrosive-resistant noncombustible material. Where approved by the department, towers constructed of wood or wood poles set in the ground may be used to support antenna systems, but no wood tower or wood pole may be mounted on the roof of any building structure.

History: Cr. Register, December, 1978, No. 276, eff. 1-1-79.

Comm 62.37 Design loads. (1) DEAD AND ICE LOADS. The supporting tower shall be designed for the dead load of the structure and all appurtenances plus an ice load of at least ½ inch in radial thickness. The ice load shall be considered on all members of the structure including guys.

(2) **WIND LOADS.** (a) Self-supporting towers shall be designed for the wind loads specified in s. Comm 53.12.

1. Open face or latticed tower structures shall be designed for wind pressure applied to the projected area of all members, including ice, in one face multiplied by the following factors:

a. 1.75 for towers of square cross-section; or

b. 1.5 for towers of triangular cross-section.

2. Wind loads shall be considered basic design loads with no increase in allowable unit stresses permitted.

(b) Guyed towers shall be designed in accordance with a recognized engineering standard.

Note: "Structural Standards for Steel Antenna Towers and Antenna Supporting Structures", EIA Standard RS-222-C, published by Electronic Industries Association, 2001 Eye Street, N.W., Washington, D.C. 20006, is an acceptable standard for the design of guyed towers and self-supporting towers.

History: Cr. Register, December, 1978, No. 276, eff. 1-1-79; r. and recr. Register, December, 1983, No. 336, eff. 1-1-84.

Comm 62.38 Antenna systems on buildings. Antenna systems installed on the roof of a building shall not be supported by or attached to a chimney. All such installations shall be mounted on an independent platform or base and anchored in place. The platform or base of the tower shall be sized to distribute the weight of the structure so the roof construction will safely support the weight of the structure in addition to the required live and dead roof loads.

History: Cr. Register, December, 1978, No. 276, eff. 1-1-79.

Comm 62.39 Setbacks. No wires, cables, or guy wires shall extend over any street or other public thoroughfare or over any electric power or communication lines.

History: Cr. Register, December, 1978, No. 276, eff. 1-1-79; am. Register, December, 1983, No. 336, eff. 1-1-84.

Comm 62.40 Antenna system support. Poles or other structures used for electric power or for communication lines may not be used for supporting or for guying any antenna system, unless calculations are prepared, signed, and sealed or stamped by a Wisconsin registered architect or engineer that show the support system will support all live, dead, and special loads imposed upon it.

History: Cr. Register, December, 1978, No. 276, eff. 1-1-79; am. Register, March, 1991, No. 423, eff. 4-1-91; am. Register, September, 2000, No. 537, eff. 10-1-00.

Comm 62.41 Electrical requirements. Electrical installations in connection with antenna systems, including the grounding of the tower or mast, shall comply in all respects with

the requirements of the Wisconsin state electrical code, volume 2, ch. Comm 16.

History: Cr. Register, December, 1978, No. 276, eff. 1-1-79; correction made under s. 13.93 (2m) (b) 7., Stats., Register, December, 1996, No. 492.

Subchapter III — Tents

Comm 62.42 Scope. The requirements of this part shall apply to all tents, except those used exclusively for construction purposes.

History: Cr. Register, January, 1980, No. 289, eff. 2-1-80.

Comm 62.43 Area limitation and setbacks. (1) AREA OF GROUND COVERED. No tent shall be erected to cover more than 75% of the premises on which it is located.

(2) SETBACK TO PROPERTY LINE AND OTHER STRUCTURES. (a) Tents used for assembly purposes which cover 1500 square feet or more of ground area shall be located at least 20 feet from any other structure or adjoining property lines.

(b) Concession and other tents not used for assembly purposes need not be separated from each other and may be located less than 20 feet from other structures.

(3) SETBACK FOR EXITING. Stake lines of adjacent tents used for assembly purposes shall be sufficient distance from each other to provide an emergency exit passageway not less than 6 feet in width between stake lines. Proper protection shall be provided along such stake lines to eliminate tripping hazards.

History: Cr. Register, January, 1980, No. 289, eff. 2-1-80.

Comm 62.44 Structural requirements. (1) MATERIAL SIZE AND STRENGTH. Poles and other members supporting tents shall be of sufficient size and strength to support the structure safely without exceeding the stresses specified in ch. Comm 53.

(2) WIND LOAD. (a) All tents shall be adequately guyed, supported and braced to withstand a wind pressure or suction of not less than 10 pounds per square foot.

(b) The poles, guys, stakes, fastenings and similar devices shall be of sufficient strength and so attached as to resist a wind pressure of at least 20 pounds per square foot of projected area of the tent.

History: Cr. Register, January, 1980, No. 289, eff. 2-1-80.

Comm 62.45 Flame resistance. All tents used for assembly purposes or in which animals are stabled and all other tents used by the public in places of outdoor assembly shall be effectively flameproofed. The owner shall furnish a certificate or a test report by a recognized testing engineer or laboratory as evidence that such tents have the required flame resistance.

History: Cr. Register, January, 1980, No. 289, eff. 2-1-80.

Comm 62.46 Fire hazards. (1) CLEARING OF GROUND. The ground enclosed by a tent used in connection with a place of outdoor assembly and for a distance of not less than 10 feet outside such structure on all sides shall be cleared of all flammable material or vegetation which will transmit fire. The premises shall be kept free from such flammable material during the period the premises are used by the public.

(2) COMBUSTIBLE MATERIAL FOR CARE OF ANIMALS. No hay, straw, shavings or similar combustible materials other than that necessary for the current feeding and care of animals shall be permitted within any tents used for public assembly except that sawdust and shavings may be used if kept damp.

(3) NO SMOKING. No smoking or unapproved open flame of any kind shall be permitted in any tent while occupied by the public. "No Smoking" signs shall be conspicuously posted in all tents open to the public.

(4) SAFETY FILM. Tents shall not be used for motion picture performances unless safety film is used.

(5) COMBUSTIBLE AND FLAMMABLE LIQUIDS. Combustible and flammable liquids shall be isolated in accordance with ch. Comm 10.

History: Cr. Register, January, 1980, No. 289, eff. 2-1-80; cr. (5), Register, March, 1991, No. 423, eff. 4-1-91.

Comm 62.47 Exits. (1) NUMBER OF EXITS. (a) Every tent occupied by the public shall have at least 2 standard exits located at or near opposite ends of the structure.

(b) In tents used for assembly purposes, exits shall be provided on 3 sides if the capacity exceeds 600 persons and on 4 sides where the capacity exceeds 1,000 persons.

(2) EXIT DISTANCE. Exits shall be uniformly distributed but in no case shall the line of travel to an exit be greater than 150 feet.

(3) EXIT WIDTH. The total width of exits from a tent used for assembly purposes shall be not less than 44 inches per 100 persons. Exit openings shall comply in all respects with the requirements of ss. Comm 51.15 and 55.10.

History: Cr. Register, January, 1980, No. 289, eff. 2-1-80.

Comm 62.48 Toilet facilities. Separate toilet facilities, in conjunction with all tents used as places of outdoor assembly, shall be provided in accordance with s. Comm 55.32. Toilet rooms and equipment shall comply with the requirements of ss. Comm 52.50 to 52.64 or as approved by the department.

History: Cr. Register, January, 1980, No. 289, eff. 2-1-80.

Comm 62.49 Electrical installations. (1) GENERAL. Electrical systems in all tents used as places of outdoor assembly shall be installed in accordance with the requirements of the Wisconsin state electrical code, volume 2, ch. Comm 16. All such systems shall be maintained and operated in a safe and workmanlike manner.

(2) PROTECTION AND ISOLATION. The electrical system and equipment shall be isolated from the public by proper elevation and guarding. All electrical fuses and switches shall be installed in approved enclosures. Cables laid on the ground or in areas traversed by the public shall be placed in trenches or protected by approved covers.

History: Cr. Register, January, 1980, No. 289, eff. 2-1-80; correction in (1) made under s. 13.93 (2m) (b) 7., Stats., Register, December, 1996, No. 492.

Comm 62.493 Fire extinguishers. (1) GENERAL. Portable fire extinguishers shall be installed as specified in Table 62.493.

Note: See Appendix A for further explanatory material.

TABLE 62.493

Basic Minimum Extinguisher Rating	Maximum Travel Distance to Extinguisher (feet)	Area to be Protected per Extinguisher (sq. ft.)
1A	75	3,000
2A	75	6,000
3A	75	9,000
4A or larger	75	11,250

(2) LOCATION. (a) Extinguishers shall be conspicuously located where they will be readily accessible and immediately available in the event of fire.

(b) Extinguishers shall not be obstructed or obscured from view.

(3) MAINTENANCE. Portable fire extinguishers shall be maintained as specified in s. Comm 51.22.

History: Cr. Register, January, 1980, No. 289, eff. 2-1-80; r. and recr., Register, December, 1981, No. 312, eff. 1-1-82; renum. from Comm 62.50, Register, September, 2000, No. 537, eff. 10-1-00; correction in (1) made under s. 13.93 (2m) (b) 7., Stats., Register, September, 2000, No. 537.

Comm 62.496 Illumination; exit lights and signs. (1) LIGHTING OF EXITS. All exits, aisles and passageways leading to exits in tents used as places of outdoor assembly shall be kept adequately lighted at all times when the structure is occupied by the public. Artificial illumination having an intensity of not less

than 2.5 footcandles at the floor line shall be provided when natural light is inadequate.

(2) **ILLUMINATED EXIT SIGNS.** Exit lights and signs complying with the requirements of s. Comm 55.11 shall be provided in all tents used as places of outdoor assembly where more than 100 persons can be accommodated.

History: Cr. Register, January, 1980, No. 289, eff. 2-1-80; renum. from Comm 62.51, Register, September, 2000, No. 537, eff. 10-1-00.

Subchapter IV — Membrane Structures

Comm 62.50 Scope. (1) **GENERAL.** The provisions of this subchapter apply to air-inflated, air-supported, membrane-covered cable, and membrane-covered frame structures that are erected for a period of 180 days or longer, except as provided in sub. (2).

(2) **UNOCCUPIED.** A membrane structure that is not used for human occupancy, such as covering a water storage facility, water clarifier, water or sewage treatment plant, or greenhouse which is not used for retail or educational purposes, is only required to conform to ss. Comm 62.503 and 62.508.

History: Cr. Register, September, 2000, No. 537, eff. 10-1-00.

Comm 62.501 Definitions. In this subchapter:

(1) "Air-inflated structure" means a structure having a shape that is maintained by air pressurization of cells or tubes to form a barrel vault over the usable area. Occupants of such a structure do not occupy the pressurized area used to support the structure.

(2) "Air-supported structure" means a structure having a shape that is attained by elevated air pressure, and occupants of the structure are within the elevated pressure area.

(3) "Membrane" means a thin, flexible, impervious material capable of being supported by air pressure or structural frames or cables.

(4) "Membrane-covered structure" means a nonpressurized structure having a cable or rigid frame structural system that supports a membrane weather barrier.

History: Cr. Register, September, 2000, No. 537, eff. 10-1-00.

Comm 62.502 Construction requirements. (1) (a) A membrane structure shall be classified as Type 8 wood frame unprotected construction, except as specified in par. (b).

(b) A membrane structure may be classified as Type 6 metal frame unprotected construction if the structure and membrane are noncombustible materials as defined in s. Comm 51.01 (86).

(2) A membrane structure, regardless of occupancy, shall comply with the allowable floor area requirements in s. Comm 54.01.

(3) No membrane structure may exceed one story in height.

(4) Except as required by s. Comm 55.02 (2m), a membrane structure shall be at least 10 feet from a property line or another building, unless separated therefrom with a 4-hour fire division wall as specified in s. Comm 51.02 (13).

(5) A membrane structure may be used as specified in this subchapter as a portion of a building of another type of construction, provided the following requirements are met:

(a) Height and area limits shall be as specified for the type of construction and occupancy of the building.

(b) A membrane structure used as a roof or skylight shall be at least 20 feet above any floor, balcony or gallery.

(c) A flame-resistant membrane may not be used as a roof or skylight in Types 1 to 7 construction.

History: Cr. Register, September, 2000, No. 537, eff. 10-1-00.

Comm 62.503 Membrane requirements. (1) **GENERAL.** A membrane shall be either of the following, except as provided in sub. (2):

(a) Noncombustible as defined in s. Comm 51.01 (86).

(b) Flame-resistant as determined in accordance with both the small-scale and large-scale tests in NFPA 701, and with the manufacturer's test protocol.

(2) **UNOCCUPIED GREENHOUSE.** A membrane which has a thickness of less than 20 mils or which is less than 20 feet above the floor is not required to be flame resistant if used for an unoccupied greenhouse.

History: Cr. Register, September, 2000, No. 537, eff. 10-1-00.

Comm 62.504 Exit requirements. (1) **GENERAL.** All exits from a membrane structure shall comply with the requirements of s. Comm 51.15 to 51.20, except as provided in sub. (2) and s. Comm 62.509.

(2) **REVOLVING DOORS.** A membrane structure requiring the use of revolving doors for maintaining pressurization of the structure may utilize revolving doors for up to 50% of the required exit width if all of the following requirements are met:

(a) The leaves of a revolving door shall be capable of collapsing into a book-fold position.

(b) The two parallel egress paths formed in a revolving door when the leaves are in the book-fold position shall each have a width of at least 18 inches.

(c) A revolving door shall not be within 10 feet of the top or foot of stairs or escalators. Under all conditions, there shall be a dispersal area between the stairs or escalators and the revolving door.

(d) The revolutions per minute (RPM) of a revolving door shall not exceed the values specified in Table 62.504.

Table 62.504

Inside Diameter, feet	Power-Driven Type Speed Control, RPM	Manual-Type Speed Control, RPM
6.5	11	12
7	10	11
7.5	9	11
8	9	10
8.5	8	9
9	8	9
9.5	7	8
10	7	8

(e) Each wall containing a revolving door shall have a side-hinged swinging door that complies with this code, within 10 feet of the revolving door.

History: Cr. Register, September, 2000, No. 537, eff. 10-1-00.

Comm 62.505 Equipment requirements. (1) The inflation system shall consist of one or more blowers and shall include provisions for automatic control to maintain the required inflation pressures. The system shall be designed to prevent over-pressurization.

(2) (a) In addition to the primary inflation system, in buildings exceeding 1,500 square feet in area, an auxiliary inflation system shall be provided that has sufficient capacity to maintain the inflation of the structure in case of primary system failure. The auxiliary inflation system shall operate automatically if there is a loss of internal pressure or if the primary blower system becomes inoperative.

(b) Blower equipment shall meet the following requirements:

1. Blowers shall be powered by continuous-rated motors at the maximum power required for any flow condition as required by the structural design.

2. Blowers shall be provided with inlet screens, belt guards, and other protective devices to provide protection from injury.

3. Blowers shall be housed within a weather-protecting structure.

4. Blowers shall be equipped with back-draft check dampers to minimize air loss when inoperative.

5. Blower inlets shall be located to provide protection from air contamination. The location of inlets shall be approved by the department or its authorized representative prior to installation.

History: Cr. Register, September, 2000, No. 537, eff. 10-1-00.

Comm 62.506 Support provisions. A system capable of supporting the membrane in the event of deflation shall be provided for an air-inflated or air-supported structure having an occupant load of more than 50, or where covering a swimming pool regardless of occupant load. For a membrane structure used as a roof for a place of assembly of more than 100 persons, the support system shall be capable of maintaining the membrane at least 20 feet above the floor, seating area, or surface of the water. For all other membrane structures, the support system shall be capable of maintaining the membrane at least 7 feet above the floor, seating area, or surface of the water.

History: Cr. Register, September, 2000, No. 537, eff. 10-1-00.

Comm 62.507 Standby power. Whenever an auxiliary inflation system is required, an approved standby power-generating system shall be provided. The system shall be equipped with a suitable means for automatically starting the generator set upon failure of the normal electrical service and for automatic transfer and operation of all of the required electrical functions at full power within 60 seconds of such service failure. Standby power shall be capable of operating independently for a minimum of 4 hours.

History: Cr. Register, September, 2000, No. 537, eff. 10-1-00.

Comm 62.508 Engineering design. A membrane structure shall be structurally designed and constructed to sustain dead loads, loads due to tension or inflation, and live loads including wind and snow, and in accordance with ch. Comm 53.

History: Cr. Register, September, 2000, No. 537, eff. 10-1-00.

Comm 62.509 Occupancy requirements. A membrane structure shall comply with all other applicable provisions of the appropriate occupancy chapter.

History: Cr. Register, September, 2000, No. 537, eff. 10-1-00.

Subchapter V — Outdoor Theaters

Comm 62.52 Scope. The requirements of this part shall apply to all outdoor theaters now in existence and to outdoor theaters hereafter constructed, except as provided in s. Comm 62.56.

History: Cr. Register, January, 1980, No. 289, eff. 2-1-80; correction made under s. 13.93 (2m) (b) 7., Stats., Register, August, 1985, No. 356.

Comm 62.53 Entrances and exits. All entrances and exits for outdoor theaters shall comply with the regulations of the department of transportation for driveways from property abutting state highways and the following additional requirements:

(1) **NUMBER OF ENTRANCES.** Not more than one entrance shall be provided for each access road but each such entrance may be divided into 2 roadways and channelized to properly provide for vehicles turning right or left from the highway.

(2) **HIGHWAY RIGHT-OF-WAY.** That portion of an entrance or exit lying within the highway right-of-way shall comply with the regulations of the authority in charge of the maintenance of the highway or, in the event this authority has no regulation, it shall comply with regulations prescribed by the state department of transportation.

(3) **NUMBER OF EXITS.** Not more than one exit shall be provided for each access highway but such exit may be suitably channelized to provide for right and left turns to the highway, and not more than one traffic lane shall be permitted for each traffic lane on the highway available to vehicles leaving the theater.

History: Cr. Register, January, 1980, No. 289, eff. 2-1-80.

Comm 62.54 Vehicle storage. (1) AREA NEEDED. A storage area for vehicles, equal to not less than 10% of the theater capacity, shall be provided between the highway and the ticket booth. In all cases, sufficient storage space shall be provided so the vehicles will not back up on the traveled way of the highway. Storage area shall be calculated on the basis of 162 square feet per vehicle.

(2) **HOLD-OVER AREA.** A hold-over storage area having sufficient capacity to accommodate not less than 15% of the theater capacity shall be provided between the ticket booth and the ramp area.

History: Cr. Register, January, 1980, No. 289, eff. 2-1-80.

Comm 62.55 Tower construction. The tower supporting the motion picture screen shall be designed to resist a horizontal wind pressure of not less than 30 pounds for every square foot of exposed surface.

History: Cr. Register, January, 1980, No. 289, eff. 2-1-80.

Comm 62.56 Location of tower. The screen shall be so oriented that the picture is not visible from any major highway. This requirement does not apply to towers erected prior to January 1, 1952.

History: Cr. Register, January, 1980, No. 289, eff. 2-1-80.

Comm 62.57 Concession and motion picture machine booth. (1) MOTION PICTURE BOOTH. The motion picture booth and equipment shall comply in all respects with the requirements of ss. Comm 55.40 through 55.49.

(2) **CONCESSION BUILDINGS.** Concession buildings in connection with outdoor theaters shall comply with the requirements of ch. Comm 54.

History: Cr. Register, January, 1980, No. 289, eff. 2-1-80.

Comm 62.58 Sanitary facilities. (1) TOILET ROOMS. Outdoor theaters and other occupancies under this chapter shall be provided with separate toilet rooms for each sex. Toilet rooms and equipment shall comply with the requirements of ss. Comm 52.50 through 52.64.

(2) **SANITARY FIXTURES.** Toilet fixture ratios shall be provided as required by s. Comm 55.32. In determining the number of fixtures required for toilet rooms in connection with outdoor theaters, the capacity of the theater shall be established by using 2/4 persons for each vehicle accommodated, exclusive of vehicles parked in the waiting or hold-over area. The total number of persons will be considered equally divided between men and women.

(3) **ACCESSIBILITY.** Where toilet rooms are provided for the public and are so located that the patrons must cross the ramp area in order to reach the toilet rooms, a suitable approach or passageway leading to the toilet rooms shall be maintained. Such passageways shall be properly lighted and unobstructed.

History: Cr. Register, January, 1980, No. 289, eff. 2-1-80; r. and recr., Register, August, 1993, No. 452, eff. 3-1-94.

Comm 62.59 Ramps and speaker equipment.

(1) **RAMP SPACING.** Ramps shall be spaced not less than 38 feet apart. The ramps shall be so designed that any vehicle can move from its parked position to the exit driveway without being required to back up.

(2) **SURFACE REQUIRED.** All ramps, parking areas, entrance and exit driveways shall be properly surfaced with a gravel surfacing or better, adequate to withstand the weight of the vehicles accommodated.

(3) **PUBLIC TRANSPORTATION SPEAKER FACILITIES.** Where additional seating space is provided in the theater enclosure for patrons using public transportation facilities, the speaker arrangement shall be such that the sound will be confined to the immediate seating area and not broadcast beyond the theater enclosure.

(4) **SPACING OF SPEAKER POSTS AND ELECTRICAL WIRING.** There shall not be less than 18 feet distance between speaker posts, measured parallel to the ramps, except in seated areas for patrons using

public transportation. All electrical wiring and electrical equipment shall be installed in accordance with the provisions of the Wisconsin state electrical code, volume 2, ch. Comm 16. Each speaker post shall be wired with wire approved for underground use laid in trenches not less than 12 inches in depth.

History: Cr. Register, January, 1980, No. 289, eff. 2-1-80; correction in (4) made under s. 13.93 (2m) (b) 7., Stats., Register, December, 1996, No. 492.

Comm 62.60 Lighting. All entrance and exit driveways shall be adequately lighted and properly marked to avoid congestion and confusion and shall remain lighted throughout the performance and until the audience has left the area.

History: Cr. Register, January, 1980, No. 289, eff. 2-1-80.

Comm 62.61 Speed limit. In every outdoor theater, notices of a permanent character shall be prominently displayed designating the maximum speed limit permitted for cars driven within the area. Parking lights shall be used when cars are moving in the theater enclosure.

History: Cr. Register, January, 1980, No. 289, eff. 2-1-80.

Comm 62.62 Running of engines. At each performance, an instructive trailer shall be shown on the screen informing the patrons of the danger of carbon monoxide poisoning when the engine is running and stating that when it becomes necessary to run the engine, the windows of the vehicle should be opened at least one inch.

History: Cr. Register, January, 1980, No. 289, eff. 2-1-80.

Subchapter VI — Assembly Seating Facilities

Comm 62.70 Scope. The requirements of this subchapter apply to all assembly seating facilities and stadiums intended primarily to support persons for the purpose of spectator seating.

History: Cr. Register, December, 1981, No. 312, eff. 1-1-82; am., Register, August, 1993, No. 452, eff. 3-1-94.

Comm 62.71 Approval and supervision.
(1) APPROVAL OF PLANS. Plans and specifications shall be submitted to the department in accordance with the applicable provisions of ch. Comm 50. The following information shall also be included with each submittal:

(a) A plot plan for outdoor seating facilities showing location of facility relative to property lines and adjacent buildings or structures on the same premises; or a floor plan for indoor seating facilities showing location of seating relative to all required exits, aisles and passageways;

(b) Location and size of all structural members, seating area and number of seats, aisles and guardrail assemblies and number and spacing of all rows; and

(c) Structural calculations or a test report made by an independent testing agency and certified by a Wisconsin registered architect or engineer showing that the dead and live load in the open or partially open position and dead load in the closed position can be safely carried by the supporting structure.

1. Exception. The information specified in this paragraph need not be submitted if the seating facility has been granted a materials approval as specified in sub. (2).

(2) APPROVAL OF DESIGN. The design of each type or model of a seating facility may be approved by the department prior to installation for designs that are structurally repetitive in nature.

Note: See s. Comm 50.19 for further information.

(3) INSTALLATION SUPERVISION. (a) The installation of all permanent seating facilities having more than 5 rows in height shall be erected under the supervision of a Wisconsin registered architect or engineer.

(b) Every temporary seating facility shall be inspected for proper erection in accordance with the manufacturer's instructions prior to initial public occupancy.

History: Cr. Register, December, 1981, No. 312, eff. 1-1-82.

Comm 62.72 Inspection and maintenance. Every seating facility shall be inspected at least annually. Any loose connections, defective or broken members shall be repaired before the facility is used. All repairs and maintenance shall conform with the provisions of chs. Comm 50-64.

History: Cr. Register, December, 1981, No. 312, eff. 1-1-82.

Comm 62.73 Design loads. (1) DEAD LOADS. All seating facilities shall be designed and constructed to support the actual dead weight of all component members.

(2) LIVE LOADS. All seating facilities shall be designed and constructed to support the superimposed minimum live loads specified in Table 62.73. In every case where the live load is greater than the minimum, the actual load shall be used. The most severe distribution, concentration and combination of design loads and forces shall be taken into consideration.

TABLE 62.73
MINIMUM STRUCTURAL LOADINGS

Component or Load Orientation	Load*
Vertical loads:	
Seating structure with load applied over the horizontal projected area	100 PSF
Seats and footboards	120 PLF
Seating platforms	100 PSF
Nonseating areas, such as aisles and passageways	100 PSF
Sway loads in combination with vertical loads:	
Acting parallel to seating	24 PLF
Acting normal to seating, such as front to rear and rear to front	10 PLF
Wind loads in combination with live, dead and sway loads:	
Vertical projected area when occupied	15 PSF
Vertical projected area when unoccupied	30 PSF
Guardrail loads:	
All rail members with load acting vertically and horizontally	50 PLF
Floor and ground loadings:	
Floors supporting seating facilities	See Table 53-I
Ground supporting seating facilities	See ch. Comm 53-Part II

*PSF = Pounds per square foot; PLF = Pounds per linear foot

(3) PARTIAL LOADING. (a) Except as provided in par. (b), structural members in which the stresses are greater under a partial loading than under full loading shall be designed to meet the conditions of greatest stress.

(b) Allowable stresses due to dead and live loads combined with either the wind or sway load or both, may be increased 33¹/₃% provided the structural capacity of the component used is not less than that required for dead and live loads alone.

(4) ANCHORAGE LOADS. Folding or telescoping seating facilities that are attached to a floor or wall shall be anchored to withstand all impact loads in addition to the required live and dead loads.

(5) STRUCTURAL MEMBER OMISSION. All seating facilities shall be designed and manufactured so that if any structural member essential to the strength and stability of the structure is omitted during erection, the absence of such unused member will be self-evident.

(6) FOUNDATIONS, BASE PLATES AND MUDSILLS. (a) Where provided, foundations for seating facilities shall comply with the requirements of ch. Comm 53, Part II.

(b) Mudsills of approved material sized to prevent settlement shall be provided when seating facilities rest directly on the ground. All bearing surfaces between mudsills and base plates shall be in full contact with each other.

History: Cr. Register, December, 1981, No. 312, eff. 1-1-82.

Comm 62.74 Construction requirements. (1) AREA LIMITATIONS. (a) *Combustible construction.* Seating facilities constructed entirely of combustible construction shall not exceed 10,000 square feet in ground area or 200 feet in length.

(b) *Partially noncombustible construction.* Seating facilities shall not exceed 20,000 square feet in ground area or 400 feet in length when constructed of any of the following:

1. Noncombustible framing and combustible seatboards or footboards;
2. Entirely of fire retardant treated wood; or
3. Entirely of members conforming to dimensions for heavy timber construction as specified in s. Comm 51.03 (4).

(c) *Noncombustible construction.* Seating facilities constructed of totally noncombustible construction shall not be limited in ground area or length.

(2) HEIGHT LIMITATION. (a) *Combustible construction.* Seating facilities constructed entirely of combustible materials shall not exceed 20 feet above the ground or floor.

(b) *Noncombustible construction.* Seating facilities constructed of totally or partially noncombustible construction shall not be limited in height.

(c) *Within tents.* The highest level of seat platforms of any portable seating facility within a tent shall not exceed 12 feet above the ground or floor.

(d) *Folding or telescoping.* The highest level of seat platforms of any folding or telescoping seating facility not attached to a wall shall not exceed 12 rows or 11 feet above the floor, whichever is lower.

(3) CLEARANCE LIMITATIONS. A minimum of 7 feet vertical clearance shall be provided between any platform, seatboard or footboard and any ceiling or projection beneath the ceiling.

(4) LOCATION AND SETBACK. Outdoor seating facilities shall be located at least 10 feet from any other building or adjoining property line unless the exterior walls of such adjacent building are of one-hour fire-resistive construction or better and all openings therein are protected with fire-resistive doors and windows as specified in ss. Comm 51.047 and 51.048.

(5) BARRIER-FREE REQUIREMENTS. Permanent, elevated seating facilities such as bleachers and grandstands shall provide accessible seating in accordance with the applicable requirements in ch. Comm 69.

History: Cr. Register, December, 1981, No. 312, eff. 1-1-82; r. and recr. (5), Register, November, 1994, No. 467, 12-1-94.

Comm 62.75 Means of egress. (1) TYPE OF EXITS. (a) Except as provided in par. (b), all required exits from any part of a seating facility shall be doorways, stairways or ramps conforming to the requirements specified in ss. Comm 55.08 through 55.10.

(b) Doorways, stairways and ramps are not required for assembly seating facilities when aisles are not required.

(2) NUMBER OF EXITS. (a) *Outdoor seating.* Every outdoor seating facility, and every balcony or tier considered separately, shall be provided with at least 2 exits located as remote from each other as practicable and leading directly to the outside at grade. If the capacity of any such facility, balcony or tier exceeds 1,000 persons, there shall be at least 3 exits and where the capacity exceeds 4,000 persons, there shall be at least 4 exits.

(b) *Indoor seating.* The number of exits for every indoor seating facility shall comply with the requirements as specified in s. Comm 55.07.

(3) DISTANCE TO EXITS. Exits shall be distributed uniformly to prevent congestion and shall be so located that the line of travel to an exit or to a street, alley or open court is not greater than 150 feet.

(4) AGGREGATE WIDTH OF EXITS. (a) *Outdoor seating.* The total clear width of exits from any outdoor seating facility shall be not less than 22 inches for each 500 persons, or fraction thereof.

(b) *Indoor seating.* The total clear width of exits off of any indoor seating facility shall be not less than 22 inches per 100 persons, or fraction thereof. The required exit width of the room and building shall be determined under the specific occupancy chapter and s. Comm 51.15.

(5) EXIT LIGHTS AND SIGNS. Exit lights and signs shall comply with the requirements as specified in s. Comm 55.11.

(6) AISLES REQUIRED. (a) Except as provided in par. (b), aisles shall be required in all seating facilities.

(b) Aisles may be omitted provided all of the following conditions exist:

1. Seats are without backrests;
2. The rise between rows does not exceed 12 inches;
3. The number of rows does not exceed 20 for outdoor seating facilities or 16 for indoor seating facilities;
4. The row spacing does not exceed 28 inches; and
5. The first seatboard is not more than 20 inches above the ground or floor.

(7) AISLE WIDTH. Aisles having seats on both sides shall be not less than 42 inches in width and aisles having seats on one side only shall be not less than 36 inches wide.

(8) AISLE LOCATION. (a) *Outdoor seating.* For seating not within a building, the number of seats between any seat and an aisle shall not be greater than 20 when the seats are without backrests and 11 when the seats have backrests.

(b) *Indoor seating.* Except as provided in par. (c), the number of seats between any seat and an aisle for seating within a building, shall not be greater than 9 when the seats are without backrests and 6 when the seats have backrests.

(c) *Continental seating.* The number of seats between any seat and an aisle may be increased to 49 where:

1. A minimum unobstructed passage of 22 inches is provided between rows of unoccupied seats; and
2. The unobstructed passage between rows leads to a side aisle on each end of the rows where exit doors are located at no more than 20 foot intervals leading to an exit corridor or exit court.

(9) CROSS AISLES. Where provided, aisles parallel to the seat rows shall be not less than 48 inches in width.

(10) UNOBSTRUCTED MEANS OF EGRESS. No aisle, stair, door or other way of ingress or egress shall be obstructed in any manner while the seating facility is occupied by the public.

History: Cr. Register, December, 1981, No. 312, eff. 1-1-82; am. (4) (b), Register, January, 1994, No. 457, eff. 2-1-94.

Comm 62.76 Seating. (1) SEATING ARRANGEMENTS. A minimum 12-inch spacing shall be provided between the back of each seat and the front of the seat immediately behind it. The seating arrangement shall comply with the spacing requirements specified in Table 62.76. Where the same level is used for both seats and footrests, the width of this level shall be not less than 26 inches.

TABLE 62.76
ROW SPACING REQUIREMENTS

Type of Seating	Minimum Back-to-Back Spacing ¹
Seats without backrests	22
Seats with backrests	30
Chair seating	32

¹All measurements are taken between plumb lines.

(2) FOOTRESTS. Where the same level is not used for both seatboard and footboard, independent footrests shall be provided.

(3) **SEATBOARDS AND FOOTBOARDS.** (a) Seatboards and footboards (footrests) shall have a minimum width of 9 inches.

(b) All seatboards and footboards shall be fastened in place in such a manner that they cannot be accidentally displaced.

(4) **SEAT OCCUPANT WIDTH.** The seating capacity shall be established by allowing one sitting or seat to each 18 inches of length.

(5) **RISE BETWEEN ROWS.** The maximum rise between seat rows shall not exceed 16 inches unless the horizontal row spacing is 40 inches or more.

(6) **STEPS.** Where the rise between rows exceeds 12 inches, intermediate steps shall be provided the full width of the aisles. Such steps shall have a uniform rise of not more than 8 inches and a tread of not less than 10 inches in width. In no case shall the angle of seating exceed 45 degrees.

(7) **OPENINGS.** The design of the seatboards and footboards shall be such that a sphere with a diameter larger than 9 inches will not pass from the seating area to the area beneath the seating where seatboards are more than 5 rows above the ground or floor.

History: Cr. Register, December, 1981, No. 312, eff. 1-1-82.

Comm 62.77 Guardrails. (1) **FRONT RAIL.** Where the front footrest or cross aisle is more than 2 feet above the ground or floor, a guardrail with a midrail shall be provided at the front of such footrest or cross aisle.

(a) *At front footrest.* When required, the rail at the front footrest shall be not less than 30 inches in height.

(b) *At front cross aisle.* When required, the rail at the front cross aisle shall be not less than 36 inches in height.

(2) **BACK AND SIDE RAILS.** (a) Except as provided in par. (b), a guardrail not less than 42 inches in height above the aisle surface or footrest or above the center of the seatboard surface, whichever is adjacent, shall be provided along the back and sides of seating where the seats are more than 4½ feet above the ground or floor.

(b) When a wall or fence is within 6 inches of seating and affords protection equivalent to that required under par (a), guardrails may be omitted.

(3) **OPENINGS BELOW TOP RAIL.** All back, side and front cross aisle guardrails shall have intermediate rails or an ornamental pattern between the footboard or cross aisle and the top rail to prevent the passage of a sphere with a diameter larger than 6 inches.

(4) **CROSS AISLE RAIL.** A guardrail not less than 30 inches in height with a midrail shall be provided along the front edge of cross aisles where the backs of the seats in front of the cross aisle are less than 24 inches above the cross aisle surface.

(5) **LOADING.** All guardrails shall be designed and constructed to withstand a vertical and horizontal load of 50 pounds per linear foot. Loads need not be applied simultaneously.

History: Cr. Register, December, 1981, No. 312, eff. 1-1-82; am. (3), Register, January, 1994, No. 457, eff. 2-1-94.

Comm 62.79 Sanitary facilities. (1) **TOILET ROOMS.** All spectator assembly facilities shall be provided with toilet rooms and sanitary fixtures as specified in s. Comm 55.32. Toilet room construction and equipment shall comply with the requirements as specified in ss. Comm 52.50 through 52.64.

(2) **SANITARY FIXTURES.** In determining the number of sanitary fixtures required for spectator assembly facilities under this subchapter, the capacity shall be considered equally divided between men and women. The number of sanitary fixtures shall be determined using Table 52.32-A but not less than the number determined from Table 52.32-B.

(3) **ACCESSIBILITY.** Where toilet rooms are provided for the public and are located that the patrons must cross a ramp area in order to reach the toilet rooms, a suitable approach or passageway

leading thereto shall be maintained. Such passageways shall be properly lighted and unobstructed access shall be provided.

History: Cr. Register, December, 1981, No. 312, eff. 1-1-82; am. (1), cr. (2) (3), Register, August, 1993, No. 452, eff. 3-1-94.

Comm 62.80 Illumination and emergency lighting. Illumination and emergency lighting of seating facilities shall comply with the provisions as specified in chs. Comm 16 and 73.

History: Cr. Register, December, 1981, No. 312, eff. 1-1-82; correction made under s. 13.93 (2m) (b) 7., Stats., Register, December, 1995, No 480; correction made under s. 13.93 (2m) (b) 7., Stats., Register, December, 1996, No. 492.

Comm 62.81 Fire prevention. (1) **FLAMMABLE MATERIALS.** (a) Except as provided in par. (b), the space under a seating facility shall be kept free from flammable materials and shall not be occupied or used for other than exit purposes.

(b) The space under a seating facility may be used for nonhazardous purposes provided the use is approved in writing by the department and the area is enclosed with at least one-hour fire-resistant rated construction.

(2) **COMBUSTIBLE AND FLAMMABLE LIQUIDS.** Combustible and flammable liquids shall be isolated in accordance with s. Comm 51.08

History: Cr. Register, December, 1981, No. 312, eff. 1-1-82; cr. (2), Register, March, 1991, No. 423, eff. 4-1-91; correction in (2) made under s. 13.93 (2m) (b) 7., Stats., Register, March, 2000, No. 531.

Subchapter VII — Greenhouses

Comm 62.90 Scope. (1) **GENERAL.** The requirements of this subchapter shall apply to all permanent greenhouses, including free standing, attached and lean-to greenhouses.

Note: See s. Comm 62.10 (4) for definition of term "permanent".

(2) **LIMITATIONS.** The requirements of this subchapter do not apply to temporary greenhouses, cold frames and shade covers; solar domes; skylights; greenhouse type structures not used for cultivating plant life; and production greenhouses used as farm operations as specified in s. 102.04 (3), Stats.

History: Cr. Register, December, 1983, No. 336, eff. 1-1-84.

Comm 62.91 Classifications. Greenhouses shall be classified as production greenhouses or mercantile or teaching greenhouses as follows:

(1) **PRODUCTION GREENHOUSES.** Production greenhouses are used for growing plant life on a production basis or for research and public access is restricted.

(2) **MERCANTILE OR TEACHING GREENHOUSES.** Mercantile or teaching greenhouses are used for growing plant life for direct sale or for research, and public access for the purpose of viewing or purchasing the various products is permitted.

Note: Examples of mercantile or teaching greenhouses include but are not limited to nursery greenhouses and greenhouses used by colleges or universities for teaching purposes.

History: Cr. Register, December, 1983, No. 336, eff. 1-1-84.

Comm 62.92 Construction. (1) **FRAME.** Greenhouse frames shall be constructed of concrete, corrosive-resistant metals, heavy timber or fire-retardant treated wood or other approved materials.

(2) **LIGHT-TRANSMITTING PANEL.** Greenhouse roof coverings, exterior walls or interior partitions of glass or approved light-transmitting plastic glazing materials having a minimum of CC 2 rating as specified in s. Comm 51.065 (1) (b) 1. may be used without limitation.

History: Cr. Register, December, 1983, No. 336, eff. 1-1-84.

Comm 62.93 Hazard enclosures and separations. (1) **HAZARD ENCLOSURES.** Hazards shall be enclosed in accordance with s. Comm 51.08.

(2) **NONCOMBUSTIBLE CONSTRUCTION.** Greenhouses of noncombustible construction do not require separation from any other

occupancy or from any building of a different class of construction.

(3) **COMBUSTIBLE CONSTRUCTION.** (a) Greenhouses of combustible construction shall be separated from any other occupancy or from all buildings of a different class of construction by at least 2-hour fire resistive construction in accordance with ss. Comm 51.04 to 51.049.

(b) All openings in the fire-resistive construction shall be protected by self-closing fire-resistive doors in accordance with s. Comm 51.047.

History: Cr. Register, December, 1983, No. 336, eff. 1-1-84; r. and recr., Register, December, 1995, No. 480, eff. 4-1-96; r. and recr., December, 1996, No. 492, eff. 4-1-97; r. and recr., Register, March, 2000, No. 531, eff. 4-1-00.

Comm 62.94 Height and allowable area. (1) HEIGHT. Greenhouses shall be of one story design only.

(2) **ALLOWABLE AREA.** (a) 1. Except as provided in subd. 2., the area of mercantile or teaching greenhouses and production greenhouses shall comply with the requirements of s. Comm 54.01 for the class of construction utilized.

2. The area of production greenhouses may be unlimited if the building is entirely surrounded and adjoined by public space, street or yards not less than 60 feet in width.

3. Air inflated films may be used over a greenhouse of non-combustible construction without affecting the class of construction of the greenhouse.

Note: Typical greenhouse construction satisfies either type 6-metal frame unprotected or type 8-wood frame unprotected construction. Type 6 construction greenhouses consist of metal or other noncombustible material framing and glass covering. Type 8 construction greenhouses consist of wood or other combustible material framing or utilize light-transmitting plastic covering.

History: Cr. Register, December, 1983, No. 336, eff. 1-1-84.

Comm 62.95 Exits. (1) NUMBER OF EXITS. (a) Except as provided in par. (b), every greenhouse shall have at least 2 exits.

(b) Greenhouses with 3,000 or less square feet gross floor area may have one exit.

(2) **EXIT DISTRIBUTION.** (a) Exits shall be distributed or located so that no part of any greenhouse will be more than 150 feet distant from an exit.

(b) Where an approved automatic fire sprinkler system is provided throughout the greenhouse, the exit distance may be increased to 300 feet.

(3) **TYPE OF EXITS.** (a) In production greenhouses, at least one-half of the exits required by this section shall be standard exit doors to grade. The other exits may be sliding doors.

(b) In mercantile or teaching greenhouses, the required exits shall be standard exits to grade as specified in s. Comm 51.15.

History: Cr. Register, December, 1983, No. 336, eff. 1-1-84; emerg. am. (2) (b), eff. 9-6-86; am. (2) (b), Register, November, 1986, No. 371, eff. 12-1-86.

Comm 62.96 Design loads. (1) DEAD LOADS. In addition to normal dead loads as described in s. Comm 53.10, special consideration shall be given to any permanent loads such as, but not limited to, hanging baskets, planters and similar items, that are to be supported by structural members for a continuous period of 30 days or more, and the loads shall be included as part of the dead load.

(2) **CONCENTRATED LOADS.** (a) All roof members, such as but not limited to, purlins, rafters and truss top members, shall be capable of safely supporting a minimum concentrated live load of 100 pounds applied downward and normal to the roof surface at their midspan. In addition, each bottom chord panel point of the roof trusses shall be capable of safely supporting a minimum concentrated live load of 100 pounds.

(b) Maximum allowable deflection for structural members of greenhouses may not exceed 1/120 of span.

(3) **ROOF LOADS.** (a) **Definitions.** The following definitions apply only to the provisions of this section:

1. "Thermal resistance (R)" means a factor which measures the resistance of a material to the transmission of heat.

Note: The smaller the R value, the greater the amount of heat a material will transmit.

2. "Continuously heated single glazed greenhouse" means a single glazed greenhouse which has a constantly maintained interior temperature of at least 50°F., measured at 3 feet above the floor surface, a maintenance attendant is on duty at all times or the greenhouse is equipped with a temperature alarm system to provide warning in the event of a heating system failure and the roof material has a total thermal resistance of less than 1.0.

Note: Air inflated double film greenhouse roof materials and air inflated double film over rigid light-transmitting material satisfy the intent of this definition.

3. "Continuously heated double glazed greenhouse" means a double glazed greenhouse which meets the requirements specified in subd. 2, except that the roof material may have a total thermal resistance of greater than 1.0, but less than 2.0.

4. "Intermittently heated or unheated greenhouse" means any greenhouse that does not meet the requirements specified in subd. 2, or 3.

(b) **Roof loads.** 1. Except as specified in subd. 3., roof structural members subject to snow accumulation shall be designed for the following roof load distributions:

THERMAL CONDITION	MINIMUM ROOF LOAD
Continuously heated single glazed greenhouse	15 Pounds Per Square Foot
Continuously heated double glazed greenhouse	20 Pounds Per Square Foot
Intermittently heated or unheated greenhouse	See s. Comm 53.11 (4) (a)

2. The minimum roof load shall be distributed over the entire area and shall be applied to the horizontal projection of the roof.

3. Free-standing, single glazed, Quonset-type greenhouses not over 4,500 square feet gross ground area shall be designed for a minimum roof load of 10 pounds per square foot.

(c) **Heat transfer barriers.** Heat transfer barriers installed in the interior of the greenhouse may be used in winter months if they are automatically or manually retractable with a 20 minute time period. Permanent heat transfer barriers may not be used.

(d) **Wind loads.** Except as provided in subds. 1. and 2., greenhouses shall be designed to withstand the wind loads specified in s. Comm 53.12.

1. Greenhouses with a maximum height of 30 feet shall be designed to resist a minimum of total wind load of 15 pounds per square foot.

2. Quonset-type greenhouses not over 15 feet in height shall be designed to resist a minimum total wind load of 10 pounds per square foot.

History: Cr. Register, December, 1983, No. 336, eff. 1-1-84; am. (3) (b) 2., Register, January, 1994, No. 457, eff. 2-1-94.

Subchapter VIII — Pedestrian Access Structures Connecting Buildings

Comm 62.97 Scope. The requirements of this subchapter shall apply to all structures used as pedestrian access corridors or walkways between buildings or structures.

History: Cr. Register, August, 1985, No. 356, eff. 1-1-86.

Comm 62.98 General requirements. (1) CONSTRUCTION. All pedestrian access structures shall be of one of the following classes of construction as specified in s. Comm 51.03:

(a) Structures of 4 stories or less, where the open space below elevated structures is counted as a story, shall be of Type 6 construction, or better, and shall be of totally noncombustible construction. "Totally noncombustible construction" in this usage includes but is not limited to compliance with the following subdivisions:

1. Any class A roof may be used if the pedestrian access structure is protected by an automatic sprinkler system as specified in s. Comm 51.23 and the buildings or structures connected to the pedestrian access structure are of Type 6 construction or better.

2. Wall panels consisting of a foam plastic core covered with metal, and complying with the provisions of s. Comm 51.06 (4) (b) 2. b., may be used if the pedestrian access structure is protected

by an automatic sprinkler system as specified in s. Comm 51.23 and the buildings or structures connected to the pedestrian access structure are of Type 6 construction or better.

3. Wall and ceiling finishes with a Class A rating and floor finish material with a Class I rating, as specified in s. Comm 51.07, may be used if the pedestrian access structure is protected by an automatic sprinkler system as specified in s. Comm 51.23.

(b) 1. Except as provided in subd. 2., structures of 5 stories, where the space below elevated structures is counted as a story, shall be of Type 3 construction, or better.

2. Supporting columns in the space beneath elevated structures may be of noncombustible 0-hour rated construction.

(c) 1. Except as provided in subd. 2., structures of 6 or more stories, where the space below elevated structures is counted as a story, shall be of Type 2 construction, or better.

2. Supporting columns in the space beneath elevated structures may be of noncombustible 0-hour rated construction.

(2) FLOORS. (a) Except as provided in par. (b), floor systems separating pedestrian walkway levels shall be of noncombustible one-hour rated construction or better.

(b) The floor system between the lowest pedestrian level and the space below an elevated structure may be of noncombustible 0-hour rated construction.

(3) SEPARATIONS. The pedestrian access structure shall be separated from any building to which it is connected as follows:

(a) 1. Except as provided in subd. 2., the wall of the building within the structure separating the structure from the building shall be of at least 2-hour rated construction.

2. The wall separating the structure from the building need not be of hourly-rated construction provided the structure is more than 20 feet long and all side walls of the structure be open to the atmosphere with the area of the opening being equal to or exceeding 30% of the side wall area.

(b) 1. Except as provided in subd. 2., openings in the wall separating the structure from the building shall be protected with 1½-hour rated fire door assemblies equipped with self-closing devices activated by products of combustion detectors which respond to products of combustion other than heat.

2. a. The opening may be protected with an open head water deluge curtain activated by a products of combustion detector which responds to products of combustion other than heat, in conjunction with solid doors equipped with self-closing devices activated by the water deluge curtain detector.

b. The protection of openings in the wall separating the structure from the building may be omitted provided the structure is more than 20 feet long and all side walls of the structure be open to the atmosphere with the area of the opening being equal to or exceeding 30% of the side wall area.

(4) SEPARATION EQUIVALENCIES. Pedestrian access structures complying with this subchapter may be utilized as division walls, party walls, class of construction separations and occupancy separations.

(5) EXTERIOR PROTECTION. (a) Where the sidewalls of a pedestrian access structure are within 10 feet horizontally of a wall opening of the connected or an adjacent building, the wall opening shall be protected by at least a ¾-hour fire-resistive rated door or window assembly, or the sidewalls of the structure shall be of at least noncombustible one-hour rated construction for a distance of at least 10 feet from the opening or the wall of the connected building.

(b) 1. Except as provided in subd. 2., all wall openings of a connected building directly below or below and within 10 feet horizontally of the pedestrian access structure shall be protected by at least ¾-hour rated fire door or fire window assemblies or the lower floor of the structure shall be of at least noncombustible one-hour rated construction for a distance of at least 20 feet from the wall of the connected building.

2. The fire resistive rated construction and protection of openings specified in subd. 1. may be omitted provided the pedestrian access structure is protected by a complete automatic fire sprinkler system.

(6) LOT LINES. Pedestrian access structures which are constructed over lot lines and connecting buildings with different owners shall conform with subs. (3) and (4).

(7) FIRE DEPARTMENT ACCESS. (a) Except as provided in par. (b), fire department access openings as specified in s. Comm 52.02 (2) shall be provided on each level of the pedestrian access structure.

(b) Fire department access openings may be omitted in structures protected by a complete automatic fire sprinkler system.

History: Cr. Register, August, 1985, No. 356, eff. 1-1-86; r. and recr. (5), Register, March, 1991, No. 423, eff. 4-1-91; r. and recr. (1) (a), renun. (4) to (6) to be (5) to (7) and am. (5) (a), cr. (4), Register, January, 1994, No. 457, eff. 2-1-94.

Comm 62.99 Exiting. (1) NUMBER OF EXITS. (a) Except as provided in sub. (3), every pedestrian access structure, and every level, other than the open space below the structure, shall be provided with at least one exit.

(2) TYPE OF EXITS. (a) Except as provided in par. (b), the exit specified in sub. (1) from the pedestrian access structure shall be an exit door to grade, a stairway to grade constructed as specified in s. Comm 51.16, or a fire escape to grade constructed as specified in s. Comm 51.20.

(b) 1. Open stairways or fire escapes may not be used as an exit for any level more than 55 feet above grade.

2. Type "A" fire escapes may terminate on a platform at least 3 feet long, located not more than 10 feet above grade.

(3) EXCEPTIONS. The exit specified in sub. (1) from the pedestrian access structure may be omitted providing:

(a) The doors connecting the structure and the building are equipped with exit hardware such that a person can pass from the structure into the building; or

(b) The doors connecting the structure and the building are equipped with hardware that requires a key to pass from the building onto the structure, and that key will also open the door allowing passage from the structure back into the building.

(4) EXIT DISTANCE. (a) Except as provided in par. (b), exits shall be distributed or located so that no part of the pedestrian access structure will be more than 200 feet distance from an exit.

(b) Where approved automatic fire sprinklers are provided throughout the pedestrian access structure, an increase in exit distance to 300 feet will be permitted.

History: Cr. Register, August, 1985, No. 356, eff. 1-1-86.

Comm 62.991 Special requirements. (1) PERMITTED USE. Pedestrian access structures may not be used for purposes other than pedestrian walkways.

(2) HEATING AND VENTILATING. (a) Pedestrian access structures need not be heated but shall be provided with ventilation as specified in s. Comm 64.05 for shopping mall corridor areas.

(b) If the pedestrian access structure is to be heated, the structure shall comply with the provisions of ch. Comm 63 based upon the inside design temperature utilized.

(3) STRUCTURAL. (a) The floor of the pedestrian access structure shall be designed and constructed for the actual loading, but in no case shall the design live load be less than 100 pounds per square foot.

(b) The roof of the pedestrian access structure shall be designed and constructed in accordance with the provisions of s. Comm 53.11 (4).

(c) The pedestrian access structure shall be designed and constructed to withstand the wind loads specified in s. Comm 53.12.

(d) Elevated pedestrian access structures shall be designed as bridges, including design factors for sway, sympathetic vibration and deflection.

History: Cr. Register, August, 1985, No. 356, eff. 1-1-86.

Subchapter IX — Amusement Facility & Specialty Event Centers

Comm 62.992 Specialty event centers. (1) APPLICATION. Specialty event centers are assembly halls or places of assembly which include, but are not limited to stadiums, zoos, state or local parks, amusement or theme parks or facilities, state fair grounds, county or local fairgrounds, and specialty event centers.

(2) SANITARY FACILITIES. A sufficient number of permanent or temporary sanitary facilities shall be provided as determined from Table 55.32, but in no case shall the ratio of the number of fixtures to the number of occupants or capacity be less than those specified in Table 54.12-A. The total capacity shall be considered equally divided between men and women unless a different ratio is established and submitted to the department.

History: Cr. Register, August, 1993, No. 452, eff. 3-1-94.

Subchapter X — Mini-Storage Buildings

Comm 62.995 Mini-storage buildings. (1) SCOPE. This subchapter provides the minimum requirements for the design and construction of mini-storage buildings.

(2) HEIGHT, AREA AND CLASS OF CONSTRUCTION. Mini-storage buildings shall be limited to one story and shall not exceed the class of construction and the corresponding area limitations of Table 59.12-1 or 59.12-2 for one story storage garages.

(3) COMPARTMENTALIZATION. Mini-storage buildings shall be divided into areas not greater than 3,000 square feet by 2-hour fire-resistive walls extending from the noncombustible floor to the underside of the roof deck.

(4) CONTENTS. Mini-storage buildings may be utilized for low or moderate hazard material and motor vehicle storage. Storage of high hazard material is prohibited. Uses other than for storage are prohibited except that a rental or manager's office for the storage facility may be provided, subject to the provisions of ch. Comm 54.

Note: See s. A52.011 of Appendix A for further explanatory material.

(5) NUMBER AND LOCATION OF EXITS. (a) Each compartment of a mini-storage building shall be provided with at least one standard exit or overhead door to the outside.

(b) One exit is permitted from a mezzanine floor level, provided the mezzanine is:

1. Open on at least one side to the floor below;
2. Not more than 12 feet above the floor below; and
3. Served by a stairway as specified in s. Comm 51.16, except that the stairway width may be reduced to 3 feet 0 inches.

(c) Exits shall be provided and distributed as follows:

1. No area of a mini-storage building may be more than 100 feet from an exit, unless the entire building is protected by an automatic sprinkler system.

2. No area of a mini-storage building entirely protected by an automatic fire sprinkler system may be more than 200 feet from an exit.

History: Cr. Register, January, 1994, No. 457, eff. 2-1-94; r. (6), Register, December, 1995, No. 480, eff. 4-1-96; r. and recr., March, 1997, No. 495, eff. 4-1-97.

Chapter Comm 63

ENERGY CONSERVATION

Subchapter I — Scope and Purpose

- Comm 63.001 Scope.
Comm 63.002 Purpose.
Comm 63.01 Plans and specifications.

Subchapter II — Definitions

- Comm 63.05 Definitions.

Subchapter III — Building Envelope

- Comm 63.10 Exempt buildings.
Comm 63.11 Air leakage and moisture migration.
Comm 63.12 Daylight credits for skylights.
Comm 63.14 Building envelope thermal performance.
Comm 63.15 Component standards option.
Comm 63.16 System standards option.
Comm 63.165 Design criteria.
Comm 63.17 Material properties.
Comm 63.18 Required calculation procedures.
Comm 63.19 Prohibition of heated sidewalks.

Subchapter IV Equipment And Systems

- Comm 63.20 Minimum equipment efficiencies.
Comm 63.21 Field-assembled equipment and components.
Comm 63.22 Equipment controls.
Comm 63.23 Load calculations for sizing.
Comm 63.24 System and equipment sizing.
Comm 63.25 Separate air distribution systems.
Comm 63.26 Temperature controls.
Comm 63.27 Zone controls.
Comm 63.28 Humidity control.

- Comm 63.29 Insulation, materials and construction.
Comm 63.31 Economizer controls.
Comm 63.32 Electrical motors.

Subchapter V Lighting Power

- Comm 63.40 Scope.
Comm 63.41 Exterior lighting power requirement.
Comm 63.42 Calculation of exterior lighting power.
Comm 63.43 Exterior lighting power allowance.
Comm 63.44 Interior lighting power requirement.
Comm 63.45 Calculation of interior lighting power.
Comm 63.46 Calculation of interior lighting power allowance.
Comm 63.47 Complete building method.
Comm 63.48 Area category method.
Comm 63.49 Activity method.
Comm 63.50 Lighting controls that must be installed.
Comm 63.51 Requirements for lighting control devices.
Comm 63.52 Exit signs.
Comm 63.53 Reduction of single lamp ballasts.

Subchapter VI Nondepletable Energy Source

- Comm 63.60 Buildings utilizing solar, geothermal, wind or other nondepletable energy source.
Comm 63.61 Documentation.

Subchapter VII System Analysis Design

- Comm 63.70 Annual energy consumption.
Comm 63.71 Simulation.
Comm 63.72 Documentation.

Note: Chapter ILHR 63 was revised in December, 1995 effective April 1, 1996. On April 6, 1996 the department of industry, labor and human relations published an emergency rule stating that the effective date of the December, 1995 rule revision was delayed. A permanent rule was adopted in December, 1996 stating that the revised text of ch. ILHR 63, as published, would be effective April 1, 1997.

Note: Chapter Ind 63 was renumbered to be chapter ILHR 63 effective January 1, 1984. Chapter ILHR 63 as it existed on March 31, 1997 was repealed and a new chapter ILHR 63 was created effective April 1, 1997.

Note: Chapter ILHR 63 was renumbered to be Chapter Comm 63 under s. 13.93 (2m) (b) 1., Stats., and corrections made under s. 13.93 (2m) (b) 7., Stats., Register, September, 1998, No. 513.

Subchapter I — Scope and Purpose

Comm 63.001 Scope. (1) **GENERAL.** The provisions of this chapter shall apply to all public buildings and places of employment. These provisions are not retroactive unless specifically stated in the administrative rule. Where different sections of this chapter specify different requirements, the most restrictive requirement shall govern.

(2) **EXEMPT BUILDINGS AND STRUCTURES.** Buildings and structures, or portions thereof, without space heating or cooling, service water heating, or illumination are exempt from the requirements of this chapter that apply to those systems.

(3) **APPLICATIONS TO EXISTING BUILDINGS.** (a) 1. Additions to existing buildings or structures may be made without making the entire building or structure comply, but the addition shall comply with the requirements of this chapter

2. If a system serves both the existing building and the addition, any portion of the system or equipment that is altered shall comply with subch. IV.

(b) 1. Any change of occupancy of a building that would increase the required minimum inside temperature as specified in Table 64.05 shall not be permitted unless the building is made to comply with the requirements of this chapter.

2. Any change of use of a building or space within a building that would increase the minimum inside temperature as specified

in Table 64.05 shall not be permitted unless the building or space is altered to comply with the requirements of this chapter.

3. Alterations to the building envelope governed by subch. III shall comply with one of the following:

a. The alteration shall not increase the rate of heat loss through the portion of the thermal envelope containing the alteration; or

b. The alteration shall not increase the annual energy use from heat gain or loss through the entire thermal envelope; or

c. The thermal envelope shall be brought into compliance with the requirements of subch. III.

4. Any alteration to the equipment and systems governed by subch. IV shall not be permitted unless the portion of the governed equipment or system being altered is brought into compliance with the requirements of subch IV.

(c) 1. Heating and cooling equipment replacement shall comply with the requirements of this chapter.

2. Rooftop fan systems that are replaced shall be provided with economizers that comply with the requirements of this chapter.

Note: It is the intent of the department to have every new building or addition and every change of occupancy meet the energy conservation requirements of this chapter. It is not the intent to prevent a previously built building from installing air conditioning, nor to cause equipment with several years of remaining service to be discarded due to not being able to meet the required efficiencies of this chapter. However, occupancy changes such as building a warehouse and later remodeling it into an office space will not be permitted unless all the requirements of this chapter are met.

(d) 1. New lighting systems installed in conjunction with an increase of conditioned floor area, such as the addition of a mezzanine, shall meet the requirements of this chapter.

2. Alterations to existing lighting systems that increase the connected lighting load of the building or replace more than 50% of the lighting fixtures in the area of the alteration shall meet the requirements of this chapter.

History: Cr. Register, March, 1997, No. 495, eff. 4-1-97.

Comm 63.002 Purpose. The purpose of this chapter is to provide design requirements which will promote efficient utilization of energy in public buildings and places of employment.

(1) **GENERAL.** The intent of this chapter is to provide minimum requirements for construction and equipment to conserve energy.

(2) **FLEXIBILITY IN USE.** It is intended that this chapter be flexible and permit the use of innovative approaches and techniques to achieve effective utilization of energy.

(3) **CONFLICT WITH OTHER RULES.** This chapter is not intended to conflict with any safety or health requirements. Where such conflict occurs, the safety and health requirements shall govern.

History: Cr. Register, March, 1997, No. 495, eff. 4-1-97.

Comm 63.01 Plans and specifications. Architectural and mechanical plans and specifications shall be submitted in accordance with the requirements outlined in ss. Comm 50.07 and 50.12 and shall contain details and data to demonstrate compliance with the requirements of this chapter. Such information shall include, but is not limited to: design criteria, exterior envelope component materials, and resistance values of insulating materials. Size and type of equipment, system and equipment controls and equipment efficiencies shall be submitted with the mechanical plans.

Note: The resistance values for insulating materials are expressed in Fahrenheit degrees per Btu/(hour)(square foot). See A50.12 of the appendix for sample copies of forms.

History: Cr. Register, March, 1997, No. 495, eff. 4-1-97.

Subchapter II — Definitions

Comm 63.05 Definitions. In this chapter:

(1) "Ambient Lighting" is lighting designed to provide a substantially uniform level of illumination throughout an area, exclusive of any provision for special visual tasks or decorative effect. When designed for lower-than-task illuminance used in conjunction with other specific task lighting systems, it is also called "general" lighting.

(2) "Automatic" means self-acting, operating by its own mechanism when actuated by some impersonal influence, such as, a change in current strength, pressure, temperature, or mechanical configuration.

(3) "Automatic time switch control devices" means control devices that are capable of automatically turning loads off and on based on time schedules.

(4) "Building envelope" means the elements of a building that enclose conditioned spaces through which thermal energy may be transferred to or from the exterior or to or from unconditioned spaces.

(5) "Comfort cooling" or "comfort heating" means treating air to control one or more of the following: temperature, relative humidity, or distribution to meet the comfort requirements of the human occupants of the conditioned space.

(6) "Conditioned floor area" or "CFA" means the floor area in square feet of enclosed conditioned space on all floors of a building, as measured at the floor level of the exterior surfaces of exterior walls enclosing the conditioned space.

(7) "Conditioned space" means a cooled space, heated space, or indirectly conditioned space.

(8) "Cooled space" means an enclosed space within a building that is conditioned by a cooling system with a sensible capacity that either exceeds 5 Btu/hr sq ft or is capable of maintaining a space dry-bulb temperature of 90° F or less at design conditions.

(9) "Daylighting control" means a device that automatically regulates the power input to electric lighting near the fenestration to maintain the desired workplace illumination, thus taking advantage of direct or indirect sunlight.

(10) "Deadband" means the range of values within which an input variable can be varied without initiating any noticeable change in the output variable.

(11) "Degree day" means a unit based upon temperature difference and time, used in estimating annual heating or cooling energy consumption. One degree day accrues for each degree of difference between the daily mean temperature and a reference temperature.

(12) "Display lighting" means lighting confined to the area of a display that provides a higher level of illuminance than the level of surrounding ambient illuminance.

(13) "Daylit area" means the space on the floor that is the larger of par. (a) or (b) as follows:

(a) 1. For areas daylit by vertical glazing, the daylit area has the length of 15 feet, or the distance on the floor, perpendicular to the glazing, to the nearest 60-inch or higher opaque partition, whichever is less; and a width of the window plus either 2 feet on each side, the distance to an opaque partition, or one-half the distance to the closest skylight or vertical glazing, whichever is least.

2. For areas daylit by horizontal glazing, the daylit area is the footprint of the skylight plus, in each of the lateral and longitudinal dimensions of the skylight, the lesser of the floor-to-ceiling height, the distance to the nearest 60-inch or higher opaque partition, or one-half the horizontal distance to the edge of the closest skylight or vertical glazing.

(b) The daylit area calculated using a method acceptable to the department.

Note: See Appendix A for additional illustrative information.

(14) "Economizer, air" means a ducting arrangement and automatic control system that allows a cooling supply fan to supply outside air to reduce or eliminate the need for mechanical refrigeration during mild or cold weather.

(15) "Economizer, water" means a system by which the supply air of a cooling system is cooled directly or indirectly or both by evaporation of water or other appropriate fluid in order to reduce or eliminate the need for mechanical refrigeration during some time periods.

(16) "Effective aperture" or "EA" means 1) for windows, the visible light transmittance times the window wall ratio; and 2) for sky lights, the well efficiency times the visible light transmittance times the sky light area times 0.85 divided by the gross exterior roof area.

(17) "Efficacy" means the ratio of light from a lamp to the electrical power consumed, including ballast losses, expressed in lumens per watt.

(18) "Emissivity" means the ratio of the rate of radiant heat energy emitted by a body at a given temperature to the rate of radiant heat energy emitted by a standard called a blackbody, at the same temperature in the same surroundings.

(19) "Exterior envelope" has the same meaning as "building envelope."

(20) "Exterior roof or ceiling" means an exterior partition, or partition separating a conditioned space from an enclosed unconditioned space, that has a slope less than 60° from horizontal, that has conditioned space below, and that is not an exterior door or skylight.

(21) "Exterior roof or ceiling area" means the area of the exterior surface of exterior roof or ceiling.

(22) "Exterior wall" means an exterior partition that is not an exterior floor or soffit, exterior door, exterior roof or ceiling, window, or skylight.

(23) "Exterior wall area" means the area of the opaque exterior surface of exterior walls.

(24) "Fenestration" means any light-transmitting section in a building wall or roof. The fenestration includes glazing material, which may be glass or plastic, framing such as mullions, muntins,

tins, and dividers, external shading devices, internal shading devices, and integral or between glass shading devices.

(25) "Fenestration area" means the total area of fenestration measured using the rough opening and including the glazing material, sash, and frame.

(26) "General lighting" means lighting designed to provide a substantially uniform level of illumination throughout an area, exclusive of any provision for special visual tasks or decorative effect. When designed for lower-than-task illuminance used in conjunction with other specific task lighting systems, it is also called "ambient" lighting.

(27) "Gross exterior wall area" means the gross area of exterior walls separating a conditioned space from the outdoors or from unconditioned spaces as measured on the exterior above grade. It consists of the opaque wall, excluding vents and grills, including between floor spandrels, peripheral edges of flooring, window areas including sash, and door areas.

(28) "Gross floor area" means the sum of the floor areas of the conditioned spaces within the building including basements, mezzanine and intermediate-floored tiers, and penthouses of headroom height 7.5 ft or greater. It is measured from the exterior faces of exterior walls or from the centerline of walls separating buildings, excluding covered walkways, open roofed-over areas, porches and similar spaces, pipe trenches, exterior terraces or steps, chimneys, roof overhangs, and similar features.

(29) "Gross floor area over outside or unconditioned spaces" means the gross area of a floor assembly separating a conditioned space from the outdoors or from unconditioned spaces as measured from the exterior faces of exterior walls or from the center line of walls separating buildings. The floor assembly shall be considered to include all floor components through which heat may flow between indoor and outdoor or unconditioned environments.

(30) "Gross lighted area" or "GLA" means the sum of the total lighted areas of a building measured from the inside of the perimeter walls for each floor of the building.

(31) "Gross roof area" means the gross area of a roof assembly separating a conditioned space from the outdoors or from unconditioned spaces, measured from the exterior faces of exterior walls or from the centerline of walls separating buildings. The roof assembly shall be considered to include all roof or ceiling components through which heat may flow between indoor and outdoor environments including skylights but excluding service openings.

(32) "Gross exterior roof area" means the sum of the skylight area and the exterior roof/ceiling area.

(33) "Gross exterior wall area" means the sum of the window area, door area and exterior wall area.

(34) "Heat capacity" or "HC" means the amount of heat necessary to raise the temperature of a given mass one degree. Numerically, it is the mass multiplied by the specific heat.

(35) "Heated space" means an enclosed space within a building that is conditioned by a heating system with an output capacity either exceeds 10 Btu/hr sq ft or is capable of maintaining a space dry-bulb temperature of 50°F or more at design conditions.

(36) "Heating, ventilating, and air conditioning system" or "HVAC system" means the equipment, distribution network, and terminals that provide either collectively or individually the process of heating, ventilating, or air conditioning to a building.

(37) "Humidistat" means a device that is capable of being set to prevent the use of fossil fuel or electricity to humidify air above 30% relative humidity or dehumidify air to below 60% relative humidity, or both.

(38) "Indirectly conditioned space" means an enclosed space including, but not limited to, unconditioned volume in atria, that is not directly conditioned space; and either has an area-weighted

heat transfer coefficient to directly conditioned space exceeding that to the outdoors or to unconditioned space, or is a space through which air from directly conditioned spaces is transferred at a rate exceeding three air changes per hour.

(39) "Listed space area" or "LS" means any interior space with an identified area of activities for which a lighting power budget is calculated and listed in the lighting power allowance determination.

(40) "Lumen maintenance control device" means a device capable of automatically adjusting the light output of a lighting system throughout a continuous range to provide a preset level of illumination.

(41) "Luminaire" means a complete lighting unit consisting of at least one lamp and the parts designed to distribute the light, to position and protect the lamp, to connect the lamp to the power supply and ballasting, when applicable. Luminaires are commonly referred to as "lighting fixtures" or "instruments."

(42) "Manual" means capable of being operated by personal intervention.

(43) "Mass wall" means a wall assembly with a heat capacity (HC) greater than or equal to 5 Btu/ft²°F.

(44) "Mass wall insulation position" means:

(a) Exterior insulation position: a wall having all or nearly all of its mass exposed to the room air with the insulation on the exterior of that mass.

(b) Integral insulation position: a wall having mass exposed to both room and outside air with substantially equal amounts of mass on the inside and outside of the insulation layer.

(c) Interior insulation position: a wall not meeting either par. (a) or (b), particularly a wall having most of its mass external to an insulation layer.

(45) "Medical and clinical care" means the promotion of the condition of being sound in body or mind through medical, dental or psychological examination and treatment.

(46) "Multiscene dimming system" means a lighting control device that has the capability of setting light levels throughout a continuous range, and that has pre-established settings within the range.

(47) "Occupant-sensing device" means a device that automatically controls the lights based on occupancy.

(48) "Opaque areas" means all exposed areas of a building envelope which enclose conditioned space except fenestration areas and building service openings such as vents and grilles.

(49) "Ornamental chandeliers" means ceiling-mounted, close-to-ceiling, or suspended decorative luminaires that use glass, crystal, ornamental metals, or other decorative material and that typically are used in hotels/motels, restaurants, or churches as a significant element in the interior architecture.

(50) "Precision commercial or industrial work" means an art, craft, or manufacturing operation requiring a certain degree of refinement.

(51) "Private driveways, walkways, and parking lots" means exterior transit areas that are associated with a commercial or residential building and intended for use solely by the employees or tenants and not by the general public.

(52) "Public driveways, walkways, and parking lots" means exterior transit areas that are intended for use by the general public.

(53) "Recooling" means lowering the temperature of air that has been previously heated by a heating system.

(54) "Recovered energy" means energy utilized from an energy-using system which would otherwise be wasted or not contribute to a desired end use.

(55) "Reduced flicker operation" means the operation of a light, in which the light has a visual flicker less than 30% for frequency and modulation.

(56) "Reheating" means raising the temperature of air that has been previously cooled either by refrigeration or an economizer system.

Note: Introducing outdoor air necessary to meet ventilation requirements or to assure adequate indoor air quality is not considered to be cooling.

(57) "Reset" means adjustment of the controller set point to a higher or lower value automatically or manually.

(58) "Sconce" means a wall mounted decorative light fixture.

(59) "Shading coefficient" or "SC_x" means the ratio of solar heat gain through fenestration, with or without integral shading devices, to that occurring through unshaded 1/8-in. thick clear double strength glass.

(60) "Shell building" means a building for which the envelope is designed, constructed, or both prior to knowing the occupancy type.

Note: See also speculative building.

(61) "Speculative building" means a building for which the envelope is designed, constructed, or both prior to the design of the lighting, HVAC systems, or both. A speculative building differs from a shell building in that the intended occupancy is known for the speculative building.

Note: See also shell building.

(62) "Support area" means an area for functions that are different from but necessary to accomplish the main activity or purpose of other listed space areas.

(63) "Tandem wiring" means pairs of luminaires operating with one lamp in each luminaire powered from a single two-lamp ballast contained in the other luminaires.

(64) "Task oriented lighting" means lighting that is designed specifically to illuminate a task location, and that is generally confined to the task location.

(65) "Thermal break" means an element of low thermal conductivity placed in an assembly to reduce the flow of heat between highly conductive materials.

(66) "Thermal conductance" or "C" means the constant time rate of heat flow thorough a unit area of a body induced by a unit temperature difference between the surfaces, expressed in Btu/h-ft²·F or equivalent units. It is the reciprocal of thermal resistance.

(67) "Thermal resistance" or "R" means the reciprocal of thermal conductance, 1/C expressed in h-ft²·F/Btu or equivalent units. The total thermal resistance of an assembly is 1/U_o.

(68) "Thermal transmittance" or "U" means the overall coefficient of heat transfer from fluid to fluid. It is the time rate of heat flow per unit area under steady conditions from the fluid on the warm side of the barrier to the fluid on the cold side, per unit tem-

perature difference between the 2 fluids, expressed in Btu/h-ft²·F or equivalent units.

(69) "Thermal transmittance, overall" or "U_o" means the gross overall (area weighted average) coefficient of heat transfer from air to air or fluid to fluid for a gross area of the building envelope, expressed in Btu/h-ft²·F or equivalent units. The U_o value applies to the combined effect of the time rate of heat flows through the various parallel paths such as windows, doors, and opaque construction areas comprising the gross area of one or more building envelope components such as walls, floors, and roof or ceiling.

(70) "Thermostat" means an automatic control device responsive to temperature.

(71) "Throw distance" means the distance between the luminaire and the center of the plane on a subject lit by the luminaire.

(72) "Unconditioned space" means a space within a building that is not a conditioned space.

Note: See conditioned space.

(73) "Unlisted space" means the difference in area between the gross lighted area and the sum of all listed space areas.

(74) "Variable air volume HVAC system" or "VAV HVAC system" means HVAC systems that control the dry-bulb temperature within a space by varying the volume of air supply to the space.

(75) "Visible light transmittance" or "VLT" means the ratio expressed as a decimal of visible light that is transmitted through a glazing material to the light that strikes the material.

(76) "Wall heat capacity" or "HC" means the sum of products of the mass of each individual material in the wall per unit area of wall surface times its individual specific heat, Btu/(ft²·F).

(77) "Well efficiency" means the ratio of the amount of visible light leaving a skylight well to the amount of visible light entering the skylight well and is calculated as follows:

(a) for rectangular wells:

$$\frac{\text{Well height (well length + well width)}}{2 \times \text{well length} \times \text{well width}} = \text{the well index}$$

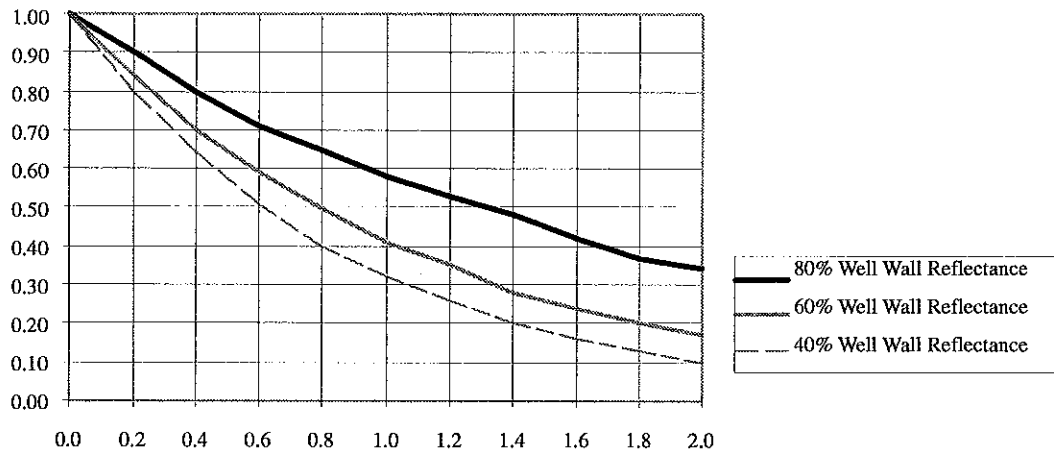
; or

(b) for irregular shaped wells:

$$\frac{\text{Well height} \times \text{well perimeter}}{4 \times \text{well area}} = \text{the well index}$$

(c) The length, width, perimeter, and area expressed in pars. (a) and (b) are measured at the bottom of the well. The well index and the weighted average well wall reflectance are used in Figure 63.02 to determine the well efficiency.

Figure 63.02 Well Efficiency



Information taken from: Fig 7-38, IES Lighting Handbook, 1984 Reference

(78) "Window" means glazing that is not a skylight.

(79) "Window area" means the area of the surface of a window, plus the area of the frame, sash, and mullions.

(80) "Window wall ratio" means the ratio of the window area, including glazed areas of doors, to the gross exterior wall area.

(81) "Zone" means a space or group of spaces within a building with any combination of heating, cooling, or lighting requirements sufficiently similar so that desired conditions can be maintained throughout by a single controlling device.

History: Cr. Register, March, 1997, No. 495, eff. 4-1-97.

Subchapter III — Building Envelope

Comm 63.10 Exempt buildings. This subchapter applies to buildings or separately enclosed identifiable areas that have a mechanical space heating or air conditioning system.

History: Cr. Register, March, 1997, No. 495, eff. 4-1-97.

Part 1 — General Requirements

Comm 63.11 Air leakage and moisture migration.

(1) GENERAL. The requirements of this section apply to those building components that separate interior building conditioned space from the outdoors or from unconditioned spaces or crawl spaces. Compliance with the criteria for air leakage through building components shall be determined by tests conducted in accordance with specified standards.

(2) AIR LEAKAGE REQUIREMENTS FOR FACTORY MANUFACTURED FENESTRATION AND DOORS. (a) Factory manufactured fenestration shall meet one of the following standards for air leakage as adopted in s. Comm 51.25:

1. ANSI/AAMA 101 Aluminum and Poly Vinyl Chloride (PVC) Prime Windows and Glass Doors.
2. ASTM D 4099 Specification for Poly Vinyl Chloride (PVC) Prime Windows.
3. ANSI/NWDA I.S.2 Wood Windows (Improved Performance Rating Only).

(b) Factory manufactured sliding doors shall meet one of the following standards for air leakage:

1. ANSI/AAMA 101 Aluminum and Poly Vinyl Chloride (PVC) Prime Windows and Glass Doors.
2. ANSI/NWDA I.S.3 Wood Sliding Patio Doors.

(c) Factory manufactured commercial entrance swinging or revolving doors shall limit air leakage to a rate not to exceed 1.25 cfm/ft² of door area when tested at standard test conditions in accordance with ASTM E 283.

(d) Factory manufactured residential swinging doors shall limit air leakage to a rate not to exceed 0.5 cfm/ft² of door area when tested at standard test conditions in accordance with ASTM E 283.

Note: The term "factory manufactured" does not apply to units constructed or fabricated in the field or to units assembled from individual components at a lumber yard or building material center.

(3) AIR LEAKAGE REQUIREMENTS FOR EXTERIOR ENVELOPE JOINTS AND PENETRATIONS. Exterior joints, cracks, and holes in the building envelope shall be caulked, gasketed, weather stripped, or otherwise sealed. Such joints include the following:

- (a) Around window or door frames.
- (b) Between wall or floor and foundation.
- (c) Between wall and roof or roof decking.
- (d) Through wall panels and top and bottom plates in exterior walls.
- (e) At penetrations of utility services or other service entry through walls, floors, and roofs.
- (f) Between wall panels particularly at corners and changes in orientation.
- (g) Between wall and floor where floor penetrates wall.
- (h) Around penetrations made through the insulated envelope by chimneys, flue vents, or attic hatches.

Note: Sealing methods should be designed to be compatible with the chimney or vent listing.

(4) MOISTURE CONDENSATION. The design of buildings shall not create conditions of accelerated deterioration from moisture condensation.

Note: Vapor retarders and ventilation should be considered to prevent moisture from collecting within the envelope. The principles of ASHRAE Handbook, Fundamentals Volume, may be used as a guide.

History: Cr. Register, March, 1997, No. 495, eff. 4-1-97.

Comm 63.12 Daylight credits for skylights.

(1) When determining building roof compliance using either the component standards of s. Comm 63.15 or the system standards of s. Comm 63.16, daylight credits for skylights may be used if the criteria of this section are met.

Note: Skylights used in conjunction with automatic lighting controls for daylighting can significantly reduce the lighting energy consumption thereby more than offsetting the increase in envelope heat transfer.

(2) Skylights for which daylight credit is taken may be excluded from the calculations of the overall thermal transmittance value of the roof assembly (U_{or}) if all of the following conditions are met:

(a) The opaque roof thermal transmittance value U_{or} does not exceed the values determined for the roof within the appropriate Alternate Component Package (ACP) table selected under s. Comm 63.15 (1) or by s. Comm 63.16.

(b) The criteria of section 8.4.8 of ASHRAE Standard 90.1 are met.

(c) Areas for vertical glazing, or glazing within 30° of vertical of clerestories or roof monitors shall be included in the wall fenestration calculation of s. Comm 63.15 or 63.16.

Note: See A63.12 of the appendix for general information on the criteria of section 8.4.8 of ASHRAE Standard 90.1.

History: Cr. Register, March, 1997, No. 495, eff. 4-1-97.

Part 2 – Thermal Performance

Comm 63.14 Building envelope thermal performance. (1) Except as provided in subs. (2) and (3), building envelopes shall comply with either the component standards of s. Comm 63.15 or the system standards of s. Comm 63.16. The calculation procedures of s. Comm 63.18 shall be used to show compliance.

(2) Buildings and areas of buildings that are used as factories shall comply with s. Comm 63.165.

(3) Buildings and areas of buildings that are used as warehouses that have documentation provided to verify that the HVAC system to be installed does not use energy primarily to provide human comfort shall comply with s. Comm 63.165.

Note: See s. Comm 63.10 for exempt buildings and spaces.

History: Cr. Register, March, 1997, No. 495, eff. 4-1-97.

Comm 63.15 Component standards option. This section describes the component standards for building envelope thermal performance. Because component requirements consider the effect of solar gain as well as conductive heat transfer, the requirements for each component shall be met independently under this option. The wall and roof trade-off exception in sub. (3) may be used with this option. The System Analysis Design Method of Subchapter III shall be used to demonstrate the acceptability of trade-offs between component energy-conserving features. Separate occupancies in the same building shall meet the requirements of this section independently.

(1) DETERMINATION OF APPROPRIATE ACP TABLE. The appropriate alternate component package or ACP table shall be determined based on building location using Figure 63.15.

(2) MAXIMUM ALLOWABLE WINDOW WALL RATIO. The percentage of windows, including glazed areas of doors, relative to the gross external wall area of the building shall be less than or equal to the maximum allowable window wall ratio chosen from the appropriate ACP table for the glazing type of the building. The window wall ratio is the total area of window assemblies, including glazed areas of doors, divided by the total gross exterior wall area, considering all elevations of the building. The maximum allowable window wall ratio shall be determined using the following steps:

(a) Select the Shading Coefficient (SC_x) range that is no less than the fenestration SC_x including permanently installed internal, integral and external shading devices, but excluding the effect of external shading projections. Note that this includes curtains, shades, or blinds that are permanently installed. For a shell or

speculative building for which the envelope is designed or constructed prior to the design of the lighting, HVAC systems, or both, only those shading devices that are part of the design when it is being evaluated for compliance shall be considered when determining compliance.

Note: Refer to ASHRAE Handbook, Fundamentals Volume, Chapter 27 for more information on shading coefficients. Shading coefficients for fenestration are obtained from the manufacturer. See also s. Comm 63.18 (4).

(b) Select appropriate fenestration type. This is determined by the thermal transmittance value (U_{of}) of the fenestration assembly. The U_{of} of all assemblies must fall within the range, or lower, to determine the maximum window wall ratio, or an area-weighted average thermal transmittance value may be used.

(3) WALL AND ROOF TRADE-OFF. Trade-offs between the above grade exterior wall opaque areas and the gross roof area shall be allowed if either of the following conditions are met:

(a) The thermal transmittance, overall value (U_o) for any above grade exterior opaque wall area or gross roof area may be increased or decreased, provided that the total annual energy use due to heat gain and loss for the building envelope shall be less than or equal to the total annual energy use due to heat gain and loss resulting from the use of the values in the appropriate ACP table given in Figure 63.15.

Note: The latest version of the ENVSTDD computer program may be used to determine required thermal transmittance values in lieu of the ACP tables. ENVSTDD is the computer program included in the ASHRAE Standard 90.1.

(b) A submittal to the department for review and approval, incorporating recognized engineering practices, that the annual energy use due to heat gain and loss for the building envelope shall be less than or equal to that established in par (a).

(4) THERMAL TRANSMITTANCE VALUES FOR ROOFS, WALLS NEXT TO UNCONDITIONED SPACES, AND FLOORS OVER UNCONDITIONED SPACES. (a) The U-values for the building roofs, walls next to unconditioned spaces, and floors over unconditioned spaces shall be less than or equal to those listed in the appropriate ACP table given in Figure 63.15.

(b) Skylights for which daylight credit cannot be taken in accordance with s. Comm 63.12 shall be included in the calculation of the overall thermal transmittance value of the roof assembly (U_{or}).

(c) Unconditioned below-grade spaces that have floor or ceiling assemblies insulated as specified on the appropriate ACP table do not require below-grade wall insulation.

(5) THERMAL RESISTANCE VALUE FOR SLAB-ON-GRADE FLOORS. (a) Unheated slab-on-grade floors shall have insulation around the perimeter of the floor with the thermal resistance (R_u) of the insulation as listed in the appropriate ACP table.

(b) For heated slabs-on-grade, the required minimum R-value shall be the R-value for the unheated slab-on-grade plus 2.0.

(c) The slab insulation specified shall extend either in a vertical plane downward from the top of the slab for the minimum distance given in the appropriate ACP table or downward to the bottom of the slab then in a horizontal plane beneath the slab or outward from the building for the minimum distance given in the ACP table. Vertical insulation shall not be required to extend below the foundation footing.

(d) The R-value and dimensions required for slabs refer only to the building insulation materials. Insulative continuity shall be maintained in the design of slab edge insulation systems. Continuity shall be maintained from the wall insulation through the intersection of the slab, wall and footing to the body of the slab edge insulation.

History: Cr. Register, March, 1997, No. 495, eff. 4-1-97.

**Figure 63.15
Degree Day Regions**

REGIONS	ACP TABLE
1,2,4	A
3,5,6,7,8	B
9, 10, 11	C



Figure 63.15 (Continued)
 Alternate Component Package
 ACP Table A

Part A1: Maximum Window Area/Gross Exterior Wall Area						
Exterior Wall U_o	Shading Coefficient Range SC_x	U_{of} Range				
		0.60 to 0.56	0.55 to 0.51	0.50 to 0.46	0.450 to 0.41	≤ 0.40
≤ 0.06	0.80 - 0.71	0.20	0.21	0.23	0.25	0.27
	0.70 - 0.61	0.20	0.22	0.24	0.26	0.28
	0.60 - 0.51	0.21	0.22	0.25	0.27	0.30
	0.50 - 0.41	0.21	0.23	0.25	0.28	0.31
	≤ 0.40	0.21	0.23	0.26	0.29	0.33
0.061 to 0.070	0.80 - 0.71	0.18	0.20	0.21	0.23	0.25
	0.70 - 0.61	0.18	0.20	0.22	0.24	0.27
	0.60 - 0.51	0.19	0.21	0.23	0.25	0.28
	0.50 - 0.41	0.19	0.21	0.23	0.26	0.30
	≤ 0.40	0.19	0.21	0.24	0.27	0.31
0.071 to 0.080	0.80 - 0.71	0.16	0.18	0.20	0.22	0.24
	0.70 - 0.61	0.17	0.18	0.20	0.23	0.25
	0.60 - 0.51	0.17	0.19	0.21	0.23	0.26
	0.50 - 0.41	0.17	0.19	0.21	0.24	0.27
	≤ 0.40	0.18	0.19	0.22	0.25	0.28
0.081 to 0.090	0.80 - 0.71	0.15	0.16	0.18	0.20	0.22
	0.70 - 0.61	0.15	0.17	0.18	0.21	0.23
	0.60 - 0.51	0.15	0.17	0.19	0.21	0.24
	0.50 - 0.41	0.16	0.17	0.19	0.22	0.25
	≤ 0.40	0.16	0.17	0.20	0.22	0.26

Part A2: Other Criteria
Roof Max $U_o = 0.040$
Wall Adjacent to Unconditioned Space Max $U_o = 0.10$
Floor Over Unconditioned Space Max $U_o = 0.040$
Wall Below Grade Min R-Value = 13

Part A3: Unheated Slab-On-Grade Minimum R-Value			
Insulation Orientation	Length of Insulation		
	24"	36"	48"
Horizontal	R=18	R=15	R=11
Vertical	R=8	R=6	R=4

Figure 63.15 (continued)
 Alternate Component Package
 ACP Table B

Part B1: Maximum Window Area/Gross Exterior Wall Area						
Exterior Wall U_o	Shading Coefficient Range SC_x	U_{of} Range				
		0.60 to 0.56	0.55 to 0.51	0.50 to 0.46	0.45 to 0.41	≤ 0.40
≤ 0.06	0.80 - 0.71	0.20	0.21	0.22	0.23	0.24
	0.70 - 0.61	0.21	0.22	0.24	0.25	0.27
	0.60 - 0.51	0.22	0.24	0.25	0.27	0.29
	0.50 - 0.41	0.24	0.25	0.27	0.30	0.32
	≤ 0.40	0.25	0.27	0.29	0.32	0.35
0.061 to 0.070	0.80 - 0.71	0.19	0.20	0.21	0.22	0.23
	0.70 - 0.61	0.20	0.21	0.22	0.24	0.25
	0.60 - 0.51	0.21	0.23	0.24	0.26	0.28
	0.50 - 0.41	0.22	0.24	0.26	0.28	0.31
	≤ 0.40	0.24	0.26	0.28	0.31	0.34
0.071 to 0.080	0.80 - 0.71	0.18	0.19	0.20	0.21	0.23
	0.70 - 0.61	0.19	0.20	0.21	0.23	0.24
	0.60 - 0.51	0.20	0.21	0.23	0.25	0.27
	0.50 - 0.41	0.21	0.23	0.25	0.27	0.29
	≤ 0.40	0.22	0.24	0.27	0.29	0.32
0.081 to 0.090	0.80 - 0.71	0.17	0.18	0.19	0.20	0.21
	0.70 - 0.61	0.18	0.19	0.20	0.21	0.23
	0.60 - 0.51	0.19	0.20	0.21	0.23	0.25
	0.50 - 0.41	0.20	0.21	0.23	0.25	0.28
	≤ 0.40	0.21	0.23	0.25	0.27	0.30

Part B2: Other Criteria
Roof Max $U_o = 0.045$
Wall Adjacent to Unconditioned Space Max $U_o = 0.11$
Floor Over Unconditioned Space Max $U_o = 0.040$
Wall Below Grade Min R-Value = 12

Part B3: Unheated Slab-On-Grade Minimum R-Value			
Insulation Orientation	Length of Insulation		
	24"	36"	48"
Horizontal	R=18	R=15	R=11
Vertical	R=8	R=6	R=4

Figure 63.15 (continued)
Alternate Component Package
ACP Table C

Part C1: Maximum Window Area/Gross Exterior Wall Area						
Exterior Wall U_o	Shading Coefficient Range SC_x	U_{of} Range				
		0.60 to 0.56	0.55 to 0.51	0.50 to 0.46	0.45 to 0.41	≤ 0.40
≤ 0.06	0.80 – 0.71	0.20	0.21	0.22	0.22	0.23
	0.70 – 0.61	0.22	0.23	0.24	0.25	0.26
	0.60 – 0.51	0.23	0.25	0.26	0.27	0.29
	0.50 – 0.41	0.25	0.27	0.29	0.30	0.32
	≤ 0.40	0.27	0.29	0.32	0.34	0.37
0.061 to 0.070	0.80 – 0.71	0.19	0.20	0.21	0.22	0.23
	0.70 – 0.61	0.21	0.22	0.23	0.24	0.25
	0.60 – 0.51	0.22	0.24	0.25	0.26	0.28
	0.50 – 0.41	0.24	0.26	0.27	0.29	0.31
	≤ 0.40	0.26	0.28	0.30	0.33	0.35
0.071 to 0.080	0.80 – 0.71	0.18	0.19	0.20	0.21	0.22
	0.70 – 0.61	0.20	0.21	0.22	0.23	0.24
	0.60 – 0.51	0.21	0.23	0.25	0.26	0.27
	0.50 – 0.41	0.23	0.25	0.26	0.28	0.30
	≤ 0.40	0.25	0.27	0.29	0.31	0.34
0.081 to 0.090	0.80 – 0.71	0.17	0.18	0.19	0.20	0.21
	0.70 – 0.61	0.19	0.20	0.21	0.22	0.23
	0.60 – 0.51	0.20	0.22	0.23	0.24	0.26
	0.50 – 0.41	0.22	0.23	0.25	0.27	0.29
	≤ 0.40	0.24	0.26	0.28	0.30	0.33

Part C2: Other Criteria
Roof Max $U_o = 0.049$
Wall Adjacent to Unconditioned Space Max $U_o = 0.11$
Floor Over Unconditioned Space Max $U_o = 0.040$
Wall Below Grade Min R-Value = 11

Part C3: Unheated Slab-On-Grade Minimum R-Value			
Insulation Orientation	Length of Insulation		
	24"	36"	48"
Horizontal	R=18	R=15	R=11
Vertical	R=8	R=6	R=4

Comm 63.16 System standards option. To comply with the system standards for building envelope thermal performance, the building shall comply with section 8.6 of ASHRAE standard 90.1 as adopted in s. Comm 51.25 or with the system analysis design of s. Comm 63.70 to 63.72 applied to the thermal envelope alone. Building site climate data shall be determined using Wisconsin Division of State Energy Statistics or other source acceptable to the department.

Note: Section 8.6 of ASHRAE 90.1 requires use of the latest version of the ENVSTD computer program. ENVSTD is the computer program included in the

ASHRAE 90.1 Standard.

History: Cr. Register, March, 1997, No. 495, eff. 4-1-97.

Comm 63.165 Design criteria. (1) THERMAL PERFORMANCE. (a) Except as provided in par. (b), the thermal performance values for the exterior envelope of buildings or areas of buildings that are warehouses that meet the criteria of s. Comm 63.14 (3), or that are factories shall not exceed the values in Table 63.165-1. The calculation procedures of s. Comm 63.18 shall be used to show compliance.

Table 63.165-1

Thermal Performance Values

Number of Stories	Thermal Performance Values*
1-2	12
3-4	13
5-7	16
8-12	18
13-20	20
Over 20	21

*Expressed in Btu/hour/square foot of above-grade exterior envelope. See s. Comm 63.23 (2) and (3) for design conditions.

(b) The thermal performance values specified in par. (a) may be increased or decreased provided the U-value for other components is decreased or increased so the total heat gain or loss for the entire building envelope and floor area does not exceed the total heat gain or loss resulting from conformance to the values specified in this section.

(2) FLOORS OVER UNCONDITIONED SPACES. The overall heat transmission coefficient (U-value) for floors of heated or mechanically cooled spaces over unconditioned spaces shall not

exceed 0.08 Btu/F. Sq. Ft. hour.

(3) SLAB-ON-GRADE PERIMETER INSULATION. For slab-on-grade floors with or without a grade beam, a foundation bearing wall or a foundation frost wall, the thermal resistance of the insulation around the perimeter of the floor shall not be less than the values shown in Table 63.165-2. The insulation shall extend 48 inches in the vertical or horizontal direction or combination thereof with a total dimension of 48 inches. Slab-on grade perimeter insulation shall be moisture resistant.

Table 63.165-2

Perimeter Insulation Requirements¹

Slab-on-grade Perimeter Insulation		Zone 1	Zone 2	Zone 3	Zone 4
R = °F Sq. Ft. Hour Btu	Unheated Slabs	6.7	6.2	5.9	5.2
	Heated Slabs ²	9.3	9.0	8.6	8.2

¹See Fig. 63.23 for zone definitions.

²Heated slabs have piping, duct work or other heat distribution system components embedded in or under them.

History: Cr. Register, March, 1997, No. 495, eff. 4-1-97.

Part 3 - Calculations and Standards

Comm 63.17 Material properties. (1) When available, information on thermal properties, performance of building envelope sections, and components and heat transfer shall be obtained from ASHRAE Handbook, Fundamentals Volume, adopted in s. Comm 51.25.

(2) (a) When the information is not available from ASHRAE Handbook, Fundamentals Volume, the data may be obtained from manufacturer's information or laboratory or field test measurements. If laboratory or field test measurements are used for envelope heat transmission, they shall be obtained using one of the following test methods adopted in s. Comm 51.25:

1. GUARDED HOT PLATE: ASTM C 177;
2. HEAT FLOW METER: ASTM C 518;
3. GUARDED HOT BOX: ASTM C 236;
4. CALIBRATED HOT BOX: ASTM C 976; or
5. PIPE INSULATION: ASTM C 335.

(b) For foam plastic insulations that use a gas other than air as the insulating medium, laboratory or field tests shall be conducted on representative samples that have been aged for the equivalent of 5 years or until the R-Value has stabilized. The tests shall be conducted by an independent third party and shall be submitted

for department review and approval in accordance with s. Comm 50.19.

History: Cr. Register, March, 1997, No. 495, eff. 4-1-97.

Comm 63.18 Required calculation procedures. The following procedures shall be used to calculate the thermal performance of above- and below-grade envelope sections of any building that is heated or mechanically cooled.

(1) OVERALL THERMAL TRANSMITTANCE (U_o). The overall thermal transmittance of the building envelope assembly shall be calculated in accordance with the equation given below.

$$U_o = \sum U_i A_i / A_o$$

$$= (U_1 A_1 + U_2 A_2 + \dots + U_n A_n) / A_o$$

where:

U_o = The area-weighted average thermal transmittance of the gross area of an envelope assembly; that is the exterior wall assembly including fenestration and doors, the roof and ceiling assembly, and the floor assembly, Btu/hft²°F.

A_o = The gross area of the envelope assembly, ft².

U_i = The thermal transmittance of each individual path of the envelope assembly, for example, the opaque portion of the wall assembly, Btu/hft²°F. U_i also equals 1/R_i where R_i is the total resistance to heat flow of an individual path through an envelope assembly.

A_1 = The area of each individual element of the envelope assembly, ft².

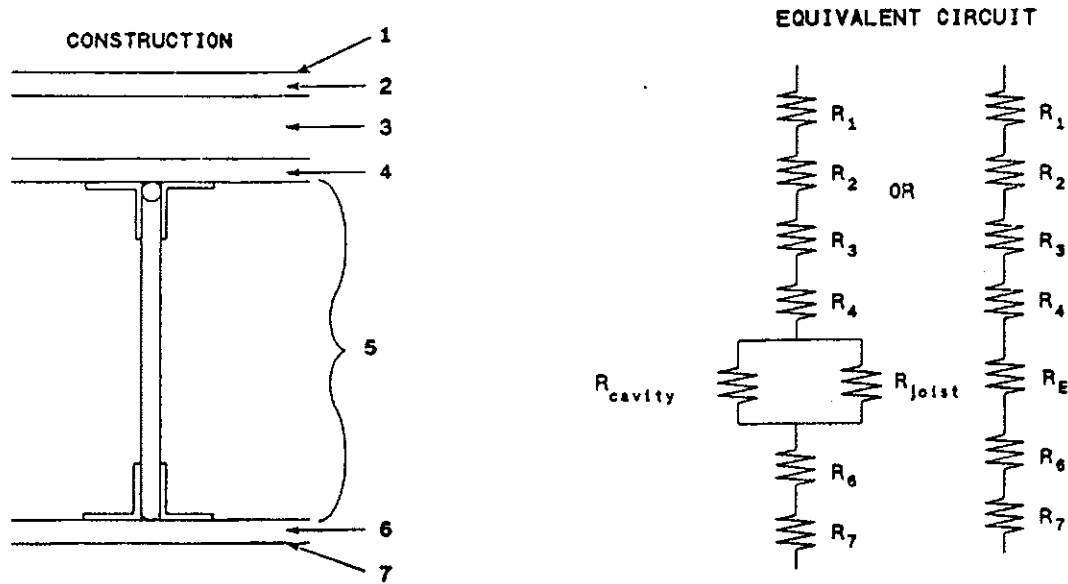
(2) THERMAL TRANSMITTANCE (U_1) OF AN INDIVIDUAL PATH THROUGH AN ENVELOPE ASSEMBLY. The thermal transmittance of each envelope shall be determined with consideration of all major series and parallel heat flow paths through the elements of the assembly and film coefficients. Compression of insulation shall be considered in determining the thermal resistance.

(a) Thermal transmittance of opaque elements. The thermal transmittance of opaque elements of assemblies shall be determined using a series path procedure with correction for the presence of parallel paths within an element of the envelope assembly such as wall cavities with parallel paths through insulation and studs. An acceptable procedure shall be used, as specified in Figure 63.18-1. Figure 63.18-2 illustrates a typical roof assembly.

Figure 63.18-1 Calculation Procedures for Evaluating Major Series and Parallel Heat Flow Paths

Acceptable Procedures for Determining U_1 for Opaque Elements		
Sheathing	Framing	
	Metal	Nonmetal
Metal on One or Both Sides	Tests – s. Comm 63.18 (2)(a) 1.a. Thermal Bridges – s. Comm 63.18 (2)(a) 1.c.	Tests – s. Comm 63.18 (2)(a) 1.a. Series or Parallel Path – s. Comm 63.18 (2)(a) 2.
Nonmetal on Both Sides	Tests – s. Comm 63.18 (2)(a) 1.a. Parallel Path Correction Factor – s. Comm 63.18 (2)(a) 1.b. Zone Method – s. Comm 63.18 (2)(a) 1.d.	Tests – s. Comm 63.18 (2)(a) 1.a. Series or Parallel Path – s. Comm 63.18 (2)(a) 2.

Figure 63.18-2 Calculation Procedure for Thermal Resistance of a Typical Roof Assembly



$$\text{Where } 1/R_e = \frac{(1 - \% \text{ joist})}{R_{\text{cavity}}} + \frac{\% \text{ Joist}}{R_{\text{joist}}} \text{ or } R_e = R_{\text{cavity}} \times F_c$$

R_e is the equivalent resistance of the element contacting the parallel path. F_c is the parallel path correction factor.

1. For envelope assemblies containing metal framing, the U_i shall be determined by using one of the following methods:

- a. Results from laboratory or field test measurements. One of the procedures specified in s. Comm 63.17 shall be used.
- b. The thermal resistance of those roof and wall assemblies listed in Tables 63.18-1 and 63.18-2 shall be corrected using the following parallel path correction factor procedure:

Considering the total resistance of the series path:

$$U_i = 1/R_t$$

$$R_t = R_i + R_e$$

where:

R_t = The total resistance of the envelope assembly.

R_i = The resistance of the series elements (for $i = 1$ to n) excluding the parallel path element(s)

R_e = The equivalent resistance of the element containing the parallel path, the value of R_e is:

$$R_e = R - \text{value of insulation} \times F_c$$

The Parallel Path Correction Factors (F_c) may be obtained from tests conducted using procedures listed in s. Comm 63.17. Parallel Path Correction Factors for some envelope assemblies are listed in Tables 63.18-1 and 63.18-2.

c. For elements with internal metallic structures bonded on one or both sides to a metal skin or covering, the calculation procedure specified in the ASHRAE Handbook, Fundamentals Volume, or specified in ASHRAE 90.1, or other procedure acceptable to the department shall be used to include the effects of thermal bridges in metal construction.

d. For elements other than those covered above, the zone method described in the ASHRAE Handbook, Fundamentals Volume shall be used for calculation.

Table 63.18-1
Roofs
Parallel Path Correction Factors^a

Bridged R-Value	0	5	10	15	20	25	30	35	40	45	50	55
Correction Factor	1.0	0.96	0.92	0.88	0.85	0.81	0.79	0.76	0.73	0.71	0.69	0.67

^a Table values are based upon metal trusses with 4-foot spacing that penetrate the insulation, and 0.66-inch diameter cross members every 1 foot.

Table 63.18-2
Wall Sections With Metal Studs
Parallel Path Correction Factors

Size of Members	Gauge of Stud ^a	Spacing of Framing, in.	Cavity Insulation R-Value	Correction Factor	Effective Framing/Cavity R-Values
2 x 4	18-16	16 o.c.	R-11	0.50	R-5.5
			R-13	0.46	R-6.0
			R-15	0.43	R-6.4
2 x 4	18-16	24 o.c.	R-11	0.60	R-6.6
			R-13	0.55	R-7.2
			R-15	0.52	R-7.8
2 x 6	18-16	16 o.c.	R-19	0.37	R-7.1
			R-21	0.35	R-7.4
2 x 6	18-16	24 o.c.	R-19	0.45	R-8.6
			R-21	0.43	R-9.0
2 x 8	18-16	16 o.c.	R-25	0.31	R-7.8
2 x 8	18-16	24 o.c.	R-25	0.38	R-9.6

^a These factors can be applied to metal studs of this gauge or thinner.

2. For assemblies containing nonmetal framing, the U_i shall be determined from one of the laboratory or field test measurements specified in s. Comm 63.17 or from the ASHRAE series-parallel method. Formulas in the ASHRAE Handbook, Fundamentals Volume, shall be used for these calculations.

3. The opaque portions of doors shall be considered to be a part of the opaque wall assembly in the calculation of the average thermal transmittance. The thermal transmittance of the entire opaque door assembly including the frame shall be included in the calculation.

Note: See Appendix A for sample U-values for doors and explanatory information.

Note: See s. Comm 51.06 for thermal barrier requirements for foam plastics.

(b) *Thermal transmittance of fenestration.* Values of U_{of} shall be determined using one of the following methods:

1. The National Fenestration Rating Council (NFRC) 100 Procedure for Determining Fenestration Product Thermal Properties. The thermal performance values shall be certified through the NFRC Fenestration Thermal Performance Rating Certification and Labeling Program as described in the NFRC Product Certification Program LAP 1, PCP 1, and CAP 1.

2. The values for the appropriate product type given in Table 63.18-3 may be used.

Note: Interpolation between tables for glazing other than 0°, 45° and 90° is acceptable.

Note: In order to use the component standards option of s. Comm 63.15, the U -value of fenestration must be 0.52 or less.

Table 63.18-3, Part I
Window U-Values

Glazing Type	Aluminum Frame— no thermal break*	Aluminum Frame— thermal break*	Wood or Vinyl Frame
Single glazing			
Glass	1.23	1.10	0.98
1/8 in. acrylic	1.16	1.03	0.92
Double glass, air filled			
1/4 in. air space	0.78	0.65	0.55
3/8 in. air space	0.74	0.60	0.51
1/2 in. and greater	0.72	0.59	0.49
Double glass, low emissivity = 0.4 on surface 2 or 3			
1/4 in. air space	0.73	0.59	0.50
3/8 in. air space	0.67	0.54	0.45
1/2 in. and greater	0.65	0.52	0.42
Double glass, low emissivity = 0.15 on surface 2 or 3			
1/4 in. air space	0.68	0.55	0.46
3/8 in. air space	0.62	0.48	0.39
1/2 in. and greater	0.60	0.46	0.37
Double glass, argon filled			
1/4 in. argon space	0.74	0.61	0.51
3/8 in. argon space	0.71	0.57	0.48
1/2 in. and greater	0.69	0.56	0.47
Double glass, low emissivity = 0.4 on surface 2 or 3, argon filled			
1/4 in. argon space	0.67	0.54	0.45
3/8 in. argon space	0.63	0.49	0.40
1/2 in. and greater	0.62	0.48	0.39
Double glass, low emissivity = 0.15 on surface 2 or 3, argon filled			
1/4 in. argon space	0.62	0.48	0.39
3/8 in. argon space	0.57	0.43	0.34
1/2 in. and greater	0.55	0.42	0.33
Double glazing, 1/8 in. acrylic or polycarbonate			
1/4 in. air space	0.74	0.61	0.51
3/8 in. air space	0.71	0.57	0.48
1/2 in. and greater	0.69	0.56	0.47
Double glazing, 1/4 in. acrylic or polycarbonate			
1/4 in. air space	0.71	0.57	0.48
3/8 in. air space	0.68	0.54	0.45
1/2 in. and greater	0.66	0.53	0.43
Triple glass			
1/4 in. air space	0.64	0.50	0.41
3/8 in. air space	0.60	0.46	0.38
1/2 in. and greater	0.58	0.45	0.36
Triple glass or double glass with polyester film suspended in between, low emissivity = 0.15 on surface 2, 3, 4, or 5			
1/4 in. air space	0.59	0.45	0.37
3/8 in. air space	0.54	0.41	0.32
1/2 in. and greater	0.52	0.39	0.30
Triple glass, argon filled			
1/4 in. argon space	0.60	0.46	0.38
3/8 in. argon space	0.57	0.44	0.35
1/2 in. and greater	0.56	0.42	0.34
Triple glass or double glass with polyester film suspended in between, low emissivity = 0.15 on surface 2, 3, 4, or 5			
1/4 in. argon space	0.54	0.41	0.32
3/8 in. argon space	0.51	0.37	0.29
1/2 in. and greater	0.50	0.36	0.28

Table 63.18-3, Part II
Skylight U-Values - 45 Degree Slope

Glazing Type	Aluminum Frame— no thermal break*	Aluminum Frame— thermal break*	Wood or Vinyl Frame
Single glazing			
Glass	1.36	1.22	1.09
1/8 in. acrylic	1.29	1.14	1.02
Double glass, air filled			
1/4 in. air space	0.88	0.74	0.63
3/8 in. air space	0.83	0.68	0.58
1/2 in. and greater	0.81	0.67	0.56
Double glass, low emissivity = 0.4 on surface 2 or 3			
1/4 in. air space	0.82	0.67	0.57
3/8 in. air space	0.76	0.61	0.52
1/2 in. and greater	0.74	0.59	0.49
Double glass, low emissivity = 0.15 on surface 2 or 3			
1/4 in. air space	0.77	0.63	0.53
3/8 in. air space	0.70	0.55	0.46
1/2 in. and greater	0.68	0.53	0.44
Double glass, argon filled			
1/4 in. argon space	0.83	0.69	0.58
3/8 in. argon space	0.80	0.65	0.55
1/2 in. and greater	0.78	0.64	0.54
Double glass, low emissivity = 0.4 on surface 2 or 3, argon filled			
1/4 in. argon space	0.76	0.61	0.52
3/8 in. argon space	0.71	0.56	0.47
1/2 in. and greater	0.70	0.55	0.46
Double glass, low emissivity = 0.15 on surface 2 or 3, argon filled			
1/4 in. argon space	0.70	0.55	0.46
3/8 in. argon space	0.65	0.50	0.40
1/2 in. and greater	0.63	0.49	0.39
Double glazing, 1/8 in. acrylic or polycarbonate			
1/4 in. air space	0.83	0.69	0.58
3/8 in. air space	0.80	0.65	0.55
1/2 in. and greater	0.78	0.64	0.54
Double glazing, 1/4 in. acrylic or polycarbonate			
1/4 in. air space	0.80	0.65	0.55
3/8 in. air space	0.77	0.61	0.52
1/2 in. and greater	0.75	0.60	0.50
Triple glass			
1/4 in. air space	0.72	0.57	0.48
3/8 in. air space	0.68	0.53	0.45
1/2 in. and greater	0.66	0.52	0.43
Triple glass or double glass with polyester film suspended in between, low emissivity = 0.15 on surface 2, 3, 4, or 5			
1/4 in. air space	0.67	0.52	0.44
3/8 in. air space	0.61	0.48	0.38
1/2 in. and greater	0.59	0.46	0.36
Triple glass, argon filled			
1/4 in. argon space	0.68	0.53	0.45
3/8 in. argon space	0.65	0.51	0.42
1/2 in. and greater	0.64	0.49	0.40
Triple glass or double glass with polyester film suspended in between, low emissivity = 0.15 on surface 2, 3, 4, or 5			
1/4 in. argon space	0.61	0.48	0.38
3/8 in. argon space	0.58	0.44	0.35
1/2 in. and greater	0.57	0.43	0.34

Table 63.18-3, Part III
Skylight U-Values - Horizontal

Glazing Type	Aluminum Frame— no thermal break*	Aluminum Frame— thermal break*	Wood or Vinyl Frame
Single glazing			
Glass	1.38	1.25	1.12
1/8 in. acrylic	1.31	1.17	1.06
Double glass, air filled			
1/4 in. air space	0.91	0.77	0.67
3/8 in. air space	0.86	0.72	0.62
1/2 in. and greater	0.84	0.71	0.60
Double glass, low emissivity = 0.4 on surface 2 or 3			
1/4 in. air space	0.85	0.71	0.61
3/8 in. air space	0.79	0.65	0.56
1/2 in. and greater	0.77	0.63	0.53
Double glass, low emissivity = 0.15 on surface 2 or 3			
1/4 in. air space	0.80	0.67	0.57
3/8 in. air space	0.74	0.59	0.50
1/2 in. and greater	0.72	0.57	0.48
Double glass, argon filled			
1/4 in. argon space	0.86	0.73	0.62
3/8 in. argon space	0.83	0.69	0.59
1/2 in. and greater	0.81	0.68	0.58
Double glass, low emissivity = 0.4 on surface 2 or 3, argon filled			
1/4 in. argon space	0.79	0.65	0.56
3/8 in. argon space	0.75	0.60	0.51
1/2 in. and greater	0.74	0.59	0.50
Double glass, low emissivity = 0.15 on surface 2 or 3, argon filled			
1/4 in. argon space	0.74	0.59	0.50
3/8 in. argon space	0.69	0.54	0.44
1/2 in. and greater	0.67	0.53	0.43
Double glazing, 1/8 in. acrylic or polycarbonate			
1/4 in. air space	0.86	0.73	0.62
3/8 in. air space	0.83	0.69	0.59
1/2 in. and greater	0.81	0.68	0.58
Double glazing, 1/4 in. acrylic or polycarbonate			
1/4 in. air space	0.83	0.69	0.59
3/8 in. air space	0.80	0.65	0.56
1/2 in. and greater	0.78	0.64	0.54
Triple glass			
1/4 in. air space	0.76	0.61	0.52
3/8 in. air space	0.72	0.57	0.49
1/2 in. and greater	0.70	0.56	0.47
Triple glass or double glass with polyester film suspended in between, low emissivity = 0.15 on surface 2, 3, 4, or 5			
1/4 in. air space	0.71	0.56	0.48
3/8 in. air space	0.65	0.52	0.42
1/2 in. and greater	0.63	0.50	0.40
Triple glass, argon filled			
1/4 in. argon space	0.72	0.57	0.49
3/8 in. argon space	0.69	0.55	0.46
1/2 in. and greater	0.68	0.53	0.44
Triple glass or double glass with polyester film suspended in between, low emissivity = 0.15 on surface 2, 3, 4, or 5			
1/4 in. argon space	0.65	0.52	0.42
3/8 in. argon space	0.62	0.48	0.39
1/2 in. and greater	0.61	0.47	0.38

* **Note to Table 63.18-3:** An aluminum thermal break framed window shall incorporate the following minimum design characteristics:

- a. The thermal conductivity of the thermal break material shall be not more than 3.6 Btu-in/hr/ft²/F°;
- b. The thermal break material shall not be less than 0.210 inches; and
- c. All metal framing members of the product to interior and exterior air must incorporate a thermal break meeting the criteria in a. and b. above.

(3) GROSS AREA OF ENVELOPE COMPONENTS. (a) *Roof assembly.* The gross area of a roof assembly consists of the total surface of the roof assembly exposed to outside air or unconditioned spaces. The roof assembly shall be considered to include all roof or ceiling components through which heat may flow between indoor and outdoor environments including skylight surfaces but excluding service openings. For thermal transmittance purposes when return air ceiling plenums are employed, the roof or ceiling assembly shall not include the resistance of the ceiling or the plenum space as part of the total resistance of the assembly.

(b) *Floor assembly.* The gross area of a floor assembly over outside or unconditioned spaces consists of the total surface of the floor assembly exposed to outside air or unconditioned space. The floor assembly shall include all floor components through which heat may flow between indoor and outdoor or unconditioned space environments.

(c) *Exterior walls.* The gross area of exterior walls enclosing a heated or cooled space is measured on the exterior and consists of the opaque wall including between floor spandrels, peripheral edges of flooring, window areas including sash, and door areas, but excluding vents, grilles, and pipes.

(4) SHADING COEFFICIENTS. The Shading Coefficient (SC_x) for fenestration shall be obtained from the ASHRAE Handbook, Fundamentals Volume or from manufacturer's test data. SC_x is the Shading Coefficient of the fenestration including permanently installed internal and external shading devices but excluding the effect of external shading projections, which is calculated separately. The Shading Coefficient used for louvered shade screens shall be determined using a profile angle of 30° as found in the ASHRAE Handbook, Fundamentals Volume.

Note: Manufacturers should be able to provide shading coefficients for their products

History: Cr. Register, March, 1997, No. 495, eff. 4-1-97.

Comm 63.19 Prohibition of heated sidewalks. The installation or use of heated sidewalks is prohibited as specified in s. 101.124, Stats.

Note: Section 101.124, Stats., reads as follows:

101.124 Heated Sidewalks Prohibited. In this section "exterior pedestrian traffic surface" means any sidewalk, ramp, stair, stoop, step, entrance way, plaza or pedestrian bridge not fully enclosed within a building and "heated" means heated by electricity or energy derived from the combustion of fossil fuels, but not including the use of waste thermal energy. "Exterior pedestrian traffic surface" does not include any means of ingress or egress by the physically disabled required under s. 101.13 (2). No person may construct a heated exterior pedestrian traffic surface. The department or any city, village, town or county is prohibited from approving any plan under s. 101.12 which includes such heated surface. The department shall order any existing heated exterior pedestrian traffic surface in operation to be shut off. This section does not apply to any inpatient health care facility as defined in s. 50.135 (1), or community-based residential facility, as defined in s. 50.01 (1g).

History: Cr. Register, March, 1997, No. 495, eff. 4-1-97.

Subchapter IV Equipment And Systems

Part 1 – Equipment Efficiencies

Comm 63.20 Minimum equipment efficiencies.

(1) Space heating or cooling equipment that is not covered by 10 CFR Part 430, Energy Conservation Program for Consumer Products, shall have a minimum efficiency at the specified rating conditions not less than the values given in ASHRAE 90.1, section 10.4.1.

Note: Equipment that is covered by the federal regulation 10 cfr Part 430 is not included under the scope of this code. Efficiencies required by that standard are reprinted in Appendix A. Efficiencies required by ASHRAE 90.1-1989 are also printed in Appendix A.

(2) Equipment ratings shall be certified under a nationally recognized certification program or rating procedure or data furnished

by the equipment manufacturer to show compliance with the minimum efficiency requirements.

Note: The following certification programs are accepted by the department: GAMMA and ARI.

(3) Compliance with minimum efficiency requirements specified for HVAC equipment shall include compliance with part-load requirements where indicated as well as standards for full-load requirements. The part-load efficiency shall be determined as specified in the ARI standards specified in ASHRAE 90.1.

(4) Space heating or cooling equipment used to provide additional functions such as water heating for plumbing, as part of a combination or integrated system shall comply with minimum performance requirements for the appropriate space heating or cooling equipment category.

(5) Equipment providing water heating for plumbing that is used to provide additional functions, such as space heating, as part of a combination or integrated system shall comply with minimum performance requirements for water heating equipment as specified in s. Comm 84.20 (5) (n).

(6) Combination space and plumbing water heating equipment may only be used when at least one of the following conditions is met:

(a) The annual space heating energy is less than 50% of the annual water heating energy for plumbing.

(b) The energy input or storage volume of the combined boiler or water heater is less than twice the energy input or storage volume of the smaller of the separate boilers or water heaters otherwise required.

(c) The combined system uses no more energy than separate systems that meet the requirements of this section.

(d) The input to the combined boiler or water heater system is less than 150,000 Btu/h.

Note: See s. Comm 64.22 (10) for additional requirements for combined systems.

(7) Equipment that is not used for comfort cooling or comfort heating is exempt from the energy efficiency requirements of this chapter.

Note: Omission of minimum performance requirements for certain classes of HVAC equipment does not preclude use of that equipment.

History: Cr. Register, March, 1997, No. 495, eff. 4-1-97.

Comm 63.21 Field-assembled equipment and components. When components such as indoor or outdoor coils are used from more than one manufacturer as parts of air-conditioning or heating equipment, component efficiencies shall be specified based on data provided by the component manufacturers.

History: Cr. Register, March, 1997, No. 495, eff. 4-1-97.

Comm 63.22 Equipment controls. **(1)** Heat pumps equipped with supplementary heaters shall be installed with controls to prevent heater operation when the heating load can be met by the heat pump, except under the conditions listed below:

(a) Where it can be shown that supplementary heating reduces energy consumption.

(b) Supplementary heater operation is permitted during short transient periods of less than 15 minutes during defrost cycles.

(2) The setback recovery and tempering of indoor air during defrost cycles shall be controlled so as to minimize use of supplemental heat.

History: Cr. Register, March, 1997, No. 495, eff. 4-1-97.

Part 2 – System Design

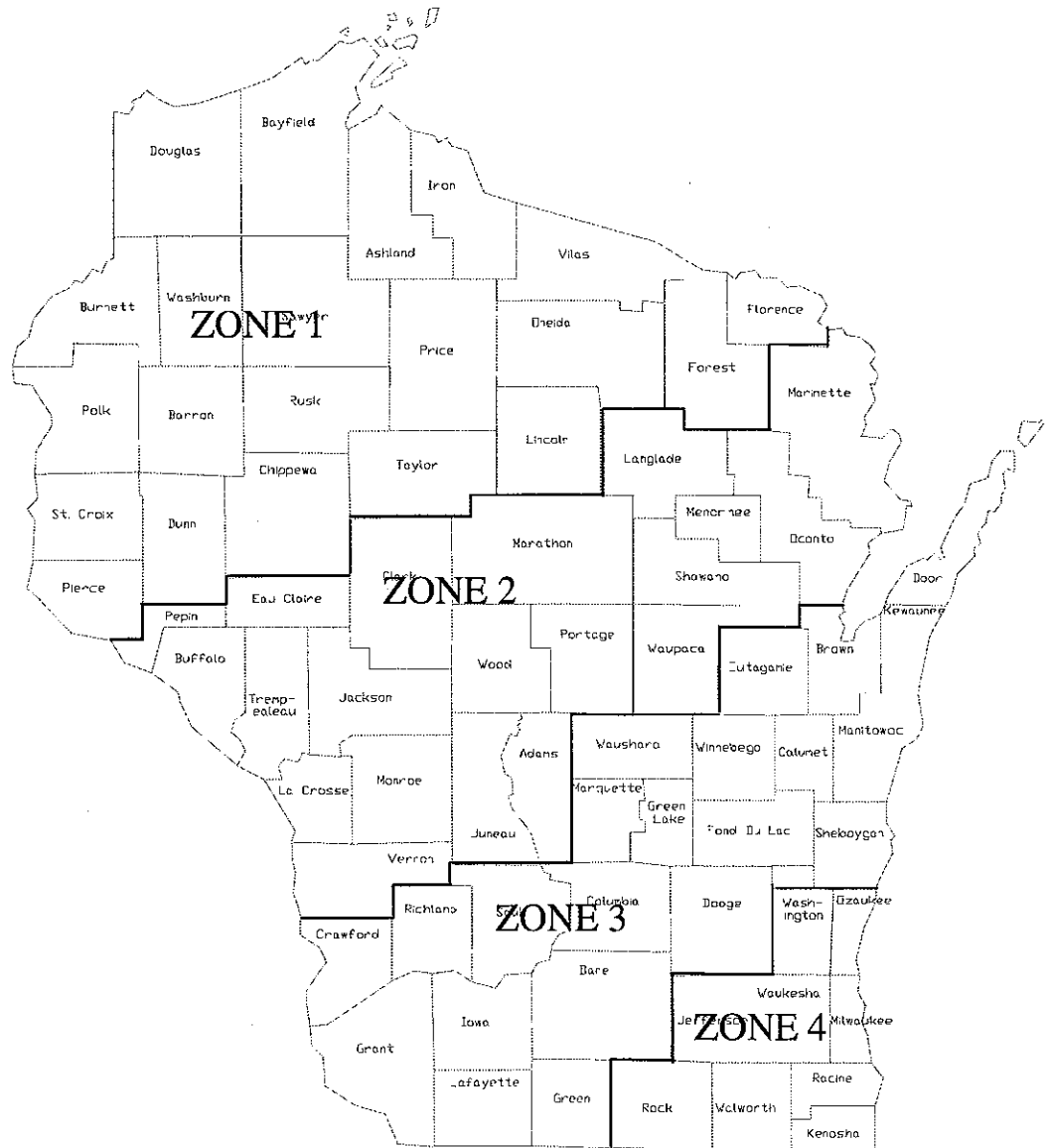
Comm 63.23 Load calculations for sizing. **(1)** CALCULATION PROCEDURES. Heating and cooling system design loads for the purpose of sizing systems and equipment shall be determined in accordance with the procedures described in the ASHRAE Handbook, Fundamentals Volume, or a similar computation procedure approved by the department. For those design parameters addressed in subs (2) to (7), the values specified shall be used.

Note: This section does not require the installation of cooling equipment.

(2) INDOOR DESIGN CONDITIONS. The winter indoor design temperature is specified in Table 64.05. When air conditioning is provided in accordance with s. Comm 64.06 (2)(b), the summer indoor design temperature is 78°F or lower.

(3) OUTDOOR DESIGN CONDITIONS. Outdoor design temperatures shall be taken from Figure 63.23.

Figure 63.23
Outdoor Design Conditions



Zone	Winter	Summer	
	Design Temp. (°F)	Dry Bulb (°F)	Wet Bulb (°F)
1	-25	86	75*
2	-20	87	75
3	-15	87	75
4	-10	89	77

*Exception: For Douglas, Bayfield, Ashland and Iron Counties, use 70°F summer wet bulb design temperature.

(4) **VENTILATION.** Outdoor air ventilation loads shall be based on ventilation rates specified in s. Comm 64.05.

(5) **ENVELOPE.** Envelope heating and cooling loads shall be based on envelope characteristics such as thermal conductance, shading coefficient, and air leakage consistent with the values used to demonstrate compliance with subch. III.

(6) **LIGHTING.** Lighting loads shall be based on actual design lighting levels or power budgets consistent with subch. V. Lighting loads may not be included for the purpose of calculating design heating loads.

(7) **PICK-UP LOADS.** Transient loads such as warm-up or cool-down loads which occur after off-hour setback or shutoff may be calculated from principles based on the heat capacity of the building and its contents, the degree of setback, and desired recovery time; or may be assumed to be up to 30% for heating and 10% for cooling of the steady-state design loads.

History: Cr. Register, March, 1997, No. 495, eff. 4-1-97.

Comm 63.24 System and equipment sizing. HVAC systems and equipment shall be sized to provide the minimum space and system loads calculated in accordance with s. Comm 63.23.

History: Cr. Register, March, 1997, No. 495, eff. 4-1-97.

Comm 63.25 Separate air distribution systems.

(1) Except as provided in sub. (2), zones with special process temperature requirements, humidity requirements, or both, shall be served by air distribution system separate from those serving zones requiring only comfort conditions; or shall include supplementary provisions so that the primary systems may be specifically controlled for comfort purposes only.

(2) As an exception to sub. (1), zones requiring only comfort heating or comfort cooling that are served by a system primarily used for process temperature and humidity control need not be served by a separate system if the total supply air to these comfort zones is no more than 25% of the total system supply air or the total conditioned floor area of the zones is less than 1,000 square feet.

History: Cr. Register, March, 1997, No. 495, eff. 4-1-97.

Comm 63.26 Temperature controls. (1) SYSTEM CONTROL. Each HVAC system shall include at least one temperature control device.

(2) **ZONE CONTROLS.** (a) 1. Except as provided in subd. 2., the supply of heating and cooling energy to each zone shall be controlled by individual thermostatic controls responding to temperature within the zone.

2. Independent perimeter systems that are designed to offset only envelope heat losses or gains or both may serve one or more zones also served by an interior system with the following limitations:

a. The perimeter system shall include at least one thermostatic control zone for each building exposure having exterior walls facing only one orientation for 50 contiguous feet or more; and

b. The perimeter system heating and cooling supply shall be controlled by thermostats located within the zones served by the system.

(b) Where used to control comfort heating, zone thermostatic controls shall be capable of being set locally or remotely by adjustment or selection of sensors down to 55°F or lower.

(c) Where used to control comfort cooling, zone thermostatic controls shall be capable of being set locally or remotely by adjustment or selection of sensors up to 85°F or higher.

(d) Except as provided in subds. 1. to 3., zone thermostatic controls used to control both comfort heating and cooling shall be capable of providing a temperature range, or deadband, of at least 5°F within which the supply of heating and cooling energy to the zone is shut off or reduced to a minimum.

1. Deadbands are not required for special occupancy, special usage, or code-required systems where deadband controls are not appropriate.

2. Deadbands are not required for buildings complying with the ASHRAE energy cost budget method under Subchapter VII if, in the proposed building energy analysis, heating and cooling thermostat set-points are set to the same value between 70°F and 75°F inclusive and assumed to be constant throughout the year.

3. Deadbands may be omitted for thermostats that have manual changeover between heating and cooling modes.

History: Cr. Register, March, 1997, No. 495, eff. 4-1-97.

Comm 63.27 Zone controls. (1) Except as provided in sub. (2), zone thermostatic and humidistatic controls shall be capable of operating in sequence to supply heating and cooling energy to the zone. Such controls shall prevent:

(a) Reheating;

(b) Recooling;

(c) Mixing or simultaneous supply of air that has been previously mechanically heated and air that has been previously cooled, either by mechanical refrigeration or by economizer systems; or

(d) Other simultaneous operation of heating and cooling systems to the same zone.

(2) The following systems and zones are exempt from this section:

(a) Variable air volume (VAV) systems which, during periods of occupancy, are designed to reduce the air supply to each zone to a minimum before reheating, recooling, or mixing takes place. This minimum volume shall be no greater than the largest of the following:

1. 30% of the peak supply volume;

2. The minimum required to meet ventilation requirements of s. Comm 64.05;

3. 0.4 cfm/square foot of zone conditioned floor area.

(b) Zones where special pressurization relationships or cross-contamination requirements are such that the cost of controls for variable air volume systems exceeds the value of the energy saved, such as some areas of hospitals and laboratories;

(c) Where at least 75% of the energy for reheating or for providing warm air in mixing systems is provided from a site-recovered or site-solar energy source.

(d) Zones where specified humidity levels are required to satisfy process needs, such as computer rooms and museums; and

(e) Zones with a peak supply air quantity of 150 cfm or less.

(f) Multiple reheat systems serving multiple zones, other than those employing variable air volume for temperature control, that are provided with controls that will automatically reset the system cold air supply to the highest temperature level that will satisfy the zone requiring the coolest air.

(g) Dual duct and multizone systems that are provided with controls that will automatically reset:

1. The cold duct air supply to the highest temperature that will satisfy the zone requiring the coolest air; and

2. The hot duct air supply to the lowest temperature that will satisfy the zone requiring the warmest air.

(h) Systems in which heated air is recooled, directly or indirectly, to maintain space temperature that are provided with controls that will automatically reset the temperature to which the supply air is heated to the lowest level that will satisfy the zone requiring the warmest air.

(i) A multiple zone heating, ventilating and air-conditioning system that employs reheating or recooling for control of not more than 5,000 cfm or 20% of the total supply air of the system, whichever is less.

(3) **OFF-HOUR CONTROLS.** Except as provided in pars. (a) to (c), mechanical HVAC systems shall be equipped with automatic

controls capable of accomplishing a reduction of energy use through control setback or equipment shutdown during periods of nonuse or alternate use of the zones served by the system. The following systems are exempt from this subsection:

- (a) Systems serving areas expected to operate continuously;
- (b) Where it can be shown that setback or shutdown will not result in a decrease in overall building energy costs; or
- (c) Equipment with full load demands of 2 kW or 6826 Btu/h or less may be controlled by readily accessible manual off-hour controls.

History: Cr. Register, March, 1997, No. 495, eff. 4-1-97.

Comm 63.28 Humidity control. If a system is equipped with a means for adding moisture to maintain specific humidity levels in a zone or zones, a humidistat shall be provided.

History: Cr. Register, March, 1997, No. 495, eff. 4-1-97.

Comm 63.29 Insulation, materials and construction. (1) GENERAL. Insulation required by subs. (2) and (3) shall be suitably protected from damage.

Note: Insulation should be installed in accordance with practices acceptable to the department such as MICA Commercial and Industrial Insulation Standards.

(2) PIPING INSULATION. Except as provided in pars. (a) to (c), recirculating plumbing system piping, plumbing piping in the first 8 feet from storage tanks for noncirculating systems, any piping served by a self-regulating electric heating cable, HVAC system piping, and related HVAC fluid conveying conduit, such as heat exchanger bodies, shall be thermally insulated in accordance with Table 63.29-1 or equivalent. The following piping or conduit is exempted from this subsection:

(a) Factory-installed piping or conduit within HVAC equipment tested and rated in accordance with s. Comm 63.20;

(b) Piping or conduit for which no insulation is specified in Table 63.29-1.

(c) Where it can be shown that the heat gain or heat loss to or from piping or conduit without insulation will not increase building energy use.

Note: For equivalent insulation levels using alternative insulation types, the calculation procedure specified in A63.29 of Appendix A is acceptable to the department.

**Table 63.29-1
Plumbing and HVAC Piping Minimum Insulation (in.)^{a,b}**

Fluid Operating Temperature Range, °F	Nominal Pipe Diameter (in.)					Insulation Conductivity	
	1 and Less	1-1/4 to 2	2 1/2 to 4	5 and 6	8 and up	Conductivity Range Btu•in./(h•ft ² •F)	Mean Rating Temperature °F
Hot Systems (Steam, Steam Condensate, and Hot Water)							
Above 350	2.5	2.5	3.0	3.5	3.5	0.32 - 0.34	250
251 - 350	2.0	2.5	2.5	3.5	3.5	0.29 - 0.31	200
201 - 250	1.5	1.5	2.0	2.0	3.5	0.27 - 0.30	150
141 - 200	1.5	1.5	1.5	1.5	1.5	0.25 - 0.29	125
105 - 140	1.0	1.0	1.0	1.5	1.5	0.24 - 0.28	100
80 - 104	0.5	0.5	0.5	1.0	1.0	0.24 - 0.28	100
Cold Systems (Chilled Water, Brine, and Refrigerant) ^c							
40 - 55	0.5	0.75	1.0	1.0	1.0	0.23 - 0.27	75
Below 40	1.0	1.5	1.5	1.5	1.5	0.23 - 0.27	75

^a For minimum thicknesses of alternative insulation types, see Appendix A.

^b Plumbing piping systems without a heat trap to prevent circulation due to natural convection shall be considered circulating systems.

^c The required minimum thicknesses do not consider water vapor transmission and condensation. Additional insulation, vapor retarders, or both, may be required to limit water vapor transmission and condensation.

(3) AIR-HANDLING SYSTEM INSULATION. All air-handling ducts and plenums installed as part of an HVAC air distribution system shall be thermally insulated in accordance with Table 63.29-2, except where it can be shown that the heat gain to or heat loss from ducts without insulation will not increase building energy use.

**Table 63.29-2
Minimum Duct Insulation^a**

Duct Location	Cooling ^b Insulation R-Value ^d (hrft ² F)/Btu	Heating ^c Insulation R-Value ^d (hrft ² F)/Btu
Exterior of Building	5.0	9.0
Interior ^g Td ^e ≤ 15 40 ≥ Td ^e > 15 Td ^e > 40	None Required 3.3 5.0 ^f	None Required 3.3 5.0 ^f

^a Insulation R-values shown are for the insulation as installed and do not include film resistance. The required minimum thicknesses do not consider water vapor transmission and condensation. Additional insulation, vapor retarders, or both, may be required to limit vapor transmission and condensation. For ducts which are designed to convey both heated and cooled air, duct insulation shall be as required by the most restrictive condition. Where exterior walls are used as plenum walls, wall insulation shall be as required by the most restrictive condition of this section or Subchapter III.

^b Cooling ducts are those designed to convey cooled air or return ducts in such systems.

^c Heating ducts are those designed to convey heated air or return ducts in such systems.

^d Insulation resistance measured on a horizontal plane in accordance with ASTM C518 at a mean temperature of 75°F at the installed thickness.

^e Td is defined as the temperature difference at design conditions (see s. Comm 63.25) between the space within which the duct is located and the design air temperature in the duct.

^f Insulation resistance for runouts to terminal devices less than 10 feet in length need not exceed 3.3 (h ft² °F)/Btu.

^g Interior ducts include any ducts inside the building thermal envelope. Exterior ducts include ducts in unconditioned spaces such as crawlspaces and attics.

History: Cr. Register, March, 1997, No. 495, eff. 4-1-97.

Comm 63.31 Economizer controls. (1) Except as provided in sub. (2), each fan system shall be designed and capable of being controlled to take advantage of favorable weather conditions to reduce mechanical cooling requirements. The system shall include either of the following:

(a) A temperature or enthalpy air economizer system which is capable of automatically modulating outside air and return air dampers to provide 100% of the design supply air quantity as outside air for cooling;

(b) A water economizer system which is capable of cooling supply air by direct evaporation, indirect evaporation, or both. Such a system shall be designed and capable of being controlled to provide 100% of the expected system cooling load at outside air temperatures of 50°F dry-bulb/45°F wet-bulb and below.

(2) The following systems are exempt from this subsection:

(a) Individual fan-cooling units with a supply capacity of less than 2,000 cfm or a total system cooling capacity of less than 62,000 Btu/hour for split systems or less than 55,000 Btu/hour for all other types. The total capacity of all such units complying by use of this exception shall not exceed 600,000 Btu/hour per building or 10% of the total installed cooling capacity, whichever is larger;

(b) Systems with air or evaporatively cooled condensers for which it can be shown that the use of outdoor air cooling affects the operation of other systems, such as humidification, dehumidification, or supermarket refrigeration systems, so as to increase overall building energy costs;

Note: Other areas that may use controlled humidification or dehumidification are computer rooms, museums, library stacks and drafting rooms.

(c) Where the overall building energy use resulting from alternative designs, such as internal to external zone heat recovery systems, can be shown to be less than those resulting from an economizer system.

History: Cr. Register, March, 1997, No. 495, eff. 4-1-97.

Comm 63.32 Electrical motors. (1) Any permanently wired motor that meets all of the criteria specified in pars. (a) through (g) shall meet the efficiency requirements specified in Table 63.32 and the requirements of this section.

(a) The motor is used in a HVAC fan or pumping system;

(b) The motor is polyphase;

(c) The motor is one horsepower or more;

(d) The motor is a design A or B squirrel-cage, foot-mounted, T-frame induction motor that has synchronous speeds of 3600, 1800, 1200, and 900 rpm;

(e) The motor is expected to operate more than 1000 hours per year;

(f) The motor is not a multispeed motor used in a system designed to use more than one speed; and

(g) The motor is not a component of equipment that meets the efficiency requirements of s. Comm 63.20 and the motor input is included in the determination of the equipment efficiency.

(2) The motor nameplate shall list the minimum nominal full-load motor efficiency.

Note: Motors that are classified as "energy efficient" under the National Electric Manufacturer's Association Standard MG 12.55, dated 3-14-91, are acceptable to the department as meeting the efficiency requirements of this section.

History: Cr. Register, March, 1997, No. 495, eff. 4-1-97.

Table 63.32
Minimum Acceptable Nominal Full-Load Motor Efficiency For Single-Speed Polyphase Squirrel-Cage Induction Motors Having Synchronous Speeds of 3600, 1800, 1200 and 990 rpm

Full-Load Efficiencies – Open Motors								
HP	2-Pole		4-Pole		6-Pole		8-Pole	
	Nominal Efficiency	Minimum Efficiency	Nominal Efficiency	Minimum Efficiency	Nominal Efficiency	Minimum Efficiency	Nominal Efficiency	Minimum Efficiency
1.0	—	—	82.5	81.5	80.0	78.5	74.0	72.0
1.5	82.5	81.5	84.0	82.5	84.0	82.5	75.5	74.0
2.0	84.0	82.5	84.0	82.5	85.5	84.0	85.5	84.0
3.0	84.0	82.5	86.5	85.5	86.5	85.5	86.5	85.5
5.0	85.5	84.0	87.5	86.5	87.5	86.5	87.5	86.0
7.5	87.5	86.5	88.5	87.5	88.5	87.5	88.5	87.5
10.0	88.5	87.5	89.5	88.5	90.2	89.5	89.5	88.5
15.0	89.5	88.5	91.0	90.2	90.2	89.5	89.5	88.5
20.0	90.5	89.5	91.0	90.2	91.0	90.2	90.2	89.5
25.0	91.0	90.2	91.7	91.0	91.7	91.0	90.2	89.5
30.0	91.0	90.2	92.4	91.7	92.4	91.7	91.0	90.2
40.0	91.7	91.0	93.0	92.4	93.0	92.4	91.0	90.2
50.0	92.4	91.7	93.0	92.4	93.0	92.4	91.7	91.0
60.0	93.0	92.4	93.6	93.0	93.6	93.0	92.4	91.7
75.0	93.0	92.4	94.1	93.6	93.6	93.0	93.6	93.0
100.0	93.0	92.4	94.1	93.6	94.1	93.6	93.6	93.0
125.0	93.6	93.0	94.5	94.1	94.1	93.6	93.6	93.0
150.0	93.6	93.0	95.0	94.5	94.5	94.1	93.6	93.0
200.0	94.5	94.1	95.0	94.5	94.5	94.1	93.6	93.0
Full-Load Efficiencies – Enclosed Motors								
HP	2-Pole		4-Pole		6-Pole		8-Pole	
	Nominal Efficiency	Minimum Efficiency	Nominal Efficiency	Minimum Efficiency	Nominal Efficiency	Minimum Efficiency	Nominal Efficiency	Minimum Efficiency
1.0	75.5	74.0	82.5	81.5	80.0	78.5	74.0	72.0
1.5	82.5	81.5	84.0	82.5	85.5	84.0	77.0	75.5
2.0	84.0	82.5	84.0	82.5	86.5	85.5	82.5	81.5
3.0	85.5	84.0	87.5	86.5	87.5	86.5	84.0	82.5
5.0	87.5	86.5	87.5	86.5	87.5	86.5	85.5	84.0
7.5	88.5	87.5	89.5	88.5	89.5	88.5	85.5	84.0
10.0	89.5	88.5	89.5	88.5	89.5	88.5	88.5	87.5
15.0	90.2	89.5	91.0	90.2	90.2	89.5	88.5	87.5
20.0	90.2	89.5	91.0	90.2	90.2	89.5	89.5	88.5
25.0	91.0	90.2	92.4	91.7	91.7	91.0	89.5	88.5
30.0	91.0	90.2	92.4	91.7	91.7	91.0	91.0	90.2
40.0	91.7	91.0	93.0	92.4	93.0	92.4	91.0	90.2
50.0	92.4	91.7	93.0	92.4	93.0	92.4	91.7	91.0
60.0	93.0	92.4	93.6	93.0	93.6	93.0	91.7	91.0
75.0	93.0	92.4	94.1	93.6	93.6	93.0	93.0	92.4
100.0	93.6	93.0	94.5	94.1	94.1	93.6	93.0	92.4
125.0	94.5	94.1	94.5	94.1	94.1	93.6	93.6	93.0
150.0	94.5	94.1	95.0	94.5	95.0	94.5	93.6	93.0
200.0	95.0	94.5	95.0	94.5	95.0	94.5	94.1	93.6

Subchapter V Lighting Power

Comm 63.40 Scope. Sections 63.41 to 63.51 shall apply to the following rooms, spaces and areas:

- (1) Interior spaces of buildings;
- (2) Building exteriors and exterior areas such as entrances, exits, loading docks; and
- (3) Roads, grounds, parking, and other exterior areas where lighting is energized through the building electrical service.

Note: See Appendix for worksheets.

History: Cr. Register, March, 1997, No. 495, eff. 4-1-97.

Comm 63.41 Exterior lighting power requirement.

The exterior lighting power of a building or a group of buildings in a multibuilding facility calculated in accordance with s. Comm 63.42 shall be no greater than the lighting power allowance calculated in accordance with s. Comm 63.43.

History: Cr. Register, March, 1997, No. 495, eff. 4-1-97.

Comm 63.42 Calculation of exterior lighting power.

The calculated exterior lighting power is the sum of the power for all exterior luminaires that are included in the scope of this subchapter, s. Comm 63.40, minus the power for exempted exterior lighting as specified in subs. (1) to (5):

- (1) Task lighting for outdoor activities such as manufacturing, commerce, and processing facilities.
- (2) Lighting power for theatrical productions.
- (3) Lighting for outdoor athletic facilities, including playing and seating areas.

(4) Lighting for dwelling units that is controlled within the dwelling unit.

(5) Exit way or egress lighting required by s. Comm 73.21 that has switching regulated by Article 700 of the National Electrical Code as adopted by reference in ch. Comm 16.

History: Cr. Register, March, 1997, No. 495, eff. 4-1-97.

Comm 63.43 Exterior lighting power allowance.

(1) **CALCULATION METHOD.** The exterior lighting power allowance for a building or a multibuilding facility is the sum of all the allowed lighting powers for all exterior areas. The lighting power for each area is calculated by multiplying the unit power allowance from Table 63.43 by the applicable length or area.

(2) **APPLICABLE AREAS AND LENGTHS.** The applicable areas and lengths used with Table 63.43 to calculate the exterior lighting power allowance are described in pars. (a) to (d).

(a) Horizontal areas of grounds, driveways, lots, gardens or parks may be calculated as if they were flat, or the actual area of the surfaces of contours may be used.

(b) Canopied areas are the area of the horizontal surface under the canopy. A canopy includes an exterior awning, soffit or ornamental or functional structure signifying a main entrance to a building.

(c) The linear length of door openings is measured in plan view and includes the door opening only. Sidelights and other portions of the door which do not open are not included.

(d) The applicable area of the building facade includes all vertical and horizontal areas that are intended to be illuminated.

History: Cr. Register, March, 1997, No. 495, eff. 4-1-97.

Table 63.43
Exterior Lighting Unit Power Allowances

Area Description	Allowances
Exit (with or without canopy)	25 W/lin ft of door opening
Entrance (without canopy)	30 W/lin ft of door opening
Entrance (with canopy)	
High traffic (retail, hotel, airport, theater, etc.)	10 W/ft ² of canopied area
Light traffic (hospital, office, school, etc.)	4 W/ft ² of canopied area
Loading area	0.40 W/ft ²
Loading door	20 W/lin ft of door opening
Building exterior surfaces/facades	0.25 W/ft ² of surface area to be illuminated
Storage and nonmanufacturing work areas	0.20 W/ft ²
Other activity areas for casual use such as picnic grounds, gardens, parks and other landscaped areas.	0.10 W/ft ²
Private driveways/walkways	0.10 W/ft ²
Public driveways/walkways	0.15 W/ft ²
Private parking lots	0.12 W/ft ²
Public parking lots	0.18 W/ft ²

Comm 63.44 Interior lighting power requirement.

The interior lighting power of a building calculated in accordance with s. Comm 63.45 shall be no greater than the interior lighting power allowance calculated in accordance with s. Comm 63.46.

History: Cr. Register, March, 1997, No. 495, eff. 4-1-97.

Comm 63.45 Calculation of interior lighting power.

The calculated interior lighting power of a building is the total watts of all interior luminaires including, but not limited to, track and flexible lighting systems, lighting that is integral with modular furniture, movable displays and cabinets, and internally illuminated case work for task or display purposes, minus any adjustments allowed under subs. (1) through (4).

(1) **MULTIPLE INTERLOCKED LIGHTING SYSTEMS SERVING A SPACE.** When multiple interlocked lighting systems serve a space, the watts of all systems except the system with the highest wattage may be excluded from the calculated lighting power if:

(a) The lighting systems are interlocked to prevent simultaneous operation; or

(b) The lighting systems are controlled by a preset dimming system or other device that prevents simultaneous operation of more than one lighting system, except under the direct control of authorized personnel.

(2) REDUCTION OF WATTAGE THROUGH CONTROLS. The watts of any luminaire that is controlled may be reduced by the number of watts times the applicable power adjustment factor from Table 63.45 if:

- (a) The control complies with s. Comm 63.51; and
- (b) At least 50% of the light output of the luminaire is within the applicable space listed in Table 63.45; and
- (c) Except as noted in Table 63.45, only one power adjustment

factor is used for the luminaire; and

(d) For daylighting control credits, the luminaire is controlled by the daylighting control, and the luminaire is located within the daylit area; and

(e) For automatic time switch control devices, a timed manual override is provided at each switch location required by s. Comm 63.50. The override device shall control only the lights in the surrounding area enclosed by ceiling-height partitions.

Table 63.45
Lighting Power Adjustment Factors

Type of control	Type of space	Factor
Automatic daylighting controls	Daylit areas	
Continuous dimming		0.30
Multiple step dimming		0.20
On/off		0.10
Automatic time switch control device in conjunction with automatic daylighting controls	Daylit areas \leq 250 square feet	
Continuous dimming		0.35
Multiple step dimming		0.25
On/off		0.15
Automatic time switch control device in conjunction with lumen maintenance and automatic daylighting controls	Daylit areas \leq 250 square feet	
Continuous dimming		0.40
Multiple step dimming		0.30
On/off		0.20
Lumen maintenance	Any space	0.10
Lumen maintenance in conjunction with an automatic time switch control device	Spaces \leq 250 square feet	0.15
Automatic time switch control device	Spaces \leq 250 square feet	0.15
Occupant-sensing device with a separate sensor for each space	Spaces \leq 250 square feet enclosed by opaque floor-to-ceiling partitions; any size classroom, corridor, conference or waiting room	0.30*
Occupant-sensing device with separate sensor for each space	Rooms of any size that are used exclusively for storage	0.60*
Occupant-sensing device with separate sensor for each space	Spaces $>$ 250 square feet	0.10*
Occupant-sensing device with a separate sensor for each space used in conjunction with daylighting controls and separate sensor for each space	Spaces \leq 250 square feet within a daylit area and enclosed by opaque floor-to-ceiling partitions	
Continuous dimming		0.40*
Multiple step dimming		0.35*
On/off		0.35*
Occupant-sensing device with a separate sensor for each space used in conjunction with daylighting controls and separate sensor for each space and lumen maintenance	Spaces \leq 250 square feet within a daylit area and enclosed by opaque floor-to-ceiling partitions	0.35*
Continuous dimming		0.45*
Multiple step dimming		0.40*
On/off		0.35*
Occupant-sensing device with a separate sensor for each space used with lumen maintenance	Spaces \leq 250 square feet and enclosed by opaque floor-to-ceiling partitions	0.35*
Occupant-sensing device with a separate sensor for each space used in conjunction with an automatic time switch control device	Spaces \leq 250 square feet enclosed by opaque floor to ceiling partitions	0.35*
Manual dimming system	Hotels, motels, restaurants, auditoriums, theaters	0.10
Multiscene programmable dimming system	Hotels, motels, restaurants, auditoriums, theaters	0.20
Occupant-sensing device with programmable multiscene dimming system	Hotels, motels, restaurants, auditoriums, theaters	0.35

*Note to Table 63.45: Adjustment factors for occupant-sensing devices are for devices with on-off operation. If devices are used that turn lights down, rather than off, the adjustment factor shall be multiplied by the percent of energy savings that occur while the lights are turned down.

(3) LIGHTING WATTAGE EXCLUDED. The watts of the following lighting applications may be excluded from the calculated interior lighting power of the building.

(a) Lighting for theatrical productions and other live performances, television broadcasting, audio-visual presentations, and those portions of entertainment facilities such as stage areas in

hotel ballrooms, night clubs, dance floors, and casinos where lighting is an essential technical element for the function performed, if the lighting is an addition to a general lighting system, and if the lighting is separately controlled and accessible only to authorized operators.

- (b) Lighting for television, video and film production.
- (c) Lighting for photographic processes.
- (d) Lighting for theme parks.
- (e) Lighting for exhibits in areas such as exhibit, convention, and hotel function areas, if the lighting is an addition to a general lighting system, and if the lighting is separately controlled and accessible only to authorized operators.
- (f) Specialized local lighting installed in nonlighting process equipment by its manufacturer used to illuminate process related tasks only.
- (g) In buildings for medical and clinical care, examination and surgical lights, low-level night lights, and lighting integral to medical equipment.
- (h) Lighting fixtures that are an integral part of refrigeration equipment.
- (i) Nonretail display lighting required for art exhibits or displays in galleries, museums and monuments.
- (j) Special lighting needed for research.
- (k) Task lighting for plant growth or maintenance, if it is equipped with an automatic 24-hour time switch that has program back-up capabilities that prevent the loss of the switch's program and time setting for at least 10 hours if power is interrupted.
- (L) Exit way or egress illumination that is normally off.
- (m) Task lighting specifically designed for primary use by visually impaired, for lip reading, and by senior citizens.
- (n) Lighting for signs, including exit signs.

Note: See s. Comm 63.52 for exit sign requirements.

- (o) Display window lighting in retail facilities provided the display area is separated from the store sales area by opaque ceiling-height partitions.
- (p) Lighting in dwelling units that provide complete independent living facilities for one or more persons including permanent provisions for living, sleeping, eating, cooking, and sanitation.
- (q) In restaurant buildings and areas, lighting for food warming or integral to food preparation equipment.
- (r) Lighting equipment that is for sale.
- (s) Lighting demonstration equipment in lighting education facilities.

(4) LIGHTING FIXTURES THAT ALLOW SUBSTITUTION OF SOURCES. The watts of track and other lighting fixtures that allow the substitution of low efficacy sources for high efficacy sources without altering the wiring of the fixture shall be determined by this subsection or other method approved by the department.

(a) *Track lighting.* The wattage of track lighting shall be determined by the method described in subd. 1. or 2.

1. The wattage of track lighting shall be the larger of the following two values:
 - a. 45 watts per foot of track; or
 - b. The total luminaire wattage proposed to operate on each track.
 2. If interlocked switching is provided that limits the circuits that can be operated simultaneously, the wattage shall be the maximum luminaire wattage that can be operated simultaneously.
- (b) *Incandescent medium base sockets.* The wattage for medium base fixtures shall be the listed lighting power capacity, in watts, of the fixture.

Note: See Appendix for default lamp/ballast wattages acceptable to the department.

History: Cr. Register, March, 1997, No. 495, eff. 4-1-97.

Comm 63.46 Calculation of interior lighting power allowance. The interior lighting power allowance shall be calculated using one of the methods in s. Comm 63.47, 63.48, or 63.49 as applicable.

History: Cr. Register, March, 1997, No. 495, eff. 4-1-97.

Comm 63.47 Complete building method. The Complete Building Method may be used only on projects involving entire buildings where plans and specifications are submitted for the entire building and at least 80 percent of the areas of the building are the same type of use. Under this approach, the interior lighting power allowance is the lighting power density value in Table 63.47 times the conditioned floor area of the entire building. Hotel, motel and residential buildings shall not use this method. Building uses that are not listed in Table 63.47 shall be assigned the allowed lighting power density given under "All Others."

Table 63.47

Complete Building Method

Lighting Power Density Values (Watts/ft²)

Type of Use	Allowed Lighting Power Density
Banks and Financial Institutions	1.7
Correctional Housing	1.4
General Commercial and Industrial Work Buildings	1.2
Grocery Store	1.8
Industrial and Commercial Storage Buildings	0.8
Medical Buildings and Clinics	1.5
Office Building	1.5
Religious Worship, Auditorium, and Convention Centers	2.0
Restaurants	1.5
Retail and Wholesale Store	2.0
Schools	1.8
Theaters	1.5
All Others	0.8

History: Cr. Register, March, 1997, No. 495, eff. 4-1-97.

Comm 63.48 Area category method. Under the Area Category Method, the interior lighting power allowance for the building is the sum of all allowed lighting powers for all areas in the building. The allowed lighting power for an area is the lighting power density in Table 63.48 times the area. For purposes of the Area Category Method, an "Area" means all contiguous spaces which accommodate or are associated with a single one of the primary functions listed in Table 63.48. Buildings with primary functions not listed in Table 63.48 shall not use this method. Where areas are bounded or separated by interior partitions, the floor space occupied by those interior partitions shall not be included in any area. The area shall not include enclosed retail display windows with exempted lighting as described in s. Comm 63.45 (3) (o). When the Area Category Method is used to calculate the interior lighting power allowance for an entire building, main entry lobbies, corridors, rest rooms, and support functions shall be treated as separate areas.

Table 63.48
Area Category Method – Lighting Power
Density Values (Watts/ft²)

Primary Function	Allowed Lighting Power Density
Auditorium	2.0
Bank/Financial Institution	1.8
Classrooms	2.0
Convention, Conference and Meeting Centers	1.6
Corridors, Rest Rooms and Support Areas	0.8
Detention Facilities	1.6
Dining	1.2
Exhibit	2.3
Storage Garage	0.2
General Commercial and Industrial Work	1.3
Grocery	2.0
Hotel Function	2.3*
Industrial and Commercial Storage	0.6
Kitchen	2.2
Laboratory	3.3
Living Unit or Guest Room	1.4
Lobbies:	
Hotel Lobby	2.3*
Main Entry Lobby	1.6*
Malls, Arcades, and Atria	1.2*
Medical and Clinical Care	1.8
Office	1.6
Precision Commercial and/or Industrial Work	2.0
Religious Worship	2.2*
Retail Sales, Wholesale Showrooms	2.2
Theaters:	
Motion Picture	1.0
Performance	1.5*

* Note to Table 63.48: The smallest of the following values may be added to the allowed lighting power listed in Table 63.48 for ornamental chandeliers and sconces that are switched or dimmed on circuits different from the circuits for general lighting:

a. One watt per square foot times the area of the space in which the chandelier or sconce is used; or

b. The actual design wattage of the chandelier or sconce.

History: Cr. Register, March, 1997, No. 495, eff. 4-1-97.

Comm 63.49 Activity method. Under the activity method, the interior lighting power allowance for a building is determined by calculating a lighting power budget for each space in accordance with subs. (1) to (4) and summing them in accordance with sub. (5).

(1) The lighting power budget of each interior space shall be determined in accordance with the equation given below:

$$LPB = A \times UPD \times AF$$

Where:

LPB = lighting power budget of the space, W

A = area of the space, ft²

UPD = unit power density, W/ft² [Table 63.49]

AF = area factor of the room [Figure 63.49]

(a) The UPD shall be selected from Table 63.49. For applications to areas or activities other than those given, select values for the most similar areas or activities. The UPD for a multifunctional space shall be based on the lowest UPD of any of the activities of the space.

(b) The area factor (AF) shall be determined from Figure 63.49 based on the room area (A_r) and ceiling height. The room area shall be calculated from the inside dimensions of the room. Rooms of identical ceiling height and activities may be evaluated as a group. The AF of a group of rooms shall be determined from the average area of these rooms.

The equation below gives the formula used in developing Figure 63.49.

$$AF = 0.2 + 0.8(1/0.9^n)$$

Where:

$$n = \left[\frac{10.21(CH-2.5)}{\sqrt{A_r}} \right] - 1$$

AF = Area factor

CH = Ceiling height, ft.

A_r = Room area, ft²

If AF < 1.0, then AF = 1.0

If AF > 1.8, then AF = 1.8

(2) For rooms serving multiple functions such as hotel banquet or meeting rooms and office conference or presentation rooms; an adjustment factor of 1.5 times the UPD may be used if a supplementary system is actually installed and meets the following conditions:

(a) The installed power for the supplementary system shall not be greater than 33 percent of the adjusted lighting power budget calculated for that space, and

(b) Independent controls shall be installed for the supplementary system.

(3) In rooms containing multiple simultaneous activities, such as a large general office having separate accounting and drafting areas within the same room, the lighting power budget for the rooms shall be the weighted average of the activities in proportion to the areas being served.

(4) The activity of indoor sports areas shall be considered as an area 10 feet beyond the playing boundaries of the sport, not to exceed the total floor area of the indoor sports space less the spectator seating area.

(5) The interior lighting power allowance shall be calculated in accordance with the equation given below. The interior lighting power allowance shall include a 0.20 W/ft² allowance for unlisted spaces.

$$ILPA = (LPB_1 + LPB_2 + \dots + LPB_n) + (0.20 \text{ W/ft}^2 \times \text{unlisted space area})$$

Where:

ILPA = interior lighting power allowance, W

Unlisted space area = GLA - ∑(LS), ft²

GLA = gross lighted area, ft²

LPB = lighting power budget, W

LS = listed space

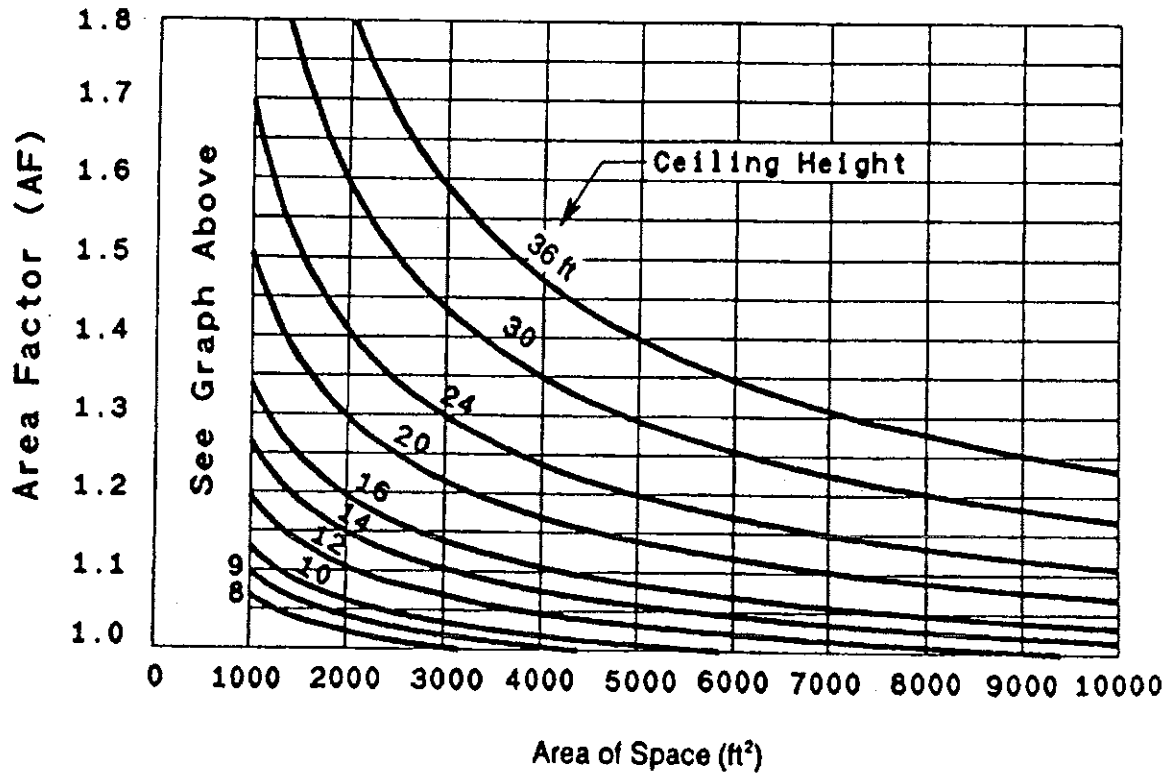
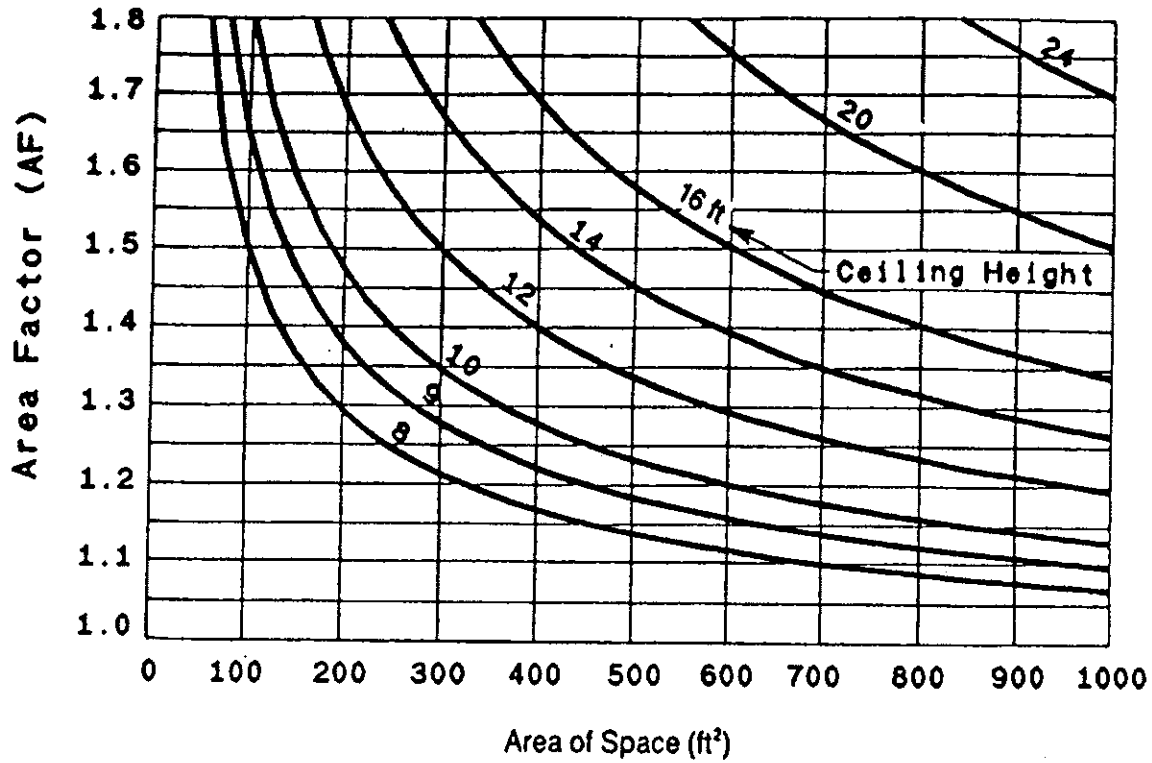


Figure 63.49 Area Factor

**Table 63.49
Unit Power Densities**

Part a – Common Activity Areas		
Activity/Area	UPD W/ft²	Note
Auditorium	1.6	a
Corridor	0.8	b
Classroom/Lecture Hall	2.0	
Electrical/Mechanical Equipment Room		
General	0.7	b
Control Rooms	1.5	b
Food Service		
Fast Food/Cafeteria	1.3	
Leisure Dining	2.5	c
Bar Lounge	2.5	c
Kitchen	1.4	
Recreation/Lounge	0.7	
Stair		
Active Traffic	0.6	
Emergency Exit	0.4	
Toilet and Washroom	0.8	
Garage		
Auto and Pedestrian Circulation Area	0.3	
Parking Area	0.2	
Laboratory	3.0	
Library		
Audio/Visual	1.1	
Stack Area	1.5	
Card File and Cataloging	1.6	
Reading Area	1.9	
Lobby (General)		
Reception and Waiting	1.0	
Elevator Lobbies	0.8	
Atrium (Multistory)		
First Three Floors	0.7	
Each Additional Floor	0.2	
Locker Room and Shower	0.8	
Office Category 1		
Enclosed offices, all open plan offices without partitions or with partitions* lower than 4.5 feet below the ceiling		
Reading, Typing and Filing	1.8	d
Drafting	2.6	d
Accounting	2.1	d
Office Category 2		
Open plan offices 900 square feet or larger with partitions* 3.5 to 4.5 feet below the ceiling offices less than 900 square feet shall use Category 1		
Reading, Typing and Filing	1.9	b
Drafting	2.9	b
Accounting	2.4	b

Table 63.49 (continued)
Unit Power Densities

Part a - Common Activity Areas (Continued)		
Activity/Area	UPD W/ft ²	Note
Office Category 3		
Open plan offices 900 square feet or larger with partitions* higher than 3.5 feet below the ceiling offices less than 900 square feet shall use Category 1		
Reading, Typing and Filing	2.2	b
Drafting	3.4	b
Accounting	2.7	b
Common Activity Areas		
Conference Meeting Room	1.8	a
Computer Office Equipment	2.1	
Filing, Inactive	1.0	
Mail Room	1.8	
Shop (Nonindustrial)		
Machinery	2.5	
Electrical/Electronic	2.5	
Painting	1.6	
Carpentry	2.3	
Welding	1.2	
Storage and Warehouse		
Inactive Storage	0.3	
Active Storage, Bulky	0.3	
Active Storage, Fine	1.0	
Material Handling	1.0	
Unlisted Space	0.2	

* Not less than 90 percent of all work stations shall be individually enclosed with partitions of at least the height described.

Part b - Specific Buildings

Activity/Area	UPD W/ft ²	Note
Airport, Bus and Rail Station		
Baggage Area	1.0	
Concourse/Main Thruway	0.9	
Ticket Counter	2.5	
Waiting and Lounge Area	1.2	
Bank		
Customer Area	1.1	
Banking Activity Area	2.8	
Barber and Beauty Parlor	2.0	
Church, Synagogue, Chapel		
Worship/Congregational	2.5	
Preaching and Sermon	2.7	
Dormitory		
Bedroom	1.1	
Bedroom With Study	1.4	
Study Hall	1.8	

Table 63.49 (continued)
Unit Power Densities

Part b – Specific Buildings (Continued)		
Activity/Area	UPD W/ft²	Note
Fire and Police Department		
Fire Engine Room	0.7	
Detention Dayroom	1.5	
Jail Cell	1.2	
Hospital/Nursing Home		
Corridor	1.3	b
Dental Suite/Examination/Treatment	1.6	
Emergency	2.3	
Laboratory	3.0	
Lounge/Waiting Room	0.9	
Medical Supplies	2.4	
Nursery	2.0	
Nurse Station	2.1	
Occupational Therapy/Physical Therapy	1.6	
Patient Room	1.4	
Pharmacy	1.7	
Radiology	2.1	
Surgical and O.B. Suites		
General Area	2.1	
Operating Room	7.0	
Recovery	2.3	
Hotel/Conference Center		
Banquet Room/Multipurpose	2.4	a
Bathroom/Powder Room	1.2	
Guest Room	1.4	
Public Area	1.2	
Exhibition Hall	2.6	
Conference/Meeting	1.8	a
Lobby	1.9	
Reception Desk	2.4	
Laundry		
Washing	0.9	
Ironing and Sorting	1.3	
Museum and Gallery		
General Exhibition	1.9	
Inspection/Restoration	3.9	
Storage (Artifacts)		
Inactive	0.6	
Active	0.7	
Post Office		
Lobby	1.1	
Sorting and Mailing	2.1	
Service Station/Auto Repair	1.0	

Table 63.49 (continued)
Unit Power Densities

Part b – Specific Buildings (Continued)		
Activity/Area	UPD W/ft ²	Note
Theater		
Performance Arts	1.5	
Motion Picture	1.0	
Lobby	1.5	
Retail Establishments		
Merchandising and Circulation Area – Applicable to all lighting, including accent and display lighting, installed in merchandising and circulation areas	2.2	
Mall Concourse	1.4	
Retail Support Areas		
Tailoring	2.1	
Dressing/Fitting Rooms	1.4	
Part c – Indoor Athletic Areas ^{e,f}		
Activity/Area	UPD W/ft ²	Note
Seating Area, All Sports	0.4	
Badminton		
Club	0.5	
Tournament	0.8	
Basketball/Volleyball		
Intramural	0.8	
College	1.3	
Professional	1.9	
Bowling		
Approach Area	0.5	
Lanes	1.1	
Boxing or Wrestling (platform)		
Amateur	2.4	
Professional	4.8	
Gymnasium		
General Exercising and Recreation Only	1.0	
Handball/Raquetball/Squash		
Club	1.3	
Tournament	2.6	
Hockey, Ice		
Amateur	1.3	
College or Professional	2.6	
Skating Rink		
Recreational	0.9	
Exhibition/Professional	2.6	
Swimming		
Recreational	0.9	
Exhibition	1.5	
Under Water	1.0	

Table 63.49 (continued)
Unit Power Densities

Part c – Indoor Athletic Areas^{e,f} (Continued)

Activity/Area	UPD W/ft ²	Note
Tennis		
Recreational (Class III)	1.3	
Club/College (Class II)	1.9	
Professional (Class I)	2.6	
Tennis, Table		
Club	1.0	
Tournament	1.6	

Notes for Table 63.49:

Note a. A 1.5 power adjustment factor is applicable for multifunctional spaces.

Note b. Area factor of 1.0 shall be used for these spaces.

Note c. UPD includes lighting power required for clean-up purpose.

Note d. Area factor shall not exceed 1.55.

Note e. Area factor of 1.0 shall be used for all indoor athletic spaces.

Note f. Facilities that are used for more than one level of play shall have appropriate switching between the different levels specified in Table 63.49. Dimming shall not be used to accomplish the reduction in illumination. The illumination at all levels shall be uniform.

History: Cr. Register, March, 1997, No. 495, eff. 4-1-97.

Comm 63.50 Lighting controls that must be installed. (1) AREA CONTROLS. (a) Except as provided in pars. (c) and (d), each interior area enclosed by ceiling-height partitions shall have an independent switching or control device. This switching or control device shall be:

1. Readily accessible; and
2. Located so that a person using the device can see the lights or area controlled by that switch, or so that the area being lit is annunciated; and
3. Manually operated, or automatically controlled by an occupant-sensing device that meets the requirements of s. Comm 63.51 (4).

(b) Other devices may be installed in conjunction with the switching or control device required by par. (a) provided that they:

1. Permit the required switching or control device to override the action of the other devices; and
2. Reset the mode of any automatic system to normal operation without further action.

(c) Up to one-half watt per square foot of lighting in any area within a building that must be continuously illuminated for reasons of building security or emergency egress are exempt from par. (a) if:

1. The area is designated a security or emergency egress area on the plans and specifications submitted to the department; and
2. The area is controlled by switches accessible only to authorized personnel.

(d) Public areas with switches that are accessible only to authorized personnel are exempt from the area control requirements of par. (a).

(2) CONTROLS TO REDUCE LIGHTING. (a) Except as provided in par. (b), the general lighting of any enclosed interior space 100 square feet or larger in which the connected lighting load exceeds 1.2 watts per square foot for the space as a whole, and that has more than one light source or luminaire, shall be controlled so that the load for the lights may be reduced by at least one-half while maintaining a reasonably uniform level of illuminance throughout the area. A reasonably uniform reduction of illuminance shall be achieved by one of the following or other method approved by the department:

1. Controlling all lamps or luminaires with dimmers; or
2. Dual switching of alternate rows of luminaires, alternate luminaires, or alternate lamps; or
3. Switching the middle lamps of three lamp luminaires independently of the outer lamps; or

4. Switching each luminaire or each lamp.
- (b) The requirements of par. (a) do not apply to:
 1. Lights in areas that are controlled by an occupant-sensing device that meets the requirements of s. Comm 63.51 (4);

2. Lights in corridors; or
3. Lights in areas that are controlled by an automatic time switch control device that has a timed manual override available at each switch location required by sub. (1), and that controls only the lights in that area enclosed by ceiling height partitions.

(3) DAYLIT AREAS. (a) Except as provided in par. (b), daylight areas in any interior enclosed space greater than 250 square feet shall meet the requirements of subs. 1. and 2.

1. Such areas shall have at least one control that:
 - a. Controls only luminaires in the daylight area; and
 - b. Controls at least 50% of the lamps or luminaires in the daylight area, in a manner described in sub. (2)(a) 1. to 4., independently of all other lamps or luminaires in the enclosed space. The other luminaires in the enclosed space may be controlled in any manner allowed by sub. (2)(a) 1. to 4.
2. Such areas shall have controls that control the luminaires in each vertically daylight area separately from the luminaires in each horizontally daylight area.

(b) The requirements of this subsection do not apply to:

1. Daylit areas where the effective aperture of glazing is equal or less than 0.1 for vertical glazing and 0.01 for horizontal glazing; or

2. Daylit areas where existing adjacent structures or natural objects obstruct daylight to the extent that effective use of daylighting is not feasible.

(4) SHUT-OFF CONTROLS. (a) Except as provided in par. (b), for every floor or metered space, all interior lighting systems shall be equipped with at least one separate automatic control to shut off the lighting. This automatic control shall meet the requirements of s. Comm 63.51 and may be an occupancy sensor, automatic time switch, or other device capable of automatically shutting off the lighting.

- (b) The requirements of par. (a) do not apply to the following:
1. Buildings or separately metered spaces of less than 5,000 square feet of conditioned space;
 2. Where the system is serving an area that must be continuously lit, or where the use of the space prohibits the use of a preestablished lighting program;
 3. Lighting in corridors, guest rooms, and lodging quarters of residential buildings hotels and motels;

4. Up to one-half watt per square foot of lighting in any area within a building that must be continuously illuminated for reasons of building security or emergency egress, if:

a. The area is designated a security or emergency egress area on the plans and specifications submitted to the department; or

b. The area is controlled by switches accessible only to authorized personnel.

(c) If an automatic time switch control device is installed to comply with par. (a), it shall incorporate an override switching device that:

1. Is readily accessible; and
2. Is located so that a person using the device can see the lights or the area controlled by that switch, or so that the area being lit is annunciated; and
3. Is manually operated; and
4. Allows the lighting to remain on for no more than 2 hours when an override is initiated; and
5. Controls an area not exceeding 5,000 square feet.
6. Two overrides may be provided for a maximum of 10,000 square feet if the lighting is dual level controlled in accordance with sub. (2) (a) 2. or 3.

(5) **DISPLAY LIGHTING CONTROLS.** Display lighting shall be separately switched on circuits that are 20 amps or less.

(6) **EXTERIOR LIGHTING CONTROLS.** Except in lighting in parking garages, tunnels, and large covered areas that require illumination during daylight hours, exterior lighting shall be controlled by a directional photocell or astronomical time switch that automatically turns off the exterior lighting when daylight is available. Time switches shall be equipped with back-up provisions to keep time during a power outage of 10 hours or more.

(7) **HOTEL AND MOTEL GUEST ROOM CONTROLS.** Hotel and motel guest rooms or suites excluding bathrooms shall have one or more master switches at the main entry door or at the entry door of each room that turn off all permanently wired lighting fixtures and switched receptacles in the room or suite.

History: Cr. Register, March, 1997, No. 495, eff. 4-1-97.

Comm 63.51 Requirements for lighting control devices. Automatic time switch control devices, occupant-sensing devices, automatic daylighting control devices, lumen maintenance control devices, or interior photocell sensor devices that are used to justify a wattage reduction factor in the calculation of the actual internal lighting power in s. Comm 63.45 (2) shall be approved for compliance with all of the applicable requirements of subs. (1) to (7) and shall be installed in compliance with sub. (8). Approval of devices shall be obtained via the material approval program in accordance with s. Comm 50.19 or via manufacturer certification to the California Energy Commission.

Note: Information on California Energy Commission Certification may be obtained from the California Energy Commission, Energy Efficiency and Local Assistance Division, 1516 9th Street, MS-2S, Sacramento, CA 95814-5512, 416/654-4021. A list of approved control devices is available on the internet at [ftp://sna.com/pub/users.../appliance-readme.txt](http://sna.com/pub/users.../appliance-readme.txt).

(1) **ALL DEVICES: INSTRUCTIONS FOR INSTALLATION AND CALIBRATION.** The manufacturer shall provide step-by-step instructions for installation and start-up calibration of the device.

(2) **ALL DEVICES: STATUS SIGNAL.** The device shall have an indicator that visibly or audibly informs the device operator that it is operating properly, or that it has failed or malfunctioned, except for photocell sensors or other devices where a status signal is infeasible because of inadequate power.

(3) **AUTOMATIC TIME SWITCH CONTROL DEVICES.** Automatic time switch control devices shall:

(a) Be capable of programming different schedules for weekdays and weekends; and

(b) Incorporate an automatic "holiday shut-off" feature that turns off all loads for at least 24 hours, then resumes the normally scheduled operation; and

(c) Have program backup capabilities that prevent the loss of the device's program and time setting for at least 10 hours if power is interrupted.

(4) **OCCUPANT-SENSING DEVICES.** Occupant-sensing devices shall be capable of automatically controlling all the lights in an area no more than 30 minutes after the area has been vacated. In addition, ultrasonic and microwave devices shall have a built-in mechanism that allows calibration of the sensitivity of the device to room movement in order to reduce the false sensing of occupants and shall comply with either par. (a) or (b), as applicable:

(a) If the device emits ultrasonic radiation as a signal for sensing occupants within an area, the device shall:

1. Have had an Initial Report submitted to the Bureau of Radiological Health, Federal Food and Drug Administration, under 21 CFR 1002.10; and

2. Emit no audible sound; and

3. Not emit ultrasound in excess of the decibel (dB) values given in Table 63.51 measured no more than 5 feet from the source on axis.

Table 63.51
Maximum Ultrasound Emissions

Midfrequency of Sound Pressure Third-Octave Band (in kHz)	Maximum dB Level within Third-Octave Band (in dB reference 20 micropascals)
less than 20	80
20 or more to less than 25	105
25 or more to less than 31.5	110
31.5 or more	115

(b) If the device emits microwave radiation as a signal for sensing occupants within area, the device shall:

1. Comply with all applicable provisions in 47 CFR Part 5, and have an approved Federal Communications Commission identification number that appears on all units of the device and that has been submitted to the department; and

2. Not emit radiation in excess of 1 milliwatt per square centimeter measured at no more than 5 centimeters from the emission surface of the device; and

3. Have permanently affixed to it installation instructions recommending that it be installed at least 12 inches from any area normally used by room occupants.

(5) **AUTOMATIC DAYLIGHTING CONTROL DEVICES.** Automatic daylighting control devices shall:

(a) Be capable of reducing the light output of the general lighting of the controlled area by at least one-half while maintaining a uniform level of illuminance throughout the area; and

(b) If the device is a dimmer, provide electrical outputs to lamps for reduced flicker operation through the dimming range and without causing premature lamp failure; and

(c) If the device is a stepped dimming system, incorporate time delay circuits to prevent cycling of light level changes of less than three minutes; and

(d) If the device uses step switching with separate "on" and "off" settings for the steps, have sufficient separation or deadband of "on" or "off" points to prevent cycling; and

(e) Have provided by the manufacturer step-by-step instructions for installation and start-up calibration to design foot-candle levels.

(6) **LUMEN MAINTENANCE CONTROL DEVICES.** Lumen maintenance control devices shall:

(a) Be capable of reducing the light output of the general lighting of the controlled area by at least 30% while maintaining a uniform illuminance throughout the area; and

(b) Provide electrical outputs to lamps for reduced flicker operation through the dimming range and without causing premature lamp failure; and

(c) Incorporate an alarm, either audible or visible, to announce when a specified setpoint of lumens or watts has been reached; and

(d) Have provided by the manufacturer step-by-step instructions for installation and start up calibration to design foot-candle levels.

(7) **INTERIOR PHOTOCCELL SENSOR DEVICES.** Interior photocell sensors shall not have a mechanical slide cover or other device that permits easy unauthorized disabling of the control, and shall not be incorporated into a wall-mounted occupant-sensing device.

(8) **INSTALLATION IN ACCORDANCE WITH MANUFACTURER'S INSTRUCTIONS.** If an automatic time switch control device, occupant-sensing device, automatic daylighting control device, lumen maintenance control device, or interior photocell sensor device is installed, it shall comply with both pars. (a) and (b).

(a) The device shall be installed in accordance with the manufacturer's instructions; and

(b) Automatic daylighting control devices and lumen maintenance control devices shall:

1. Be installed so that automatic daylighting control devices control only luminaries within the daylit area; and

2. Have photocell sensors that are either ceiling mounted or located so that they are accessible only to authorized personnel, and that are located so that they maintain adequate illumination in the area according to the designer's or manufacturer's instructions.

History: Cr. Register, March, 1997, No. 495, eff. 4-1-97.

Comm 63.52 Exit signs. Exit signs shall have an installed wattage of 20 watts or less.

History: Cr. Register, March, 1997, No. 495, eff. 4-1-97.

Comm 63.53 Reduction of single lamp ballasts. The following luminaries located within the same room shall be tandem wired or provided with three-lamp ballasts:

(1) One-lamp or three-lamp fluorescent luminaries recess-mounted within 10 feet center-to-center of each other; and

(2) One-lamp or three-lamp fluorescent luminaries pendant- or surface-mounted within one foot edge-to-edge of each other.

History: Cr. Register, March, 1997, No. 495, eff. 4-1-97.

Subchapter VI Nondepletable Energy Source

Comm 63.60 Buildings utilizing solar, geothermal, wind or other nondepletable energy source. Any building, or portion thereof, utilizing any nondepletable energy source shall meet all the requirements of this chapter. An energy credit will be given to the building envelope in the amount of the net nondepletable energy collected. The nondepletable energy must be derived from a specific collection, storage and distribution system, which may include active and passive systems.

Note: An energy credit to the building envelope in the amount of the net recovered energy will be given to the use of recovery systems which will conserve energy, provided the amount expended is less than the amount recovered when the energy transfer potential and the operating hours are considered.

History: Cr. Register, March, 1997, No. 495, eff. 4-1-97.

Comm 63.61 Documentation. Proposed alternative designs, submitted as variations to the standard design criteria, shall be accompanied by an energy analysis. This department will accept alternative systems designed according to the requirements of nationally recognized agencies.

History: Cr. Register, March, 1997, No. 495, eff. 4-1-97.

Subchapter VII System Analysis Design

Comm 63.70 Annual energy consumption. A building designed in accordance with this part will be deemed as complying with this chapter if the calculated annual energy consumption is not greater than a similar building with enclosure elements and energy consuming systems designed in accordance with subchs. I through V. If the proposed alternative design results in an increase in consumption of one energy source and a decrease in another energy source, the difference in each energy source shall be converted to equivalent energy units for purposes of comparing the total energy used.

Note: Use of the ASHRAE 90.1 Energy Cost Budget Method will not verify compliance with all portions of subchapters I through V. Compliance with the following sections of ch. Comm 63 must be shown independently if the Energy Cost Budget Method is used: ss. Comm 63.11 to 63.12, 63.20 to 63.29, 63.32 (2) and subchapter V.

History: Cr. Register, March, 1997, No. 495, eff. 4-1-97.

Comm 63.71 Simulation. The calculation procedure used to simulate the operation of the building and its service systems through a full year operating period shall be detailed to permit the evaluation of the effect of system design, climatic factors, operational characteristics, and mechanical equipment on annual energy usage. Manufacturer's data or comparable field test data shall be used when available in the simulation of all systems and equipment. The calculation procedure shall be based upon 8,760 hours of operation of the building and its service systems and shall utilize the following input:

(1) **CLIMATIC DATA.** Coincident hourly data for temperatures, solar radiation, wind and humidity of typical days in the year representing seasonal variation.

(2) **BUILDING DATA.** Orientation, size, shape, thermal mass, air moisture and heat transfer characteristics.

(3) **OPERATIONAL CHARACTERISTICS.** Temperature, humidity, ventilation, illumination, control mode for occupied and unoccupied hours.

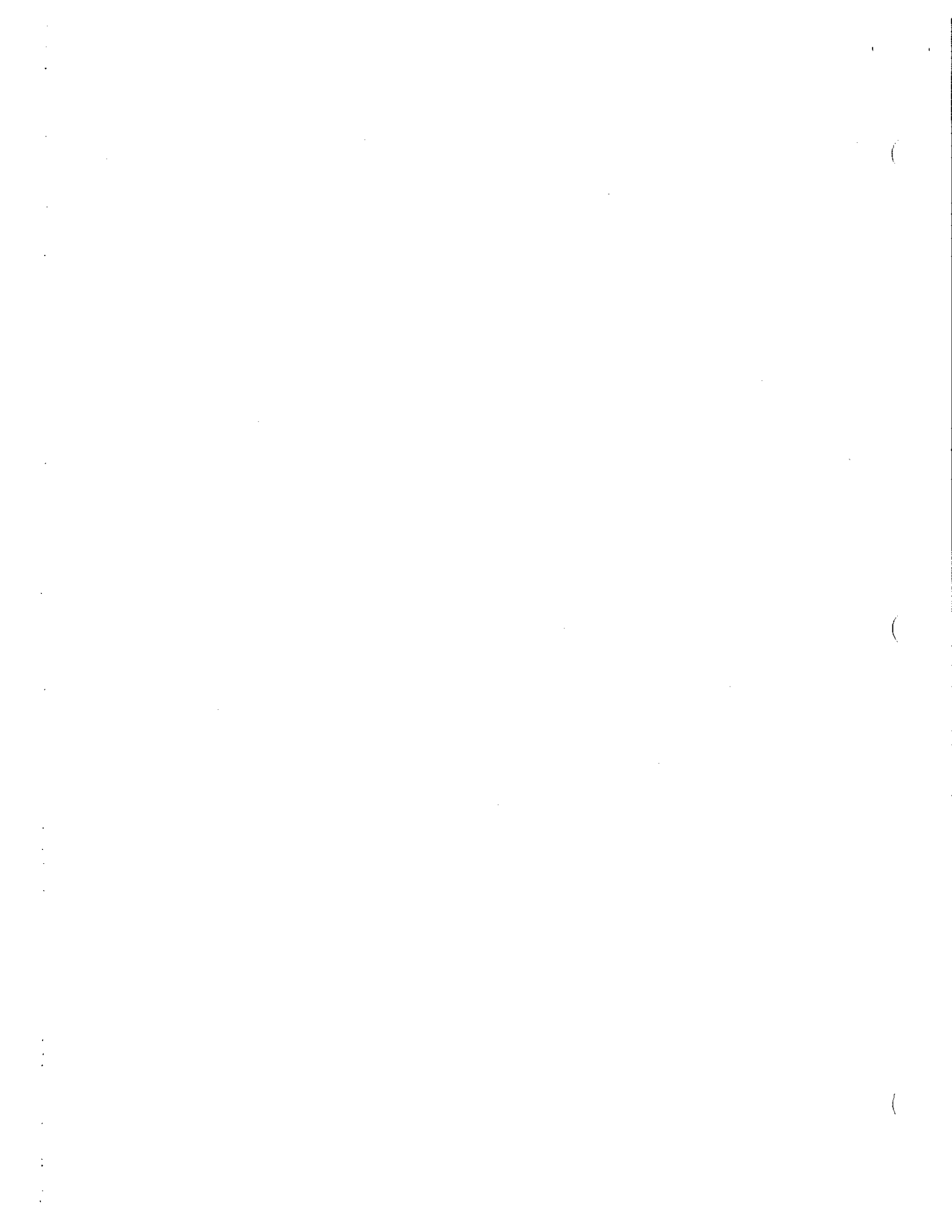
(4) **MECHANICAL EQUIPMENT.** Design capacity, partial load profile.

(5) **BUILDING LOADS.** Internal heat generation, lighting, equipment, number of people during occupied and unoccupied periods.

History: Cr. Register, March, 1997, No. 495, eff. 4-1-97.

Comm 63.72 Documentation. Proposed alternative designs, submitted as requests for exception to the standard design criteria, shall be accompanied by an energy analysis comparison report. The report shall provide technical detail on the building and system design and on the data used.

History: Cr. Register, March, 1997, No. 495, eff. 4-1-97.



Chapter Comm 64

HEATING, VENTILATING AND AIR CONDITIONING

Comm 64.01 Scope.
Comm 64.02 Approval of drawings and specifications.
Comm 64.025 Definitions.

Subchapter II — Design and Operation Requirements

Comm 64.03 Design.
Comm 64.04 Outside temperature design conditions.
Comm 64.05 Inside design temperatures and ventilation requirements.
Comm 64.06 Mechanical ventilation systems.
Comm 64.07 Natural ventilation system.
Comm 64.08 Exhaust ventilation system.
Comm 64.09 Combustion air intakes.
Comm 64.10 Refrigerants.

Subchapter III — Ventilation and Air Standards

Comm 64.11 Ventilation and air standards.
Comm 64.13 Tempered air requirements.
Comm 64.14 Tempered outside air requirements.
Comm 64.15 Air movement and distribution.
Comm 64.16 Air-cleaning devices.
Comm 64.17 Controls.
Comm 64.18 Contamination of air.
Comm 64.19 Location of outside ventilating air intakes or exhausts for mechanical ventilation systems.

Subchapter IV — Heating Equipment Requirements

Comm 64.20 Equipment ratings and safety controls.
Comm 64.21 Location of equipment.
Comm 64.22 Special requirements.
Comm 64.23 Piping.

Subchapter V — Air Delivery Systems

Comm 64.31 Duct design.
Comm 64.32 Duct use.
Comm 64.33 Underground duct construction and installation.
Comm 64.34 Duct construction.
Comm 64.35 Duct connectors.

Comm 64.36 Vertical shafts.
Comm 64.37 Insulation.
Comm 64.38 Gravity ventilation ducts.
Comm 64.39 Ventilation discharge.
Comm 64.40 Relief vents.
Comm 64.41 Plenums.
Comm 64.43 Dampers and damper controls.
Comm 64.44 Fans and blowers.

Subchapter VI — Chimneys, Gas Vents, Mechanical Draft and Venting Devices

Comm 64.45 Chimneys, Smoke stacks, gas vents, mechanical draft and venting devices.
Comm 64.46 Masonry chimneys.
Comm 64.47 Metal smokestacks.
Comm 64.48 Factory-built chimneys and gas vents.
Comm 64.49 Gas vents.
Comm 64.50 Chimney and vent connectors.

Subchapter VIII — Occupancy Requirements

Comm 64.51 Guarding and fire protection.
Comm 64.55 Theaters and places of assembly.
Comm 64.56 Schools and other places of instruction.
Comm 64.57 Health care facilities.
Comm 64.58 Penal institutions and places of detention.
Comm 64.59 Residential occupancies.
Comm 64.60 Day care facilities.
Comm 64.61 Repair areas.
Comm 64.62 Vehicle service buildings.
Comm 64.63 Garages.
Comm 64.64 Vehicle showrooms.
Comm 64.65 General sanitation and service areas.
Comm 64.66 Natatoriums.
Comm 64.67 Kitchens.
Comm 64.68 Seasonal occupancies.

Note: Chapter ILHR 64 was revised in December, 1995 effective April 1, 1996. On April 6, 1996 the department of industry, labor and human relations published an emergency rule stating that the effective date of the December, 1995 rule version was delayed. A permanent rule was adopted in December, 1996 stating that the revised text of ch. ILHR 64, as published, would be effective April 1, 1997.

Note: Chapter Ind 59 as it existed on December 31, 1975 was repealed and a new chapter Ind 64 was created effective January 1, 1976. Chapter Ind 64 was renumbered to be chapter Comm 64 effective January 1, 1984. Chapter ILHR 64 as it existed on March 31, 1997 was repealed and a new chapter ILHR 64 was created effective April 1, 1997. Corrections made under s. 13.93 (2m) (b) 1. and 7., Stats., Register, March, 1997, No. 495.

Note: Chapter ILHR 64 was renumbered to be Chapter Comm 64 under s. 13.93 (2m) (b) 1., Stats., and corrections made under s. 13.93 (2m) (b) 7., Stats., Register, September, 1998, No. 513.

Comm 64.01 Scope. (1) GENERAL. All heating, ventilating and air conditioning systems shall be designed, installed, maintained and operated so as to provide the service and results required within the provisions of this chapter. The minimum requirements established in each part of this chapter shall be complied with as they apply to that specific public building or place of employment. The administrative rules pertaining to energy conservation may be applied retroactively to existing buildings.

(2) ADDITIONS. The provisions of this chapter shall apply to additions to existing buildings and structures as specified in s. Comm 50.03. When an existing HVAC system is extended to serve an addition, existing system components are not required to be replaced if the requirements of this chapter are met within the addition.

(3) ALTERATIONS. (a) The provisions of this chapter shall apply to remodeling or alterations in any building or structure which affect the replacement of major equipment as specified in s. Comm 50.03.

(b) When an existing HVAC system serves a remodeled or altered space that has not undergone a change in occupancy or use,

the existing system components are not required to be replaced if the requirements of this chapter that applied to the original construction of the space are met.

Note: "Occupancy or use" refers to the entries in Table 64.05.

Note: Compliance with this code shall not constitute assurance of proper installation or operation of the heating, ventilating and air conditioning system. This code is not to be used as a design manual, but it is established as a minimum standard for safety, health and general welfare of the public.

History: Cr. Register, March, 1997, No. 495, eff. 4-1-97.

Comm 64.02 Approval of drawings and specifications. All drawings and specifications shall be submitted to the department in accordance with the provisions of ss. Comm 50.07 and 50.12.

History: Cr. Register, March, 1997, No. 495, eff. 4-1-97.

Comm 64.025 Definitions. In this chapter:

(1) "Air Change" means the introduction of new, cleansed, or recirculated air to a space.

(1m) "Air change rate" means airflow in volume units per hour divided by the building space volume in identical volume units.

(2) "Air conditioning" means the process of treating air to control temperature or humidity and distributing to meet the requirements of the conditioned space.

(3) "Exhaust vent" means a vent, including a relief vent, through which air is exhausted from a space to the atmosphere.

(4) "Exhaust ventilating system" means any combination of building construction, machinery, devices or equipment, designed and operated to remove gases, dusts, fumes or vitiated air from the breathing zone of employees and frequenters.

(5) "Gravity exhaust ventilation" means a process of removing air by natural means, the effectiveness depending on atmo-

spheric condition, such as difference in relative density, difference in temperature or wind motion.

(6) "Mechanical ventilation" means the process of supplying a mixture of tempered outside air or simultaneously removing contaminated air to the outside by power-driven fans or blowers or both.

(7) "Outside air" means air that is taken from outside the building and is free from contamination of any kind in proportions detrimental to the health or comfort of the general population exposed to it.

(8) "Recirculated air" means the transfer of air from a space through the air-handling equipment and back to the space.

(9) "Spot heating" means to provide heat to raise the air temperature to the required minimum in the immediate area of the occupants.

(10) "Tempered air" means air transferred from a heated or cooled area of a building.

(11) "Tempered outside air" means outside air heated or cooled before distribution.

(12) "Ventilation" means the process of supplying or removing air by natural or mechanical means, to or from any space.

History: Cr. Register, March, 1997, No. 495, eff. 4-1-97.

Subchapter II — Design and Operation Requirements

Comm 64.03 Design. (1) **BUILDING HEAT LOSS.** The total building heat loss shall be equal to the sum of the building transmission losses and infiltration or the building transmission losses and ventilation losses, whichever sum is greater.

(2) **HEATING SYSTEM DESIGN.** The primary heating system intended to maintain the inside design temperature of s. Comm 64.05 (1) shall be designed to equalize building transmission losses and infiltration or ventilation losses during occupied periods. Credit will be given for internal heat gains against the total design loss of the heating system, provided the heat gains are demonstrated by the designer.

(3) **CAPACITY AND ARRANGEMENT.** The calculated capacity and the arrangement of all installations for required heating and ventilating shall be based upon simultaneous service to all parts of the building unless otherwise exempted by this code.

History: Cr. Register, March, 1997, No. 495, eff. 4-1-97.

Comm 64.04 Outside temperature design conditions. Outside design temperatures shall be taken from either Figure 63.23 or ASHRAE 90.1.

History: Cr. Register, March, 1997, No. 495, eff. 4-1-97.

Comm 64.05 Inside design temperatures and ventilation requirements. (1) **INSIDE DESIGN TEMPERATURES.** (a) *Heating system design.* The heating system shall be designed to maintain a temperature of not less than that shown in Table 64.05 and must be operated at not less than that temperature during occupied periods.

(b) *Spot heating.* Spot heating may be used to heat individual fixed work stations in large industrial buildings where it is impractical to provide heat to the entire space as described in par. (a), provided the inside design temperature at the fixed work station is at least 60°F.

(2) **VENTILATION REQUIREMENTS.** The ventilating system shall be designed, maintained and operated to accomplish the required minimum ventilation indicated in Table 64.05. The required ventilation for areas of each occupancy or use is specified by the ven-

tilation classification assigned to each occupancy or use in Table 64.05. Areas of different ventilation classification shall be provided with a complete solid separation or the most stringent ventilation requirement shall apply to all unseparated areas.

(a) Areas assigned ventilation classification (a) shall be provided with a supply of outside air and an equal amount of exhaust ventilation at a rate of 7.5 cubic feet per minute per person within the area served by the system and with a minimum air change rate as specified in s. Comm 64.06 (2).

(b) Areas assigned ventilation classification (b) shall be provided with a supply of outside air and an equal amount of exhaust ventilation at a rate of 7.5 cubic feet per minute per person within the area served by the system and with a minimum air change rate as specified in s. Comm 64.06 (2), or shall be provided with a percentage of openings in accordance with sub. (3).

(c) Areas assigned ventilation classification (c) shall be provided with a supply of outside air and exhaust ventilation determined using the cfm per square foot of net floor area specified in Table 64.05.

(d) Areas assigned ventilation classification (d) shall be provided with an amount of exhaust ventilation determined using the cfm per square foot of net floor area specified in Table 64.05. The area shall be provided with negative pressure relative to adjacent areas. An equal supply of outside air is required when the exhaust exceeds 1/2 air change per hour in the area served by the exhaust unless otherwise exempted under sub. (4).

(e) Areas assigned ventilation classification (e) shall be provided with a percentage of outside openings in accordance with sub. (3).

(f) Corridor areas in shopping malls assigned ventilation classification (f) do not require a separate supply of outside air provided the outside air introduced in the store areas adjacent to the mall is circulated through and exhausted from the shopping mall corridor area.

(3) **PERCENT OF OPENINGS.** Where the required ventilation is provided with a percent of openings, the net openable area of exterior windows and doors in each room shall be at least equal to the specified percent of the floor area of that room. Separate mechanical ventilation systems shall be provided for rooms with less than the required percent of openings.

(4) **EXCEPTIONS.** (a) *Outside air requirement waived.* If a mechanical air supply system is provided and the requirement for outdoor air determined in accordance with Table 64.05 is less than 5% of the minimum required air changes per hour determined in accordance with s. Comm 64.06 (2), the requirement for outside air may be eliminated.

(b) *Outside air requirement and percent of openings waived.* The requirement for outside air or percent of openings specified in Table 64.05 may be omitted for (a) or (b) ventilation classifications in large volume spaces containing 5,000 or more cubic feet per occupant.

(5) **DETERMINATION OF NUMBER OF PERSONS.** The number of persons in a given space shall be calculated using the net square feet per person given in Table 64.05 unless justification acceptable to the department is provided to show that a different number of occupants is reasonable. When the number of persons is not derived from Table 64.05, the number of occupants shall be documented. Where there is no value indicated for the net square feet per person in Table 64.05, the actual number of occupants shall be used to determine the required amount of outside air.

History: Cr. Register, March, 1997, No. 495, eff. 4-1-97.

TABLE 64.05
TEMPERATURE AND VENTILATION TABLE

Use or Occupancy ⁶	Ventilation Requirements						Applicable Occupancy Code Section (Comm Number)
	Minimum Inside Temperature (Degrees F)	Ventilation Classification	Basis of Capacity			Air Change Rate ⁹ Minimum Air Change Per Hour With A/C	
			O.A. - Mech. Net Sq. Ft. Per Person	O.A. - Nat. Percent of Openings ^{21.2}	Exhaust CFM/Net Square Feet Floor Area		
<i>Factories, office and mercantile buildings</i>							
Animal kennels	NMR	(d)	—	—	Note 3	—	64.54
Barber and beauty salons	67	(d)	—	—	0.50	—	64.54, 64.18
Canning factories	60	(b)	75	3	—	—	64.54, 64.68
Conference rooms	67	(a)	7	—	—	3	64.54
Court and jury rooms	67	(b)	6	3	—	3	64.54
Factories and machine shops	60	(b)	75	3	—	—	64.54
Flammable liquids storage	NMR	(d)	—	—	—	—	64.18, Comm 10
Foundries and boiler shops	50	(b)	75	3	—	—	64.13, 64.54
Funeral homes:							
Chapel	67	(b)	6	3	—	—	64.54
Embalming room	67	(d)	—	—	2.00	—	64.54
Offices	67	(a)	75	—	—	1.5	64.54
Places of worship, entertainment and recreation which accommodates less than 100 persons	†	(b)	—	3	†	—	64.54
Printing establishments	60	(a) or (d)	75	—	Note 8	3	64.18, 64.54
Retail establishments	67	(b)	60	3	—	1.0	64.54
Shopping mall corridor areas (except mercantile areas)	NMR	(f)	Aggregate capacity of stores served by mall	—	—	—	64.54
Security vaults (occupied)	67	(a)	300	—	—	—	64.54
Warehouses	NMR	—	—	—	—	—	64.18, 64.54
Dark room	67	(d)	—	—	2.00	—	64.54, 64.18
Smoking lounge	67	(d)	—	—	2.00	—	64.54, 64.18
Dry cleaners	67	(d)	—	—	2.00	—	64.54, 64.18
<i>Theaters and places of assembly (which accommodate more than 100 persons)</i>							ch. Comm15
Arenas and field houses (use seated area)	60	(a)	6	—	—	2	64.55

TABLE 64.05 - Continued

Use or Occupancy ⁶	Ventilation Requirements						Applicable Occupancy Code Section (Comm Number)
	Minimum Inside Temperature (Degrees F)	Ventilation Classification	Basis of Capacity			Air Change Rate ⁹ Minimum Air Change Per Hour With A/C	
			O.A. - Mech. Net Sq. Ft. Per Person	O.A. - Nat. Percent of Openings ^{21,2}	Exhaust CFM/Net Square Feet Floor Area		
Armory drill floors	55	(a)	30	—	—	—	64.55
Assembly halls (other than church)	67	(a)	6	—	—	2	64.55
Bowling alleys	67	(a)	15	—	—	2	Based on occupied areas
Cafeterias, dining areas, restaurants, billiard rooms	67	(a)	15	—	—	2	64.55
Places of worship:							
Chapels	67	(b)	6	3	—	—	64.55 (3)
Dining and social rooms	67	(b)	15	3	—	—	64.55 (3)
Nave or auditorium	67	(b)	6	3	—	—	64.55 (3)
Class rooms	67	(b)	20	3	—	—	64.55 (3)
Dance halls	67	(a)	15	—	—	2	64.55
Ice skating rinks (indoor)	NMR	(a)	15	—	—	—	64.55
Ice resurfacing (indoor)	NMR	(d)	—	—	—	—	64.18, 64.55
Lodge halls, club rooms	67	(a)	15	—	—	2	64.55
Roller skating rinks (indoor)	50	(a)	15	—	—	2	64.55
Bars and cocktail lounges	67	(d)	—	—	0.50	—	64.55
Tennis courts (indoor)	60	(a)	—	—	—	—	64.55
Theaters (seated area)	67	(a)	6	—	—	2	64.55
Lobbies	67	(a)	15	—	—	—	64.55
Lounge rooms	67	(a)	15	—	—	—	64.55
Motion picture booths	60	(a) or (c)	—	—	2.00	—	64.55
Smoking lounge	67	(d)	—	—	2.00	—	64.55, 64.18
Game rooms	67	(a)	15	—	—	2	64.55
Gambling casinos	67	(a)	15	—	—	2	64.55
<i>Health care facilities</i>							
					See Comm 64.57		
Schools or other places of instruction							
Administrative office space	67	(a)	75	—	—	1.5	64.56
Arts, crafts	67	(a)	30	—	—	2	64.56
Classrooms	67	(a)	20	—	—	2	64.56

TABLE 64.05 - Continued

Use or Occupancy ⁶	Ventilation Requirements						Applicable Occupancy Code Section (Comm Number)
	Minimum Inside Temperature (Degrees F)	Ventilation Classification	Basis of Capacity			Air Change Rate ⁹ Minimum Air Change Per Hour With A/C	
			O.A. - Mech. Net Sq. Ft. Per Person	O.A. - Nat. Percent of Openings ^{21,2}	Exhaust CFM/Net Square Feet Floor Area		
Ventilation Requirements							
Gymnasiums, field houses, auditoriums, theaters (fixed seats)	67	(a)	6	—	—	2	64.56
Bleachers	—	(a)	2.75 or 18"/person	—	—	2	64.56
Locker and shower rooms	70	(d)	—	—	2 or 35 cfm per locker	—	64.56
Gymnasiums, field houses, auditoriums, theaters (nonseated areas)	67	(a)	75	—	—	2	64.56
Home economics	67	(a)	30	—	—	2	64.56
(cooking)	67	(d)	—	—	Note 5	—	64.67
Laboratories (science)	67	(a)	30	—	—	2	64.18
Lecture halls	67	(a)	6	—	—	2	64.56
Corridors with lockers	67	—	—	—	—	10 cfm/lin- eal ft. of length	64.56
Library and resource centers	67	(a)	20	—	—	2	64.56
Reading rooms	67	(a)	20	—	—	2	64.56
Stack areas	67	(d)	—	—	0.25	—	64.56
Lunchrooms	67	(a)	10	—	—	1	64.56
Museums and art galleries	67	(a)	40	—	—	2	64.56
Music rooms (instrumental)	67	(a)	20	—	—	2	64.56
(vocal)	67	(a)	10	—	—	2	64.56
Special education	67	(a)	35	—	—	2	64.56
Study halls, common areas with non- fixed seating	67	(a)	10	—	—	2	64.56
Toilet rooms	67	(d)	—	—	Greatest of 2 or 75 cfm/TF	—	64.54
Vocational shops:							
With vehicle service and repair	60	(d)	—	—	0.75	—	64.18
Without vehicle service and repair	60	(a)	50	—	—	2	64.18
Wardrobes, coat rooms	NMR	(d)	—	—	2.00	—	64.65
<i>Detention facilities</i>							
Sleeping rooms (Note 7)	67	(b)	35	4	—	—	64.58

TABLE 64.05 – Continued

Use or Occupancy ⁶	Ventilation Requirements						Applicable Occupancy Code Section (Comm Number)
	Minimum Inside Temperature (Degrees F)	Ventilation Classification	Basis of Capacity			Air Change Rate ⁹ Minimum Air Change Per Hour With A/C	
			O.A. – Mech. Net Sq. Ft. Per Person	O.A. – Nat. Percent of Openings ^{21.2}	Exhaust CFM/Net Square Feet Floor Area		
Ventilation Requirements							
<i>Residential occupancies</i>							
Living and sleeping areas	67	(b)	Note 4	4	—	—	64.59
Day care facilities	67	(a)	35	—	—	2	64.60
<i>Garages and service stations¹⁰</i>							
Automobile showrooms:							
Less than 6 vehicles	60	(b)	75	3	—	—	64.64
6 or more vehicles	60	(d)	—	—	0.50	—	64.64
New vehicles only	60	(a)	75	—	—	1	64.64
Garages: less than 6 vehicles	NMR	(b)	—	3	—	—	64.63
Garages: 6 or more vehicles	NMR	(d)	—	—	0.50	—	64.63
Repair areas	60	(d)	—	—	0.75	—	64.61
Vehicle service buildings	60	(d)	—	—	0.50	—	64.62, 59.17
<i>General sanitation and service areas</i>							
Chlorine storage rooms	NMR	(d)	—	—	2.00	—	64.65
Janitor closets	NMR	(d)	—	—	2 or 50/sink	—	64.65
Locker rooms and shower rooms	70	(d)	—	—	2 or 35/locker	—	64.65
Toilet rooms	67	(d)	—	—	2 or 75/TF	—	64.65
Toilet rooms (with outdoor stadium)	50	(d)	—	—	2 or 75/TF	—	64.65
Coat rooms (walk in)	60	(d)	—	—	2.00	—	64.65
Locker and changing rooms with toxic contamination	70	(c)	—	—	2 or 35/locker	—	64.65, 64.54 & 54.13
Changing rooms without toxic contamination	70	(b)	15	3	0.50	1	64.65

TABLE 64.05 – Continued

Use or Occupancy ⁶	Ventilation Requirements						Applicable Occupancy Code Section (Comm Number)
	Minimum Inside Temperature (Degrees F)	Ventilation Classification	Basis of Capacity				
			O.A. – Mech. Net Sq. Ft. Per Person	O.A. – Nat. Percent of Openings ^{21,2}	Exhaust CFM/Net Square Feet Floor Area	Air Change Rate ⁹ Minimum Air Change Per Hour With A/C	
	Ventilation Requirements						
<i>Laundries (commercial)</i>	60	(d)	—	—	2.00	—	64.65
<i>Natatoriums</i>	76	(d)	—	—	2/pool sf	—	64.66
<i>Kitchens</i>	60	(d)	—	—	2.00	—	64.67
<i>Seasonal occupancies</i>							
Camps and lodges:							
Dining and recreational areas	NMR	(b)	15	3	—	—	64.68
Living and sleeping areas	NMR	(e)	—	4	—	—	64.68
Club houses	NMR	(b)	15	3	—	—	64.68
Drive-ins	NMR	(b)	15	3	—	—	64.68
Kitchens	NMR	(c) or (d)	—	—	2.00	—	64.67
Outdoor toilets	NMR	(d)	—	—	2.00	—	52.53 & 64.65

CFM = Cubic feet per minute
 LF = Lineal foot
 NMR = No minimum requirement
 TF = Toilet fixtures (water closets and urinals)
 A/C = Air conditioning

[†]See theaters and places of assembly for inside design temperature and cfm per net square feet floor area.

¹ See ss. Comm 64.06, 64.07 and 64.08 for mechanical, natural and exhaust ventilation systems; and ss. Comm 64.11 to 64.18 for ventilation air standards.

² See s. Comm 64.07 for special considerations on natural ventilation.

³ Temperature, humidity and air flow for animal kennels will depend on animal type.

⁴ 30 cfm of outside air shall be provided for each room. All other requirements for the (b) ventilation classification remain the same.

⁵ 200 cfm of exhaust ventilation per cooking appliance shall be provided. All other requirements for the (d) ventilation classification remain the same.

⁶ This Table is intended as a reference guide with generic Use types listed under those Occupancy types most often associated with the Use. When Use types are mixed between Occupancy types and the Use type is unlisted within the specific Occupancy Type, the use shall be ventilated as required by the same Use type listed in the other Occupancy type. Unlisted occupancies or uses shall be ventilated as required for the most similar listed occupancy or use acceptable to the department. Rooms that are used for different purposes at different times shall be designed for the greatest amount of ventilation required for any of the uses.

⁷ See ss. Comm 58.45(2) & 58.46(2) for more stringent requirements which may exist. When unseparated toilet fixtures are included in sleeping areas (such as cells), the room shall be ventilated as required for Toilet rooms.

⁸ In instances where the printing process involve inks or solvents which are volatile or otherwise toxic to humans, the (d) ventilation classification shall be used the exhaust rate shall not be less than 2 cfm/square foot of floor area.

⁹ See s. Comm 64.06 for specific requirements and exceptions which may exist. The minimum air change rate is 6 air changes per hour. The air change rates shown in the table are the rates permitted when air conditioning is provided in accordance with s. Comm 63.23 and the heat gain requirement for the space has been satisfied.

¹⁰ See ch. Comm 18, ASME A17.1 101.5b and s. Comm 64.18 (1) for machine room ventilation requirements.

Page intentionally left blank.

Comm 64.06 Mechanical ventilation systems.

(1) **OUTSIDE AIR.** Mechanical ventilation systems shall be operated to provide a continuous source of outside air to all areas while people are present. The minimum amount of outside air supplied to the system shall be determined in accordance with s. Comm 64.05. Exhaust ventilation in equal volume shall be maintained simultaneously.

Note: When less than one occupant per 5000 cubic feet is present, operation of the ventilation system may be modified as specified in s. Comm 64.05 (4).

(2) **AIR CHANGE.** Air change shall be provided while people are present. The air-change rate may be based on actual room height or up to 10 feet from the floor level of the room in question. The volume above 10 feet, in rooms which are more than 10 feet in height, need not be considered in the air change requirement if the required air change is designed to occur in the lower 10 feet of the occupied space. Where more than one room is served by a common supply system, the required minimum air change volume shall be transferred through the air handling equipment where it is diluted or replaced with outside air, and supplied back to the space. Where a supply system serves only one room, the required minimum air change may be achieved by circulation within the room at the required rate.

(a) *Six air changes per hour.* When required for (a) and (b) ventilation classifications, as specified in s. Comm 64.05, the total air change rate shall be at least 6 air changes per hour.

(b) *Less than 6 air changes per hour.* An air change rate of less than 6 air changes per hour will be permitted where mechanical cooling (air conditioning) is provided in accordance with s. Comm 63.23 (2), and the heat gain requirement for the space has been satisfied. The air-change rate may not be less than the minimum air changes per hour if specified in Table 64.05.

Note: The amount of outside air required by s. Comm 64.05 must be maintained even if the air change rate is reduced.

(c) *Air change requirement waived.* The air change requirement for 6 air changes per hour may be omitted in the following applications:

1. Spot heating.
2. Buildings where the requirement for outside air is waived in accordance with s. Comm 64.05 (4) (b).
3. Buildings utilizing percentage of openings as specified in s. Comm 64.05.

(3) **AIR DISTRIBUTION.** An adequate number of air supply, return and exhaust outlets or grilles shall be provided to insure a uniform distribution of air.

(4) **RECIRCULATION AND TRANSFER OF AIR.** (a) *Recirculation.* No air contaminated by any source other than human occupancy shall be recirculated, except within the same ventilation classification as assigned in s. Comm 64.05.

(b) *Transfer.* Air in a volume equal to the outside air required for a room may be transferred through a corridor and exhausted through a locker room, toilet room, kitchen, janitor closet or a similar area. Air shall not be transferred through elevator shafts and stairwells where doors are required at any floor level.

(5) **DIVERSIFIED MECHANICAL SYSTEMS.** If the mechanical ventilation system is able to deliver required quantities of outside air to each area when required, the department will recognize diversity and the system may be designed on the actual capacity.

Note: The outdoor air amounts specified in this section assume that the dominant source of indoor air contamination is human occupancy. Where other indoor contaminants or sources are present, source control or other control or removal strategies may be needed.

Note: See ch. Comm 32, Safety & Health Standards for Public Employees, for requirements for dust, fumes, vapors and gases.

History: Cr. Register, March, 1997, No. 495, eff. 4-1-97.

Comm 64.07 Natural ventilation system. (1) **OUTDOOR OPENINGS.** Outdoor openings used for natural ventilation shall be within 100 feet, or 5 times the least dimensional width of the occupied area, whichever is the least.

(a) *Outdoor openings located below grade.* Outdoor openings below grade will not be accepted unless there is a clear space outside of the opening having a width not less than 1 1/2 times the distance below grade at the bottom of the opening.

Note: Width of clear space is the horizontal distance measured at right angles to the plane of the opening.

(b) *Outdoor openings located from a property line.* Outdoor openings shall be at least 5 feet from a property line or lot line or both or an adjacent building on the same property. This distance restriction does not apply to property lines along streets.

Note: For further restrictions, see Table 51.03-B and s. Comm 64.19.

(2) **VESTIBULE OPENINGS.** Vestibule type openings may be used to satisfy the requirements specified in sub. (1) only for the areas of the building into which the vestibule opens and which are not separated from the vestibule by an additional door.

History: Cr. Register, March, 1997, No. 495, eff. 4-1-97.

Comm 64.08 Exhaust ventilation system. (1) **DEFINITIONS.** (a) *Exhaust ventilating system.* Any combination of building construction, machinery, devices or equipment, designed and operated to remove harmful gases, dusts, fumes or vitiated air from the breathing zone of employees and frequenters.

(b) *Gravity exhaust ventilation.* A process of removing air by natural means, the effectiveness depending on atmospheric condition, such as difference in relative density, difference in temperature or wind motion.

(2) **DESIGN.** (a) Exhaust ventilating systems shall be designed to reasonably prevent contaminated air from reentering the building.

(b) Mechanical exhaust ventilation shall be used when exhaust ventilation is required for toilet rooms, repair areas and garages except that gravity exhaust ventilation may be used for unoccupied, detached garages for long-term storage only.

(3) **OPERATION.** The required building exhaust ventilating systems shall operate continuously when people are in the building to provide the amount of exhaust specified in Table 64.05.

Note: Continuous operation of some exhaust systems, such as purging systems, chloride storage exhaust, or industrial exhaust, may be necessary. See ch. Comm 32, Safety & Health Standards for Public Employees.

(4) **EXHAUST VENTS.** All exhaust vents shall be ducted to the exterior of the building.

(5) **GRAVITY SIPHON-TYPE ROOF VENTILATORS.** (a) Except as provided in par. (b), gravity siphon-type roof ventilators shall be sized to provide a free area so that the velocity of the air does not exceed 300 feet per minute.

(b) The allowable velocity specified in par. (a) may be increased to 600 feet per minute provided the outside air is supplied by mechanical means.

Note: Heat reclaim equipment for exhaust systems having more than 10,000 CFM capacity should be considered for energy savings.

History: Cr. Register, March, 1997, No. 495, eff. 4-1-97.

Comm 64.09 Combustion air intakes. Any room in which fuel-burning equipment, including water heaters, fireplaces and process equipment, is located shall be supplied with combustion air for safe operation. When new heating equipment is installed in existing buildings, combustion air shall be provided in accordance with this section unless another method is shown to be adequate.

(1) **COMBUSTION AIR.** Combustion air shall be provided by one of the following methods:

(a) *Combustion air by gravitational means.* Where combustion air is introduced by gravitational means, the minimum free area for combustion air intakes shall be calculated in square inches as indicated in Table 64.09. The values for gas- and oil-fired equipment are based on the fuel input of the equipment. The value for solid-fuel equipment and fireplaces is based on the fuel input of the equipment, the area of the chimney connector or the listing for the specific piece of equipment. (See Table 64.09).

TABLE 64.09
Combustion Air Intake Areas

Atmospheric Combustion	Combustion Air Intakes Ducted from the Outside to an Interior Room or Fireplace	Combustion Air Intakes Located at the Outside Wall of an Exterior Room
Gas-fired, all occupancies except industrial	1 sq. in./1000 Btu/hr.	1 sq. in./2000 Btu/hr.
Gas-fired, industrial occupancies	1 sq. in./1000 Btu/hr.	1 sq. in./5000 Btu/hr.
Oil-fired, all occupancies	1 sq. in./1000 Btu/hr.	1 sq. in./2000 Btu/hr.
Solid-fuel fired equipment and fireplaces, all occupancies	1 sq. in./1000 Btu/hr. for furnace type units. 1/2 of the chimney connector area for free-standing and fireplace type units. In accordance with equipment listing, if listing includes combustion air provisions.	

(b) *Combustion air for power burners.* The free area for combustion air intakes for power burners, including forced draft and induced draft systems, shall be at least 0.5 square feet per 1,000,000 Btu per hour fuel input, with a minimum free area of 10 square inches.

(c) *Combustion air by mechanical means.* Combustion air furnished by mechanical systems, such as makeup air units, may be used when complete design data is submitted and approved by the department.

(d) *Combustion air by infiltration.* If the heating equipment is not required to be located in a fire-resistive room, combustion air may be provided by means of infiltration where the total area of outdoor openings is greater than 3% of the floor area in which the equipment is located, and where 150% of the air required for theoretical complete combustion is no greater than 1/4 air change per hour.

Note: See s. Comm 64.22 for special conditions.

(2) **DAMPERS.** (a) Manually operated dampers are prohibited in combustion air intakes, except for manually fired solid-fuel fired equipment, where the combustion air is connected directly to the equipment.

(b) A motorized damper or fire damper shall be permitted in combustion air intake if a means is provided to ensure that the damper is open before the burner is in operation.

(3) **DUCTWORK.** Where ductwork is required to bring combustion air into the building, the duct shall have the same cross-sectional area as the free area of the combustion air openings.

(4) **SEGREGATION OF COMBUSTION AIR.** The combustion air path shall be completely segregated from the outside air ventilation ductwork.

(5) **NEGATIVE PRESSURE LOCATIONS.** Atmospheric combustion shall be prohibited in a space under negative pressure.

(6) **MOUNTING HEIGHT.** Mounting height of the combustion air intakes shall be as required in s. Comm 64.19 (1) (c).

(7) **AIR-HANDLING EQUIPMENT LOCATED IN A BOILER OR FURNACE ROOM.** If the fuel input rating of the fuel burning equipment exceeds 400,000 Btu per hour, the air-handling equipment and the fuel-burning equipment shall be interlocked to shut off the fuel-burning equipment and the air-handling equipment when any service door of the air-handling equipment is opened, unless an air barrier separation is provided between the fuel-burning equipment and the air-handling equipment.

History: Cr. Register, March, 1997, No. 495, eff. 4-1-97.

Comm 64.10 Refrigerants. The rules covering the use of refrigerants for air conditioning systems shall conform with ch. Comm 45, Mechanical Refrigeration.

Subchapter III — Ventilation and Air Standards

Comm 64.11 Ventilation and air standards. The quantity of air used to ventilate a given space during periods of occupancy shall always be sufficient to maintain the standards of air distribution, air movement, recirculation, ss. Comm 64.13 to 64.19.

History: Cr. Register, March, 1997, No. 495, eff. 4-1-97.

Comm 64.13 Tempered air requirements. (1) SUPPLY AIR. The design conditions of the supply air temperature to the occupied space shall be between 50°F. and 140°F.

(2) **TEMPERED AIR SUPPLY DEPENDING ON NEGATIVE PRESSURE.** A supply of tempered air, depending on a negative pressure within the space, will be permitted in foundries, steel fabricating shops and similar areas.

History: Cr. Register, March, 1997, No. 495, eff. 4-1-97.

Comm 64.14 Tempered outside air requirements. (1) MAKE-UP AIR. A supply of tempered outside air shall be provided when the total volume of exhaust exceeds 1/2 air change per hour in the area served by the exhaust.

Note: See ch. Comm 32, Safety and Health Standards for Public Employees, for further requirements for makeup air for industrial exhaust systems.

(2) **PROCESS HEAT.** Process heat may be used to temper required outside air.

History: Cr. Register, March, 1997, No. 495, eff. 4-1-97.

Comm 64.15 Air movement and distribution. The air delivery capacity of all equipment supplying air for heating, ventilating and air conditioning purposes shall be based on standard air ratings.

Note: Standard air is substantially equivalent to dry air at 70°F. and 29.92 inches Hg barometric pressure.

History: Cr. Register, March, 1997, No. 495, eff. 4-1-97.

Comm 64.16 Air-cleansing devices. (1) AIR-CLEANSING ACCESS. Air-cleansing devices shall be designed and installed to permit access to the equipment for maintenance and to insure proper operation of the heating and ventilating system.

(2) **AIR-CLEANSING FILTERS.** Approved air-cleansing filters shall be designed and installed in a manner to filter the outside air and recirculated air used with mechanical heating and ventilating systems except as follows:

(a) Filters are not required in garages, factories, foundries and similar occupancies;

(b) Filters are not required for use with unit heaters designed for heating and recirculation; or

(c) Where jet systems or blend-air systems are approved, air filters are not required in the ducts that are installed for the recirculation of air within the same occupied space.

Note: The department recognizes as approved, filters listed in the Building Materials List published by Underwriters Laboratories, Inc., and test data of any other recognized testing agency for the purpose for which it is used.

(3) AIR-CLEANSING MATERIALS. Contaminated water shall not be used or recirculated through sprays affecting air used for ventilating purposes.

History: Cr. Register, March, 1997, No. 495, eff. 4-1-97.

Comm 64.17 Controls. (1) GENERAL. Except as provided in sub. (2), automatic controls shall be provided to maintain design temperature, control ventilation to provide a continuous air movement of not less than the minimum required by this chapter, and to provide a continuous supply of outside air, make-up air and exhaust determined by the provisions of s. Comm 64.05, when occupied.

(2) EXCEPTION. Manual control of solid-fuel fired equipment to maintain inside design temperature is permitted.

History: Cr. Register, March, 1997, No. 495, eff. 4-1-97.

Comm 64.18 Contamination of air. (1) CONTAMINATION. Air contaminated from odors, fumes, noxious gases, smoke, steam, dust, spray, or other contamination shall be diluted with uncontaminated air or exhausted to prevent the contaminated air from spreading to other parts of the building occupied by people.

Note: For requirements pertaining to all places of employment or occupancy where smoke, gas, dust, fumes, steam, vapor, industrial poisons, or other detrimental materials are used, stored, handled, or are present in the air in sufficient quantities to obstruct the vision, or to be injurious to the health, safety or welfare of the employees or frequenters, see ch. Comm 32, Safety and Health Standards for Public Employees.

(a) Chlorinated hydrocarbons. Areas where chlorinated hydrocarbons are introduced shall be arranged to satisfy the following conditions:

Note: Some of the chlorinated hydrocarbons commonly used are: trichloroethylene, perchloroethylene, carbon tetrachloride, methylene chloride, methyl chloroform, Freon F-11, Freon F-12, Freon F-21 and Freon F-114. For example, these materials are used in dry cleaning establishments, in degreasing operations, and where pressure can propellants are used. Pressure cans are used for such products as enamels, lacquers, paint removers, stencil inks, lubricants, pesticides, hair sprays, shaving lathers, shampoos and colognes.

1. The area shall have an exhaust system capable of maintaining a negative pressure within the enclosed area.

2. The volume and distribution of air movement within the area shall be such that the average threshold limit values of specific airborne contaminants are not exceeded.

Note: See ch. Comm 32, Safety and Health Standards for Public Employees.

3. No fuel-fired heating unit, with or without a heat exchanger, shall be located within this area, nor shall it recirculate air from this area.

4. The surface temperatures of any type of heating equipment used in these areas shall be below the temperature at which toxic materials may be released.

Note: Toxic materials are those covered in ch. Comm 32, Safety and Health Standards for Public Employees.

(b) Transfer of contaminated air. Air shall not be transferred from an area of greater contamination.

Note: The department will accept air transferred from: corridor to toilet room; corridor to cloak room or janitor closet; dining room to kitchen; locker room to toilet room; gymnasium to locker room; showroom to garage; and corridor to school vocational shops.

(c) Transfer of air between dwelling units. Air shall not be transferred from one dwelling unit to another, except in buildings where tobacco smoking is controlled and restricted to designated areas and not allowed in dwelling units, and air is not transferred from designated smoking areas to dwelling units.

(2) BATTERY CHARGING AREAS. Battery charging areas shall be provided with 3/4 cfm per square foot of outside air and equivalent exhaust unless calculations are submitted to verify that the concentration of hydrogen generated during battery charging will

be maintained below 1.5% by volume by other means. Exhaust air shall be drawn from the battery charging area at ceiling height.

History: Cr. Register, March, 1997, No. 495, eff. 4-1-97.

Comm 64.19 Location of outside ventilating air intakes or exhausts for mechanical ventilation systems.

(1) LOCATION AND DISTANCE. (a) Location to prevent contamination. Outside air intake openings for ventilation, doors, and openable windows shall be located to minimize contamination of outdoor air and shall be at least 10 feet, measured in any direction, from outlets that emit products of combustion and exhaust vents. Exceptions to this paragraph are given in subs. 1. to 4.

1. Exhaust vents of 100 cfm or less shall be located at least 12 inches, measured in any direction, from doors or openable windows.

2. Paragraph (a) does not apply to intakes for combustion air or short-cycle hoods.

3. The 10-foot minimum separation of par. (a) does not apply to the intake and exhaust of a factory-packaged rooftop unit provided nothing restricts air flow around the unit. The exhaust and intake of the unit shall be located to minimize contamination of outside air.

4. Product of combustion outlets of direct vent sealed combustion chamber appliance vents shall be located at least 12 inches, measured in any direction, from doors or openable windows.

Note: See s. Comm 82.31 (16) for plumbing vent setbacks. That rule requires plumbing vents to be 10 feet from air intakes and 10 feet horizontally from or 2 feet above roof scuttles, doors or openable windows.

Note: See NFPA 45, Standard on Fire Protection for Laboratories using Chemicals, for chemical fume hood exhaust location. Health care facilities may have additional requirements, see s. Comm 64.57.

(b) Distance to adjacent properties. Air intakes and exhausts shall be at least 10 feet from a property line or lot line or both or an adjacent building on the same property. This distance restriction does not apply to property lines along streets or alleys.

(c) Mounting height. The lowest side of outside air intake openings shall be located at least 12 inches above outside grade, above adjoining roof surfaces, or above the bottom of an areaway.

Note: The department will accept outside air intakes in areaways provided the minimum horizontal cross section of the areaway is equal to the free area of the opening, a grating is provided over the areaway with a free area equal to the required air intake, and the grating is designed for a minimum of 100 PSF live load. A guardrail, as defined in s. Comm 51.162, will be accepted in lieu of the grating.

(2) SCREENS. All outside air intake openings shall be provided with a device to prevent intake of foreign material of 1/2 inch size or larger.

(3) WEATHER PROTECTION. All outside air intake openings shall be protected against weather and water with a weatherproof hood or louvers.

(4) ACCESSIBILITY AND CLEANLINESS. All outside air intakes shall be easily accessible for cleaning and shall be kept clean and sanitary.

(5) DAMPERS. (a) Intake. All required outside air intakes serving tempered or heated spaces shall be equipped with a damper with automatic controls which will close the damper and prevent the intake of outside air into the building when the ventilating unit is not in operation. Barometric controls shall not be used for the damper.

(b) Exhaust. Exhaust openings serving tempered or heated spaces shall be provided with automatic or self-activating back-draft dampers to prevent the intake of outside air into the building when the exhaust units are not in operation. Commercial kitchen hood systems are exempt from this paragraph.

Note: See s. Comm 64.57 for additional requirements for the location of intakes and exhausts for hospitals and nursing homes. See the Administrative Plumbing Code, chs. Comm 82-86 for additional clearance requirements for plumbing vents.

History: Cr. Register, March, 1997, No. 495, eff. 4-1-97.

Subchapter IV — Heating Equipment Requirements

Comm 64.20 Equipment ratings and safety controls. (1) **TEST AND INSTALLATION STANDARDS.** All oil- and gas-fired heating equipment, electric heating equipment, solid-fuel heating equipment and accessory equipment or devices shall be tested and installed in accordance with standards recognized by the department. Department review and approval of input or output ratings or both are required when ratings are needed to satisfy s. Comm 64.03 or 64.09.

(2) **SAFETY CONTROLS.** (a) *General.* The complete safety control package for the heating and ventilating equipment shall comply with standards accepted by the department.

(b) *Limits and controls.* Oil and gas-fired heating equipment and electric heating equipment shall be equipped with primary (flame safeguard) safety controls, safety limit switches, and burners or electric elements that comply with standards accepted by the department.

Note: The department recognizes UL 296/Oil Burners, and UL 795/Commercial-Industrial Gas-Heating Equipment, as acceptable standards that satisfy the requirements of subs. (1) and (2).

(3) **LISTED EQUIPMENT.** Complete factory assembled heating units shall be labeled by listing agencies approved by the department.

Note: The department accepts heating equipment listed by the American Gas Association (AGA), Underwriters Laboratories (UL), ETL Testing Laboratories, Inchupe Testing Services NA, Inc., Warnock Hersey International, Inc., Braun Intertec Corp. (formerly Northwest Testing Laboratories, Inc.) and PFS corporation.

(4) **UNLISTED EQUIPMENT.** If the heating equipment is unlisted, the following provisions shall be taken:

(a) *Manufacturer's statement.* A statement from the equipment manufacturer shall be provided indicating the national standard with which the equipment complies.

(b) *Tests.* A test by a Wisconsin registered engineer shall be conducted on the output and safety controls, in accordance with the national standard used by the manufacturer. A statement regarding the test of the rating and safety controls shall be furnished for each installation unless an approval for the equipment is obtained from the department in accordance with sub. (5).

(5) **EQUIPMENT APPROVAL.** Equipment approval may be obtained from the department upon submission of a technical report, based on the test required in sub. (4) (b), together with the fee as specified in ch. Comm 2 for equipment approval.

Note: The purpose of the technical report is to show that the equipment is in complete compliance with the national standard by which the equipment is designed, constructed and tested.

History: Cr. Register, March, 1997, No. 495, eff. 4-1-97.

Comm 64.21 Location of equipment. (1) **GENERAL.** Heating equipment shall be installed in accordance with the limitations specified in Table 64.21.

Note: The footnotes after the table designate special requirements for the listed equipment.

Note: The department will accept net ratings as listed by the Mechanical Contractors Association of America, Inc., or the Institute of Boiler and Radiator Manufacturers.

(2) **CENTRAL FURNACES.** For the purpose of this section, a central furnace shall be considered as a direct vent sealed combustion chamber appliance if the furnace conforms to the requirements of ANSI standard Z21.47 for direct vent central furnaces.

(3) **BOILERS AND WATER HEATERS.** For the purpose of this section, a low-pressure boiler or a water heater shall be considered as a direct vent sealed combustion chamber appliance if the boiler or water heater conforms to those parts of ANSI standard Z21.13, Z21.10.1, or Z21.10.3, whichever is applicable, relating to direct vent appliances.

History: Cr. Register, March, 1997, No. 495, eff. 4-1-97; r. and recr. Register, September, 2000, No. 537, eff. 10-1-00.

Table 64.21 - LOCATION OF EQUIPMENT¹⁹

Location and Type of Occupancy	Vented Units							Unvented Units		Electric	Water or Steam	
	Gas or Oil or Solid Fuel Boilers	Gas or Oil or Solid Fuel Furnaces and Water Heaters		Gas or Oil Unit Heaters	Gas or Oil Infrared		Gas or Oil Space Heater ¹	Solid Fuel Space Heater ^{1,2}	Gas Direct Fired Make-up Air ^{3,4}	Gas Infrared	Furnaces, Unit Heaters, Heat Pumps, Baseboard Heaters, etc.	Unit Ventilators, Heaters, Make-Up Air Units, Baseboard Heaters, etc.
		Suspended ⁵	Suspended ⁵		Closed Combustion Infrared Equipment with Surface Temperatures not Exceeding 1500°F	Open Flame Infrared Equipment with Surface Temperatures Exceeding 1500°F						
Factories	Yes ⁵	Yes ⁵	Yes	Yes	Yes	Yes	Yes	Yes	Yes	Yes		
Mercantile Buildings	Yes ⁵	Yes	Yes	Yes	Yes	Yes	N.P. ^{5,6}	N.P. ⁶	N.P.	N.P.		
Office Buildings	Yes ⁵	Yes	Yes	Yes	Yes	N.P.	N.P. ^{5,6}	N.P. ⁶	N.P.	N.P.		
Places of assembly, entertainment, recreation, worship or dining (100 persons or less)	Yes ⁵	Yes	Yes	Yes	Yes	Yes	N.P. ^{5,6}	N.P. ⁶	N.P. ⁷	N.P.		
Tennis Facilities (court areas only)	Yes ⁵	Yes	Yes	Yes	Yes	Yes	N.P. ^{5,6}	N.P. ⁶	N.P.	N.P.	Permitted in all Occupancies	Permitted in all Occupancies
Tennis Facilities (all other areas)	Yes ⁵	Yes	Yes	Yes	Yes	N.P.	N.P. ^{5,6}	N.P. ⁶	N.P.	N.P.		
Theaters and places of assembly, entertainment, recreation, worship or dining (more than 100 persons)	Yes	Yes	Yes	Yes	Yes	N.P.	N.P.	N.P.	N.P.	N.P.		
Restaurants	Yes	Yes	Yes	Yes	Yes	N.P.	N.P.	N.P.	N.P. ⁷	N.P.		
Type of Occupancy												
Tennis Facilities (court areas only)	Yes	Yes	Yes	Yes	Yes	Yes	N.P.	N.P.	N.P.	N.P.		
Tennis Facilities (all other areas)	Yes	Yes	Yes	Yes	Yes	N.P.	N.P.	N.P.	N.P.	N.P.		
Schools and other places of Instruction	Yes	Yes ²⁰	Yes	Yes	Yes	N.P. ¹⁰	N.P.	N.P.	N.P. ⁹	N.P.		
Hospitals, Nursing Homes and Penal Institutions	Yes	Yes ²⁰	N.P.	N.P.	N.P.	N.P.	N.P.	N.P.	N.P.	N.P.	Permitted in all Occupancies	Permitted in all Occupancies
Residential Occupancies	Yes	Yes	N.P.	N.P.	N.P.	N.P.	N.P. ¹¹	N.P. ¹⁴	N.P.	N.P.		
Hazardous Occupancies												
Garages	Yes	Yes	Yes ¹²	Yes ¹²	Yes	Yes	N.P. ¹⁵	N.P.	Yes ¹²	Yes ¹²		
Aircraft Hangers	Yes	Yes	Yes ¹³	Yes ¹³	Yes ¹³	Yes ¹³	N.P.	N.P.	Yes ¹³	Yes ¹³		
Day Care Centers	Yes	Yes	Yes	Yes	Yes	N.P.	N.P. ⁶	N.P. ⁶	N.P.	N.P.		
Community-Based Residential Facilities ¹⁷	Yes	Yes	N.P.	N.P.	N.P.	N.P.	N.P. ⁶	N.P. ⁶	N.P.	N.P.		

N.P. = Not Permitted

Unlisted Occupancies -- Use the listed occupancy in the table that is most similar to the subject occupancy.

Clearance to combustibles and combustible construction. 1. Heating equipment shall be installed in accordance with the manufacturer's recommendations to provide minimum clearance. In the absence of manufacturer's recommendations, a minimum clearance of 36 inches shall be provided. 2. Combustible construction, such as partitions, shelving or storage lockers, shall not encroach upon the required clearance.

Note: Electrical Code clearances specified in ch. Comm 16 apply. Electrical components and burners may be required to be at least 18 inches from the floor in "Class I" areas including garages.

¹ See s. Comm 64.22 (7) (d) for fireplace requirements.

² All solid-fuel fired space heaters shall be located in occupied space or in a space provided with approved smoke detectors and located or guarded to maintain clearances to combustibles and prevent accidental damage or contact with hot surfaces. Solid-fuel burning stoves are limited to 150,000 Btu/hr output.

³ Except as provided in Footnote 4, direct-fired make-up air units shall be mechanically exhausted in the range of 90% to 110% of the air supplied.

⁴ See s. Comm 64.22 (4) for other permitted uses of direct-fired unvented natural gas heaters.

⁵ Boilers, water heaters, gas and liquid fuel-fired space heaters, suspended furnaces, vented and unvented unit heaters may be suspended where approved by the department. Except in factories, suspended boilers and water heaters shall be limited to up to 200,000 Btu input. All such units shall be located in an occupied space and suspended at least 7 feet above the floor. The blow-off pipe for suspended boilers and water heaters shall be extended down to within 6 inches of the floor. Infrared equipment shall be located at least 8 feet above the floor. Suspension of solid-fuel fired equipment is not permitted. See ss. Comm 51.08 and 64.22 (3) for additional requirements.

⁶ Permitted with combustion air ducted to unit in occupancies less than 3,000 square feet gross area and with occupant load less than 100 persons.

⁷ Permitted in kitchens to provide make-up air for kitchen exhaust systems if located outside building or in a rated enclosure.

⁹ Permitted only in shops with a 3-hour separation from other areas of the school building. See s. Comm 51.08.

¹⁰ Permitted only in shops with a 3-hour separation from other areas of the school building. See s. Comm 51.08.

¹¹ Gas-fired, direct-vent wall furnaces are permitted in apartments and motels. Space heaters fired with liquid fuel may be used without an enclosure in motels and apartment buildings not more than one story in height.

¹² Suspended heating units are allowed in garages if located at least 8 feet off the floor. Suspension of solid-fuel fired equipment is not permitted.

¹³ Suspended heating units are allowed if located at least 10 feet above the upper surface of the wings or engine enclosure of the aircraft. Suspension of solid-fuel fired equipment is not permitted.

¹⁴ Solid-fuel fired space heaters are permitted in rowhouse units only.

¹⁵ Waste oil burners are permitted provided they are installed on mezzanines or service platforms located at least 8'-0" above the main floor, are visible from the main floor and are guarded as specified in this section.

¹⁷ See s. Comm 61.24 for requirements.

¹⁹ See s. Comm 51.08 for hazard enclosure requirements.

²¹ Includes water heaters used for space heating and for plumbing system supply.

Comm 64.22 Special requirements. (1) BOILERS AND PRESSURE VESSELS. (a) *Construction standards.* Boilers and pressure vessels shall be constructed and installed in compliance with the standards of the American Society of Mechanical Engineers, as adopted under chs. Comm 41 to 42.

(b) *Installation notification.* The installing contractor shall notify the department of boiler installation, in accordance with the requirements of s. Comm 41.41 (1), before the boiler or pressure vessel is put into operation.

(2) **FURNACES.** Forced-air heating systems shall be designed to prevent a negative pressure on the heat exchanger.

(3) **SUSPENDED EQUIPMENT.** (a) Equipment suspended as specified in s. Comm 64.21 shall be installed in an occupied space. Suspended equipment may be used in multiple tenant buildings providing the equipment is located in tenant spaces of an occupancy use where suspended equipment is permitted. The equipment shall be visible to persons within the room.

(b) Suspended units shall be designed and listed for such use. Furnaces designed for floor mounting only may be mounted on platforms that serve only to hold the unit.

(c) Where the clearance to the floor specified in s. Comm 64.21 cannot be provided for suspended units, provisions shall be made for maintaining clearances to combustibles and collision protection. The collision protection shall be capable of withstanding a horizontal impact load of 1,000 pounds per lineal foot. The unit shall be visible to the occupants of the room. The unit shall be suspended to provide a minimum clearance of 18 inches from the floor. The minimum clearances specified by the manufacturer shall also be provided.

(d) In factories, where the clearance to the floor specified in s. Comm 64.21 cannot be provided, a floor mounted unit may be used in accordance with this paragraph. Provisions shall be made for maintaining clearances to combustibles and collision protection. The collision protection shall be capable of withstanding a horizontal impact load of 1000 pounds per lineal foot. The unit shall be visible to the occupants of the room. The unit shall be installed to provide a minimum clearance of 18 inches from the floor to the burner. The minimum clearances specified by the manufacturer shall also be provided.

Note: See Electrical Code, Ch. Comm 16, for clearance requirements for electrical components in hazardous locations.

(e) Duct furnaces and unit heaters required to be suspended under s. Comm 64.21 may be installed in an unoccupied or concealed space without a rated enclosure providing the following conditions are met:

1. The appliance complies with the requirements for separated combustion appliances as specified in ANSI Z83.8 or Z83.9, whichever is applicable; and

2. The unit is properly suspended and clearances to combustibles are maintained as specified in the manufacturer's listing.

(4) **GAS OR OIL-FIRED RADIANT HEATERS AND DIRECT FIRED UNVENTED NATURAL GAS HEATERS.** Gas- or oil-fired radiant heaters and direct fired unvented natural gas heaters are subject to the following provisions:

(a) The heaters shall be equipped with an automatic pilot of the complete shutoff type or with a 100% shutoff electric ignition;

(b) If unvented radiant heaters or direct fired unvented natural gas heaters are used, mechanical means shall be provided to supply at least 4 cfm of outside air per 1000 Btu per hour input of installed heaters;

(c) The amount of air supplied which exceeds the building's designed infiltration rate shall be relieved through relief openings or interlocked power exhaust. Relief openings may be louvers, gravity siphon-type roof ventilators, counterbalanced gravity dampers or motorized dampers provided the motorized damper is interlocked with the supply fan so as not to permit blower operation until the damper is proved in the open position.

(d) Oil-fired radiant heaters shall be equipped with mechanical pressure-atomizing burners; and

(e) Direct fired unvented natural gas heaters shall comply with ANSI Z83.18.

(5) **SPACE HEATERS.** Space heaters shall comply with the following provisions:

(a) The burner of the appliance shall be enclosed with a metal housing so constructed that there will be no open flame and the burner housing shall be effectively guarded against personal contact. The arrangement shall be such that the shield will prevent any combustible material in the vicinity of the appliance from coming in contact with the flame or with the housing that encloses the burner. Oil-fired space heaters shall be equipped with a mechanical pressure atomizing burner; and

(b) Space heaters shall not be equipped with duct extensions beyond the vertical and horizontal limits of the metal enclosure.

(c) The use of unvented fuel-fired space heating equipment shall be prohibited except for the equipment types and occupancies specified in Table 64.21.

(6) **EQUIPMENT IN HAZARDOUS LOCATIONS.** The types of heating and ventilating equipment that may be installed in hazardous locations (as defined in Article 500 of the National Electrical Code as adopted by reference in ch. Comm 16) are as follows:

(a) Listed low-pressure steam or hot water unit heaters and makeup air units; and

(b) Listed electric units.

(7) **FIREPLACES AND FIREPLACE STOVES.** Masonry fireplaces, factory-built fireplaces and factory-built fireplace stoves shall be constructed and installed in accordance with the NFPA standard No. 211—Standard for Chimneys, Fireplaces and Vents.

(a) *Masonry fireplaces.* 1. Masonry fireplaces shall be constructed of solid masonry units, stone or reinforced portland or refractory cement concrete.

a. Where a lining of low-duty firebrick complying with the provisions of ASTM C 64, or the equivalent, at least 2 inches thick laid-in fire-clay mortar complying with the provisions of ASTM C 105, or the equivalent, or other approved lining is provided, the total thickness of back and sides, including the lining, shall be not less than 8 inches.

b. Where the lining described in subd. 1. a. is not provided, the thickness of back and sides shall be not less than 12 inches.

2. Steel fireplace units incorporating a firebox liner of not less than 1/4 inch thick steel and an air chamber shall be installed with masonry to provide a total thickness at the back and sides of not less than 8 inches, not less than 4 inches of which shall be solid masonry.

3. Warm air ducts employed with steel fireplace units of the circulating air type shall be constructed of metal or masonry.

4. Fireplace hearth extensions of approved noncombustible material for all fireplaces shall be provided.

a. Where the fireplace opening is less than 6 square feet, the hearth extension shall extend at least 16 inches in front of, and at least 8 inches beyond each side of the fireplace opening.

b. Where the fireplace opening is 6 square feet or larger, the hearth extension shall extend at least 20 inches in front of, and at least 12 inches beyond each side of the fireplace opening.

c. Where a fireplace is elevated above or overhangs a floor, the hearth extension shall also extend over the area under the fireplace.

d. Fireplaces constructed of masonry or reinforced portland or refractory cement concrete shall have hearth extensions of brick, concrete, stone, tile or other approved noncombustible material properly supported and with no combustible material against the underside thereof. Wooden forms or centers used during the construction of hearth and hearth extension shall be removed when the construction is completed.

5. All wood beams, joists and studs shall be trimmed away from fireplaces. Headers supporting trimmer arches at fireplaces shall be not less than 20 inches from the face of the chimney breast.

Note: Trimmers shall be not less than 6 inches from the inside face of the nearest flue lining.

6. Woodwork shall not be placed within 4 inches of the back face of a fireplace.

7. Woodwork shall not be placed within 6 inches of a fireplace opening. Woodwork above and projecting more than 1 1/2 inches from a fireplace opening shall not be placed less than 12 inches from the top of a fireplace opening.

(b) *Factory-built fireplaces and fireplace stoves.* Factory-built fireplaces and fireplace stoves shall be installed according to the requirements of the approval as specified in s. Comm 64.20.

(c) *Hearth opening protection.* Fireplaces and fireplace stoves shall be equipped with safety screens or glass doors to prevent the escape of sparks and embers.

(d) *Permitted installations.* Fireplaces are permitted in the following applications.

1. In all occupancies within the scope of chs. Comm 54 and 55;

2. In health care facilities as specified in s. Comm 58.24 (2);

3. In common use areas of residential occupancies; and

4. In individual living units of residential occupancies except that fireplaces in individual living units of hotels and motels shall comply with the following:

a. The appliance shall be gas-fired and shall be tested and installed in accordance with standards recognized by the department.

Note: ANSI Z21.50 and ANSI Z32.60 are recognized by the department. See s. Comm 64.20(3) for listing requirements.

b. The appliance shall be designed to be ignited by an intermittent ignition device.

c. The fire box shall be provided with a permanently installed glass partition to prevent access to the fire box and appliance. The partition shall be designed to be compatible with the appliance listing.

Note: Operation of the appliance via a control located outside the fire box will be necessary.

d. Outside air shall be provided for combustion in accordance with s. Comm 64.09. Combustion air shall not be provided via infiltration.

(8) *FLOOR-STANDING VENTED OR UNVENTED EQUIPMENT.* Floor-standing, vented or unvented unit heaters, furnaces and boilers in metal fabricating plants, foundries and machine shops are exempt from the requirements of s. Comm 51.08.

(9) *HEAT EXCHANGER CORROSION PROTECTION.* If the entering air to the heat exchanger of all gas-fired equipment is 30°F or lower, the heat exchanger and burners shall be constructed of corrosion-resistive materials.

(10) *WATER HEATERS USED FOR SIMULTANEOUS SPACE HEAT AND HOT WATER SUPPLY FOR PLUMBING SYSTEM.* (a) *Water heater construction standards.* Water heaters that provide simultaneous space heat and hot water supply for a plumbing system shall be listed for compliance with ANSI Z 21.10.1 or ANSI Z 21.10.3 and be specifically designed for such use. The water heater shall have an input rating of 100,000 Btu/h or less.

(b) *Heat exchanger unit.* Heat exchanger units that are part of the plumbing system shall meet the requirements of Chs. Comm 82-84.

(c) *Sizing.* The water heater shall be sized with a sufficient capacity to simultaneously offset the heat loss at design temperatures and meet the other system demands it serves. The design recovery rate of the water heater shall be less than one hour for the hot water load for plumbing at design temperatures.

Note: See ch. Comm 84 for additional requirements for water heating equipment and s. Comm 63.20 for energy conservation requirements.

(11) *PROCESS EQUIPMENT.* Section Comm 64.21 does not apply to process equipment unless the equipment provides water supply for a plumbing system or provides space heating, exclusive of waste heat.

History: Cr. Register, March, 1997, No. 495, eff. 4-1-97; corrections in (7) (d) 2, and (8) made under s. 13.93 (2m) (b) 7., Stats., Register, November, 1999, No. 527; am. (8), Register, March, 2000, No. 531, eff. 4-1-00; am. (3) (e) 1., Register, September, 2000, No. 537, eff. 10-1-00.

Comm 64.23 Piping. (1) PIPE SIZES AND ARRANGEMENT. All supply and return piping carrying steam, hot water or other fluids, air-line piping and auxiliary equipment shall be of appropriate sizes, elevations and arrangements to accomplish the calculated services in practical operation, without undue noise, stress or other detriment.

(2) *EXPANSION AND CONTRACTION.* The piping for the heating system shall be equipped with anchors, expansion swings or joints, supports and similar devices to relieve stress and strains caused by temperature change of the pipe material.

(3) *PIPE INSULATION.* All supply and return piping carrying steam, hot water or other fluids shall be covered with insulating material where the pipes pass through occupied areas and the surface temperature exceeds 180°F., unless guarded.

(4) *PIPE PROTECTION.* No pipe carrying hot water, steam, or other fluid at a surface temperature exceeding 250°F. shall be placed within one inch of any woodwork, pass through a combustible floor, ceiling or partition, unless the pipe is protected by a metal tube one inch larger in diameter than the pipe or with approved pipe covering.

(5) *GAS OR OIL INSTALLATIONS.* (a) *Piping installations.* All gas piping and all oil piping shall comply with the following standards:

1. National Fuel Gas Code, NFPA No. 54; or

2. Installation of Oil-Burning Equipment, NFPA No. 31.

(b) *Oil tank installation.* Oil tanks serving oil-burning equipment shall be installed in accordance with ch. Comm 10.

History: Cr. Register, March, 1997, No. 495, eff. 4-1-97.

Subchapter V — Air Delivery Systems

Comm 64.31 Duct design. All ducts shall be designed to promote the unrestricted flow of air.

Note: The department will accept air duct velocities designed in accordance with the standards of the ASHRAE Handbook of Fundamentals, published by the American Society of Heating, Refrigerating and Air Conditioning Engineers.

History: Cr. Register, March, 1997, No. 495, eff. 4-1-97.

Comm 64.32 Duct use. No duct designed for the transmission of air shall be used for any other purpose.

History: Cr. Register, March, 1997, No. 495, eff. 4-1-97.

Comm 64.33 Underground duct construction and installation. (1) MATERIALS. (a) *Tile ducts.* All underground duct systems using cement tile, glazed clay tile and other tile having a composition of cement and mineral shall be waterproof and shall have sufficient strength to prevent failure of duct at the time of installation and while in service. All fittings shall be designed with bell and spigot or slip-joint connections. All joints shall be waterproof.

(b) *Plastic and metal ducts.* Metal, plastic-coated metal ducts, and other approved materials may be used for underground systems if encased in not less than 2 inches of concrete. The ducts shall be waterproof, noncombustible, smooth and of sufficient strength to prevent collapse. The sealing material for fittings and joints shall be approved by the department.

1. 'Exception.' Solid polyvinyl ducts and fittings and polyvinyl chloride (pvc)-clad metallic ducts and fittings need not be encased in concrete provided the space around the ducts and fittings is backfilled with sand or similar fill material.

(2) *DUCT INSULATION.* All underground ducts shall be insulated as specified in s. Comm 63.29.

(3) **DUCT DRAINAGE.** Underground ducts shall be provided with drainage to a lower room of the building or to a sump. No duct shall be connected to a sewer.

(4) **DUCT INLETS AND OUTLETS.** A water-tight connection shall be provided where the inlet and outlet risers are connected to underground ducts.

(5) **PIPING.** Nonhazardous piping may be installed in underground ducts if it does not restrict the air flow.

History: Cr. Register, March, 1997, No. 495, eff. 4-1-97.

Comm 64.34 Duct construction. (1) METAL DUCTS. All sheet metal ducts, duct liners and fittings shall be constructed in compliance with standards approved by the department.

Note: The department will accept the standards for ducts in the ASHRAE Handbook of Equipment Volume, published by the American Society of Heating, Refrigerating and Air Conditioning Engineers, or as illustrated in the HVAC Duct Construction Standards, Metal and Flexible and HVAC Air Duct Leakage Text Manual as published by the Sheet Metal and Air Conditioning Contractors National Association, Inc.

(2) **COMBUSTIBLE DUCTS.** All ducts or airways of wood or other combustible building elements shall be lined with sheet metal or other approved noncombustible material unless specifically exempted by this code.

(3) **NONMETALLIC DUCTS.** Coated metal ducts or ducts constructed of other than metal shall conform to the following:

(a) The method for fabricating, installing and supporting ducts shall be approved by the department;

Note: The department accepts Class 1 air ducts tested (Standards for Safety, UL 181) and listed by Underwriters' Laboratories, Inc., and constructed in accordance with fibrous glass duct construction standards published by the Sheet Metal and Air Conditioning Contractors National Association, Inc.

(b) The ducts shall resist puncture, deformation or collapse;

(c) The ducts shall not be used where the air temperature exceeds 250°F in fume hood exhaust ducts or for kitchen hood supply or exhaust ducts. Nonmetallic or coated metal ducts may be used to convey solids or corrosive gasses if information is provided to show the duct is suitable for the specific use and approval is granted by the department.

(d) The ducts shall not pass through required fire-resistive construction.

(4) **ADDITIONAL DUCT SEALING.** In addition to requirements of standards specified in sub.(1), where supply ductwork and plenums that are designed to operate at static pressures from 0.25 inches to 2 inches water column inclusive are located outside of the conditioned space or in return plenums, joints shall be sealed in accordance with Seal class C as defined in the SMACNA HVAC Duct Leakage Test Manual. Pressure sensitive tape shall not be used as the primary sealant where such ducts are designed to operate at static pressures of 1 inch water column or greater.

History: Cr. Register, March, 1997, No. 495, eff. 4-1-97.

Comm 64.35 Duct connectors. (1) FLEXIBLE DUCT CONNECTORS. Flexible duct connectors between duct systems and air outlets or air outlet units shall conform to the following:

(a) The duct material shall be approved for such use;

Note: Flame-retarded fabric or metal or mineral listed in the Building Materials List, published by Underwriters' Laboratories, Inc., are acceptable.

(b) The construction shall be approved by the department;

(c) The connector shall not be subject to deterioration from mildew or moisture; and

(d) The connector shall not pass through required fire-resistive construction.

(2) **VIBRATION CONTROL.** Vibration isolation connectors at the joint between the duct and fan or heat-producing equipment shall conform to the following:

(a) Connectors shall be a type approved for such use;

Note: Flame-retarded fabric or metal or mineral listed in the Building Materials List, published by Underwriters' Laboratories, Inc., are acceptable.

(b) Connectors shall be not more than 10 inches wide; and

(c) Connectors shall not be used where the air temperature is in excess of 250°F.

History: Cr. Register, March, 1997, No. 495, eff. 4-1-97.

Comm 64.36 Vertical shafts. Every vertical shaft shall be enclosed with noncombustible material which is fire-resistive rated in accordance with Table 51.03-A.

History: Cr. Register, March, 1997, No. 495, eff. 4-1-97.

Comm 64.37 Insulation. Heating supply ducts and pipes shall be covered with insulation unless an allowance is made for temperature drop in the system.

Note: Also see s. Comm 63.29 for additional requirements.

History: Cr. Register, March, 1997, No. 495, eff. 4-1-97.

Comm 64.38 Gravity ventilation ducts. (1) DESIGN. Horizontal runs in gravity ventilation ducts connected to siphon-type roof ventilators shall be avoided wherever possible and the maximum practicable inclination shall be provided in all cases. In no case shall the horizontal run exceed 30% of the vertical run unless the room has a mechanical supply of air or the ventilation duct is connected to an exhaust fan.

(2) **SEPARATE DUCTS.** Separate gravity ventilation ducts, from each area of similar occupancy, shall extend to a plenum at the base of a siphon ventilator.

(3) **PLENUMS.** Gravity ventilation ducts, used with mechanical ventilation supply systems, shall not terminate in an attic plenum unless the plenum is airtight, of noncombustible construction, and the attic floor is smooth. All collecting plenums shall be connected to an approved siphon-type roof ventilator or to an exhaust fan discharging outside the building.

(4) **DAMPERS.** Dampers are prohibited in gravity ventilation ducts, except atmospheric back-draft dampers are permitted.

History: Cr. Register, March, 1997, No. 495, eff. 4-1-97.

Comm 64.39 Ventilation discharge. All gravity and mechanical ventilation ducts shall be protected from the weather and shall be located and constructed to prevent contamination of an outside air supply. Gravity ventilation ducts shall extend not less than 2 feet above the highest portion of the building within a 10-foot radius of the duct and shall be provided with an approved type of siphon roof ventilator.

History: Cr. Register, March, 1997, No. 495, eff. 4-1-97.

Comm 64.40 Relief vents. (1) BAROMETRIC RELIEF VENTS PERMITTED. The use of barometric relief vents is permitted for type (a) and (b) ventilation classifications designated in s. Comm 64.05. Where barometric relief vents are installed on the roof, the discharge openings shall be not less than 2 feet above the roof surface where the vent pierces the roof.

(2) **BAROMETRIC RELIEF VENTS PROHIBITED.** The use of barometric relief vents is prohibited for type(c),(d) and(e) ventilation classifications designated in s. Comm 64.05.

History: Cr. Register, March, 1997, No. 495, eff. 4-1-97.

Comm 64.41 Plenums. (1) GENERAL. Plenums used for the supply, return or transfer of air shall be of noncombustible construction.

(a) **Exception.** Combustible ceiling materials may be used provided they comply with the following:

1. The ceiling material is made from a base material of metal or mineral;

2. All surfaces of ceiling material possess a flame-spread rating of not over 25 without evidence of continued progressive combustion and with a smoke-developed rating of not higher than 50;

3. The ceiling material is supported by noncombustible material having a melting point above 1400°F.(760°C); and

4. The ceiling material is not subject to deterioration or deformation on long exposure to temperatures of 250°F.(121°C) or under conditions of high humidity, excessive moisture, or mildew.

(b) *Ceiling systems with fire-resistive ratings.* Return air plenums shall not be placed in rated ceiling systems unless specifically allowed by the listing.

Note: This section permits the use of steel, painted steel bar joists and metal decking, concrete, plaster, and other noncombustible materials and restricts the use of certain combustible materials within air-handling plenums.

Note: The requirements for ceiling materials are based upon the National Fire Protection Association (NFPA) standard 90A, section 2-2.1.3.

(2) **DUCTWORK WITHIN THE PLENUM.** Ducts within the plenum shall be constructed of metal in accordance with s. Comm 64.34 (1) or approved nonmetallic materials in accordance with s. Comm 64.34 (3).

(3) **DUCT CONNECTORS.** Duct connectors shall comply with the requirements of s. Comm 64.35.

Note: Flame-retardant fabric or metal or mineral listed in the Building Materials List, published by Underwriters' Laboratories, Inc., are acceptable.

(4) **INSULATING MATERIALS WITHIN THE PLENUM.** (a) *Duct and pipe insulation.* Duct and pipe insulation, including coverings, linings, tapes and core materials, shall have a flame-spread rating of not over 25 without evidence of continued progressive combustion, and a smoke-developed rating no higher than 50 when tested according to ASTM E-84 standard tests.

Note: If coverings and linings are to be applied with adhesives, they shall be tested as applied with such adhesives, or the adhesives used shall have a flame-spread rating not over 25 and a smoke-developed rating no higher than 50 when in the final dry state.

(b) *Building envelope insulation.* Building envelope insulation within the plenum space shall have a flame-spread rating of 25 or less and a smoke-developed rating of 50 or less when tested according to ASTM E-84 test standards. The use of foam plastics, satisfying the requirements of s. Comm 51.06, for envelope insulation is permitted provided the foam plastic is protected by a thermal barrier as specified in s. Comm 51.06 (3).

(5) **HAZARDOUS PIPING.** The installation of hazardous piping as defined in s. Comm 51.01 (102) is prohibited in the plenum space, except as permitted under NFPA 54.

(6) **OPENINGS.** Openings into the plenum that would affect the fire-resistive rating of the structural component or system are prohibited.

(7) **WIRING AND CABLES.** Electric wiring, including low-voltage wiring, and telephone cables within the plenum space shall be installed according to the Wisconsin State Electrical Code, Vol. 2, ch. Comm 16.

(8) **PLUMBING.** Plumbing within the plenum shall be of noncombustible material.

(a) *Exception.* Plastic plumbing pipe and fittings may be used provided the plastic material is of the self-extinguishing type with an average extent of burn not greater than 10 mm and an average time of burn not greater than 20 seconds when tested according to ASTM D-635. The plastic material shall be wrapped with at least one inch of noncombustible insulation or enclosed with 1/2 inch type X gypsum wallboard.

(9) **CONTROL TUBING.** Plastic control tubing shall have an average extent of burn not greater than 10 mm and an average time of burn not greater than 20 seconds when tested according to ASTM D-635.

(10) **SMOKE DETECTION.** (a) *New construction.* Air-handling plenums which contain ductwork, duct connectors, insulation, plumbing or control tubing which do not meet the requirements of subs. (2) to (4), (8) and (9), respectively, shall be provided with an approved smoke detection system capable of stopping the air flow in and from the plenum and giving an audible alarm in the occupied area when activated.

(b) *Existing construction.* When existing plenum construction contains combustible insulation, wiring, plumbing or control tubing, and is altered or added to according to s. Comm 50.03 (1) or (2), the entire plenum space, new and existing, shall be provided with a smoke detection system according to par. (a).

(c) *Exception.* Building additions separated from existing construction by one-hour noncombustible construction need not be provided with a smoke detection system provided the plenum is constructed according to subs. (1) to (8).

History: Cr. Register, March, 1997, No. 495, eff. 4-1-97.

Comm 64.42 Fire dampers and ceiling dampers. **History:** Cr. Register, March, 1997, No. 495, eff. 4-1-97; correction in (2) (d) made under s. 13.93 (2m) (b) 7, Stats., Register, November, 1999, No. 527; r. Register, March, 2000, No. 531, eff. 4-1-00.

Comm 64.43 Dampers and damper controls. (1) **VOLUME DAMPERS AND DEFLECTORS.** Volume dampers, splitters and deflectors shall be provided in all ducts to permit accurate balancing of the system. The dampers, splitters and deflectors shall be adjusted to satisfy the heating and ventilating requirements of the conditioned space and locked in place.

(2) **AIR GRILLES.** All air supply outlets and returns shall be equipped with grilles or devices which will provide a uniform distribution of air.

History: Cr. Register, March, 1997, No. 495, eff. 4-1-97.

Comm 64.44 Fans and blowers. Fans and blowers shall be of a type and size that will satisfy the design conditions of the heating and ventilating system. Fans and blowers shall be rated in accordance with an approved test procedure.

Note: The department accepts certified ratings listed by the Air Moving and Conditioning Association, Inc.

History: Cr. Register, March, 1997, No. 495, eff. 4-1-97.

Subchapter VI — Chimneys, Gas Vents, Mechanical Draft and Venting Devices

Comm 64.45 Chimneys, smoke stacks, gas vents, mechanical draft and venting devices. (1) **GENERAL REQUIREMENTS.** Heating equipment using solid, liquid or gas fuels shall be vented to the outside, except as permitted in s. Comm 64.21. A natural draft chimney or other venting device shall have the height and area to remove the products of combustion. Chimneys, smoke stacks, gas vents, mechanical draft and venting devices shall comply with the requirements of NFPA 211.

(2) **NONCOMBUSTIBLE SUPPORTS.** All chimneys or gas vents shall be supported from noncombustible construction unless otherwise approved.

(3) **TERMINATION.** (a) *Gravity type.* 1. All chimneys or smokestacks depending on a gravity principle for the removal of the products of combustion shall extend at least 3 feet above the highest point of the roof where the chimneys or smokestacks pass through the roof of the building, and at least 2 feet higher than any portion of the building measured 10 feet horizontally from the chimney or smokestack.

2. Type "B", "BW" and "L" vents and single wall vent pipes depending on a gravity principle for the removal of the products of combustion shall extend at least 2 feet above the highest point of the roof where the vents or pipes pass through the roof of the building, and at least 2 feet higher than any portion of the building measured 10 feet horizontally from the vent or pipe.

(b) *Mechanical type.* The height and cross-sectional area may be reduced for chimneys employing a mechanical draft system of either forced or induced draft when approved by the department.

History: Cr. Register, March, 1997, No. 495, eff. 4-1-97; am. (1), Register, February, 1999, No. 518, eff. 3-1-99.

Comm 64.46 Masonry chimneys. The design and construction of the chimney shall conform to the provisions of this section.

(1) **MATERIALS.** The walls shall be built of brick or other approved fire-resistive material. No chimney shall rest upon a flooring of wood nor shall any wood be built into or in contact with any chimney. Combustible headers, beams, joists and studs shall be located at least 2 inches from the outside face of a chimney.

The foundation shall be designed and built in conformity with the requirements for foundations for buildings. In no case shall a chimney be corbeled out more than 6 inches from the wall and in every case the corbeling shall consist of at least 5 courses of brick.

(2) **FLUE SIZE.** Every masonry chimney shall have walls at least 8 inches in solid thickness, except that in a chimney with a flue not larger than 260 square inches where a fire clay or other suitable refractory clay flue lining is used for the full height of the chimney the walls shall not be less than 4 inches in solid thickness. No smoke flue shall have a cross-sectional area less than 64 square inches. Flue linings 7 inches by 7 inches inside, or 8 inches in diameter inside, may be used.

(3) **FLUE LININGS.** All flue linings shall be capable of withstanding reasonably high temperatures and flue gases and shall have a softening point not lower than 1800°F. Flue linings shall be not less than 5/8 inch in thickness and shall be built in as outer walls of the chimney are constructed. Flue linings shall start from a point not less than 8 inches below the bottom of the smoke pipe intake and shall be continuous to a point not less than 4 inches above the enclosing walls.

(4) **SMOKE PIPE CONNECTION.** If there is more than one smoke pipe connected to a flue, the connections shall be at different levels. Two or more heating units, or appliances, may be connected to a common smoke pipe, or breeching, if joined by Y fittings as close as practicable to the flue. In all such cases, the size of the breeching and the flue shall be sufficient to accommodate the total volume of flue gases.

(5) **CLEAN-OUT OPENING.** Every chimney shall be provided with a clean-out opening at the base. Such openings shall be equipped with metal doors and frames arranged to remain closed when not in use.

(6) **WIND PRESSURE.** Every chimney shall be designed to withstand wind pressures in accordance with the requirements of s. Comm 53.12.

History: Cr. Register, March, 1997, No. 495, eff. 4-1-97.

Comm 64.47 Metal smokestacks. (1) **SMOKESTACKS IN EXCESS OF 30 FEET.** (a) The thickness of the metal walls shall be at least 3/16 inch for smokestack heights up to 40 feet and 1/4 inch for greater heights. Stacks used for manufacturing, high-pressure boilers, furnaces or other similar heating or manufacturing appliances shall be lined with firebrick, or equivalent, for a distance of not less than 25 feet from the place where the smoke pipe enters and shall be protected on the outside up to and through the roof of the building with 8 inches of masonry, or a metal shield which provides an 8-inch ventilated air space between such shield and the stack. All stacks shall be properly guyed if the height of the stack exceeds 15 times its least diameter.

(b) Public utility or industrial power plants are exempted from the protection requirements of this paragraph if they are of type 1 or 2 construction.

(2) **SMOKESTACKS LESS THAN 30 FEET.** Smokestacks less than 30 feet high may be constructed of not less than No. 10 U.S. gauge steel, with either welded or riveted joints, and may be mounted directly upon masonry chimneys or foundations or upon industrial heating or power boilers provided all of which are designed to support the stack load. A clearance of not less than 6 inches shall be maintained at all times around such smokestacks and any combustible material within 12 inches of such smokestacks shall be protected by noncombustible insulation covered by sheet metal.

History: Cr. Register, March, 1997, No. 495, eff. 4-1-97.

Comm 64.48 Factory-built chimneys and gas vents. (1) **GENERAL.** Factory-built chimneys and gas vents shall be of an approved type.

(2) **TYPES OF APPROVED CHIMNEYS AND GAS VENTS.** (a) *Residential type and building heating appliance.* An approved "residential type and building heating appliance" chimney or "building heating appliance" chimney may be used with solid-, liquid- or

gas-fired heating appliances where the flue gas temperature does not exceed 1000 F. continuously, and does not exceed 1400°F. for infrequent brief periods of forced firing.

Note: Residential type and building heating appliance chimneys were formerly referred to as Class A chimneys.

(b) *Type "B".* An approved type "B" gas vent may be used with gas-fired appliances where the flue gas temperature does not exceed 550°F. at the outlet of the draft hood.

(c) *Type "BW".* An approved type "BW" gas vent may be used with a vented recessed wall heater.

(d) *Single wall vent pipe.* An approved single wall vent pipe may be used with gas-fired, low-heat appliances (low-pressure boilers, furnaces and space heaters). The vent shall be not less than No. 20 standard gauge galvanized iron, No. 24 Brown and Sharpe gauge sheet copper, or other approved corrosion-resistant material. The installation shall conform to the requirements of s. Comm 64.50.

(e) *Type "L".* An approved type "L" vent may be used with oil-fired appliances listed as suitable by a recognized agency and with gas-fired appliances approved for type "B" vents.

(f) *Equipment listed with venting system.* Venting systems included with the listing of the heating appliance may be used subject to the requirements and limitations of the listing.

Note: The department recognizes, as approved, chimneys designated as "residential type", "building heating appliance", "B", "BW" and "L" types listed by Underwriters' Laboratories, Inc.

History: Cr. Register, March, 1997, No. 495, eff. 4-1-97.

Comm 64.49 Gas vents. All gas ranges (except those designed as unvented), water heaters and other gas-fired equipment shall be provided with vent pipes conforming to the requirements for gas vents as specified in s. Comm 64.48 and for connectors as specified in s. Comm 64.50. Commercial kitchen appliances including but not limited to ranges, ovens, booster heaters and similar equipment may be vented into the kitchen hood exhaust system.

History: Cr. Register, March, 1997, No. 495, eff. 4-1-97.

Comm 64.50 Chimney and vent connectors.

(1) **CONSTRUCTION AND INSTALLATION.** The construction and installation of chimney connectors shall conform with the following requirements:

(a) *Concealed space.* No chimney connector shall pass through any outside window, door or combustible outside wall, nor be concealed in any closet, attic or similar space;

(b) *Combustible partitions and walls.* Connectors for appliances shall not pass through interior walls or partitions constructed of combustible material unless they are guarded at the point of passage by:

1. Metal ventilated thimbles not less than 12 inches larger in diameter than the connector, or

2. Metal or burned fireclay thimbles built in brickwork or other approved fireproofing materials extending not less than 8 inches beyond all sides of the thimble;

(c) *Distance from materials.* Connectors shall be installed with clearance to combustibles specified in par. (b) or NFPA Standard 211;

(d) *Multiple appliance venting.* 1. Two or more appliances using the same type of fuel may be connected to a common gravity-type chimney or vent, provided the appliances are equipped with primary safety controls and listed shutoff devices and comply with the following requirements:

a. The appliances shall be located in the same story, except for engineered venting systems;

b. The appliances shall be joined at a manifold or Y-type fitting as close to the chimney or vent as possible, unless the connector from each appliance enters a separate chimney or vent inlet and the inlets are offset at least 12 inches vertically or are at right angles to each other;

c. The connector and chimney or vent shall be sized to accommodate the total volume of flue gases. For gas-burning appliances, the venting area shall be at least equal to the size of the largest vent connector plus at least 50% of the area of the other vent connectors; or

d. A chimney serving a fireplace or other piece of solid-fuel equipment shall not be used to vent any other appliance.

Note: Engineered venting systems designed in accordance with NFPA 54, "National Fuel Gas Code" are acceptable to the department.

2. Gas utilization appliances and appliances burning liquid fuel may be connected to one chimney flue in accordance with NFPA 211.

(e) *Pitch and length.* Chimney or vent connectors shall have no more than two 45° offsets with the vertical. The horizontal length shall not exceed 75% of the total vertical height of the total venting system measured from the appliance outlet. Chimney or

vent connectors shall be pitched up at least 1/4 inch per foot from the appliance outlet collar to the chimney or vent inlet;

(f) *Dampers.* A manual cast iron or equivalent damper to control the draft shall be provided in the chimney connector next to solid-fuel fired equipment. Manually operated dampers shall be prohibited in chimney or vent connectors of all other appliances. When used, listed automatically operated dampers interlocked with the heating appliance shall be installed in accordance with the approved listing; and

(g) *Materials and thickness.* 1. Except as specified in subd. 2., chimney or vent connectors shall be listed or conform to the type of material and thickness indicated in Table 64.50 or equivalent.

2. Connectors serving listed residential-type gas appliances shall be not less than .016 inch galvanized steel.

TABLE 64.50
MINIMUM CHIMNEY CONNECTOR METAL THICKNESS

Galvanized Steel		
Diameter of Connector	Minimum Thickness(inch)	Gauge
Less than 6 inches	.019	26
6 inches to less than 10 inches	.024	24
10 inches to 13 inches	.030	22
14 inches to 16 inches	.036	20
Greater than 16 inches	.058	16

History: Cr. Register, March, 1997, No. 495, eff. 4-1-97.

Subchapter VII — Equipment Location, Protection, Maintenance and Operation

Comm 64.51 Guarding and fire protection.

(1) **GUARDING OF EQUIPMENT.** Heating and ventilating equipment in gymnasiums, playrooms and similarly occupied areas shall be fully recessed and protected, or located not less than 7 feet above the floor. Heating and ventilating equipment shall not block any part of the required aisles, passageways and corridors.

(2) **GUARDING OF SURFACES.** (a) Equipment located in occupied areas and installed less than 7 feet above the floor shall be guarded to prevent contact with surfaces that are likely to cause lacerations.

(b) Surfaces that are located less than 7 feet above the floor that exceed 180°F in temperature shall be covered with insulating material or be guarded.

(3) **GUARDING OF MECHANICAL APPARATUS.** All mechanical apparatus shall be guarded to comply with the requirements of ch. Comm 32—Safety and Health Standards for Public Employes.

(4) **FIRE PROTECTION.** (a) Heat-producing appliances and their chimney or vent connectors shall be installed with clearances to combustible material as specified in NFPA 211 unless listed for installation at other clearances.

(b) Clearances shall be measured from the outer surface of the appliance or connector to the combustible material, disregarding any intervening protection applied to the combustible material.

(c) Appliances shall not be installed in alcoves or closets unless approved for such installations.

History: Cr. Register, March, 1997, No. 495, eff. 4-1-97; am. (4) (a), Register, March, 2000, No. 531, eff. 4-1-00.

Comm 64.52 Maintenance and operation. (1) **MAINTENANCE.** All heating, ventilating, exhaust and air conditioning systems shall be maintained in good working order and shall be kept clean and sanitary. Clearances and accessibility shall be provided for equipment maintenance. Chimneys or vents and connectors serving solid-fuel burning appliances shall be cleaned and inspected for damage annually. Chimneys and vents, which have

been subjected to a chimney fire, shall not be reused until inspected and approved by the department or authorized deputy.

(2) **OPERATION.** All heating, ventilating and exhaust systems shall be operated to satisfy the requirements of this chapter during periods the building is occupied.

(3) **INSTRUCTIONS.** The designer or installer shall provide the owner with written instructions for the operation and maintenance of the system and equipment.

History: Cr. Register, March, 1997, No. 495, eff. 4-1-97.

Comm 64.53 Final test required. (1) The designer, installer or recognized balancing agency shall be responsible for the testing and balancing of every heating, ventilating and air conditioning system. The person or agency responsible for balancing of the ventilating system shall document in writing the amount of outdoor air being provided and distributed for the building occupants and any other specialty ventilation. The document shall be retained at the site and shall be made available to the department upon request.

(2) (a) Air systems shall be balanced in a manner to minimize losses from damper throttling by first adjusting fan speed then adjusting dampers to meet design flow conditions. Balancing procedures shall be acceptable to the department. Damper throttling alone may be used for air system balancing with fan motors of 1 hp or less, or if throttling results in no greater than 1/3 hp fan horsepower draw above that required if the fan speed were adjusted.

(b) 1. Except as provided in subd. 2., hydronic systems shall be balanced in a manner to minimize valve throttling losses by first trimming the pump impeller or adjusting the pump speed then adjusting the valves to meet design flow conditions.

2. As an exception to subd. 1., valve throttling alone may be used for hydronic system balancing under any of the following conditions:

a. Pumps with pump motors of 10 hp or less;

b. If throttling results in no greater than 3 hp pump horsepower draw for pumps of 60 hp or less, or no greater than 5% of pump horse power draw for pumps greater than 60 hp, above that required if the impeller were trimmed;

c. To reserve additional pump pressure capability in open circuit piping systems subject to fouling. Valve throttling pressure drop shall not exceed that expected for future fouling; or

d. Where it can be shown that throttling will not increase overall building energy costs.

(3) An operating and maintenance manual shall be provided to the building owner or operator. The manual shall include basic data relating to the operation and maintenance of HVAC systems and equipment. Required routine maintenance actions shall be clearly identified. Where applicable, HVAC controls information such as diagrams, schematics, control sequence descriptions, and maintenance and calibration information shall be included.

Note: National Environmental Balancing Bureau (NEBB) Procedural Standards, the Associated Air Balance Council (AABC) National Standards or equivalent balancing procedures are acceptable to the department.

(4) HVAC control systems shall be tested to assure that control elements are calibrated, adjusted, and in proper working condition.

Note: Submittal of the compliance statement is accepted as verification of compliance with this section.

History: Cr. Register, March, 1997, No. 495, eff. 4-1-97.

Subchapter VIII — Occupancy Requirements

Comm 64.54 Factories, office and mercantile buildings. (1) SCOPE. This section applies to all places of employment, mercantile buildings, retail establishments where goods and commodities are bought and sold, and places where not more than 100 persons assemble for worship, recreation, entertainment or dining purposes.

Note: For mall corridors of enclosed mall shopping centers, see s. Comm 64.05, Table 1.

(2) VENTILATION. The air change, supply and distribution for all occupancies in this class shall conform to the requirements of s. Comm 64.05, except that natural ventilation or mechanical ventilation need not be provided in warehouses and cold storage buildings.

(3) INDUSTRIAL EXHAUST SYSTEM. (a) *Contaminants.* Industrial exhaust systems shall be installed and operated to remove harmful contaminants in conformance with ch. Comm 32, Safety and Health Standards for Public Employees.

(b) *Make-up air.* Make-up air shall be provided as required by s. Comm 64.14. The quantity of make-up air shall equal at least 90% of the air exhausted.

Note: The quantity of makeup air shall equal at least 90% of the air exhausted.

(c) *Connections.* Connections between industrial exhaust systems that convey different materials, the combination of which may produce explosive, heat-generating, corrosive, toxic, or otherwise dangerous mixtures, shall be prohibited.

(4) LOCKER ROOMS AND CHANGE ROOMS. Locker rooms and change rooms provided in accordance with s. Comm 54.13 (1) for employees exposed to toxic materials or industrial poisons shall be provided with a direct supply of outside air or air that is transferred from uncontaminated areas. All other locker rooms shall be provided with outside air as specified in Table 64.05.

Note: Exhaust air from locker rooms other than those provided in accordance with s. Comm 54.13 may be directed through the adjoining toilet room or shower room.

History: Cr. Register, March, 1997, No. 495, eff. 4-1-97.

Comm 64.55 Theaters and places of assembly. (1) SCOPE. This section applies to all auditoriums, arenas, armories, assembly halls, banquet halls, billiard rooms, bowling alleys, cafeterias, club rooms, dance halls, dining rooms, gymnasiums, lecture halls, lodge halls, playrooms, restaurants, school auditoriums, Sunday schools and places of worship, funeral home chapels, parochial schools, convents, indoor skating rinks, and theaters which accommodate more than 100 persons for entertainment, recreation, worship, or dining purposes.

Note: For areas that will accommodate less than 100 persons, see s. Comm 64.54.

(2) VENTILATION. The air change, supply and distribution for all occupancies under this classification shall conform to the requirements of s. Comm 64.05.

(3) ALTERNATE SERVICE AND CAPACITY. Heating and ventilating systems installed in places of worship, Sunday schools, and lodge halls may be arranged for selective delivery of the entire service to either the first floor area or to the basement floor area provided these areas are not used simultaneously.

(4) STAGES. The stage in any theater or assembly hall, for which a fire curtain is required, shall be supplied with sufficient air or other means to equalize the pressure to avoid deflecting the curtain.

Note: See ss. Comm 55.21 through 55.23 concerning proscenium walls and curtains.

History: Cr. Register, March, 1997, No. 495, eff. 4-1-97.

Comm 64.56 Schools and other places of instruction. (1) SCOPE. This section applies to all public and private schools, colleges, universities, academies, seminaries, libraries, museums, art galleries, all places used for vocational instruction and research such as laboratories, shops, science rooms, and all parts of buildings used for instructional purposes.

(2) VENTILATION. (a) The air change, supply and distribution shall conform to the requirements of s. Comm 64.05.

(b) For corridors provided with lockers, the air supply shall be accomplished by means of air inlets admitting air from adjacent classrooms or by a direct tempered air supply. Air from corridors with lockers may be recirculated.

(3) EXHAUST SYSTEMS AND HEAT RECOVERY. (a) An exhaust system, as specified in s. Comm 64.54 (3), shall be provided for all equipment and processes that create dust, fumes, vapors and gases injurious to health.

(b) Exhaust systems whose operation is more than 3600 hours per year shall be equipped with heat recovery devices to reduce the energy consumption in the building.

1. 'Exception.' a. Systems exhausting explosive materials, such as perchloric acid need not be so equipped.

b. Fan systems exhausting 250 CFM or less need not be so equipped.

History: Cr. Register, March, 1997, No. 495, eff. 4-1-97.

Comm 64.57 Health care facilities. (1) SCOPE. The rules of this section apply to hospitals, nursing homes and outpatient surgical facilities where medical services are provided.

(2) GENERAL. (a) The heating ventilating and air conditioning systems of all occupancies within the scope of this sections shall be designed, operated and maintained as specified in AIA, "Guidelines for Construction and Equipment of Hospital and Medical Facilities."

Note: Newer versions of the Guidelines may be used in their entirety when approved by the Department.

Note: The 1992-93 edition of the Guidelines has been deemed acceptable and although other portions of the Guidelines may be used for determining the needs of the HVAC system, the majority of the requirements pertaining to the HVAC system will be found in sections 2, 7.31.A. to D., 8.11.A. to D., 9.2.L., 9.4.I., 9.5.L., and 9.6.J of that standard.

Note: The newest version of the Guidelines which has been deemed acceptable is the 1996-97 edition titled "Guidelines for Design and Construction of Hospital and Health Care Facilities" Although other portions of the Guidelines may be used for determining the needs of the HVAC system, the majority of the requirements pertaining to the HVAC system will be found in sections 2, 7.31.A. to D., 8.31.A. to D., 9.31.L., 9.4.I., 9.5.L., and 9.6.J of the newest standard.

(b) The heating, ventilating and air conditioning system shall also be designed, operated and maintained as specified in the applicable sections of the following standards as referenced in AIA, "Guidelines for Construction and Equipment of Hospital and Medical Facilities."

1. NFPA No. 90A;
2. ASHRAE Handbook of Fundamentals; and
3. ASHRAE Standard No. 52.

(3) APPLICATION OF RULES. Where other provisions of ch. Comm 64 specify different requirements than those contained in this section, the requirements in sub.(2) shall govern.

Comm 64.58 Penal institutions and places of detention. (1) SCOPE. This section applies to all corridors and areas of compulsory occupancy in penal institutions, mental hospitals and other places of detention.

(2) VENTILATION. The air change, supply and distribution for all areas of this class shall conform to the requirements of s. Comm 64.05.

(3) OVERNIGHT LOCK-UPS. Where cells are provided for not more than 6 occupants for the purpose of overnight detention only, exhaust ventilation shall be provided on the basis of 6 air changes per hour for the occupied area.

History: Cr. Register, March, 1997, No. 495, eff. 4-1-97.

Comm 64.59 Residential occupancies. (1) SCOPE. This section applies to all apartments, row houses, rooming houses, hotels, motels, dormitories, and all other places of abode.

Note: See s. Comm 51.01 (102a) for definition of "place of abode."

(2) VENTILATION. The air change, supply and distribution for all areas of this class shall conform to the requirements of s. Comm 64.05.

(3) RETURN AIR DUCTS. Unlined wood joists and stud spaces will be permitted to be used as return air ducts in individual living units provided with individual heating and ventilating systems.

History: Cr. Register, March, 1997, No. 495, eff. 4-1-97.

Comm 64.60 Day care facilities. (1) SCOPE. This section applies to all public and private day care centers accommodating more than 4 children, including all buildings or parts of buildings used as child day care facilities.

(2) VENTILATION. The air change, supply and distribution for all areas of this class shall conform to the requirements of s. Comm 64.05.

History: Cr. Register, March, 1997, No. 495, eff. 4-1-97.

Comm 64.61 Repair areas. (1) SCOPE. This section applies to all areas where motor-driven vehicles are repaired involving the fuel system components or requiring the operation of the internal combustion engine.

(2) VENTILATION. The air change, supply and distribution shall be provided in accordance with the requirements of s. Comm 64.05. The exhaust air shall be drawn from not more than 18 inches above the floor.

(3) TAIL PIPE EXHAUST. (a) *Mechanical exhaust system.* A mechanical exhaust system shall be provided in the repair area to remove the exhaust fumes from internal combustion engines. The duct system shall be designed with sufficient outlets to accommodate the total number of vehicles in the repair area. A flexible hose, equipped with a device for connecting it to the exhaust pipe of the vehicle and to the exhaust system, shall be provided. Each outlet shall be provided with a shut-off valve that can be closed when not in use. The blower capacity shall be sufficient to exhaust a volume of air not less than 100 cubic feet per minute for each opening.

(b) *Nonmechanical exhaust.* A noncombustible flexible tube or hose not more than 10 feet long, connected to the engine exhaust (tail pipe) and terminating outside the building, may be used in lieu of the requirements stated in par. (a).

Note: The requirements stated in sub.(2) need not be increased when satisfying the requirements of either sub.(3) (a) or (b). Also see ch. Comm 32, Safety and Health Standards for Public Employees.

(4) MISCELLANEOUS REPAIR AREAS. Areas involved in the servicing of small internal combustion engines such as lawn mowers, snowmobiles, chainsaws, cycles, boat engines, and similar types of engines, and battery charging areas, shall be ventilated as required for repair areas under s. Comm 64.05.

(5) CONTAMINANTS. If the provisions of this section do not provide sufficient ventilation to meet the standards for threshold limit values covered in ch. Comm 32, Safety and Health Standards for Public Employees, the additional exhaust requirements with an equivalent volume of outside air shall be provided to satisfy the requirements found in ch. Comm 32.

History: Cr. Register, March, 1997, No. 495, eff. 4-1-97.

Comm 64.62 Vehicle service buildings. (1) APPLICATION. (a) This section applies to liquid fuel dispensing stations and facilities where vehicles can be driven into the building for washing, greasing, oil change, tire replacement, body repair, and similar operations.

(b) The exhaust air shall be drawn from not more than 18 inches above the floor.

(2) VENTILATION. (a) Air change, supply, distribution and exhaust shall be provided as specified in s. Comm 64.05.

(b) Buildings or portions of buildings having a capacity of and used exclusively for washing 2 or more vehicles simultaneously shall be exhausted at not less than 1/2 cubic foot per minute per square foot of floor area based on that portion of the floor located between the termination of the conveyor system and the vehicle exit door. A supply of makeup air is not required for this exhaust.

(c) If the provisions of this section do not provide sufficient ventilation to meet the standards for threshold limit values covered in ch. Comm 32, Safety and Health Standards for Public Employees, the additional exhaust requirements with an equivalent volume of outside air shall be provided to satisfy the requirements found in ch. Comm 32.

History: Cr. Register, March, 1997, No. 495, eff. 4-1-97.

Comm 64.63 Garages. (1) SCOPE. This section applies to all buildings, or parts of buildings, into which motor vehicles are driven for loading or unloading or are stored.

(2) VENTILATION. (a) Except as permitted in pars. (b), (c) and (d), the air change, supply and distribution for garages shall be provided in accordance with s. Comm 64.05. Exhaust air shall be drawn not more than 18 inches above the floor.

(b) The air change, supply and distribution for a storage garage accommodating 6 or more vehicles may be provided by permanent open-wall areas, if:

1. The open-wall areas equal at least 30% of the total wall area enclosing the garage;
2. The open-wall areas are distributed to permit air circulation throughout the garage; and
3. The entire floor of the garage is located at or above grade.

(c) The air movement, supply and distribution for a storage garage accommodating 6 or more vehicles may be provided by 3% openings that comply with s. Comm 64.05 (4) if:

1. The building is unoccupied.
2. The storage garage building does not contain and is not attached to any other occupancy or use.
3. The entire floor of the garage is located at or above grade.

(d) An intermittent mechanical exhaust ventilation system may be used in lieu of continuous exhaust if the conditions given in subs. 1. and 2. are met.

1. The system shall be activated to provide exhaust ventilation rates specified in s. Comm 64.05 by a continuous monitoring and detection system which can maintain carbon monoxide levels below 35 ppm and nitrogen dioxide levels below one ppm.

2. The system shall be provided with automatic controls to provide exhaust ventilation at a rate of 1/2 cfm per square foot for a total of at least five hours in each 24-hour period.

3. A means shall be provided to maintain negative pressure relative to adjacent areas.

(3) CONTAMINANTS. If the provisions of this section do not provide sufficient ventilation to meet the standards for threshold limit values covered in ch. Comm 32, Safety and Health Standard

for Public Employes, the additional exhaust requirements with an equivalent volume of outside air shall be provided to satisfy the requirements found in ch. Comm 32.

Comm 64.64 Vehicle showrooms. (1) SCOPE. This section applies to all vehicle showrooms with offices and occupancies unless designed as part of the vehicle garage adjacent to repair or vehicle storage areas where all vehicles displayed in the showroom are without batteries and fuel tanks are empty and free of fumes.

Note: A live storage area is any area used for storage of fire trucks, tractors, automobiles, trucks, and similar self-propelled vehicles which are driven in and out of the storage area under their own power; it does not include areas where vehicles and equipment are stored for seasonal periods, or areas where vehicles are displayed without batteries and where the gasoline tanks of the vehicles are empty and free of fumes.

(2) VENTILATION. The air change, supply and distribution shall be provided in accordance with the requirements of s. Comm 64.05.

(a) Separate ventilating system. A separate ventilating system shall be provided for showrooms or offices where such occupancies are adjacent to repair or live storage areas.

Note: Ventilation is not required if an openable area is provided to conform with the requirements of s. Comm 64.07.

(b) Recirculation. Air shall not be recirculated from any repair, live storage or service area unless the total volume of air in circulation is in excess of the ventilation required. Excess air may be recirculated.

(c) Contaminants. If the provisions of this section do not provide sufficient ventilation to meet the standards for threshold limit values covered in ch. Comm 32, Safety and Health Standards for Public Employes, the additional exhaust requirements with an equivalent volume of outside air shall be provided to satisfy the requirements found in ch. Comm 32.

History: Cr. Register, March, 1997, No. 495, eff. 4-1-97.

Comm 64.65 General sanitation and service areas.

(1) SCOPE. This section applies to toilet rooms, diaper changing rooms, locker rooms, shower rooms, and janitor closets. Separate diaper changing rooms shall be ventilated in the same manner as required for toilet rooms at 2 cfm per square foot.

(2) EXHAUST VENTILATING SYSTEMS. Exhaust ventilating systems serving this class of occupancy may be combined with other exhaust services provided the combined system:

(a) Does not allow recirculation; and

(b) Does not include grease hood exhaust, radioactive exhaust, fume hood exhaust, exhaust required by ch. Comm 32, exhaust that requires electrical grounding, or exhaust that requires spark resistant fan construction.

(3) VENTILATING SYSTEM APPLICATION. Ventilation shall be provided for all areas of this class in accordance with this subsection. Areas of this class that are not ventilated in accordance with applicable pars. (a) through (e) shall be provided with mechanical exhaust ventilation as specified in s. Comm 64.05. The effectiveness of the exhaust shall be greater than the supply.

(a) Toilet rooms that have only one water closet or urinal shall be provided with either natural ventilation via a window with at least 2 square feet of area openable directly to the outside, or mechanical exhaust ventilation as specified in s. Comm 64.05. Toilet rooms that have only one water closet or urinal that are not located in restaurants or taverns may use an approved ductless air circulating and treatment device in place of natural or exhaust ventilation.

(b) Janitor closets that have only one service sink or receptor shall be provided with either natural ventilation via a window with at least 2 square feet of area openable directly to the outside, or an approved ductless air circulating and treatment device, or mechanical exhaust ventilation as specified in s. Comm 64.05.

(c) Bathrooms with one bathtub or shower, or one combined tub and shower, and one water closet or urinal shall be provided

with mechanical exhaust ventilation capable of exhausting 50 cubic feet per minute.

(d) Adjoining locker, shower and toilet rooms shall be exhausted at the rate specified in s. Comm 64.05, based on the largest amount of exhaust required for any of the three rooms. The rooms shall be provided with tempered make-up air supplied directly from the outside or transferred from other areas of the building in accordance with s. Comm 64.18. A negative pressure relationship shall be maintained in the shower and toilet rooms with respect to the locker room.

(e) Rooms for the changing of clothing only with provisions for short-term storage of clothes, other than areas for industrial employes as specified in s. Comm 64.54 or areas for employes exposed to toxic materials as specified in s. Comm 54.13, shall be ventilated as changing rooms as specified in s. Comm 64.05, Table 64.05. This paragraph does not apply to shower or toilet rooms.

(f) Chemical or septic toilets shall not be placed in rooms provided with mechanical ventilation. Toilet rooms with chemical or septic toilets shall be provided with natural ventilation via a window with at least 2 square feet of area openable directly to the outside. The window shall be provided with a screen to limit the passage of insects and vermin.

(4) MAINTENANCE OF NEGATIVE PRESSURE. Toilet rooms and janitor closets shall be provided with negative pressure relative to adjacent areas. If supply air is provided to toilet rooms or janitor closets, the exhaust must also be provided simultaneously.

History: Cr. Register, March, 1997, No. 495, eff. 4-1-97.

Comm 64.66 Natatoriums. (1) POOL VENTILATION. In natatoriums, a volume of tempered outside air supply and exhaust shall be provided at the rate specified in s. Comm 64.05. The tempered outside air may be supplied directly from the outside or transferred from other areas of the building in accordance with s. Comm 64.18. The volume of tempered air and exhaust may be reduced to a minimum of one cubic foot per minute per square foot of pool surface provided automatic humidity controls are used to limit the relative humidity to 60%.

(2) AIR MOVEMENT. The air change rate in a natatorium shall be not less than 6 air changes per hour unless mechanical cooling is provided to satisfy the heat gain requirement for the space.

History: Cr. Register, March, 1997, No. 495, eff. 4-1-97.

Comm 64.67 Kitchens. (1) SCOPE. This section applies to all areas where food is prepared, except in domestic science educational facilities from grades kindergarten through 12, and within individual dwelling units of buildings under the scope of chs. Comm 57 and Comm 66.

(2) EXHAUST VENTILATION SYSTEMS. Exhaust ventilation systems serving this occupancy shall not be used for any other service.

(a) Required exhaust ventilation. When cooking equipment is being operated, mechanical exhaust ventilation shall be provided at a rate specified in s. Comm 64.05 for every occupied area within the scope of this section. When cooking equipment is not being operated, a minimum supply of outside air and exhaust at 7.5 cfm per person or natural ventilation with openings equal in area to 3% of the floor area as specified in s. Comm 64.07 shall be provided during periods of occupancy.

(b) Kitchen exhaust hoods. Cooking equipment which produces grease laden vapors, including but not limited to fryers, grills, griddles and broilers, shall be provided with a kitchen exhaust hood, except an exhaust hood does not have to be provided for a single piece of equipment if:

1. The piece of equipment has a frying/cooking surface area of 4 square feet or less; and

2. The piece of equipment is the only piece of grease-producing equipment for the entire food preparation operation.

(3) **REPLACEMENT AIR.** Adequate replacement air shall be provided to equal the air being exhausted by all exhaust systems.

(4) **EXHAUST HOOD REQUIREMENTS.** (a) *Size of hood.* The horizontal inside dimensions for canopy hoods shall be sized to effectively capture grease vapors, but in no case shall these dimensions be less than the overall horizontal dimensions of the grease-producing equipment. The horizontal inside dimensions for noncanopy, prefabricated backshelf hoods may be less than the overall horizontal dimensions of the grease-producing equipment.

(b) *Exhaust rates.* The kitchen exhaust hood shall be provided with a capture velocity to effectively capture the grease vapors and may be designed through engineering analysis or the empirical design formulas stated below:

1. 'Canopy hood.' Hood open on all 4 sides: $Q = 125 \text{ cfm A (area)}$.

2. 'Wall hood.' Hood open on 3 sides or less: $Q = 80 \text{ cfm A (area)}$.

3. 'Slotted-type hood.' $V = 350$ feet per minute through the slot opening. The slot shall be at least 3 inches in width and shall extend around the open sides of the hood; and

4. 'Noncanopy hood.' The minimum volume of exhaust air for noncanopy type hoods (prefabricated backshelf) may be not less than $Q = 200 \text{ cfm L (length)}$.

Note: Q equals the exhaust air in cubic feet per minute; A equals the area of the hood over the grease-producing equipment in square feet; V equals the velocity in feet per minute; and L equals the total length in feet of the cooking appliance being ventilated, and measured parallel to the front edge of the appliance.

(c) *Materials.* Hoods shall be constructed and supported by steel not less than .0478 inch U.S. standard gage (No. 18 manufacturers standard gage) or stainless steel not less than .0359 inch U.S. standard gage (No. 20 manufacturers standard gage) or other materials of equivalent strength, fire and corrosion resistance.

Note: The Department of Health and Social Services (DHSS) may have additional requirements for materials in commercial food preparation areas. For more information, contact the DHSS Environmental Sanitation Unit.

(d) *Seams.* All seams and joints shall be liquid-tight.

(e) *Grease-removal devices.* Approved grease extractors, grease filters or other grease-removal devices shall be provided.

(f) *Exposed hood surfaces.* Hood surfaces and exposed exhaust ducts within 18 inches of combustible material shall be protected as specified in sub. (5) (f).

(g) *Concealed hood surfaces.* Hood surfaces that are concealed by or recessed into adjoining construction shall be protected as specified in sub. (5) (f).

(h) *Double-wall hoods utilizing outdoor air.* When hoods are connected to ducts supplying outside air, performance data shall be submitted.

Note: Double-wall hoods provided with a supply of outdoor air conserve energy.

(5) **EXHAUST DUCTS FROM HOODS.** (a) *Design.* All ducts shall lead, as directly as possible, to the exterior of the building without forming dips or traps which collect residues. Ducts exposed to the exterior shall be protected with a suitable weatherproof coating.

Note: Note: Temperatures in excess of 2000°F. may be experienced within ducts in the event of fire. A means of expansion of long ducts should be considered.

(b) *Materials.* Ducts shall be constructed of and supported by steel not lighter than .0598 inch U.S. standard gage (No. 16 manufacturers standard gage) or stainless steel not lighter than .0478 inch U.S. standard gage (No. 18 manufacturers standard gage) or other materials of equivalent strength, fire and corrosion resistance.

(c) *Seams and joints.* All seams and joints shall be liquid-tight.

(d) *Clean-out openings.* Accessible clean-out openings at the sides of ducts shall be provided at each change of direction of the duct for inspection and servicing.

(e) *Interior ducts.* Ducts shall not pass through required fire walls or partitions.

(f) *Duct enclosure.* 1. A grease duct that penetrates or passes through any ceiling, wall or floor shall be completely enclosed from the point of penetration to the outlet terminal.

2. The duct enclosure shall meet one of the following requirements:

a. The duct shall be enclosed in a noncombustible 2-hour rated fire-resistive enclosure.

b. The duct shall be completely covered on all sides with a material classified and labeled for such purpose and the penetration shall be protected with a classified through-penetration fire-stop system with F and T ratings at least equal to the rating of the assembly being penetrated.

(g) *Exposed exhaust ducts.* Exposed exhaust ducts connected to hoods or canopies shall be located not less than 18 inches from combustible material unless the duct is protected in accordance with the requirements of par. (f).

(h) *Air discharge.* The air discharge shall be directed away from the roof or combustible materials.

(i) *Dampers.* 1. Fire dampers shall not be installed in kitchen exhaust duct systems unless the assembly includes an approved extinguishing system designed to operate with a fire damper in the closed position.

2. Dampers shall be accessible for cleaning and maintenance.

(6) **AUTOMATIC SUPPRESSION SYSTEMS.** (a) *General.* 1. Exhaust hood and duct systems in commercial kitchen applications shall be protected with an automatic fire suppression system.

2. The type of automatic fire suppression system used shall be recognized by a national standard as being appropriate for use in commercial kitchen applications.

3. Manufactured fire suppression systems shall be listed and labeled for use in commercial kitchen applications or shall comply with one of the applicable standards listed in s. Comm 51.235.

4. Alternate suppression systems shall comply with the applicable standard listed in s. Comm 51.235.

5. Automatic fire sprinkler systems shall comply with s. Comm 51.23.

(b) *System interconnection.* When the fire suppression system is activated, all gas and electrical sources serving cooking appliances, grease consuming appliances or fume incinerators and equipment associated with the hoods shall be automatically deactivated. Such gas and electrical sources shall not be capable of reactivation except by manual means after the fire suppression system has been serviced and is again ready for action;

(c) *Actuation.* 1. Except as provided in subd. 2., hood and duct suppression systems shall provide for both automatic and manual actuation of the system;

2. Automatic fire sprinkler systems using water need not be provided with means for manual actuation.

(d) *Manual actuator location.* A manual station for actuation of the suppression system shall be located at or near one of the means of egress from the area but not nearer than 10 feet to the range hood and shall be securely mounted not less than 4 1/2 feet nor more than 5 feet above the floor, unless otherwise specifically approved by the chief of the fire department having jurisdiction;

(e) *Maintenance.* The automatic fire suppression system shall be maintained at full operating capacity by the owner in accordance with its listing, the manufacturer's instructions and the maintenance requirements of ss. Comm 51.23 or 51.235.

(f) *Service accessibility.* All nozzles shall be accessible for cleaning and replacement.

(g) *Carbon dioxide systems.* Carbon dioxide systems protecting commercial cooking equipment shall be installed in accordance with NFPA 12 and the following provisions:

1. A nozzle shall be provided at the top of the duct.

2. Where ducts exceed 20 feet of vertical distance or 50 feet of horizontal distance, additional nozzles shall be installed within the duct in a symmetrical pattern to give uniform distribution of carbon dioxide.

3. a. Dampers shall be installed at either the top or the bottom of the duct and shall operate automatically upon activation of the carbon dioxide system.

b. Where the damper is located at the top of the duct, the top nozzle shall be immediately below the damper.

4. The carbon dioxide system shall be sized to protect all hazards venting through a common duct simultaneously.

(h) *Automatic fire sprinkler systems.* Automatic fire sprinkler systems protecting commercial cooking equipment shall be installed in accordance with NFPA 13 and the following provisions:

1. Automatic sprinkler systems protecting commercial cooking equipment shall be provided with a separate, readily-accessible indicating-type control valve that is clearly identified.

2. Sprinklers used to protect fryers shall be listed for such use and shall be installed in accordance with the listing.

(7) **SUPPLY DUCTS TO HOODS.** Kitchen hood supply ducts shall meet SMACNA gauge steel thicknesses. Exhaust hood assem-

blies with integrated air supply plenums shall be designed and provided with a fire-actuated damper as specified in NFPA 96.

(8) **MAINTENANCE OF DUCT AND HOOD SYSTEMS.** Duct and hood systems shall be maintained in accordance with NFPA 96.

(9) **PORTABLE FIRE EXTINGUISHERS.** (a) Portable fire extinguishers shall be provided in accordance with s. Comm 51.22.

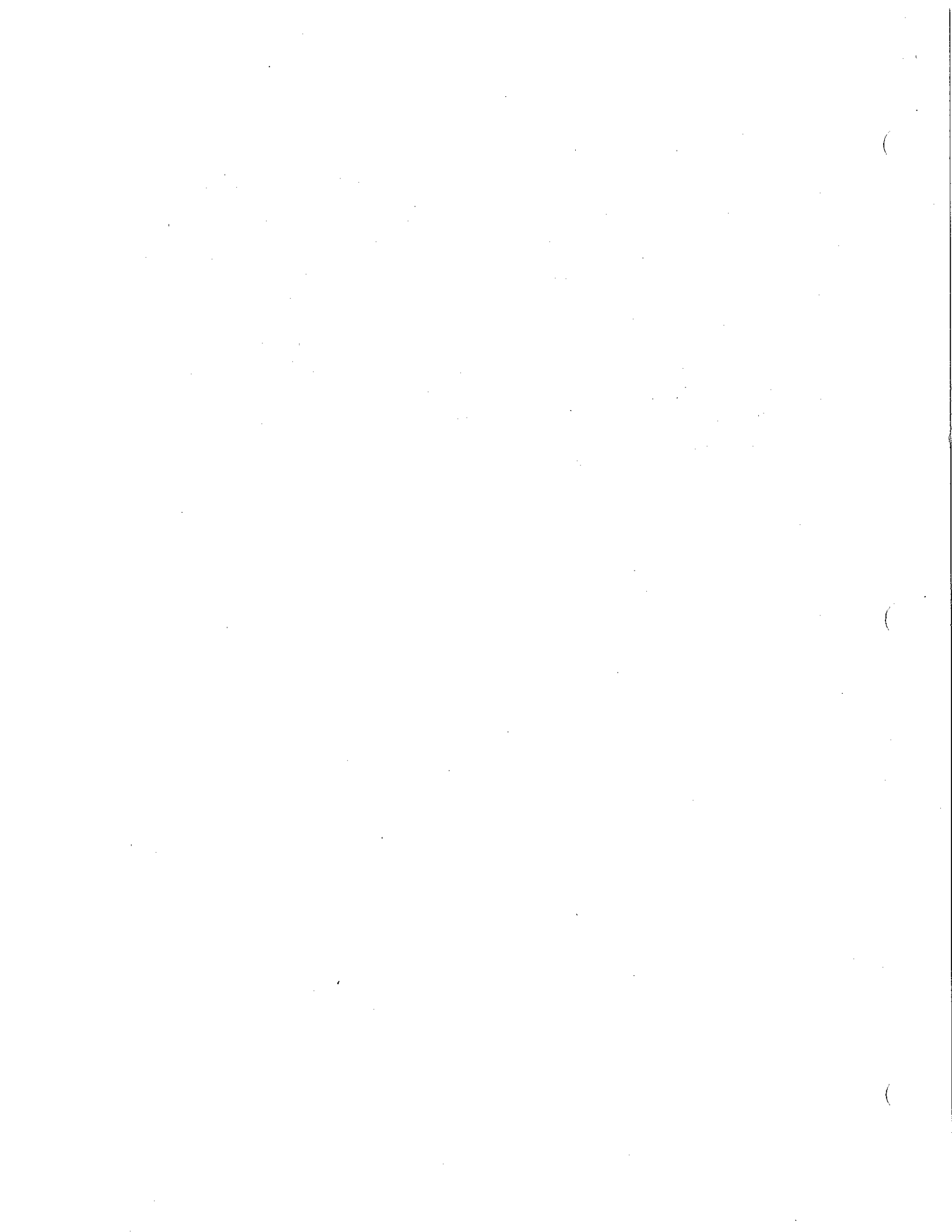
(b) The extinguishing agent in the portable fire extinguisher shall be compatible with the extinguishing agent in the automatic suppression system as determined by the manufacturers.

History: Cr. Register, March, 1997, No. 495, eff. 4-1-97; am. (1), r. and recr. (5) (f), r. (6) (intro.), renum. (6) (a) to (e) to be (6) (b) to (f), cr. (6) (a), (g), (h), (8) and (9) and am. (6) (e) as renum., Register, March, 2000, No. 531, eff. 4-1-00.

Comm 64.68 Seasonal occupancies. When approved in writing by the department, heating requirements may be waived but not ventilation required by s. Comm 64.05, Table 1 during the period of May 15 through September 15 for the following or similar occupancies: drive-in eating places, club houses, outdoor toilets, camp lodge buildings, canning factories and migrant labor camps.

Note: Rules on migrant labor can be found in ch. DWD 301.

History: Cr. Register, March, 1997, No. 495, eff. 4-1-97.



Chapters Comm 50—64

APPENDIX A

The material contained in the appendix is for clarification purposes only. The notes, illustrations, etc. are numbered to correspond to the number of the rule as it appears in the text of the code.

Comm A-50.06 (3) ISSUANCE OF BUILDING PERMITS. Section Comm 50.06 (3) refers to s. Comm 83.25 (2), which reads as follows:

Comm 83.25 (2) ISSUANCE OF BUILDING PERMITS. (a) *General.* Pursuant to s. 66.036, Stats., the issuance of building permits by a municipality for unsewered properties shall be in accordance with this subsection.

(b) *New construction.* A municipality may not issue a building permit to commence construction or installation of a structure that necessitates the use of a POWTS to serve the structure, unless:

1. The owner of the property possesses a sanitary permit for the installation of a POWTS in accordance with s. Comm 83.21; or

Note: Section Comm 83.21 outlines the procedures for the issuance of sanitary permits. Sections 145.135 and 145.19, Stats., mandate that no private sewage system may be installed unless the owner of the property holds a valid sanitary permit.

2. A POWTS of adequate capability and capacity to accommodate the wastewater flow and contaminant load already exists to serve the structure.

Note: See ss. Comm 83.02 and 83.03 concerning the application of current code requirements to existing POWTS.

(c) *Construction affecting wastewater flow or contaminant load.*

1. A municipality may not issue a building permit to commence construction of any addition or alteration to an existing structure when the proposed construction will modify the design wastewater flow or contaminant load, or both, to an existing POWTS, unless the owner of the property:

- a. Possesses a sanitary permit to either modify the existing POWTS or construct a POWTS to accommodate the modification in wastewater flow or contaminant load, or both; or

- b. Provides documentation to verify that the existing POWTS is sufficient to accommodate the modification in wastewater flow or contaminant load, or both.

2. For the purpose of this paragraph, a modification in wastewater flow or contaminant load shall be considered to occur:

- a. For commercial facilities, public buildings, and places of employment, when there is a proposed change in occupancy of the structure; or the proposed modification affects either the type or number of plumbing appliances, fixtures or devices discharging to the system; and

- b. For dwellings, when there is an increase or decrease in the number of bedrooms.

(d) *Documentation of existing capabilities.* Documentation to verify whether an existing POWTS can accommodate a modification in wastewater flow or contaminant load, or both, shall include at least one of the following:

1. A copy of the plan for the existing POWTS that delineates minimum and maximum performance capabilities and which has been previously approved by the department or the governmental unit.

2. Information on the performance capabilities for the existing POWTS that has been recognized through a product approval under ch. Comm 84.

3. A written investigative report prepared by an architect, engineer, designer of plumbing systems, designer of private sewage systems, master plumber, master plumber-restricted service or certified POWTS inspector analyzing the proposed modification and the performance capabilities of the existing POWTS.

(e) *Setbacks.* 1. A municipality may not issue a building permit for construction of any structure or addition to a structure on a site where there exists a POWTS, unless the proposed construction conforms to the applicable setback limitations under s. Comm 83.43 (8) (i).

2. The applicant for a building permit shall provide documentation to the municipality issuing the building permit showing the location and setback distances for the proposed construction relative to all of the following:

- a. Existing POWTS treatment components.

- b. Existing POWTS holding components.

- c. Existing POWTS dispersal components.

Note: A municipality which issues building permits may delegate to the governmental unit responsible for issuing sanitary permits the determination of whether the proposed construction will affect or interfere with an existing POWTS relating to capability or location of the existing POWTS.

A-51.01 (12) BUILDING. The intent was to consider permanent awnings as part of a building.

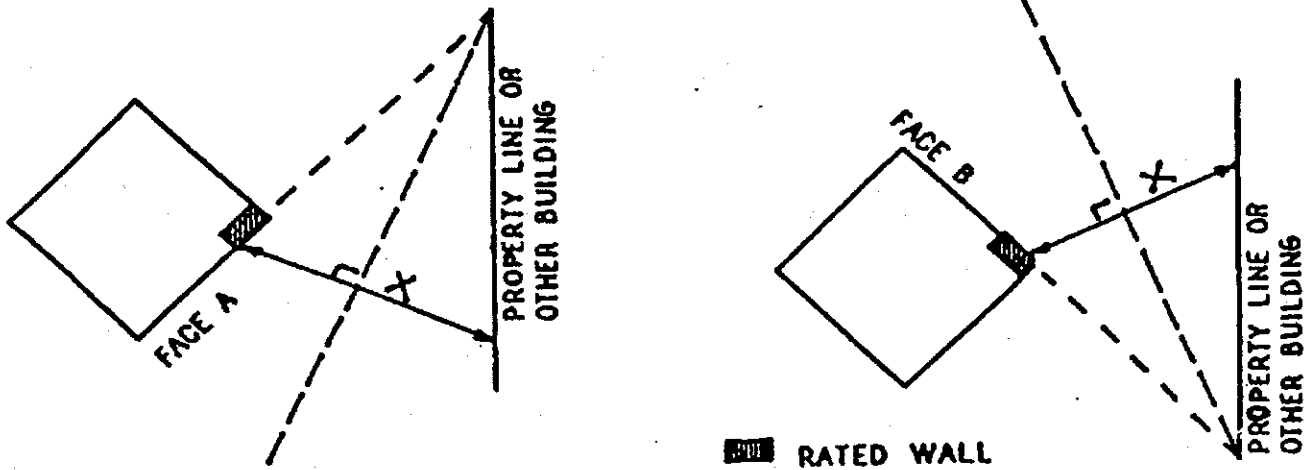
A-51.01 (42) FAMILY. The intent of this definition is to clarify the use of the word "family" in reference to s. Comm 51.01 (102a); it is not intended as a variance to the definition stated under s. Comm 51.01 (102a) (b).

A-51.01 (67a) HABITABLE ROOM. It is the intent that rooms designated as recreation, study, den, family room, office, etc. and providing the only space for living and/or sleeping are considered

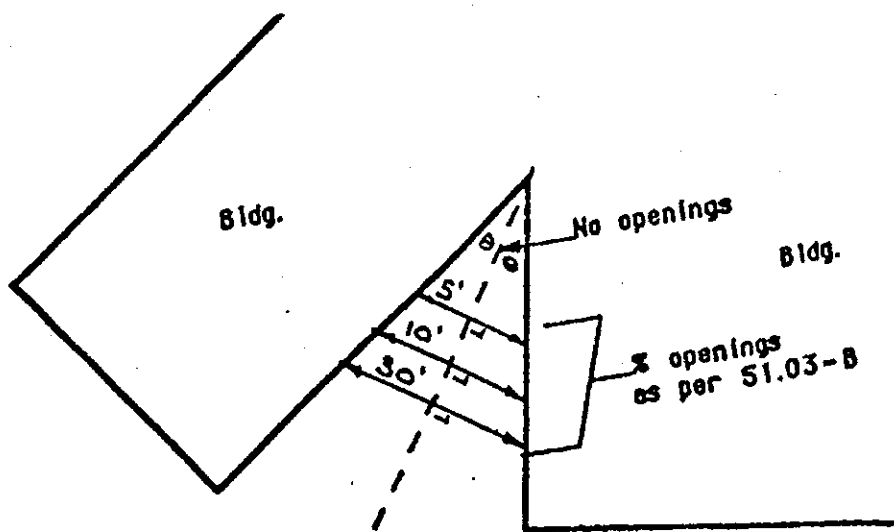
habitable rooms.

A-51.01 (115) SETBACK. The intent was to not include gutters, downspouts, outdoor lighting fixtures, signs and similar attachments as part of a building.

To determine the portion of a wall (A) that is within a distance X from a property line or another building, extend the wall face to its intersection with the property line or other building. Bisect the angle formed by the intersection. Measure X perpendicular to the bisector. Repeat these steps for wall face B.



The following sketch shows setback measurements between intersecting or projected intersection of building faces.



A-51.01 (121) STORIES, NUMBER OF. For further clarification, refer to A-51.02 (14).

A-51.01 (144) WALL (DIVISION).

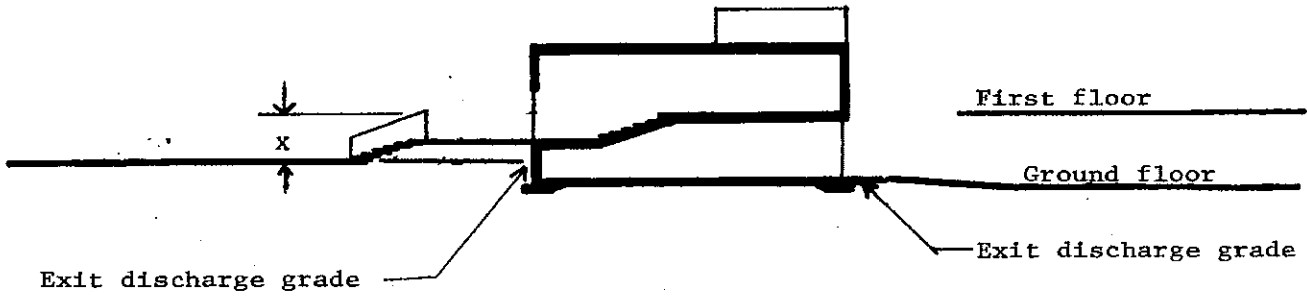
(a) *Building division wall* is intended to denote a wall constructed in a manner sufficient to meet requirements for a party wall [see "Wall (Party)"] and is acceptable as a dividing wall or enclosing wall when determining the volume of a building as referred to in ss. Comm 50.07, 50.10 and 50.12.

(b) *Fire division wall* is intended to relate to construction that provides separation between portions of a building to satisfy allow-

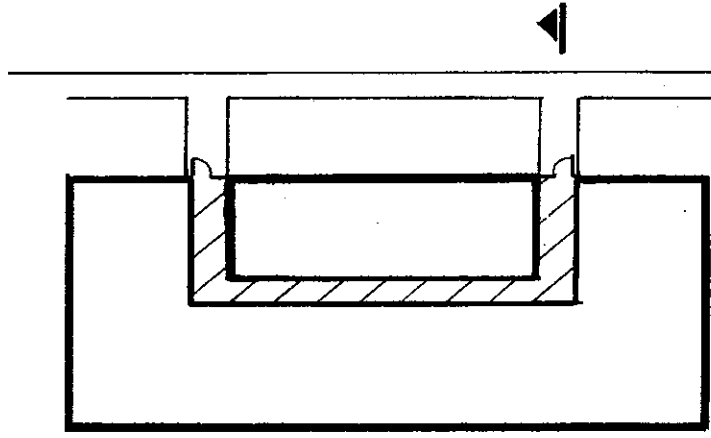
able floor area limitations, separation between 2 classes of construction, or separation of hazardous occupancies. For other separations, see "occupancy separations" and isolation of hazards sections of this code.

A-51.01 (151) WALL (PARTY). It is intended that a property consisting of joining plotted subdivisions owned by one individual, that can be owned by separate individuals, is included in the definition of party wall.

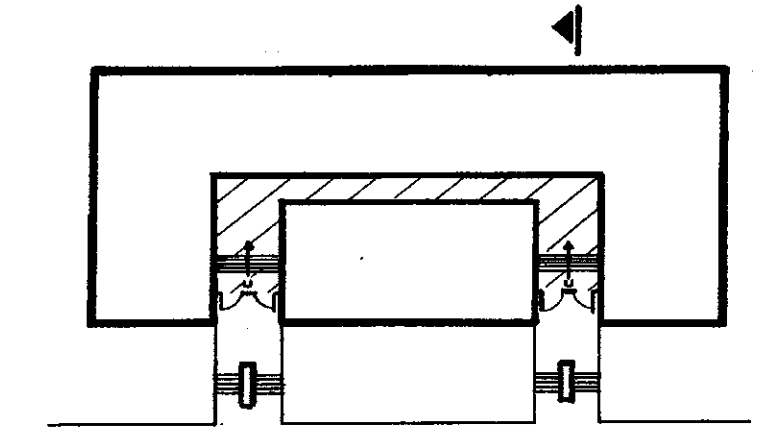
A-51.02 (14) DETERMINATION OF NUMBER OF STORIES. The following illustrations are provided to give visual aid to this rule and the definition of s. Comm 51.01 (121) Stories, Number of.



Note: X = 6'-0" (maximum)



Ground floor



First floor

A-51.03 (5) (a) EXTERIOR MASONRY CONSTRUCTION. The following Figures 1, 2, 3, 4, 5A and 5B illustrate typical details for various wall construction alternatives, which satisfy the intent of this rule for Type 5—Exterior Masonry Construction.

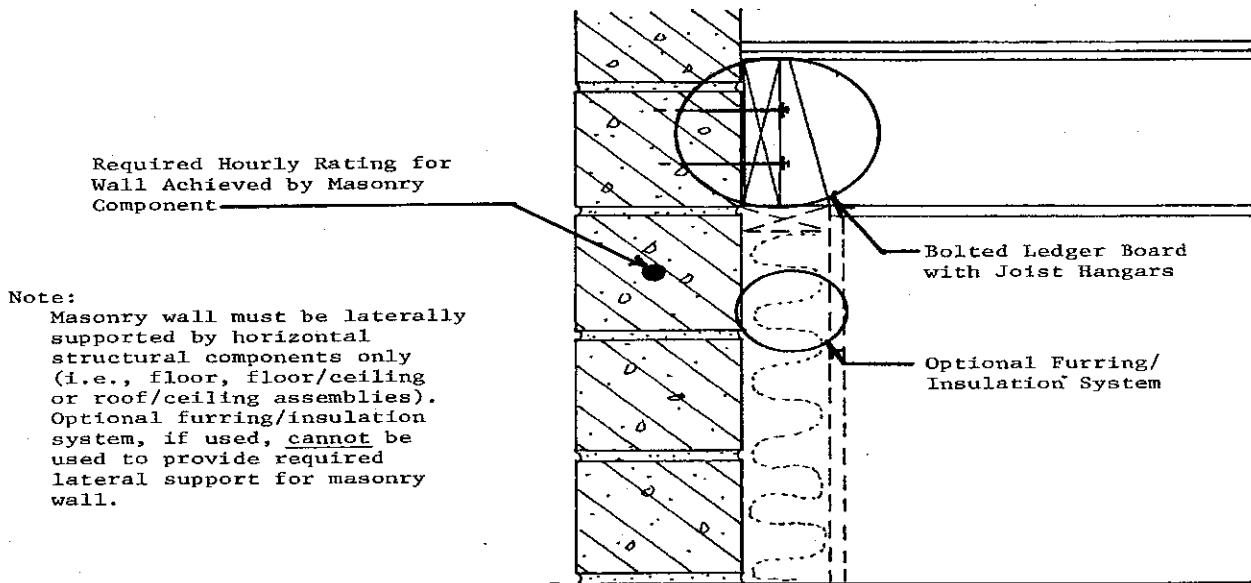


FIGURE 1
Single Wythe Masonry Wall
(Bearing Condition)

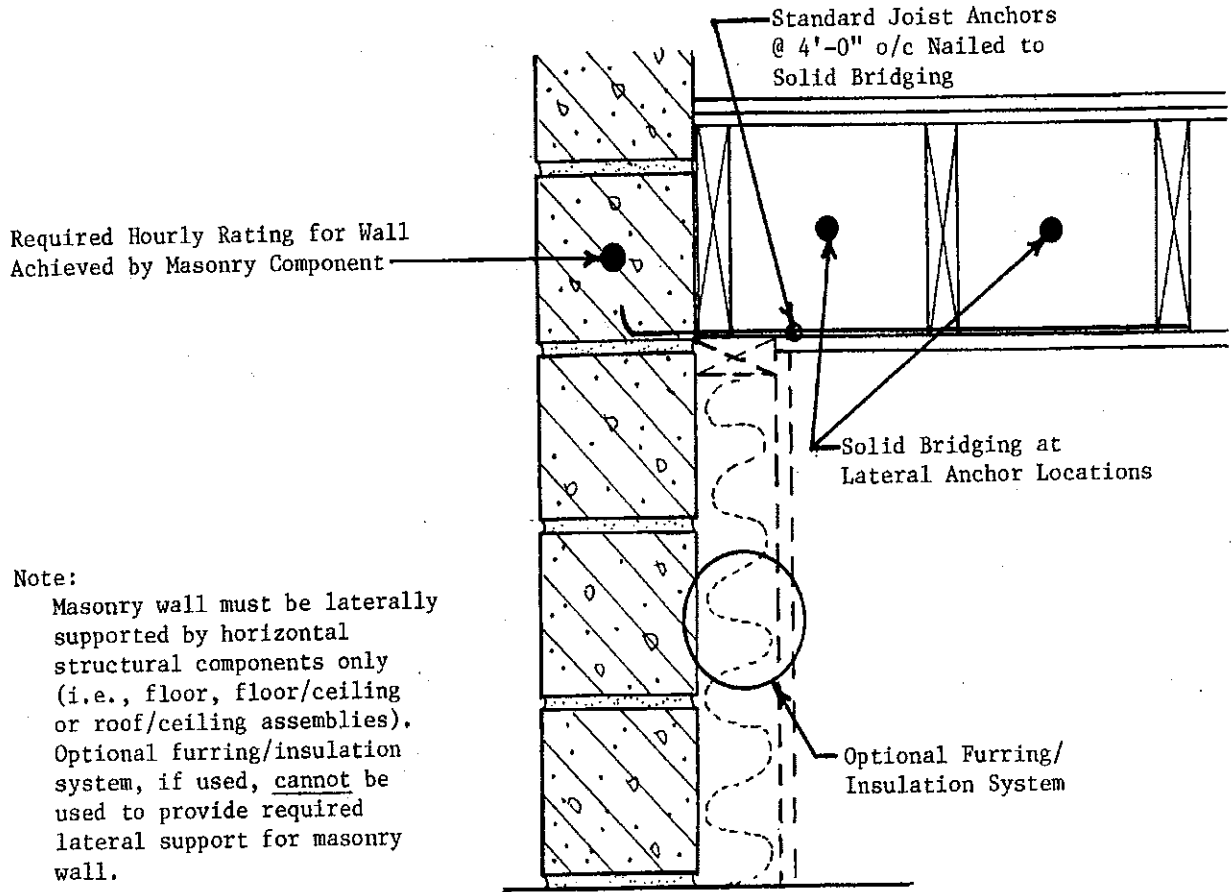


FIGURE 2
Single Wythe Masonry Wall
(Non-Bearing Condition)

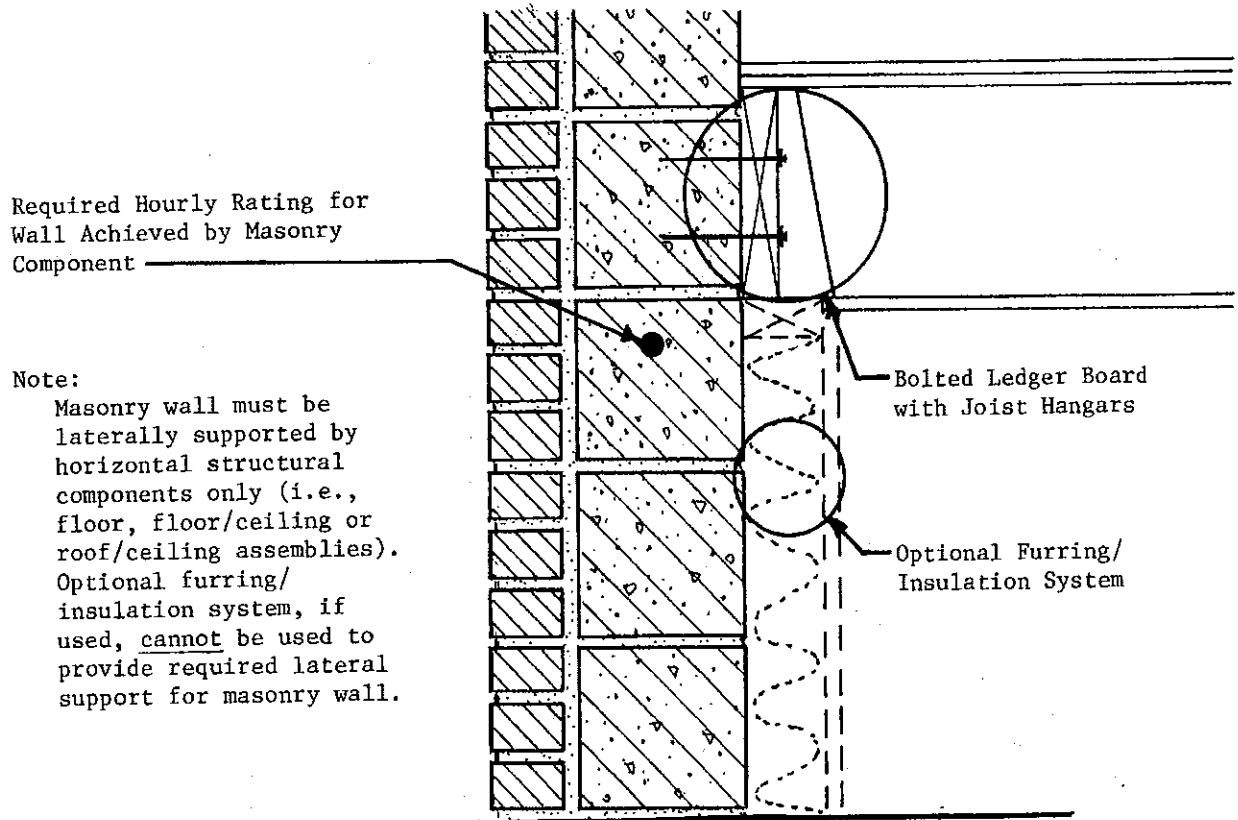


FIGURE 3
Multi-Wythe Masonry Wall
(Bearing Condition)

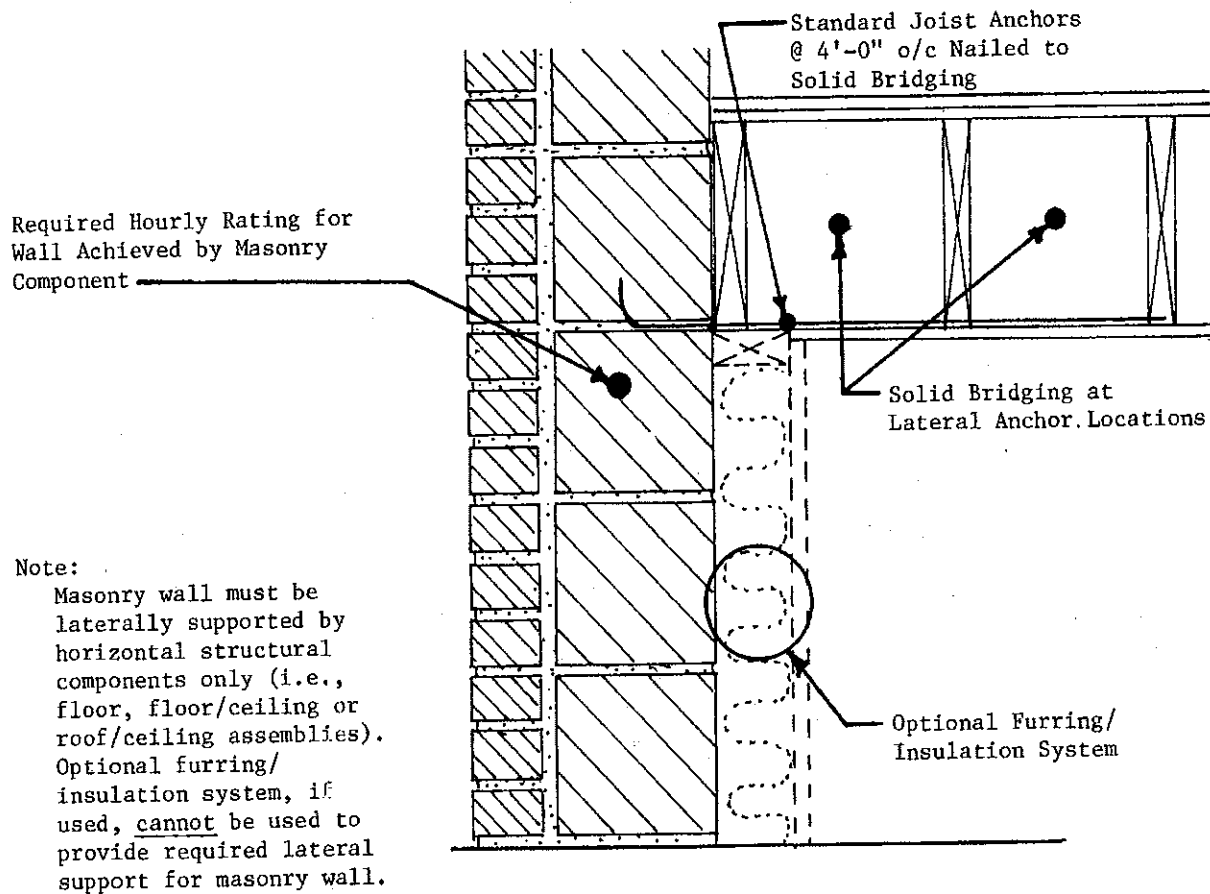


FIGURE 4
Multi-Wythe Masonry Wall
(Non-Bearing Condition)

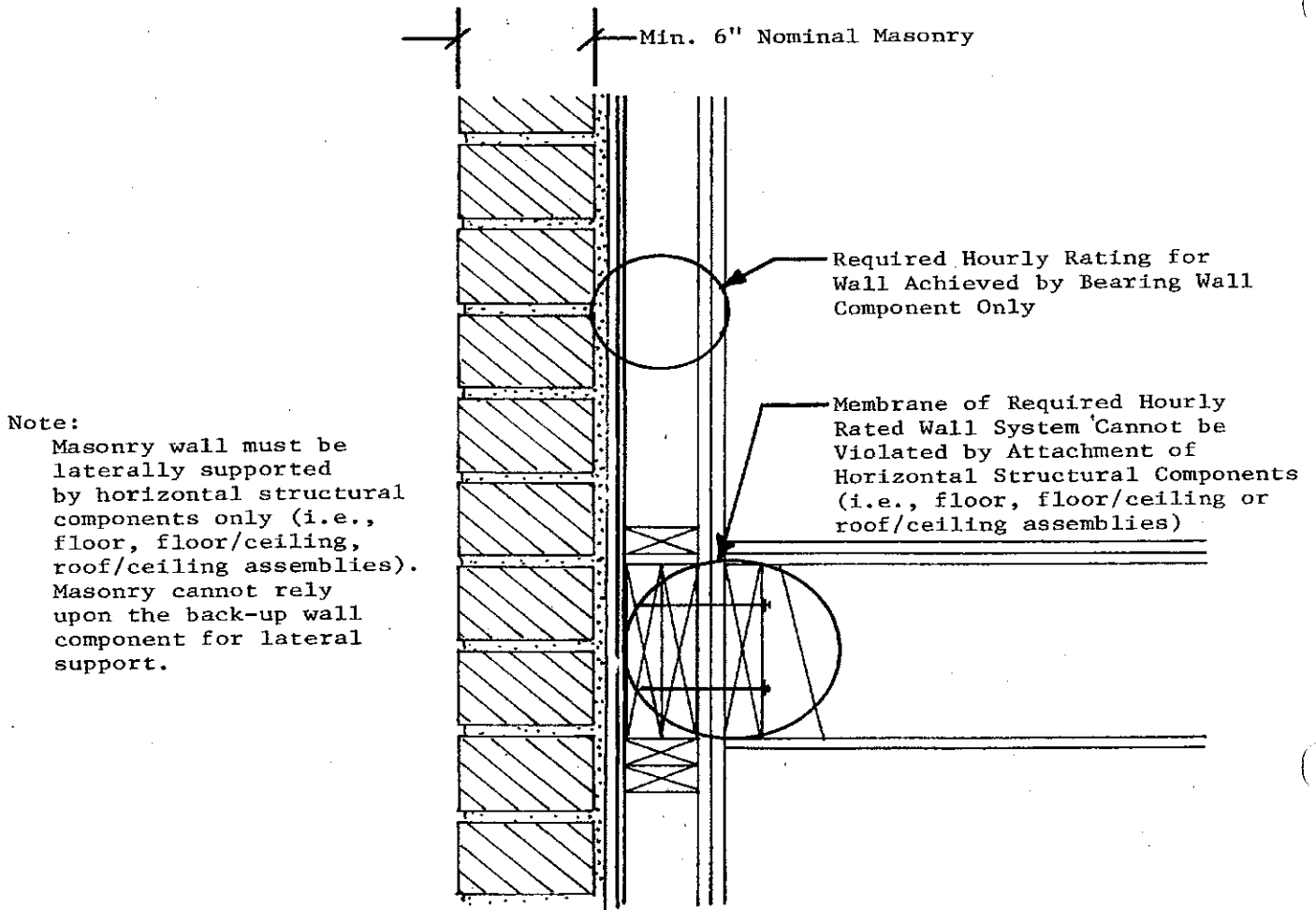


FIGURE 5A
Combination Masonry/Frame Wall
(Bearing and Non-Bearing Condition)

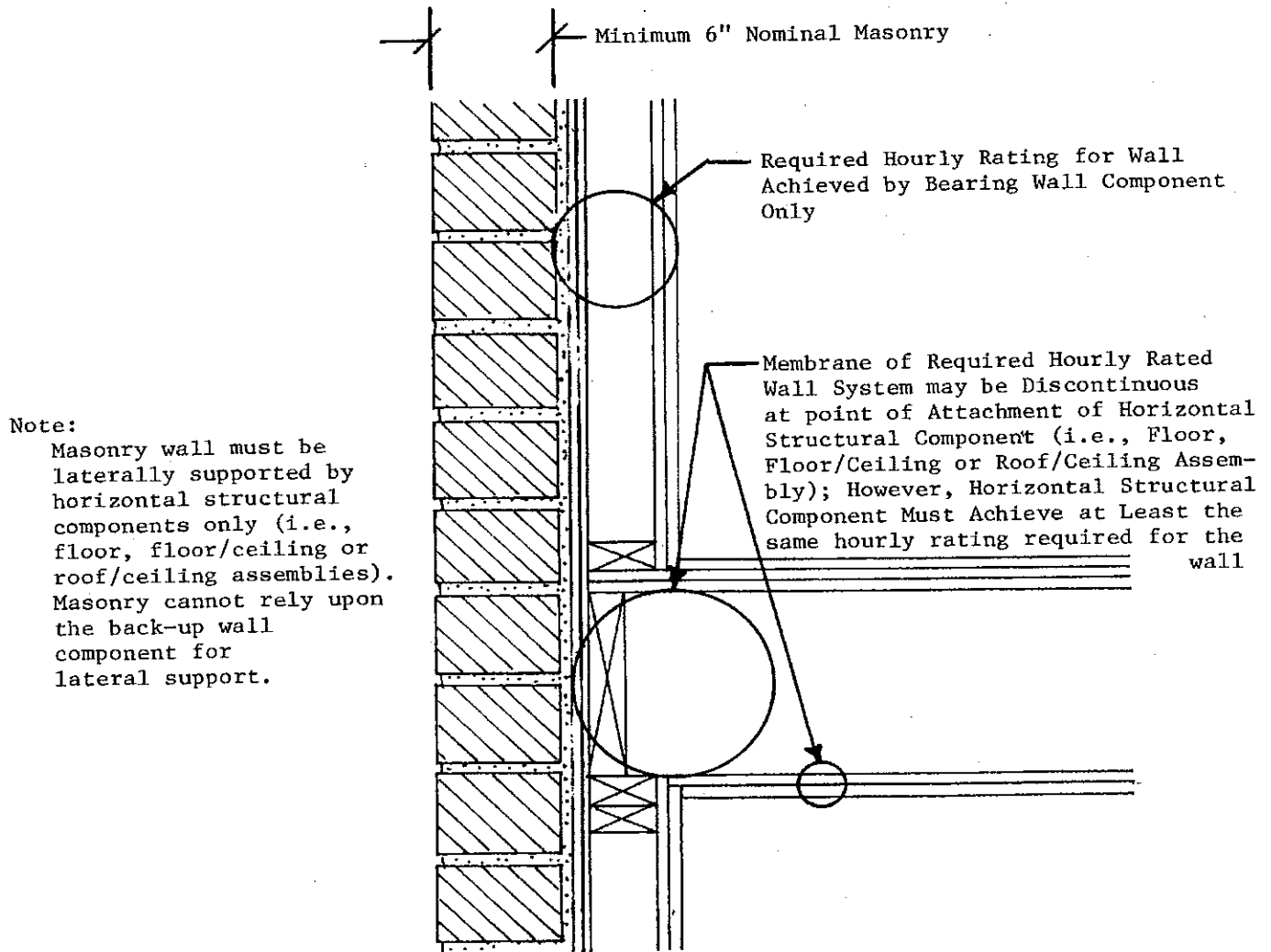
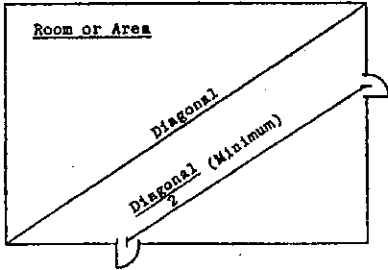


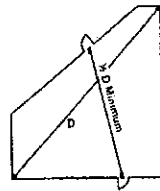
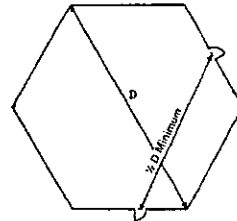
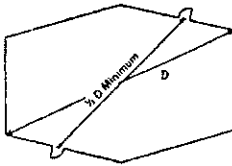
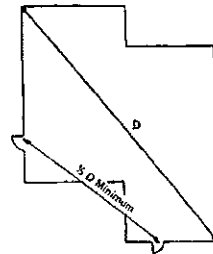
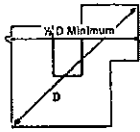
FIGURE 5B
Combination Masonry/Frame Wall
(Bearing and Non-Bearing Condition)

A-51.151 EXIT DISTRIBUTION. The following diagrams are provided to aid building designers in determining proper exit distribution:

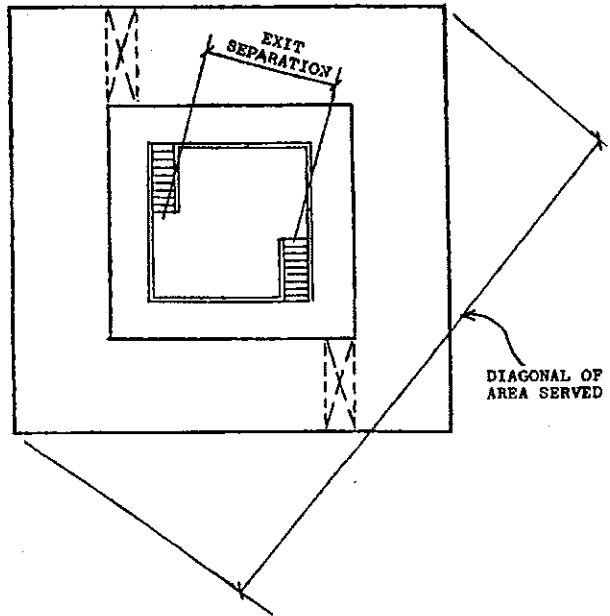
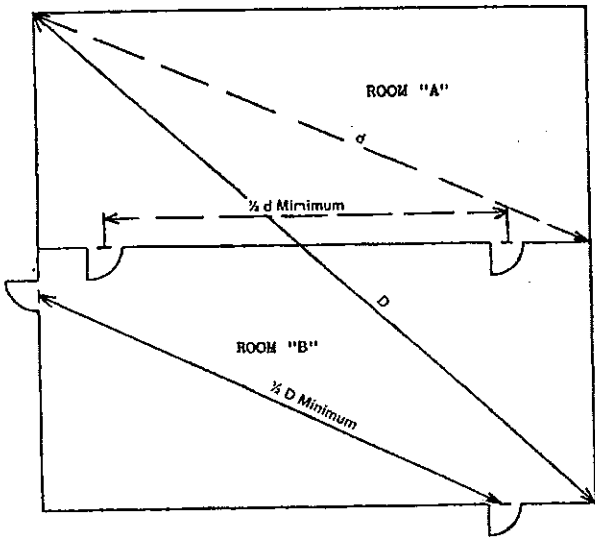
ARRANGEMENT OF EXITS



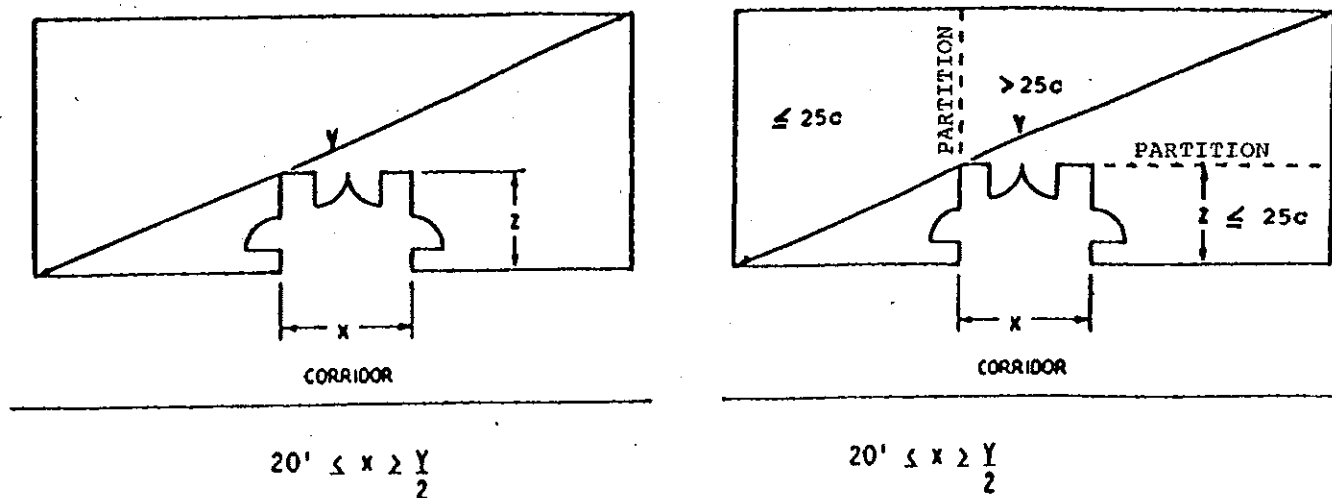
Minimum Distance = One-half of Diagonal



(Not to scale.)



A-51.152 EGRESS CONFIGURATIONS. The following diagrams are provided to aid building designers in determining proper egress configurations:



A-51.22 FIRE EXTINGUISHERS. The following information is taken from the National Fire Protection Association Standard #10-1988 - Portable Fire Extinguishers. The information is provided to assist building designers in determining the number, type and location of fire extinguishers needed to comply with the provisions of the standard.

1-4 CLASSIFICATION AND RATINGS OF FIRE EXTINGUISHERS.

1-4.1 Portable fire extinguishers are classified for use on certain classes of fires and rated for relative extinguishing effectiveness at a temperature of plus 70°F by testing laboratories. This is based upon the preceding classification of fires and the fire-extinguishing potentials as determined by fire tests.

1-4.2 The classification and rating system described in this standard is that used by Underwriters Laboratories, Inc., and Underwriters Laboratories of Canada and is based on extinguishing pre-planned fires of determined size and description as follows:

Class A Rating — Wood and excelsior.

Class B Rating — Two-inch depth n-heptane fires in square pans.

Class C Rating — No fire test. Agent must be a nonconductor of electricity.

Class D Rating — Special tests on specific combustible metal fires.

1-5 CLASSIFICATION OF HAZARDS

1-5.1 Light (low) hazard. Light hazard occupancies are locations where the total amount of Class A combustible materials, including furnishings, decorations and contents, is of minor quantity. This may include some buildings or rooms occupied as offices, classrooms, churches, assembly halls, etc. This classification anticipates that the majority of contents items are either noncombustible or so arranged that a fire is not likely to spread rapidly. Small amounts of Class B flammables used for duplicating machines, art departments, etc., are included provided that they are kept in closed containers and safely stored.

1-5.2 Ordinary (moderate) hazard. Ordinary hazard occupancies are locations where the total amount of Class A combustibles and Class B flammables are present in greater amounts than expected under light (low) hazard occupancies. These occupancies could consist of offices, classrooms, mercantile shops and allied stor-

age, light manufacturing, research operations, auto showrooms, parking garages, workshop or support service areas of light (low) hazard occupancies and warehouses containing Class I or Class II commodities as defined by NFPA 231, Standard for General Storage.

1-5.3 Extra (high) hazard. Extra hazard occupancies are locations where the total amount of Class A combustibles and Class B flammables present, in storage, production use, and/or finished product is over and above those expected and classed as ordinary (moderate) hazards. These occupancies could consist of wood-working, vehicle repair, aircraft and boat servicing, individual product display showrooms, product convention center displays, storage and manufacturing processes such as painting, dipping, coating, including flammable liquid handling. Also included is warehousing of, or in-process storage of other than Class I and Class II commodities.

3-2 FIRE EXTINGUISHER SIZE AND PLACEMENT FOR CLASS A HAZARDS.

3-2.1 Minimal sizes of fire extinguishers for the listed grades of hazards shall be provided on the basis of Table 3-2.1 except as modified by 3-2.3. Extinguishers shall be located so that the maximum travel distances shall not exceed those specified in Table 3-2.1, except as modified by 3-2.3.

3-2.1.1 Certain smaller extinguishers which are charged with multipurpose dry chemical or Halon 1211 are rated on Class B and Class C fires, but have insufficient effectiveness to earn the minimum 1-A rating even though they have value in extinguishing smaller Class A fires. They shall not be used to meet the requirements of 3-2.1.

3-2.2 Up to one-half of the complement of extinguishers as specified in Table 3-2.1 may be replaced by uniformly spaced 1½ inch hose stations for use by the occupants of the building. When hose stations are so provided they shall conform to NFPA 14, Installation of Standpipe and Hose Systems. The location of hose stations and the placement of fire extinguishers shall be in such a manner that the hose stations do not replace more than every other extinguisher.

3-2.3 Where the floor area of a building is less than that specified in Table 3-2.1, at least one extinguisher of the minimum size recommended shall be provided.

3-2.4 The protection requirements may be fulfilled with extinguishers of higher rating provided the travel distance to such larger extinguishers shall not exceed 75 feet.

Table 3-2.1

	Light (Low) Hazard Occupancy	Ordinary (Moderate) Hazard Occupancy	Extra (High) Hazard Occupancy
Minimum rated single extinguisher	2-A	2-A	4-A*
Maximum floor area per unit of A	3,000 sq. ft.	1,500 sq. ft.	1,000 sq. ft.
Maximum floor area for extinguisher	11,250 sq. ft.	11,250 sq. ft.	11,250 sq. ft.
Maximum travel distance to extinguisher	75 ft.	75 ft.	75 ft.

*Two 2 1/2 gal water type extinguishers can be used to fulfill the requirements of one 4-A rated extinguisher.

A-52.011 HAZARD CLASSIFICATIONS. The following information is provided to assist building owners and designers in determining the hazard classifications of typical building usage or occupancy:

HAZARD CLASSIFICATION	DESCRIPTION OF FUEL LOAD	TYPICAL EXAMPLES
Low Hazard	Buildings or structures used for the manufacture or storage of noncombustible or low hazard materials, that do not ordinarily burn rapidly, such as but not limited to: asbestos; chalk; non-alcoholic beverages; brick and masonry; ceramic products; gypsum; glass and metals; foods in noncombustible containers; fresh fruits and vegetables in non-plastic containers; dairy products in non-wax coated paper containers; beer or wine in metal or glass containers; electrical motors and coils; and fertilizer.	Metal fabricating and assembly; foundries; water pumping and waste water treatment plants; fertilizer storage; telephone exchanges; freezer warehouses; storage in closed front metal cabinets; storage of noncombustible or low hazard materials on wood pallets or in paper cartons without significant amounts of combustible wrappings; and similar occupancies with slight combustibles.
Moderate Hazard	Buildings and structures used for the manufacture or storage of moderate hazard materials, which are likely to burn with moderate rapidity, but which do not produce either poisonous gases, fumes or explosives, such as but not limited to: cloth, burlap and paper bags; bamboo and rattan; canvas and leather belting; baskets; books and paper in rolls or packs; boots and shoes; cardboard and cardboard boxes; clothing; cordage; furniture; furs; glue, mucilage, paste and size; linoleum; silk; soap; sugar; tobacco products; wax candles; athletic equipment; musical instruments; beverages containing more than 12% alcohol; furniture other than metal; business machines; electronics; and plastic products not classified as high hazard.	Mercantile storage and display; offices; school-rooms; auto showrooms; aircraft storage; light manufacturing; school shop areas; leather enameling or japanning operations; grain elevators with less than one million bushel bulk storage capacity; livestock shelters; fertilizer bagging operations; feed, flour and grist mills; lumber yards; motor vehicle repair shops; petroleum warehouses for storage of lubricating oils with a flash point of 200°F. or higher; photo engraving operations; public garages; stables; upholstery and mattress manufacturing; aircraft servicing; woodworking and millworking; bakeries; boat building operations; food processing; condensed and powdered milk manufacturing; paper mills or products; printing or publishing; refuse incinerators; and textile mills.
High Hazard	Buildings and structures used for the storage, manufacture or processing of: highly combustible or explosive products or materials, which are likely to burn with extreme rapidity or which may produce poisonous fumes or explosions; highly corrosive, toxic or noxious alkalies, acids or other liquids or chemicals producing flame, fumes, poisonous, irritant or corrosive gases; materials producing explosive mixtures or dusts or which result in the division of matter into fine particles subject to spontaneous ignition.	Ammunition, explosive and firework manufacture; artificial flowers and synthetic leather manufacture; celluloid and celluloid products; cotton batting and waste processes; dry cleaning establishments using or storing more than 3 gallons of flammable liquids with a flash point below 100°F. or more than 60 gallons of flammable liquids with a flash point between 100°F. and 140°F.; feather renovating; fruit ripening processes; grain elevators with one million bushel or more bulk storage capacity; hydrogenation processes; match manufacture and storage; metal enameling and japanning; nitro-cellulose film exchanges and laboratories; paint and varnish manufacture; petroleum manufacture; processing of paper or cardboard in loose form; pyroxylin product storage and manufacture; smoke houses; factories or warehouses where loose combustible fibers or dust are manufactured, processed, generated or stored; handling or using flammable liquids under conditions involving possible release of flammable vapors; and fabrication facilities and research and development areas in which hazardous production materials are used.

A-52.07 (11) ACCEPTANCE OF THE ATRIUM SMOKE CONTROL SYSTEM. The following is a reprint of an approved test procedure:

Acceptance test procedure for the atrium smoke management system.

1. All testing shall be in the presence of a representative from the department.
2. All exhaust and supply-air systems shall be operationally balanced and tested. Complete air-balance reports shall be recorded on each piece of equipment, all exhaust inlets, and all supply outlets.
3. Each automatic initiating device shall be tripped to observe proper function. This test shall be performed on both normal and emergency power.
4. Each manual switch and override shall be tripped to observe proper function. This test shall be performed on both normal and emergency power.
5. All indicator lights shall display the appropriate detection and operating status.
6. Select a location on the first floor approximately 5 ft. outside the perimeter of the atrium opening. The location shall be acceptable to the department's representative.
7. Prepare three two-minute smoke bombs.
8. Ignite all three smoke bombs. When they become fully active, manually activate the atrium smoke-management system.
9. Observe and record the results.
10. After all smoke has been cleared, select an additional location on an upper level acceptable to the department's representative.

11. Prepare three more two-minute smoke bombs.

12. Ignite all three smoke bombs. When they become fully activated, again manually activate the atrium smoke-management system.

13. Observe and record the results.

14. Acceptable performance shall be movement of the smoke from the source into the atrium and out through exhaust at the top of the atrium. Smoke migration down the corridors shall be limited to no more than a light haze at a point 25 ft from the source. Furthermore, the balconies around the perimeter of the atrium shall maintain a smoke-free zone.

15. Upon the successful completion of these tests, a signed and dated copy of the department's acceptance shall be filed with the test records and a copy shall be maintained with the quarterly test log.

16. A copy of this acceptance test procedure and all plans, specifications, and calculations for the building shall be maintained with the quarterly test log.

A-52.20 Chapter Comm 16, Wisconsin State Electrical Code, Volume 2, requires the installation of standby emergency power for certain occupancies; the following is a reprint of s. Comm 16.46 (1):

(1) WHERE REQUIRED. Standby emergency power of a type recognized by NEC 700-12 (a), (b), (c) or (f) shall be provided as a source of supply for required exit lights, emergency lighting or power in occupancies where people are housed, assembled or confined with a capacity or area equal to or greater than those listed in Column B of Table 16.46.

**TABLE 16.46
OCCUPANCIES REQUIRING STANDBY EMERGENCY POWER**

Column A Occupancy	Column B Calculated Capacity or Area
1. Apartment buildings	50 bedrooms, including efficiency units
2. Arenas	800 square feet (Use seated space only)
3. Art galleries	20,000 square feet
4. Assembly halls such as church dining rooms and fellowship halls, dance halls, banquet halls, dining rooms, restaurants, taverns, night clubs, school and day care center multi-purpose rooms, and similar occupancies	2,000square feet
5. Assembly halls with stage	1,400 square feet
6. Auditoriums	1,400 square feet
7. Banks	30,000 square feet
8. Bowling alleys	200 persons based on 5 persons per alley plus number of spectator seats and 10 square feet per person for bar and dining areas
9. Centers for developmentally disabled	20 inmate beds
10. Children's homes	20 beds
11. Community-based residential facilities	20 beds
12. Convents	200 beds
13. Dormitories, including those used in detention schools	200beds
14. Exhibition buildings	12,000 square feet
15. Factories	30,000 square feet
16. Field houses	800 square feet (Use seated space only)
17. Gymnasiums	200 persons based on 6 square feet per person for seated space and 15 square feet per person for unseated space
18. Hospitals	20 patient beds
19. Hotels	200 rooms
20. Jails	20 inmate beds
21. Lecture halls	1,400 square feet
22. Libraries	200 persons based on 20 square feet per person for reading rooms and 100 square feet per person for balance
23. Lodge halls	200 persons based on 6 square feet per person for seated space and 15 square feet per person for unseated space
24. Motels	100 rooms
25. Museums	20,000 square feet
26. Nursing homes	20 patient beds
27. Office buildings	30,000 square feet
28. Rooming houses	200 rooms
29. Skating rinks	3,000 square feet
30. Stores	200 persons based on 30 square feet per person for first floor and 60 square feet per person for second floor and above
31. Swimming pools (indoor)	450 square feet
32. Theaters and theater lobbies	1,400 square feet (Theater and lobby must be combined in determining total area)
33. Warehouses	120,000 square feet

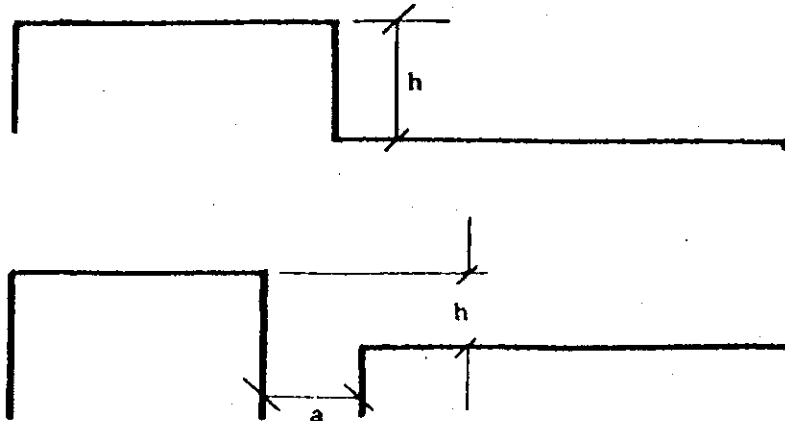
A-52.60 (1) WATER CLOSETS. The following is a reprint of s. Comm 84.20 (5) (m) 7. from the plumbing code:

7. A water closet may not be located closer than 15 inches from its center to any side wall, partition, vanity, or other obstruction, nor closer than 30 inches center to center, between water closets.

There shall be at least 24 inches clearance in front of a water closet to any wall, fixture or door.

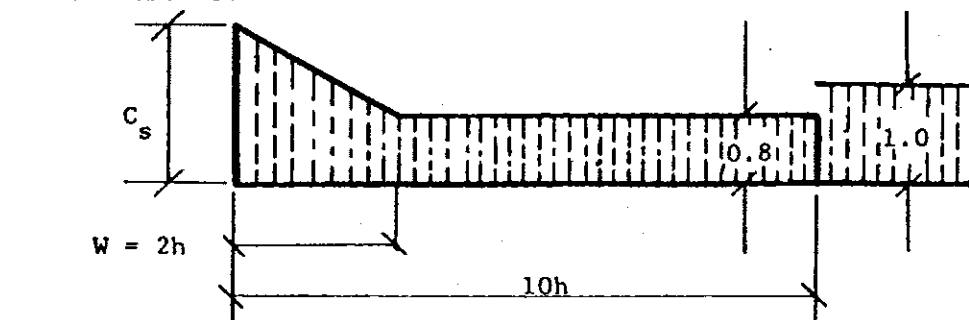
A-53.11 (4) (c) Increase in roof loads. The following design provisions may be used to determine the increase in roof loads as required by this section.

ROOF SHAPES



Lower level of multi-level roofs (when upper roof is part of the same building or on an adjacent building not more than 15 feet away).

SNOW LOAD DISTRIBUTIONS AND COEFFICIENTS, LIMITATIONS



$$C_s = 15 \frac{h}{g}$$

when $15 \frac{h}{g} < 1.0$ use $C_s = 1.0$

when $15 \frac{h}{g} > 3.0$ use $C_s = 3.0^*$

$$W = 2h$$

when $h < 5$ ft use $W = 10$

$h > 15$ ft use $W = 30$

h = difference of roof heights in ft.

g = roof live load in psf [ILHR 53.11 (4)]

w = width of drift from higher building in ft.

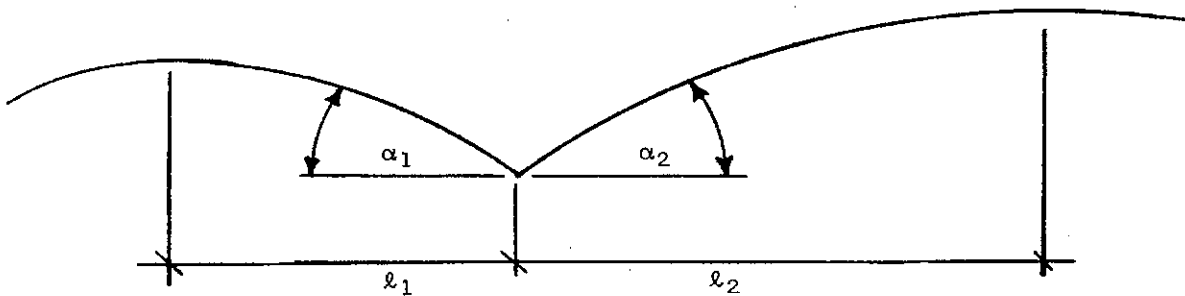
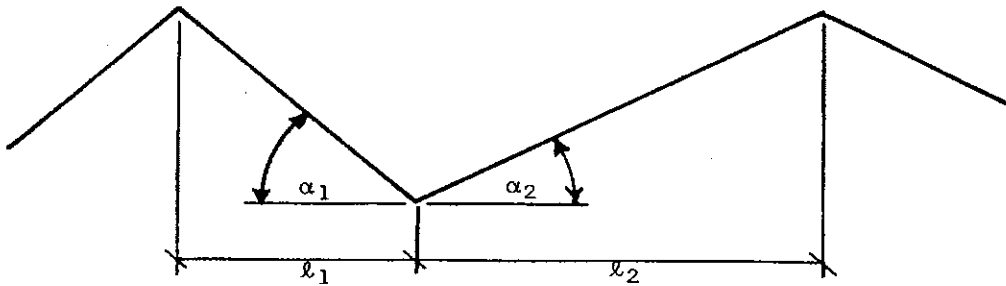
a = distance between buildings < 15 ft.

Design upper roof for loads applicable to single-level roofs.

*An upper limit of 3 times the basic roof load has been suggested. It should be noted, however, that higher loads have been observed where an upper roof was very long (measured perpendicularly to the step between the upper and lower roofs). On the other hand, for relatively short upper roofs (say less than 50 ft), a reduction below the calculated C_s value may be judged adequate by the designer.

ROOF SHAPES

Valley areas of two-span and multi-span sloped or curved roofs

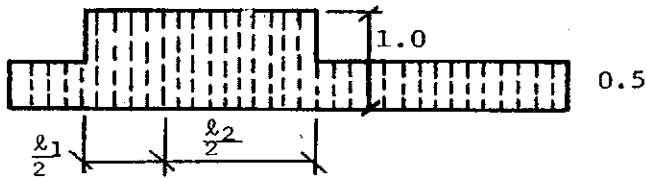


SNOW LOAD DISTRIBUTIONS AND COEFFICIENTS, LIMITATIONS

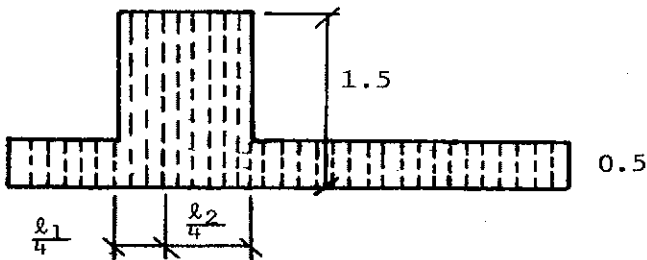
CASE I



CASE II

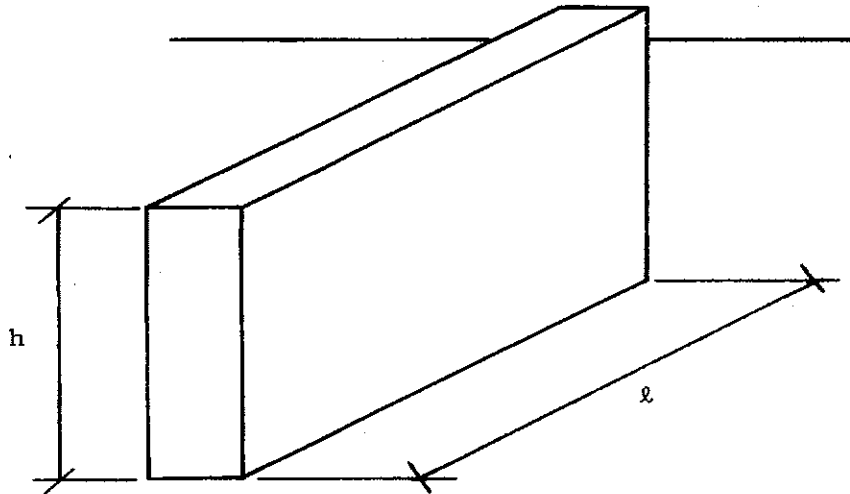


CASE III



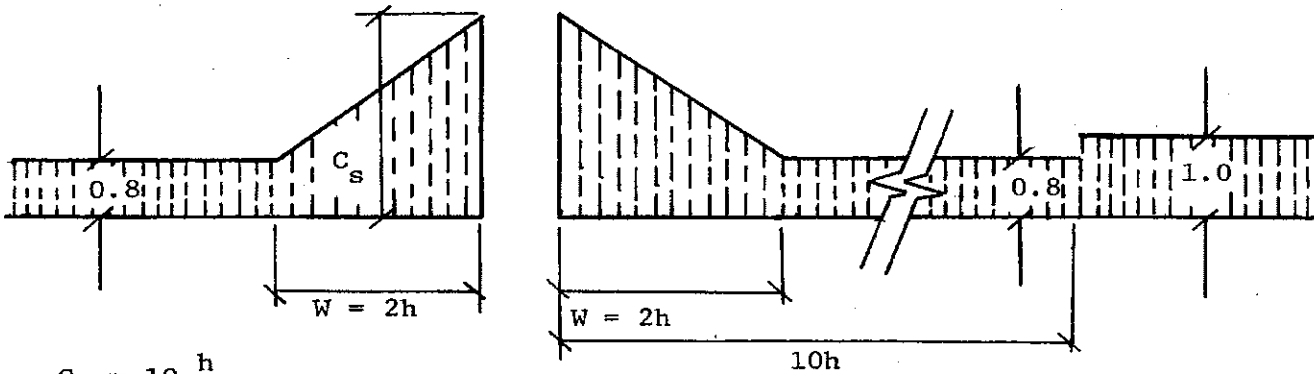
For both α_1 and $\alpha_2 \leq 10^\circ$ use Case I only; otherwise use Case I, II and III

ROOF SHAPES



Roof areas adjacent to projections and obstructions on roofs

SNOW LOAD DISTRIBUTIONS AND COEFFICIENTS, LIMITATIONS



$$C_s = 10 \frac{h}{g}$$

when $10 \frac{h}{g} < 1.0$ use $C_s = 1.0$

when $10 \frac{h}{g} > 2.0$ use $C_s = 2.0$

when $l < \frac{g}{6}$ use $C_s = 1.0$

$$W = 2 h$$

when $h < 5$ ft use $W = 10$

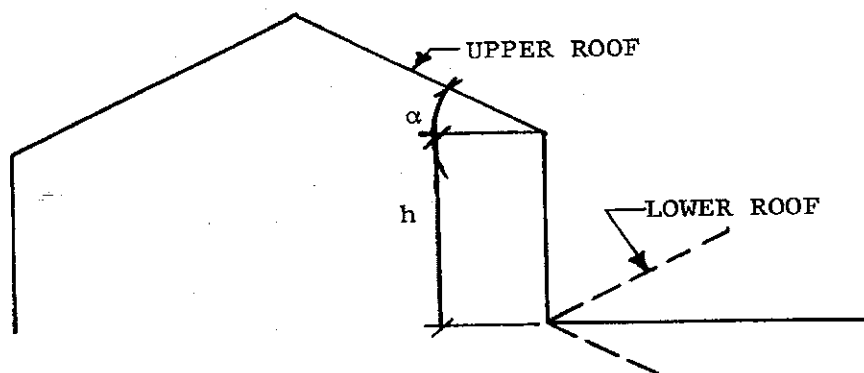
when $h > 15$ ft use $W = 30$

h = height of projection in ft.

g = roof live load in psf

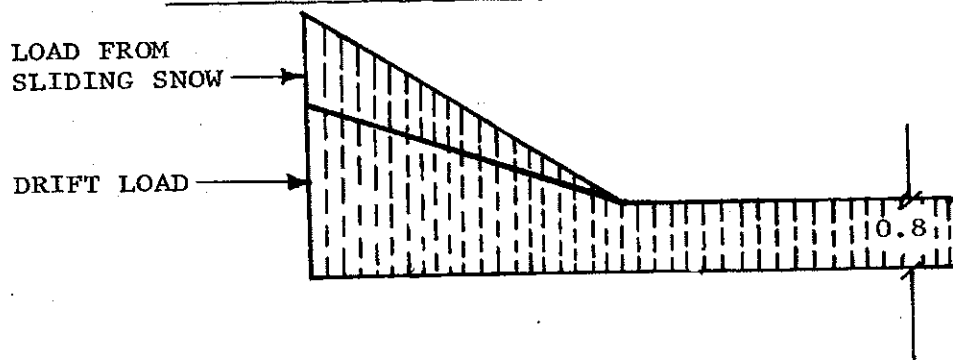
w = width of snow drift in ft.

l = length of projection in ft.



Lower of multi-level roofs with upper roof sloped towards lower roof, where α exceeds 10° .

SNOW LOAD DISTRIBUTIONS AND COEFFICIENTS, LIMITATIONS



Design lower roof for loads applicable to multi-level roof plus a portion of the sliding snow from the upper roof.*

Design upper roof for loads applicable to single-level roofs.

*Where snow is likely to slide onto a lower roof from an upper roof, the lower roof should be designed for the load as provided for multi-level roofs plus an additional load produced by the snow that may slide from the upper roof. It is not possible to provide coefficients for this situation, but the following guide is recommended. Because of the remote probability that both upper and lower roofs will have their full load over the full areas simultaneously when sliding occurs, it may be assumed that the lower roof would be carrying its full load and that sliding of 50% of the total weight of the applicable uniformly distributed snow load from the upper roof would occur.

A-53.11 (4) (d) ROOF DESIGNED FOR CONTROL FLOW DRAINAGE. This section refers to the requirements of the Plumbing Code (ch. Comm 82) for storm drain sizes where control flow drainage roof design is used. The following information from the plumbing code is provided for use by the building designer:

Partial Reprint of s. Comm 82.36 (4) and (5)

(4) LOAD ON DRAIN PIPING. (a) *Storm water drainage.* The load factor on storm water drain piping shall be computed in terms of gallons per minute or on the square footage of the horizontal projection of roofs, paved areas, yards and other tributary areas.

(b) *Continuous flow devices.* Where there is a continuous or semi-continuous discharge into the storm building drain or storm building sewer, as from a pump, air conditioning unit, or similar device, each gallon per minute of such discharge shall be computed as being equivalent to 26 square feet of roof area.

(5) SELECTING SIZE OF STORM AND CLEAR WATER DRAIN PIPING. (a) *Horizontal storm water drain piping.* The pipe size for horizontal drain piping for storm water shall be determined from Tables 82.36-1 to 82.36-4.

**Table 82.36-1
MINIMUM SIZE OF STORM WATER HORIZONTAL
DRAIN PIPING ROOF AREAS**

Pipe Diameters (in inches)	Maximum Roof Areas (in square feet)			
	Pitch of Piping Per Foot			
	1/16 inch	1/8 inch	1/4 inch	1/2 inch
3	650	910	1,300	1,820
4	1,300	1,950	2,990	3,770
5	2,470	3,640	5,070	7,020
6	4,160	5,980	8,320	11,700
8	9,320	13,000	18,200	26,000
10	17,680	24,700	33,800	50,440
12	27,300	41,080	57,200	81,900
15	52,000	72,800	105,300	146,640
18	85,800	121,550	174,200	247,000
21	156,520	179,660	256,880	374,400
24	187,200	261,560	382,200	546,000

Divide square footage by 26 to obtain flow in gpm.

**Table 82.36-4
MAXIMUM CAPACITY OF STORM WATER
HORIZONTAL DRAIN PIPING FLOWING FULL**

Pipe Diameters (in inches)	Maximum Capacities in Gallons Per Minute			
	Pitch of Piping Per Foot			
	1/16 inch	1/8 inch	1/4 inch	1/2 inch
3	25	35	50	70
4	50	75	115	145
5	97	140	195	270
6	160	230	320	450
8	355	500	700	1,000
10	680	950	1,300	1,940
12	1,050	1,580	2,200	3,150
15	2,000	2,800	4,050	5,640
18	3,300	4,675	6,700	9,500
21	6,020	6,910	9,880	14,400
24	7,200	10,060	14,700	21,000

(b) *Vertical conductors for storm water.* 1. A vertical conductor for storm water shall not be smaller than the largest horizontal branch connected thereto.

2. Vertical conductors shall be sized in accordance with Table 82.36-5 or the diameter D, where

$$D = 1.128 \sqrt{\frac{A}{X}}$$

Where,

- A = the area of the roof in square feet
- X = 300 square feet per square inch for a roof covered with gravel or slag and with a pitch not exceeding 1/4 inch per foot; or
- = 250 square feet per square inch for a roof covered with gravel or slag and with a pitch of greater than 1/4 inch per foot; or
- = 200 square feet per square inch for a roof with a metal, tile, brick or slate covering and of any pitch.

Table 82.36-5
MINIMUM DIAMETER OF VERTICAL CONDUCTORS

Type of Roof	Maximum Roof Areas (in square feet)					
	Pipe Diameters (in inches)					
	2 1/2	3	4	5	6	8
Roofs covered with gravel, slag, or similar material and with a pitch of 1/4" per foot or less.	1,645	2,120	3,780	5,885	8,490	15,125
Roofs covered with gravel, slag or similar material and with a pitch greater than 1/4" per foot.	1,220	1,770	3,150	4,905	7,075	12,600
Roofs covered with metal, tile, brick, slate or similar material and of any pitch.	975	1,415	2,520	3,925	5,660	10,080

Divide square footage by 26 to obtain flow in gpm.

A-53.15 LOAD COMBINATIONS. It is the intent of this section that the loads specified in ss. Comm 53.10 through 53.14 be considered to act in the following combinations, whichever is critical, for the design of the building frame, foundation or structural member:

1. Dead load plus live load.
2. Dead load plus wind load.
3. Dead load plus live load plus wind load.
4. Dead load plus live load plus crane loads.

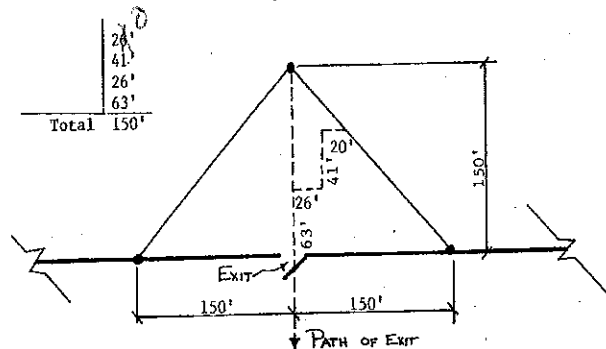
Distribution of live loads which would cause the maximum shear, bending moment or stress in structural members should be investigated.

A-54.02 (4) EXIT DISTANCE. The following illustrations and text are provided to explain the procedure and intent of using the triangulation method of exit distance determination.

Exit travel must terminate at one of the following types of exits:

1. Standard exit to grade (Comm 51.15)
2. Enclosed stairways (Comm 51.17 and 51.18)
3. Horizontal exits (Comm 51.19)
4. Fire escapes (Comm 51.20)

Therefore, exit distance must be measured from one of these exit types. All exits must lead to a street, alley or open court which is connected to a street or alley.



Procedure:

1. Beginning at designated exit type, measure required exit distance (150 feet, for example) at right angles to and parallel with (on both sides) the exit.
2. Connect end points to form the "exit triangle".

3. All areas within the triangle are within the required exit distance when traveling toward or at right angles to the exit.

4. All the interior space of a building must fall within the "exit triangles" formed by using the required exits for the building.

5. When measuring exit distance in stairways, only the horizontal travel distance is included in the determination.

A-54.02 (4) (c) The use of the term "high hazard" as referred to in this section is intended to apply to the following list of operations and occupancies:

1. Aircraft hangars.
2. Dry cleaning establishments: using gasoline or other volatile flammable liquids.
3. Enameling or japanning.
4. Mills: sugar, starch cereal, feed, flour and grist mills.
5. Paint and varnish: manufacturing, storing, handling, spraying, and other related operations.
6. Proxylin products: manufacture and storage.
7. Repair garages.
8. Smoke houses.
9. Storage of: explosive gases under pressure (15 psi and over 2500 cubic feet) such as acetylene, hydrogen, natural gas, etc.
10. Storage of: materials with a flash point under 200° F. such as celluloid products, kerosene, oils, etc.
11. Woodworking establishments.

A-57.02 (2) (b) VERTICAL DIVISION WALLS. See drawings and illustrations in s. A 51.03 (5) (a) for typical floor/ceiling-wall connection details for vertical division walls. Disregard masonry components shown in drawings when masonry is not used in the construction of the vertical division wall.

A-57.07 (3) CHANGES OF ELEVATION WITHIN INDIVIDUAL LIVING UNITS. Section Comm 57.07 (3) permits the steps, stairs and ramps within individual living units to conform with s. Comm 21.04 of the Uniform Dwelling Code. The following is a reprint of the applicable portions of that section:

Comm 21.04 Stairs. Every exterior or interior stairs, except those leading to attics or crawl space or similar non-habitable spaces, shall conform to the requirements of this section.

(1) LANDINGS. (a) *Intermediate landings.* Intermediate landings located in a flight of stairs shall be at least as wide as the stairs and shall measure at least 3 feet in the direction of travel. Trim and handrails may project no more than 3 1/2 inches into the required width.

(b) *Landings at the top and base of stairs.* A level landing shall be provided at the top and at the foot of every stairs. The landing

shall be at least as wide as the stairs and shall measure at least 3 feet in the direction of travel.

(c) *Doors at landings.* Except as provided in subds. 1 to 4, level landings shall be provided on each side of any door located at the foot or head of a stairway, regardless of the door swing. In the application of the exceptions given in subds. 1 to 4, stairways to attached garages or porches are considered to be interior stairways.

1. Exception. A landing shall not be required between the door and the head of interior stairs, provided the door does not swing over the stairs.

2. Exception. A landing shall not be required between the door and the head of an interior stairway of 2 or fewer risers, regardless of doorswing.

3. Exception. A landing shall not be required between a sliding glass door and the head of an exterior stairway of 3 or fewer risers.

4. Exception. The exterior landing, platform or sidewalk at an exterior doorway shall be located not more than 8 inches below the interior floor elevation. The landing platform shall have a length at least equal to the width of the door.

(2) **HANDRAILS AND GUARDRAILS.** (a) *Handrails.* Every stairs of more than 3 risers shall be provided with at least one handrail. Handrails shall be provided on all open sides of stairways.

(b) *Guardrails.* All openings between floors, open sides of landings, platforms, balconies or porches which are more than 24 inches above grade or a floor, shall be protected with guardrails.

(c) *Handrail and guardrail details.* 1. Height. Handrails shall be located at least 30 inches, but not more than 34 inches, above the nosing of the treads. Guardrails shall be located at least 36 inches above the upper surface of the floor.

2. Open railings. Open guardrails or handrails shall be provided with intermediate rails or an ornamental pattern to prevent the passage of a sphere with a diameter larger than 9 inches.

3. Clearance. The clearance between the handrail and the wall surface shall be at least 1½ inches.

4. Loading. Handrails and guardrails shall be designed and constructed to withstand a 200 pound load applied in any direction.

5. Exterior rails. Exterior handrails and guardrails shall be constructed of metal, decay resistant or pressure treated wood or shall be protected from the weather.

(3) **STAIR DETAILS.** Stairs shall meet the following requirements:

(a) *Minimum width.* Every stairs shall measure at least 3 feet in width.

(b) *Headroom.* Every stairs shall be provided with a minimum headroom clearance of 6 feet 4 inches. The minimum clearance shall be measured vertically from a line parallel to the nosing of the treads to the ceiling or soffit directly above that line.

(c) *Treads and risers.* Risers shall not exceed 8 inches in height, measured vertically from tread to tread. Treads shall be at least 9 inches wide, measured horizontally from nosing to nosing. There shall be no variation in uniformity exceeding 3/16 inch in the width of tread or in the height of risers. No flight of stairs shall exceed 12 feet in height unless landings are provided.

(d) *Winders.* Winder steps may be used in stairs where the length of the tread is at least 3 feet and the winder tread measures at least 7 inches in width from nosing to nosing at a point one foot from the narrow end of the tread.

(e) *Spiral stairs.* Spiral stairs may be used as an exit stairs. The tread shall measure at least 26 inches from the outer edge of the supporting column to the inner edge of the handrail and at least 7

inches in width from nosing to nosing at a point one foot from the narrow end of the tread.

A-57.11 The intent of this section is to apply to floor levels not more than one story below grade (at building).

A-57.11 (1) (f) It is the intent of this subsection that each living unit needs only one means of exit from within the unit and that the entire building be provided with no less than 2 exits.

A-57.81 Requirement 1. (4) SITE IMPRACTICALITY GUIDELINES.

(2) Site impracticality. Covered multifamily dwellings with elevators shall be designed and constructed to provide at least one accessible entrance on an accessible route, regardless of terrain or unusual characteristics of the site. Covered multifamily dwellings without elevators shall be designed and constructed to provide at least one accessible entrance on an accessible route unless terrain or unusual characteristics of the site are such that the following conditions are found to exist:

(a) Site impracticality due to terrain. There are two alternative tests for determining site impracticality due to terrain: the individual building test provided in paragraph (i), or the site analysis test provided in paragraph (ii). These tests may be used as follows.

A site with a single building having a common entrance for all units may be analyzed only as described in paragraph (i).

All other sites, including a site with a single building having multiple entrances serving either individual dwelling units or clusters of dwelling units, may be analyzed using the methodology in either paragraph (i) or paragraph (ii). For these sites for which either test is applicable, regardless of which test is selected, at least 20% of the total ground floor units in nonelevator buildings, on any site, must comply with the guidelines.

(i) Individual building test. It is impractical to provide an accessible entrance served by an accessible route when the terrain of the site is such that:

(A) the slopes of the undisturbed site measured between the planned entrance and all vehicular or pedestrian arrival points within 50 feet of the planned entrance exceed 10 percent; and

(B) the slopes of the planned finished grade measured between the entrance and all vehicular or pedestrian arrival points within 50 feet of the planned entrance also exceed 10 percent.

If there are no vehicular or pedestrian arrival points within 50 feet of the planned entrance, the slope for the purposes of this paragraph (i) will be measured to the closest vehicular or pedestrian arrival point.

For purposes of these guidelines, vehicular or pedestrian arrival points include public or resident parking areas; public transportation stops; passenger loading zones; and public streets or sidewalks. To determine site impracticality, the slope would be measured at ground level from the point of the planned entrance on a straight line to (i) each vehicular or pedestrian arrival point that is within 50 feet of the planned entrance, or (ii) if there are no vehicular or pedestrian arrival points within that specified area, the vehicular or pedestrian arrival point closest to the planned entrance. In the case of sidewalks, the closest point to the entrance will be where a public sidewalk entering the site intersects with the sidewalk to the entrance. In the case of resident parking areas, the closest point to the planned entrance will be measured from the entry point to the parking area that is located closest to the planned entrance.

(ii) Site analysis test. Alternatively, for a site having multiple buildings, or a site with a single building with multiple entrances, impracticality of providing an accessible entrance served by an accessible route can be established by the following steps:

(A) The percentage of the total buildable area of the undisturbed site with a natural grade less than 10% slope shall be calculated. The analysis of the existing slope (before grading) shall be done

on a topographic survey with two foot (2') contour intervals with slope determination made between each successive interval. The accuracy of the slope analysis shall be certified by a professional licensed engineer, landscape architect, architect or surveyor.

(B) To determine the practicality of providing accessibility to planned multifamily dwellings based on the topography of the existing natural terrain, the minimum percentage of ground floor units to be made accessible should equal the percentage of the total buildable area (not including floodplains, wetlands, or other restricted use areas) of the undisturbed site that has an existing natural grade of less than 10% slope.

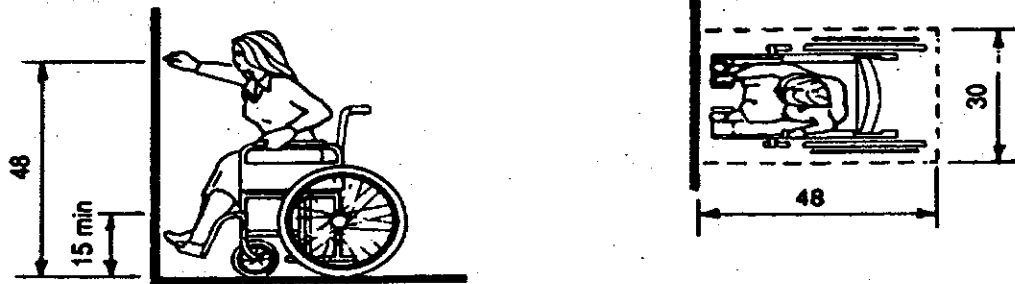
(C) In addition to the percentage established in paragraph (B), all ground floor units in a building, or ground floor units served by a particular entrance, shall be made accessible if the entrance to the units is on an accessible route, defined as a walkway with a slope between the planned entrance and a pedestrian or vehicular arrival point that is no greater than 8.33%.

(b) Site impracticality due to unusual characteristics. Unusual characteristics include sites located in a federally-designed floodplain or coastal high-hazard area and sites subject to other similar requirements of law or code that the lowest floor or the lowest structural member of the lowest floor must be raised to a specified level at or above the base flood elevation. An accessible route to a building entrance is impractical due to unusual characteristics of the site when:

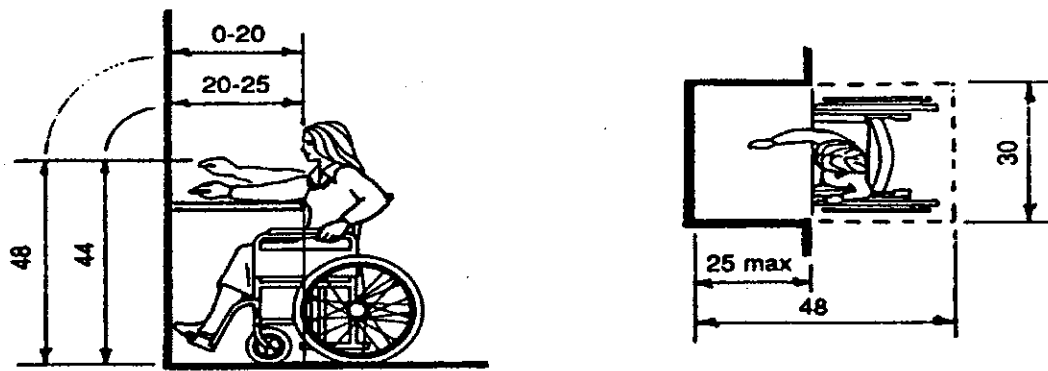
(i) the unusual site characteristics result in a difference in finished grade elevation exceeding 30 inches and 10 percent measured between an entrance and all vehicular or pedestrian arrival points within 50 feet of the planned entrance; or

(ii) if there are no vehicular or pedestrian arrival points within 50 feet of the planned entrance, the unusual characteristics result in a difference in finished grade elevation exceeding 30 inches and 10 percent measured between an entrance and the closest vehicular or pedestrian arrival point.

A-57.85 REACH DIMENSIONS OVER AN OBSTRUCTION.

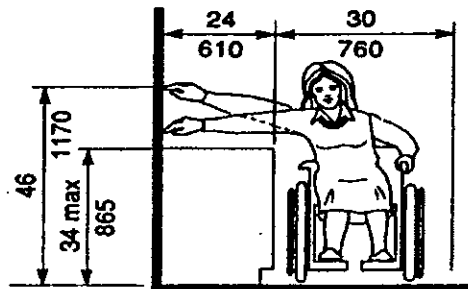


(a) Forward Reach Limit



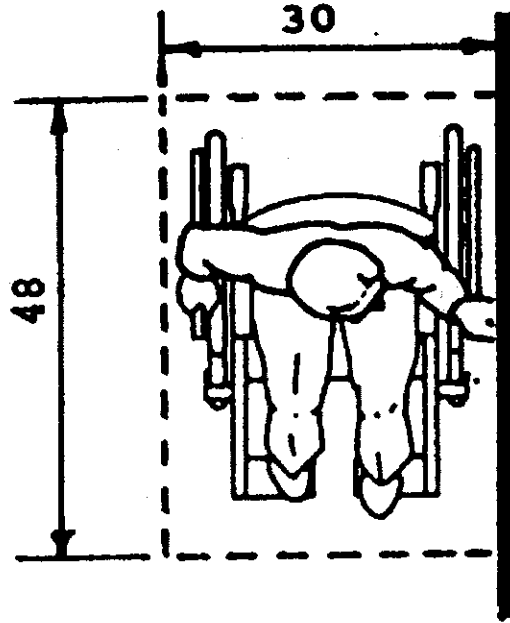
NOTE: Clear knee space should be as deep as the reach distance.

(b) Maximum Forward Reach Over an Obstruction

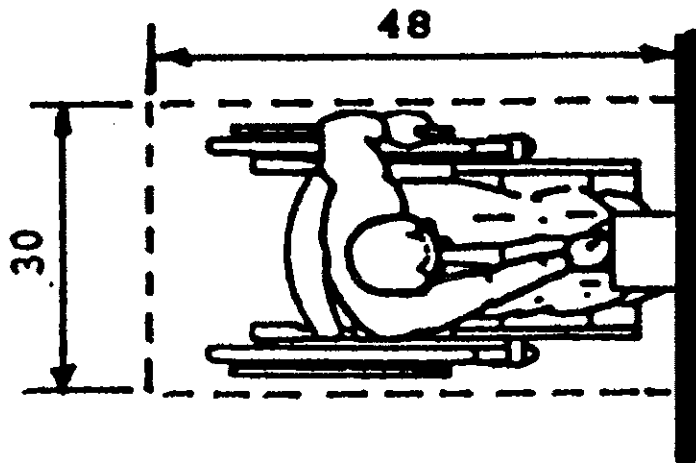


(c) Maximum Side Reach Over Obstruction

A-57.87 Usable kitchens. MINIMUM CLEAR FLOOR SPACE FOR WHEELCHAIRS.

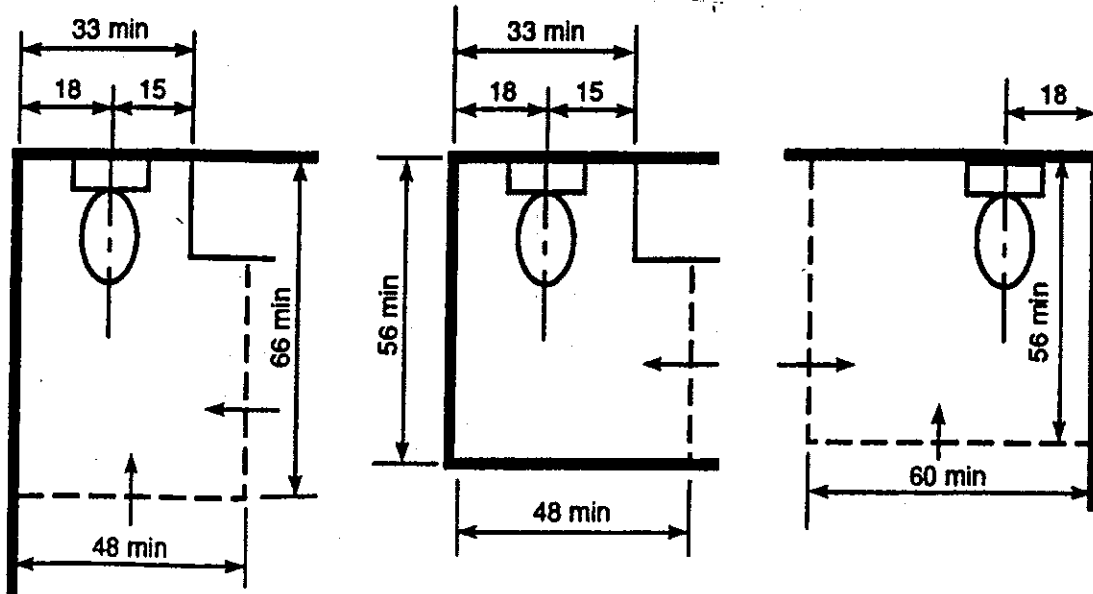


(a) Parallel Approach



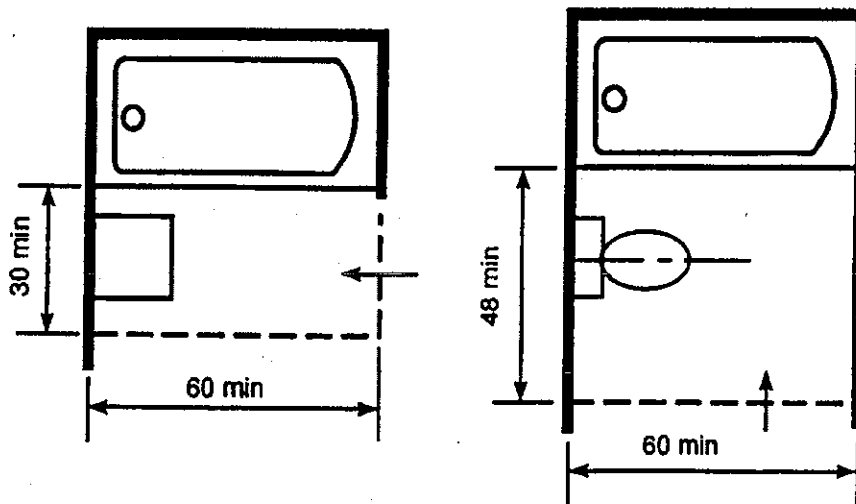
(b) Forward Approach

A-57.871 (1) BASIC USABILITY AND 57.871 (2) HIGHER LEVEL OF USABILITY: CLEAR FLOOR SPACE FOR WATER CLOSETS.



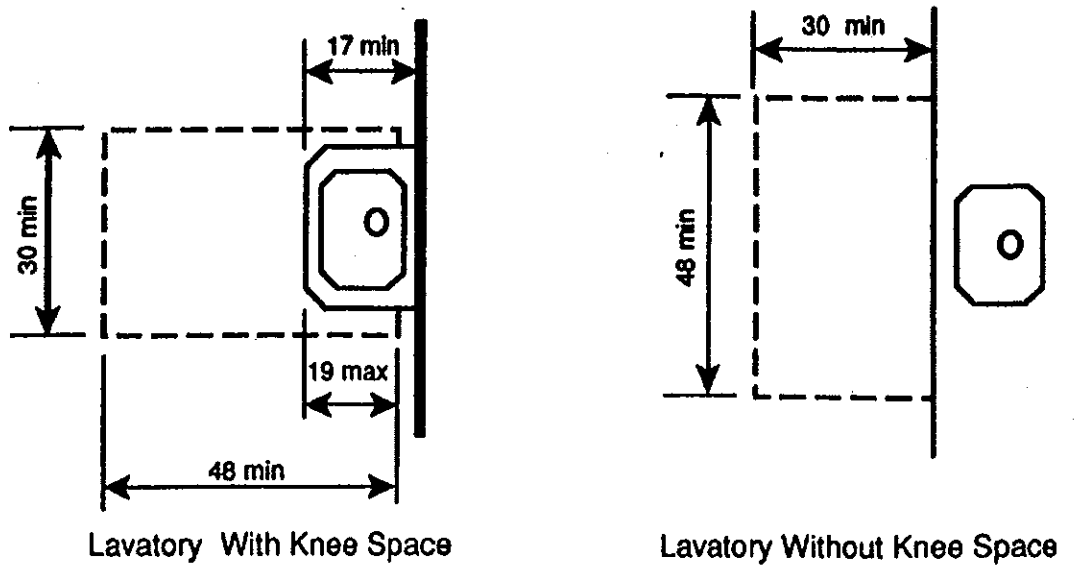
Clear Floor Space for Water Closets

A-57.871 (1) BASIC USABILITY: CLEAR FLOOR SPACE AT BATHTUBS.



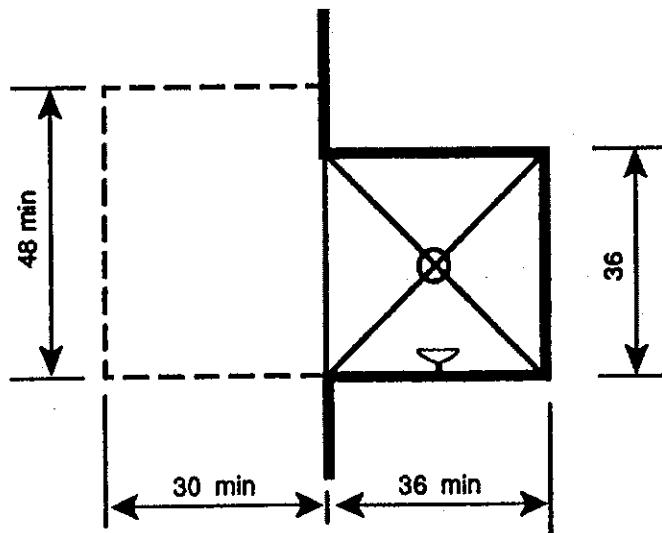
Clear Floor Space at Bathtubs

A-57.871 (1) BASIC USABILITY AND 57.871 (2) HIGHER LEVEL OF USABILITY: CLEAR FLOOR SPACE AT LAVATORIES.



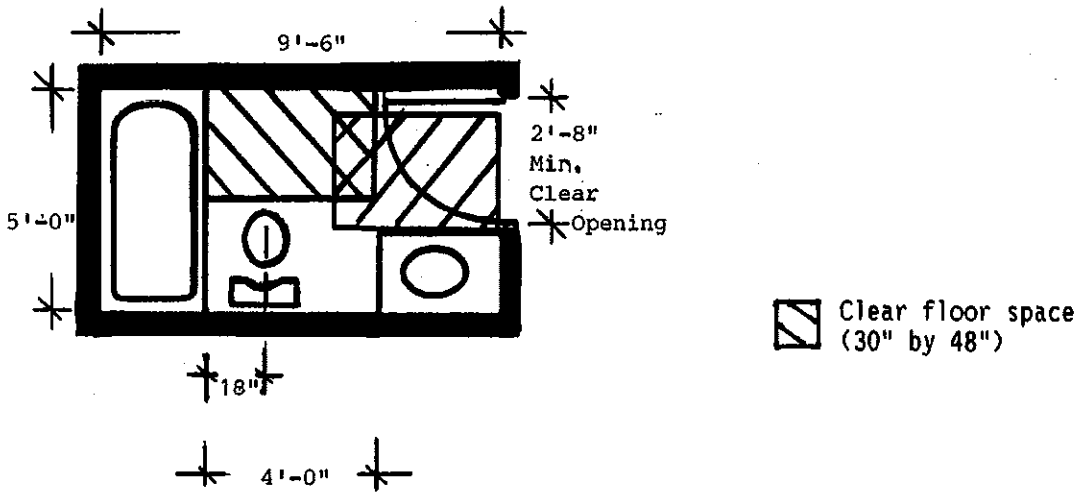
Clear Floor Space at Lavatories

A 57.871 (1) BASIC USABILITY AND 57.871 (2) HIGHER USABILITY: CLEAR FLOOR SPACE AT SHOWERS.

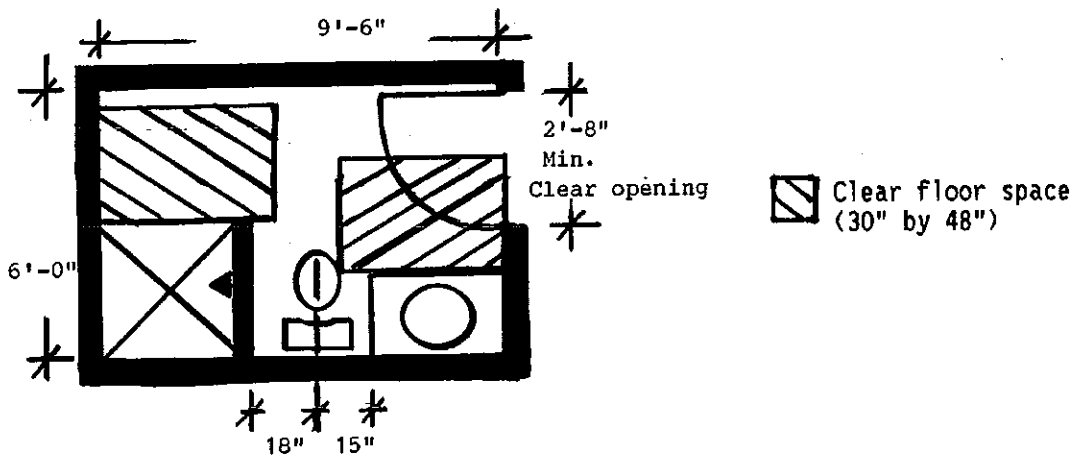
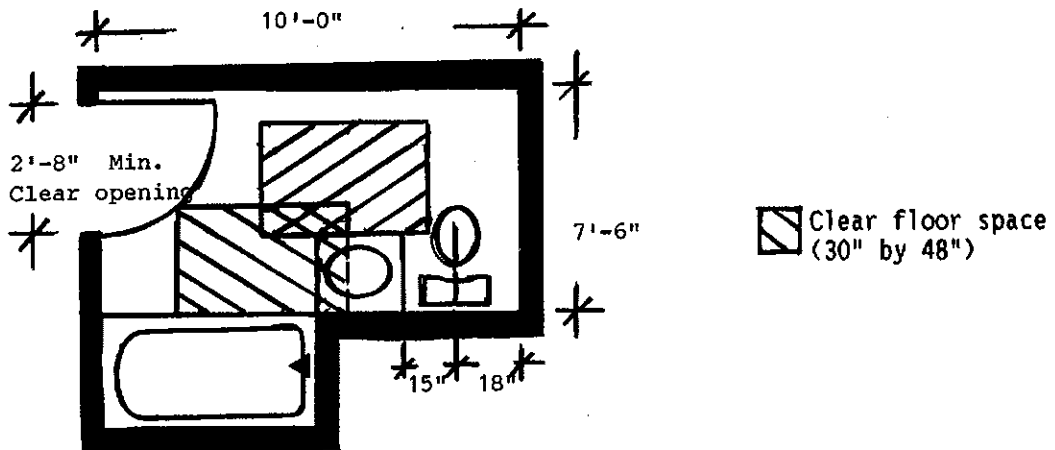


Clear Floor Space at Shower

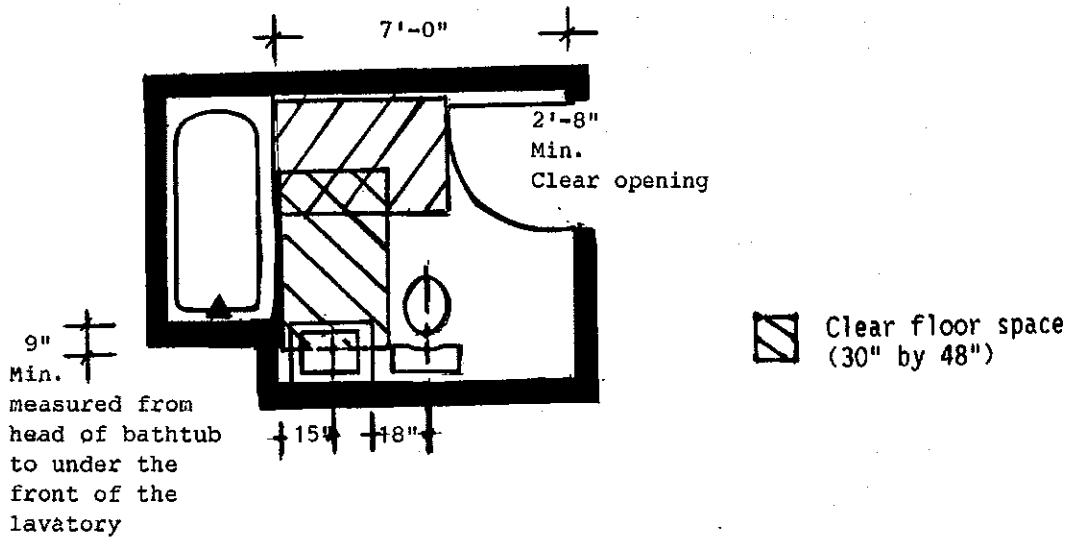
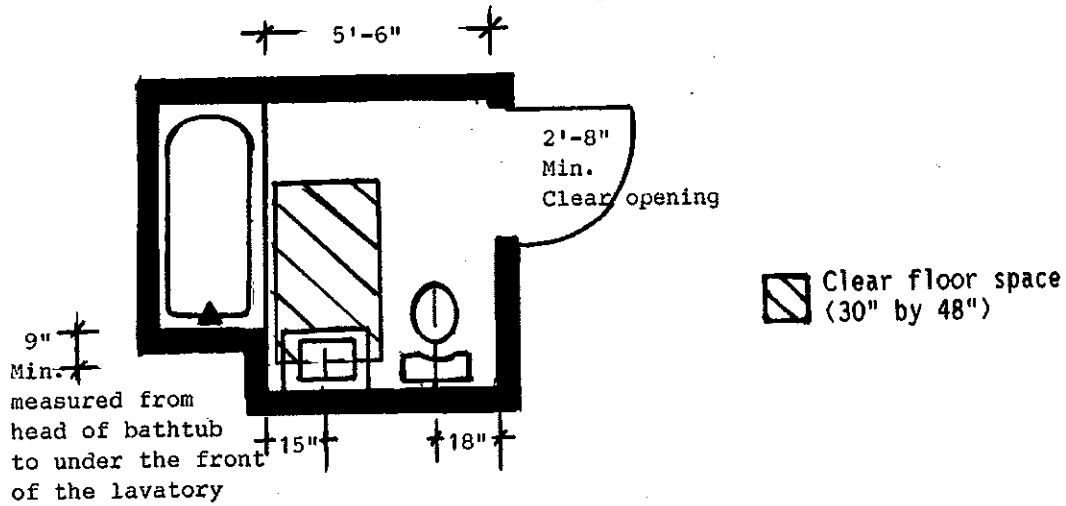
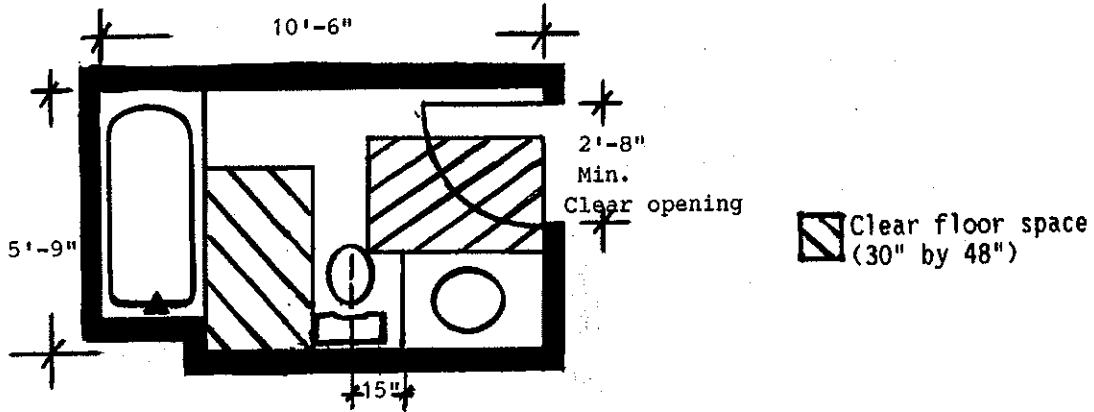
A-57.871 (1) BASIC USABILITY: EXAMPLE OF A COMPLETE BATHROOM COMPLYING WITH BASIC USABILITY.



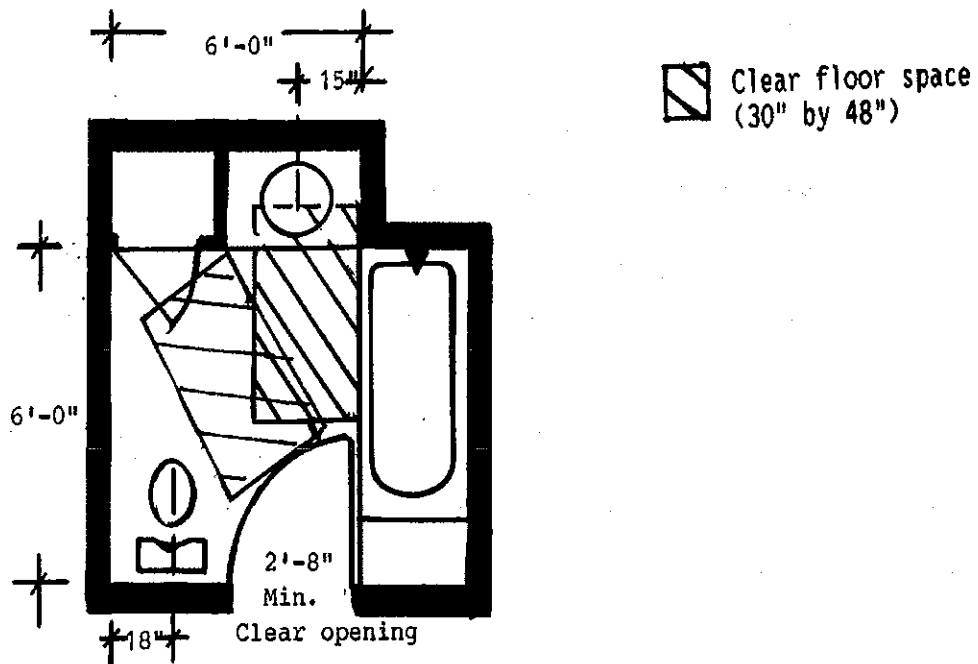
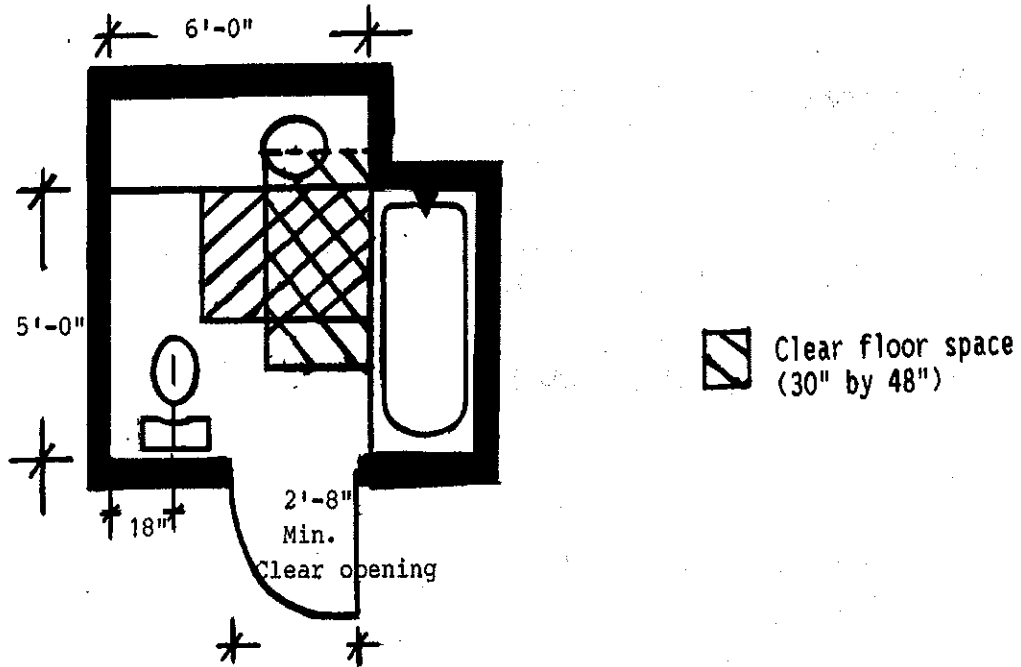
A-57.871 (2) HIGHER LEVEL OF USABILITY: EXAMPLES OF COMPLETE BATHROOMS COMPLYING WITH THE HIGHER LEVEL OF USABILITY.



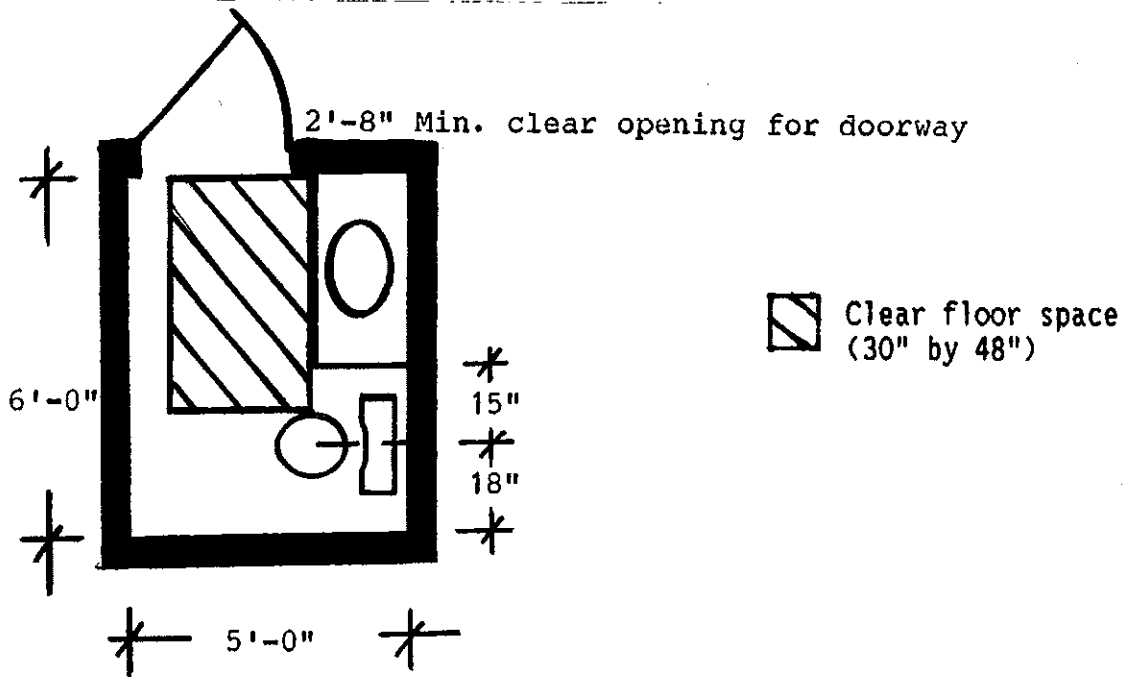
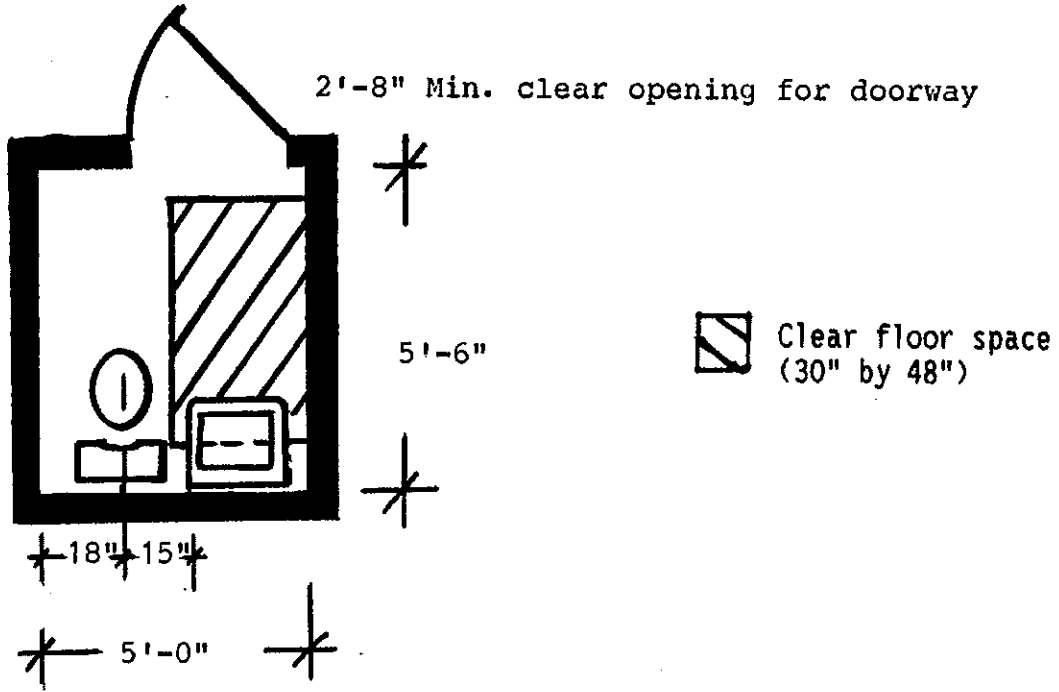
A-57.871 (2) HIGHER LEVEL OF USABILITY: EXAMPLES OF COMPLETE BATHROOMS COMPLYING WITH THE HIGHER LEVEL OF USABILITY.



A-57.871 (2) HIGHER LEVEL OF USABILITY: EXAMPLES OF COMPLETE BATHROOM COMPLYING WITH THE HIGHER DEGREE OF USABILITY.



A-57.871 (3) POWDER ROOMS: EXAMPLES OF ADAPTABLE POWDER ROOMS.



A-59.14 (2) (c) EXIT DISTANCE. See the information and illustration contained in A-54.02 (4).

A-60.19 (4) The standard is available from the National Fire Protection Association, Batterymarch Park, Quincy, Massachusetts 02269.

A-60.35 Class A fires are fires in ordinary combustibles such as wood, cloth, paper, rubber, and many plastics. Class B fires are fires in flammable liquids, gases and greases.

A-60.36 (1) (a) See A-60.19 (4).

A-62.25 (1) CLEARANCE LIMITATIONS. The intent is to require the minimum 7 feet 0 inches clearance only in traffic lanes and in all areas normally used by the public to leave from and return to their vehicles.

A-62.50 FIRE EXTINGUISHERS. See A-51.22 for related information.



CHAPTERS COMM 63 & 64 PLAN CHECK WORKSHEETS

SECTION I. ENERGY/HVAC FORM INDEX

SECTION II. BUILDING ENVELOPE

SECTION III. LIGHTING

SECTION IV. HVAC

The following worksheets, or equivalent information, is required to be submitted with each project. See Comm Ch. 63 and 64 for details.

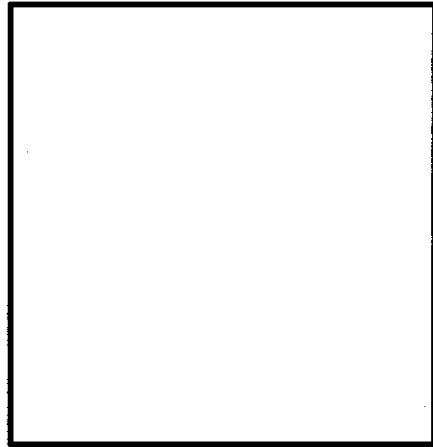
SBD-10373 (R.10/98)

INDEX **I-6**



Transaction ID#	Submitter's Name		
Owner's Name	Date		
Building Location (Number & Street)	City	Village	Township of

All constructions or installations under s. Comm 50.07 (2) and (3) shall be supervised by a Wisconsin registered architect or engineer, except that a Wisconsin registered HVAC designer may supervise the installation of heating, ventilating and air conditioning systems, and a registered electrical designer may supervise the installation of illumination systems. The plans, specifications, and calculations require the signature and seal or stamp of the appropriate professional listed above. Comm 50.08.



Registration Stamp & Signature

ENERGY EFFICIENCY PLAN CHECK WORKSHEETS

I. ENERGY/HVAC FORM INDEX

Check below if included with submittal

I-1: Index

II. BUILDING ENVELOPE PLAN CHECK WORKSHEETS

E-1: Building Envelope Summary

E-2: Fenestration Worksheet

E-3: Opaque Surfaces Worksheet

E-4: Skylight Exemption Worksheet

E-5: Opaque Trade-Off Worksheet

III. LIGHTING PLAN CHECK WORKSHEETS

L-1: Lighting Summary

L-2: Exterior Lighting Power Worksheet

L-3: Installed Interior Lighting Power Worksheet

L-4: Complete Building/Area Category Methods Worksheet

L-5: Activity Method Worksheet

IV. HVAC PLAN CHECK WORKSHEETS

H-1: HVAC Summary

H-2: HVAC Prescriptive Worksheet

H-3: HVAC Equipment Summary

The information you provide may be used by other agency programs [Privacy Law, s. 15.04 (1)(m)].

SBD-10512 (R.10/98)

II. BUILDING ENVELOPE PLAN CHECK DOCUMENTS

This section describes the forms and procedures for documenting compliance with the building envelope energy efficiency requirements of the code. It does not describe the details of the requirements; these are presented in the code. Determination of code compliance will be based on the actual code section. The following discussion is addressed to the designer preparing construction documents and compliance statements and to the plan reviewers who are examining those documents for compliance with the code.

The use of each form is briefly described below. The complete instructions for each form are presented in the following subsections.

E-1 Building Envelope Summary.

This information is required for every project involving the building envelope.

E-2 Fenestration Worksheet.

Used only for the Component Standards and System Standards methods. This worksheet produces area-weighted average values for the Fenestration U-Value and Shading Coefficient (SC_x). For the System Standards method of s. Comm 63.16, one of these worksheets should be completed for each orientation. (It is not necessary to fill this out if there is only one Fenestration U-Value and Shading Coefficient for the entire project.)

E-3 Opaque Surfaces Worksheet.

This worksheet is used only for the Component Standards method and System Standards method. This worksheet produces the area-weighted average values for the U-values of roof, walls (including opaque doors), and floor assemblies. For the System Standards method, one of these worksheets should be completed for each orientation.

E-4 Skylight Exemption Worksheet.

This information will only be required when skylights are to be exempt from the roof area thermal performance calculation.

E-5 Opaque Trade-Off Worksheet.

This information will only be required when opaque trade-offs are used per the requirements of Comm 63.15 (3) & (4).

SBD-10373 (R.10/98)

BUILDING ENVELOPE SUMMARY E-1

This worksheet is applicable to all projects involving the building envelope.

Project Information

This information asks for the project name and address and those people responsible for the building design and compliance forms.

Compliance Approach

Check one of the three boxes:

- Component Standards: If this box is checked, provide the number of the region in which the building is located from Figure 63.15-2 of the code and the Alternate Component Package (ACP) Table letter.
- System Standards: If this box is checked, provide the computer printout or other documentation of envelope compliance and E-1 form, or appropriate thermal performance calculations for factories and warehouses as listed in Comm 63.14 (2)(3).
- System Analysis Design: If the project is demonstrating compliance through the System Analysis Design method, check this box. A complete analysis must be provided.

Basic Requirements

Fill the boxes in this column with either a check mark or "X" to indicate a positive response or "N/A" to indicate a negative response. If the skylight exemption is marked (see "Special Considerations"), attach the Skylight Exemption Worksheet (E-4).

Prescriptive/Performance Requirements

If the project is demonstrating compliance through the Component Standards method, all of these items must be completed. The area-weighted properties such as components U-values and fenestration SC_x are obtained from the Fenestration Worksheet (E-2) and Opaque Surfaces Worksheet (E-3). The items under "Requirements" are obtained from the ACP Table.

If the System Standards method is used (e.g., ASHRAE's ENVSTD Program), only the items in the "Design" column need to be completed. Where there is more than one of a particular assembly, enter all of the values.

If the Opaque Trade-Off is used, provide the design information and demonstrate that the Total Design U•Area is equal to or less than the Total Required U•Area.

If the System Analysis Design method (e.g., ASHRAE's Energy Cost Budget method) is used, the items in the design column should be filled in, where applicable, to speed the plan review.

Additional Data

This column serves as a reference for additional building envelope forms and calculations. If Worksheets E-2 through E-5 are submitted, it should be indicated on Form I-1. Boxes are provided for other submittal data. An additional blank is provided to indicate attached calculations such as calculation of mass wall heat capacity or interpolations of tables.

FENESTRATION WORKSHEET E-2

This worksheet is applicable to projects that demonstrate compliance through the Component Standards method or the System Standards method. It is not applicable to projects that demonstrate compliance through the System Analysis Design method.

Project Information

A box for basic project information and identification of the document author is provided in the upper part of this form. This should match the information contained in the Basic Project Information section of the Building Envelope Summary (E-1) form.

Area-Weighted Properties

- Assembly ID:** Insert a descriptor of the particular assembly. A separate ID must be supplied for each group of assemblies that have unique U-values or shading coefficients.
- Area:** Enter the Total Area (in ft²) for that fenestration assembly (glazing and frame) on a project-wide basis. For the System Standards method, this would be the area for that assembly on an orientation basis. The values from all entries in this column should be summed into the box marked "Total Area" at the bottom of the column.
- U-Value (or shading coefficient, SC_x):** Enter the appropriate property for each fenestration assembly (glazing and frame).
- U (or SC_x) • Area:** This column is the product of the assembly area (second column) by the fenestration U-value (or SC_x from the third column). The values from all entries in this column should be summed into the box marked "Total U•Area" at the bottom of the column.
- The area-weighted U-value (or SC_x) is calculated by dividing the value in "Total U•Area" by the value in "Total Area."

OPAQUE SURFACES WORKSHEET E-3

This worksheet is applicable to projects that demonstrate compliance through either the Component Standards method or System Standards method. It is not applicable to projects that demonstrate compliance through the System Analysis Design method.

Project Information

A box for basic project information and identification of the document author is provided in the upper part of this form. This should match the information contained in the Basic Project Information section of the Building Envelope Summary (E-1) form.

- Assembly ID:** Insert a descriptor of the particular assembly. This may be a descriptor or number from the appropriate schedule in the plans. A separate item must be supplied for each group of assemblies that have unique U-values.
- Area:** Enter the Total area (in ft²) for that assembly (roof, wall, or floor) on a project-wide basis. For the System Standards method, this would be the area for that assembly on an orientation basis. The values from all entries in this column should be summed into the box marked "Total Area" at the bottom of the column.
- U-Value:** Enter the appropriate property for each assembly. Overall thermal transmittance of assemblies must be calculated in accordance with s. Comm 63.18. The calculation procedure must consider the effect of framing.
- If skylights are installed, they must be included in the overall U-value calculation of the roof unless an exemption is obtained under s. Comm 63.12. A skylight exemption worksheet (E-4) must be included.
- U•Area:** This column is the product of the assembly area (second column) by the assembly U-value. The values from all entries in this column should be summed into the box marked "Total U•Area" by the value in "Total Area."
- The area-weighted U-value is calculated by dividing the value in "Total U•Area" by the value in "Total Area."

SKYLIGHT EXEMPTION WORKSHEET E-4

This worksheet is applicable when skylights are exempt from the roof area overall U-value calculation per the requirements of Comm 63.12. It may be used with any method of compliance.

Project Information

A box for basic project information and identification of the document author is provided in the upper part of this form. This should match the information contained in the Basic Project Information section of the Building Envelope Summary (E-1) form.

Skylight Exemption Worksheet

All of the boxes except the item marked "Special Consideration" (50% shading device credit) must be filled in with a check or "X" to indicate affirmation. The 50% shading device credit box must be filled in with either a check, "X," or "N/A."

All of the "Design" and "Requirement" information must be completed. The skylight-to-roof ratio requirement is the maximum percent of skylight area taken from ASHRAE 90.1, Tables 8-3a and 8-3b of Table A63.12. The maximum area will depend on the visible light transmittance (VLT) and whether or not shading is provided for the skylight.

The lighting power density may be taken from the allowed lighting power density from s. Comm 63.47, 63.48, or 63.49, or the actual installed lighting power density adjusted for controls under s. Comm 63.45 (2) may be used.

The design lighting level, in foot-candles, is the judgment of the designer, but should be in general agreement with the recommendations of the Illuminating Engineering Society. (Refer to the IES Lighting Handbook, application volume, 1987.) The designer should choose the lighting level in the table closest to the condition in the proposed building. Interpolation or extrapolation for lighting level is not permitted.

OPAQUE TRADE-OFF WORKSHEET E-5

This worksheet is applicable to projects that demonstrate compliance through Opaque Trade-Offs as used with the requirements of Comm 63.15 (3) & (4).

Project Information

A box for basic project information and identification of the document author is provided in the upper part of this form. This should match the information contained in the Basic Project Information section of the Building Envelope Summary (E-1) form.

- Assembly ID:** Insert a descriptor of the particular assembly. This may be a descriptor or number from the appropriate schedule in the plans. A separate item must be supplied for each group of assemblies that have unique U-values.
- Area:** Enter the Total area (in ft²) for that assembly (roof, wall, or floor) on a project-wide basis. For the System Standards method, this would be the area for that assembly on an orientation basis. The values from all entries in this column should be summed into the box marked "Total Area" at the bottom of the column.
- U-Value:** Enter the appropriate property for each assembly. Overall thermal transmittance of assemblies must be calculated in accordance with s. Comm 63.18. The calculation procedure must consider the effect of framing.
If skylights are installed, they must be included in the overall U-value calculation of the roof unless an exemption is obtained under s. Comm 63.12. A skylight exemption worksheet (E-4) must be included.
- U•Area:** This column is the product of the assembly area (second column) by the assembly U-value.
- Total Design U•Area:** Add all U•Area values associated with the Design column. The U•Area values are to be derived from the designed roofs, walls adjacent to unconditioned spaces, above grade exterior walls, and floors over unconditioned spaces.
- Total Required U•Area:** Add all U•Area values associated with the Requirement column. The U•Area values are to be derived from code required roofs, walls adjacent to unconditioned spaces, above grade exterior walls, and floors over unconditioned spaces.
- Compliance is shown when the "Total Design U•Area" is less than or equal to the "Total Required U•Area."

BUILDING ENVELOPE SUMMARY

E-1



Transaction ID#	Submitter's Name
Owner's Name	Date
Building Location (Number & Street)	City Village Township of

Compliance Approach **Component Standards** **System Standards** **System Analysis Design**
 (See Comm 63.15) (See Comm 63.16) (See Comm 63.70-72)
 Region ACP Table (See Fig. 63.15-2)

Basic Requirements		Prescriptive/Performance Requirements			Additional Data	
<input type="checkbox"/>	U-values reported on this form are area-weighted averages. Comm 63.18 (1)	Fenestration Properties	Design	Requirement		Fenestration Worksheet (E-2)
<input type="checkbox"/>	Windows and doors meet the air infiltration requirements. Comm 63.11	Window Area (WA) Comm 63.05 (79)	_____	If using Component Standards, see ACP Table Fig. 63.15-2		Opaque Surfaces Worksheet (E-3)
<input type="checkbox"/>	Fenestration U-values are certified by NFRC or from Table 63.18-3. Comm 63.18 (2) (b)	Gross Wall Area (GWA) Comm 63.05 (27) Comm 63.18 (2) (b) & (3)	_____			
<input type="checkbox"/>	Fenestration shading coefficients are obtained from either the 1989 ASHRAE Handbook of Fundamentals or manufacturer's data. Comm 63.18 (4)	Window-Wall Ratio (WA/GWA) Comm 63.05 (80)	_____	≤ _____		Skylight Exemption Worksheet (E-4)
<input type="checkbox"/>	Exterior joints, cracks, and holes in the building envelope are caulked, gasketed, weather stripped, or otherwise sealed. Comm 63.11	Window U-value Comm 63.18 (2) (b) Window SCx Comm 63.18 (4)	_____		<input type="checkbox"/>	Opaque Trade-off Worksheet (E-5) Marked Up ACP Table Included
<input type="checkbox"/>	Double entry vestibule? (Optional—check if provided)	Skylights Installed	_____ Yes	_____ No		
<input type="checkbox"/>	U-values reported on this form are area-weighted averages. Comm 63.18 (1)	Wall Design			<input type="checkbox"/>	COMcheck-EZ Report Included
<input type="checkbox"/>	An approved method which accounts for the thermal bridging of framing is used to calculate U-values for envelope assemblies. Comm 63.18 (2)	U-value Comm 63.18 (2) (a) Heat Capacity (HC) Comm 63.05 (34) Appendix A63.15 (3) (b)	_____		<input type="checkbox"/>	ENVSTD Output Included
<input type="checkbox"/>	Exterior joints, cracks, and holes in the building envelope are caulked, gasketed, weather stripped, or otherwise sealed. Comm 63.11	Insulation position (interior or exterior) Comm 63.05 (44)	_____			
<input type="checkbox"/>	Vapor barriers are installed to prevent deterioration of insulation performance. Comm 63.11 (4)	U-Values Roof Comm 63.18 (2) (a)	_____	≤ _____		
<input type="checkbox"/>	Special Consideration The skylight exemption is applied. Comm 63.12	Walls adjacent to unconditioned space Comm 63.18 (2) (a)	_____	≤ _____		
	(Attach Skylight Exemption Worksheet E-4)	Floors over unconditioned space Comm 63.18 (2) (a)	_____	≤ _____		
<input type="checkbox"/>	R-values reported on this form for slab-on-grade floors and walls before grade include only the insulating material. Comm 63.15 (5) and (6)	R-Values Walls below grade Comm 63.18 (2) (a)	_____	≥ _____		
<input type="checkbox"/>	Insulation continuity is maintained. Comm 63.15 (5)	Slab-on-grade Comm 63.18 (2) (a)	_____	≥ _____		

BUILDING ENVELOPE SUMMARY **E-2**



Transaction ID#	Submitter's Name
Owner's Name	Date
Building Location (Number & Street)	City Village Township of

Fenestration Orientation:
For System Standards Method

Area-Weighted Properties – Comm 63.18

Fenestration U-Value (U_{of}) see Comm 63.18 (2) (b)

Assembly ID	Area	U-Value	U•Area
		×	=
		×	=
		×	=
		×	=
		×	=
		×	=
		×	=
		×	=
Total Area →		Total U•Area →	

$$\frac{\text{Total U} \cdot \text{Area}}{\text{Total Area}} = \boxed{}$$

Fenestration Shading Coefficient (SC_x) see Comm 63.18 (4)

Assembly ID	Area	SC_x	$SC_x \cdot \text{Area}$
		×	=
		×	=
		×	=
		×	=
		×	=
		×	=
		×	=
		×	=
Total Area →		Total $SC_x \cdot \text{Area}$ →	

$$\frac{\text{Total } SC_x \cdot \text{Area}}{\text{Total Area}} = \boxed{}$$

OPAQUE SURFACES WORKSHEET

E-3



Transaction ID#	Submitter's Name
Owner's Name	Date
Building Location (Number & Street)	City Village Township of

Fenestration Orientation:

For System Standards Method

Area-Weighted Properties – Comm 63.18

Roofs see Comm 63.18 (2) (a)

Assembly ID	Area	U-Value	U•Area
		X	=
		X	=
		X	=
		X	=
Total Area →		Total U•Area →	

$$\frac{\text{Total U•Area}}{\text{Total Area}} = \boxed{}$$

Walls Adjacent to Unconditioned Spaces see Comm 63.18 (2) (a)

Assembly ID	Area	U-Value	U•Area
		X	=
		X	=
		X	=
		X	=
Total Area →		Total U•Area →	

$$\frac{\text{Total U•Area}}{\text{Total Area}} = \boxed{}$$

Above Grade Exterior Walls see Comm 63.18 (2) (a)

Assembly ID	Area	U-Value	U•Area
		X	=
		X	=
		X	=
		X	=
Total Area →		Total U•Area →	

$$\frac{\text{Total U•Area}}{\text{Total Area}} = \boxed{}$$

Floors Over Unconditioned Spaces see Comm 63.18 (2) (a)

Assembly ID	Area	U-Value	U•Area
		X	=
		X	=
		X	=
		X	=
Total Area →		Total U•Area →	

$$\frac{\text{Total U•Area}}{\text{Total Area}} = \boxed{}$$

SKYLIGHT EXEMPTION WORKSHEET

E-4



Transaction ID #	Submitter's Name		
Owner's Name	Date		
Building Location (Number & Street)	City	Village	Township of

Skylight Exemption Requirements see Comm 63.12		Additional Data	
<input type="checkbox"/> U-values of skylight curbs are less than 0.21 Btu/hr•ft ² •°F.	Skylight Design Data	Design	Requirement
<input type="checkbox"/> Overall thermal transmittance of skylight assemblies is less than 0.70 Btu/hr•ft ² •°F.	Skylight Area (SA)	_____	
	Gross Roof Area (GRA)	_____	
	Skylight-to-Roof Ratio (SA/GRA)	_____	≤ _____
<input type="checkbox"/> Air leakage is less than 0.5 cfm/ft ² of skylight.			
<input type="checkbox"/> Automatic daylighting controls installed to reduce electric lighting by 50%.	Skylight U-value	_____	
	Skylight VLT	_____	
Special Consideration	Lighting Power Density (LPD/ft ²)	_____	
<input type="checkbox"/> Shading devices used to block 50% of the solar gain during peak cooling conditions.	Design lighting level (footcandles)	_____	
			<input type="checkbox"/> ENVSTD output
			<input type="checkbox"/> Calculation of allowed skylight percent.
			<input type="checkbox"/> Sketch of shading devices.

OPAQUE ASSEMBLY TRADE-OFF WORKSHEET

E-5



Transaction ID#	Submitter's Name
Owner's Name	Date
Building Location (Number & Street)	City Village Township of

DESIGN

Design – Roofs see Comm 63.18 (2) (a)

Assembly ID	Area	U-Value	U•Area
	X		=
	X		=
	X		=
	X		=
Total Area →			

Design – Above Grade Exterior Walls
see Comm 63.18 (2) (a)

Assembly ID	Area	U-Value	U•Area
	X		=
	X		=
	X		=
	X		=

Design – Walls Adjacent to Unconditioned Space
see Comm 63.18 (2) (a)

Assembly ID	Area	U-Value	U•Area
	X		=
	X		=
	X		=
	X		=
Total Area →			

Design – Floors Over Unconditioned Space
see Comm 63.18 (2) (a)

Assembly ID	Area	U-Value	U•Area
	X		=
	X		=
	X		=
	X		=
Total Area →			

REQUIREMENT

Required – Roofs see Comm 63.15 (4)

Total Area	Required U-Value	U• Area
X		=

Required – Above Grade Exterior Walls
See Comm 63.15 (4)

Total Area	Required U-Value	U• Area
X		=

Required – Walls Adjacent to Unconditioned Space
See Comm 63.15 (4)

Total Area	Required U-Value	U• Area
X		=

Required – Floors Over Unconditioned Space
See Comm 63.15 (4)

Total Area	Required U-Value	U• Area
X		=

III. LIGHTING PLAN CHECK DOCUMENTS

This section describes the forms and procedures for documenting compliance with the lighting energy efficiency requirements of the code. It does not describe the details of the requirements; these are presented in the code. The following discussion is addressed to the designer preparing construction documents and compliance statements and to the plan reviewers who are examining those documents for compliance with the code.

The use of each form is briefly described below. The complete instructions for each form are presented in the following subsections.

L-1: Lighting Summary.

This information is required for every project involving lighting and lighting controls.

L-2: Exterior Lighting Power Worksheet.

This information is also required for every project involving lighting and lighting controls.

L-3: Installed Interior Lighting Power Worksheet.

This information is also required for every project involving lighting and lighting controls.

L-4: Complete Building/Area Category Methods Worksheet

This information will only be required when calculating the Interior Lighting Power Allowance using either the Complete Building Method or the Area Category Method.

L-5: Activity Method Worksheet.

This information will only be required when calculating the Interior Lighting Power Allowance using the activity method.

SBD-10377 (R.10/98)

LIGHTING SUMMARY L-1

The Lighting Summary (L-1) form is in four parts. A copy of these forms must be submitted to the Division along with the rest of the compliance submittal at the time of building plan review.

A. Lighting Summary (L-1) Part 1

Project Information

Part 1 of the Lighting Summary form asks for the project name and address and those people responsible for the lighting design and compliance forms. The project name and address should be the same as on the Building Envelope forms for the project.

Method of Interior Lighting Compliance

Check one of the four boxes:

- | | |
|--------------------|--|
| Complete Building: | If this box is checked, the Complete Building/Area Category Methods Worksheet (L-4) must be provided. |
| Area Category: | If this box is checked, the Complete Building/Area Category Methods Worksheet (L-4) must be provided. |
| Activity: | If this box is checked, the Activity Method Worksheet (L-5) must be provided. |
| Other: | If compliance for the project is demonstrated through the System Analysis Design method of ss. Comm 63.70-72 where all energy-using systems are considered together, check this box. A complete analysis must be provided. |

Basic Requirements

All of the boxes in this column must be filled with either a check or "X" to indicate affirmation or "N/A" to indicate not applicable. For exterior lighting, enter the Exterior Lighting Power (ELP) and the Exterior Lighting Power Allowance (ELPA). These are obtained from the Exterior Lighting Power Worksheet (L-2).

Prescriptive/Performance Requirements

Enter the Installed Interior Lighting Power (ILP) and the Interior Lighting Power Allowance (ILPA). The ILP is obtained from the Interior Lighting Power Allowance Worksheet (L-3). The ILPA is obtained from the Complete Building/Area Category Methods Worksheet (L-4) if either the Complete Building Method or the Area Category Method is used. The ILPA is obtained from the Activity Method Worksheet (L-5) if the if the Activity Method is used. The lighting power control credits box is filled with a check or "X" when control credits are taken, otherwise enter "N/A."

Worksheets

Indicate which worksheets are attached.

B. Lighting Summary (L-1) Parts 2 to 4

Parts 2 to 4 of the Lighting Summary should be used to describe the installed lighting schedule, and the control devices associated with the building design. If necessary, make extra copies of the forms. The information on the L-1 parts 2 to 4 forms may be incorporated into equipment schedules on the plans along with light fixture information, rather than presented on the forms. If this is done, however, the same information should be included in one schedule and in a similar format as the forms.

Lighting Summary (L-1) Part 2

Luminaire Name: Record the description by name or type.

- Lamp Type:** Record the type of lamp (Incandescent, Fluorescent or High-Intensity discharge).
- Watts/Lamp:** Record the listed watts per lamp. For track and incandescent medium base socket fixture, see s. Comm 63.45 (4) for how to determine the watts of these types of luminaires. If track lighting is used and the fixtures are not shown on the Installed Lighting Schedule, 45 watts per foot of track is entered in this column.
- Ballasts Type:** Record the ballast type — Standard Energy-Saving Magnetic (S), Electronic High Frequency* (E) or Other* (O). If Electronic High Frequency or Other ballast types are used, the exact ballast type and model number should be specified.
- Number/Luminaire:** Record the number of ballasts installed in each Luminaire.

Mandatory Controls (L-1) Part 3

The Mandatory Controls portion is where those devices to meet the mandatory control requirements are listed. This would include devices for building shut-off, individual room control, and control of exterior lights. If some mandatory controls meet the requirements of s. Comm 63.45 (2), the information should also be recorded on Part 4, Automatic Controls for Credit, if control credits are taken in the ILP calculation.

- Control Location:** Record the location of the control on the plans.
- Control Identification:** Record the symbol of the control on the plans.
- Control Type:** Record the type of certified control device used to meet the mandatory automatic control requirement.
- Space Controlled:** Record the location of controlled lights.
Typical controls may be covered by general notation.

Automatic Controls for Credit (L-1) Part 4

The Automatic Controls for Credit portion is similar to the Mandatory Controls portion. The only difference is the last column.

- Luminaires Controlled:** Record the luminaire type and quantity controlled for credit.
- Type:** Record the same name as on the plans.
- Number of Luminaires:** Record the number of luminaires of that type that are controlled by the control type.
Typical controls may be covered by general notation.

Reviewer Notes

This space is used by the Department Plan Examiner during review of the submitted information.

EXTERIOR LIGHTING POWER WORKSHEET L-2

This worksheet is applicable to all projects.

Project Information

A box for basic project information and identification of the document author is provided in the upper part of this form. This should match the information contained in the Project Information section of the Lighting Summary (L-1) form.

Exterior Lighting Power Allowance — ELPA

- Area Description:** This is a descriptor of each line. These descriptors match those in Comm Table 63.43.
- Allowance:** This is the allowance in either W/ft^2 or watts of lineal feet. These allowances match those in Comm Table 63.43.
- Area or Lineal Feet in Proposed Design:** Record the area (ft^2) or lineal footage (lf) as appropriate. These values should be project-wide values.
- ELPA:** Multiply the allowance from Column B by the area (or lineal footage) from Column C. Record the resultant ELPA in Column D. The values should be summed into the box marked "Total ELPA" at the bottom of the column.

Installed Exterior Lighting Power

Do not include luminaires that are exempted under s. Comm 63.42.

- Fixture Type:** Record the description of the luminaires that are included.
- Number of Luminaires:** Record the total number of similar luminaires in the project.
- Watts per Luminaire:** Record the input wattage for each luminaire, including the ballast.
- Installed Wattage:** Multiply the number of luminaires from Column B by the wattage per luminaire from Column C. Enter the resultant installed wattage in Column D. The values from all entries in the column should be summed into the box marked "Total ELP" at the bottom of the column.

INSTALLED INTERIOR LIGHTING POWER WORKSHEET L-3

The Installed Interior Lighting Power Worksheet (L-3) will be completed and submitted with all applications. Either the Complete Building/Area Category Method Worksheet (L-4), the Activity Method Worksheet (L-5), or System Analysis Design documentation will be included with L-3, depending on the ILPA calculation method chosen.

Project Information

A box for basic project information and identification of the document author is provided in the upper part of this form. This should match the information contained in the Project Information section of the Lighting Summary (L-1) form.

Installed Interior Lighting Power

The calculated interior lighting power to be installed is determined by completing this form. *Do not include luminaires that are exempted under s. Comm 63.45.* If necessary, make extra copies of this form. Use as many sheets as needed for the project.

Luminaire Name or ID No.: Record the name or symbol. It should be consistent with what is used in the lighting schedule.

Description: Record a short list of the technical features (i.e., luminaire size and type, lamp type and number, ballast type, lens/louver type).

Number of Luminaires: Record the quantity of each fixture type in the building. If track lighting is used and the fixtures are not shown on the plans, the length of the track is entered in this column.

(Tip: If control credits are to be used and all of any type of luminaires are not controlled or used with the same control, split the luminaries up over several lines, one for each control type.)

Watts per Luminaire: Record the total wattage of each luminaire type (including ballasts for fluorescent or high intensity discharge fixtures). For track and incandescent medium base socket fixtures, see s. Comm 63.45 (4) for how to determine the watts of these types of luminaires. If track lighting is used and the fixtures are not shown on the Installed Lighting Schedule, 45 watts per foot of track is entered in this column. The wattage may be a standard value from the data in Table A63.45. Nonstandard values not from Table A63.45 must be substantiated with manufacturer's data sheets.

Total Watts: Record the product of the quantity of each luminaire listed times its watts per luminaire. If credit for automatic lighting controls is not sought, the interior lighting power is the sum of this Column E.

LPAF for Automatic Controls: If lighting power control credits are used, enter the appropriate lighting power adjustment factor from Table 63.45. If this credit is not used, leave Columns F, G, and H blank.

Control Credit: Multiply the total watts of luminaires associated with the control of Column E by the LPAF of Column F. Record the resultant control credit in Column G.

Adjusted Watts: Subtract the control credit of Column G from the total watts of Column E. Record the remainder in Column H.

The sum of Column E (or Column H if control credits are used) is the calculated interior lighting power for the building. If more than one sheet is used, enter the total for all sheets. This total cannot be greater than the Interior Lighting Power Allowance calculated on worksheet L-4 or L-5.

COMPLETE BUILDING/AREA CATEGORY METHODS WORKSHEET L-4

This worksheet will be attached to L-3 whenever the Complete Building Method or the Area Category Method is used to calculate the Interior Lighting Power Allowance.

Project Information

A box for basic project information and identification of the document author is provided in the upper part of this form. This should match the information contained in the Project Information section of the Lighting Summary (L-1) form.

Interior Lighting Power Allowance

The Interior Lighting Power Allowance (ILPA) is determined by calculating the maximum total watts of lighting that may be installed. As noted on the Lighting Summary, L-1, there are four different methods that may be used. These methods may not be mixed in the same building permit application. This form is used when the ILPA is calculated by the Complete Building or Area Category Method.

Complete Building Method

This method may only be used when plans and specifications for the entire building are included in the application.

Building Type of Use:	This is taken from Table 63.47 for the type of use of the building. If the building has a mixture of uses, the major use must be at least 80 percent of the conditioned floor area. If there is no major use, this method may not be used.
Watts per Square Foot:	Record the allowed lighting power density in watts per square foot for this building type taken from Comm Table 63.47.
Complete Building Area:	Record the conditioned floor area of the entire building, including the conditioned floor area of minor occupancies. See 63.05 (6) for the definition of conditioned floor area.
Allowed Watts:	Record the product of the watts per square foot times the complete building area. This becomes the Interior Lighting Power Allowance for the building.

Area Category Method

This method may be used when different primary function areas of a building are included in the application.

Primary Function:	This is taken from Comm Table 63.48 for the primary function of the area. If the building has a mixture of functions, each function area must be listed separately.
Watts per Square Foot:	Record the allowed lighting power density watts per square foot for this building type taken from Comm Table 63.48.
Area:	Record the conditioned floor area (in square feet) of the primary function area measured from the inside of partitions.
Allowed Watts:	Record the product of the watts per square foot times the primary function area. This becomes the allowed lighting power for the area.

The sum of the allowed lighting power for each primary function area is the Interior Lighting Power Allowance for the building.

ACTIVITY METHOD WORKSHEET L-5

This worksheet is applicable to all projects including those that use the Activity Method of s. Comm 63.49. If necessary, make extra copies of this form. Use as many sheets as needed for the project.

Project Information

A box for basic project information and identification of the document author is provided in the upper part of this form. This should match the information contained in the Project Information section of the Lighting Summary (L-1) form.

Interior Lighting Power Allowance — ILPA

- Column A: Record the room number or room name. A range of similar rooms may also be entered.
- Column B: Record the average ceiling height of the room in feet.
- Column C: Record a description of each line item. The description shall match the appropriate description from Table 63.49.
- Column D: Record any notes from Table 63.49. These notes may limit the Area Factor used in Activity Method calculations.
- Column E: Record the appropriate unit lighting power density (UPD) from Table 63.49.
- Column F: Record the floor area of the room (inside wall to inside wall, ft²). Where multiple rooms are included in single line, this is the average area of each type of room and not the total area of all rooms.
- Column G: Record the area factor from either s. Comm 63.49, Figure 63.49, or an applicable footnote from Table 63.49.
- Column H: Record the number of similar spaces.
- Column I: Multiply the UPD from Column E by the floor Column F by the area factor from Column G by the number of similar rooms from Column H. Record the resultant lighting power budget in Column I. The values from all entries in this column should be summed into the box marked "ILPA" at the bottom of the column.

LIGHTING SUMMARY

L-1 - Part 1 of 4



Transaction ID #	Submitter's Name		
Owner's Name	Date		
Building Location (Number & Street)	City	Village	Township of

Method of Interior Lighting Compliance (check one)

- Complete Building s. Comm 63.47
- Area Category s. Comm 63.48
- Activity s. Comm 63.49
- Other s. Comm 63.70-72

Basic Requirements	Prescriptive/Performance	Additional Data
<input type="checkbox"/> Exterior lighting not intended for 24-hour use controlled by photocell. Comm 63.50	$\frac{\text{Installed ELP}}{\text{ELPA}} \leq \text{Comm 63.43}$	Exterior Lighting Power Worksheet (L-2)
<input type="checkbox"/> Shut-off control in each space enclosed by ceiling-high partitions. Comm 63.50 (1) <input type="checkbox"/> Controls to reduce lighting by 50%. Comm 63.50 (2) <input type="checkbox"/> Controls to reduce lighting in daylit areas. Comm 63.50 (3) <input type="checkbox"/> Automatic shut-off controls. Comm 63.50 (4) <input type="checkbox"/> Display lighting separately switched on circuits ≤ 20 amps. Comm 63.50 (5) <input type="checkbox"/> Hotel/motel guest rooms have master switches at the main door to turn off lights and receptacles. Comm 63.50 (7)		
<input type="checkbox"/> Exit signs have installed wattage of 20 watts or less. Comm 63.52 <input type="checkbox"/> Fluorescent lamps use multiple lamp ballasts with tandem wiring as required. Comm 63.53	$\frac{\text{ILP}}{\text{ILPA}} \leq \text{Comm 63.47, 63.48, or 63.49}$ <input type="checkbox"/> Lighting Power Control Credits Applied. Comm 63.45 <ul style="list-style-type: none"> <input type="checkbox"/> Daylight Sensing Controls <input type="checkbox"/> Occupancy Sensors <input type="checkbox"/> Programmable Timing Controls <input type="checkbox"/> Lumen Maintenance Controls 	Interior Lighting Power Worksheet (L-3) Interior Lighting Power Allowance Worksheet (L-4) Activity Method Worksheet (L-5)

The information you provide may be used by other agency programs [Privacy Law, s. 15.04 (1)(m)].

SBD-10377 (R.10/98)

LIGHTING SUMMARY

L-1 - Part 3 of 4



Transaction ID #	Submitter's Name		
Owner's Name	Date		
Building Location (Number & Street)	City	Village	Township of

MANDATORY CONTROLS (s. Comm 63.50)

(Optional if included on plans - Use as many sheets as necessary)

Control Location (Room #)	Control Identification	Control Type (Occupancy Sens., Daylight, etc.)	Space Controlled	Note to Field

REVIEWER NOTES - For Department Use Only

EXTERIOR LIGHTING POWER WORKSHEET **L-2**



Transaction ID #	Submitter's Name
Owner's Name	Date
Building Location (Number & Street)	City Village Township of

EXTERIOR LIGHTING POWER ALLOWANCE - ELPA (s. Comm 63.43)

A Area Description	B Allowance (Table 63.43)	C Area or Lineal Feet in Proposed Design	D ELPA (B•C)
Exit (with or without canopy)	25 W/lf of door opening		
Entrance (without canopy)	30 W/lf of door opening		
High Traffic Entrance (with canopy)	10 W/ft ² of canopied area		
Light Traffic Entrance (with canopy)	4 W/ft ² of canopied area		
Loading Area	0.40 W/ft ²		
Loading Door	20 W/lf of door opening		
Building Exterior Surfaces or Storage and Nonmanufacturing	0.25 W/ft ² of illuminated		
Casual Use Areas (gardens, etc.)	0.20 W/ft ²		
Private Driveways or Walkways	0.10 W/ft ²		
Public Driveways or Walkways	0.15 W/ft ²		
Private Parking Lots	0.12 W/ft ²		
Public Parking Lots	0.18 W/ft ²		
Total ELPA			

INSTALLED EXTERIOR LIGHTING POWER - ELP (s. Comm 63.42)

A Fixture Type	B Number of Luminaires Installed	C Watts per Luminaire (including ballast)	D Installed Watts (B•C)
Total Installed ELP			

INSTALLED INTERIOR LIGHTING POWER WORKSHEET L-3



Transaction ID #	Submitter's Name		
Owner's Name	Date		
Building Location (Number & Street)	City	Village	Township of

INSTALLED INTERIOR LIGHTING POWER (s. Comm 63.45)

(Use as many sheets as necessary)

A	B	C	D	E	F	G	H
Luminaire Name or ID No.	Luminaire Description	Number of Luminaires	Watts per Luminaire (including ballast)	Total Watts (C•D)	LPAF for Automatic Controls (Table 63.45)	Control Credit (E•F)*	Adjusted Watts (E•G)
Total for this Sheet Total for all Sheets (if control credits not taken)					Total for this Sheet Total for all Sheets (Adjusted with control credits)		

*Note: If control credits are taken, Form L-1, Part 3 must be completed or controls must be indicated on the plans.

COMPLETE BUILDING/AREA CATEGORY METHOD WORKSHEET L-4



Transaction ID #	Submitter's Name		
Owner's Name	Date		
Building Location (Number & Street)	City	Village	Township of

INTERIOR LIGHTING POWER ALLOWANCE (ILPA) (s.Comm 63.47 or 63.48)
 (Choose *one* method or use the Activity Method and Form L-5)

Complete Building Method

Building Type of Use From Table 63.47	Watts/ft ²	Complete Bldg. Area	Allowed Watts

Area Category Method

Primary Function From Table 63.48	Watts/ft ²	Area (ft sq.)	Allowed Watts
Totals			

ft² Area Watts

IV. HVAC SYSTEMS PLAN CHECK DOCUMENTS

This section describes the forms and procedures for documenting compliance of Heating, Ventilation and Air Conditioning (HVAC) systems with the energy efficiency requirements of the code. It does not describe the details of the requirements; these are presented in the code. Determination of compliance will be based on the actual code section. The following discussion is addressed to the designer preparing construction documents and compliance statements, and to the plan reviewers who examine those documents for compliance with the code.

Note: These forms cannot be used to demonstrate compliance with the Ch. Comm 64 ventilation requirements. That information must be provided separately.

The use of each form is briefly described below. The complete instructions for each form are presented in the following subsections.

H-1: HVAC Systems Summary.

This information is required for every project involving heating, ventilation and air conditioning equipment & systems.

H-2: HVAC Prescriptive Worksheet.

This information is applicable to projects that demonstrate compliance through a prescriptive means by following the requirements of Subchapter IV. It is not applicable to projects that demonstrate compliance through the System Analysis Design method of ss. Comm 63.70-72.

H-3: HVAC Equipment Summary.

This information is required for every project.

SBD-10375 (R.10/98)

HVAC SYSTEMS SUMMARY H-1

This worksheet is applicable to all projects

Project Information

This information asks for the project name and address and those people responsible for the HVAC design and compliance forms. The project name and address must match the information given on the building envelope forms. Check the box as indicated if the System Analysis Design method will be used to show compliance.

Basic Requirements Check List

All of the boxes in this column must be filled with either a check or "X" to indicate affirmation or "N/A" to indicate that the item or issue is not applicable.

Worksheet

If using the System Analysis Design method, the HVAC Prescriptive worksheet (H-2) does not need to be completed. Fill in the box with a check or "X" if it is included.

Special Considerations

Fill in these boxes with a check or "X" where applicable.

HVAC PRESCRIPTIVE WORKSHEET H-2

This worksheet provides detailed information on zone controls and economizer controls. It is not required if the System Analysis Design method is used.

Project Information

A box for basic project information and identification of the document author is provided in the upper part of this form. This should match the information contained in the Basic Project Information section of the HVAC Systems Summary (H-1) form.

Prescriptive Requirements

Each of the requirements is organized in a similar fashion. A major check box certifies compliance with each requirement. Each one of these is followed by a series of minor check boxes that are used to identify exceptions to that requirement. All of the major check boxes must be filled in with either a check, "X," or "N/A." In addition, a check or "X" should be placed in each applicable exception box. On the line adjacent to these exception descriptions, identify the systems or equipment to which the exception applies.

HVAC EQUIPMENT SUMMARY H-3

Project Information

A box for basic project information and identification of the document author is provided in the upper part of this form. This should match the information contained in the Basic Project Information section of the HVAC Equipment Summary (H-1) form.

Equipment Efficiency Information

Each piece of HVAC equipment that has efficiency requirements under ASHRAE 90.1 should be listed here. See Code Appendix A63.20 for reprinted standards.

- System ID Number: List the system identification number or zone identification number or other descriptor.
- Unit Type and Category: List the unit type and category from the appropriate table.
- Table Number: Give the table number, Table A63.20-1 through A63.20-15 of the Code Appendix, on which the equipment and its required efficiency are listed.
- Rated Output (Btu/h): This is the unit capacity (heating or cooling as appropriate) at rated conditions. The rating conditions should match those from the reference column of the corresponding table.
- Unit Efficiency: For each unit, list the efficiency of the selected unit at rated conditions on the left and the required minimum efficiency from the corresponding table on the right. Under "Rating Units" place "EER," "IPLV," "ET," etc., as applicable.

HVAC SYSTEMS WORKSHEET

H-1



Transaction ID #	Submitter's Name		
Owner's Name	Date		
Building Location (Number & Street)	City	Village	Township of

Check here if using System Analysis Design (see Comm 63.70-72)

	Basic Requirements Checklist	Additional Data
Design	<input type="checkbox"/> Load calculations involve the use of the minimum interior temperatures of Table Comm 64.05 for heating and Comm 63.23(2) for cooling as well as meet or exceed the minimum heating or maximum cooling outdoor design temperatures given in code. Comm 63.23(3) <input type="checkbox"/> Cooling pull-down/heating pick-up loads were either calculated or did not exceed 10%/30% of design load. Comm 63.23 (7) <input type="checkbox"/> Equipment is properly sized. Comm 63.24 <input type="checkbox"/> Process loads are served by separate systems from comfort conditioning loads. Comm 63.25 <input type="checkbox"/> HVAC fan and pumping system motors meet efficiency standards. Comm 63.32	HVAC Prescriptive Worksheet (H-2)
Controls	<input type="checkbox"/> Temperature controls are provided as required: one for each HVAC system and individual controls for each thermal zone. Comm 63.26 <input type="checkbox"/> Thermostatic controls meet the setpoint adjustment requirements: heating down to 55°F, cooling setpoints up to 85°F, and deadbands of 5°F minimum. Comm 63.26 <input type="checkbox"/> Systems do not reheat, recool or mix air. Comm 63.27* <input type="checkbox"/> Variable volume systems have minimum stops adjusted as required. Comm 63.27* <input type="checkbox"/> Each system that does not need to operate continuously is provided with either automatic time or setback/setup controls. Comm 63.27 (3) <input type="checkbox"/> Ventilation supply systems and exhaust systems are provided with either gravity or motorized dampers as required to limit infiltration during off hours. Comm 64.19 (5) <input type="checkbox"/> Combustion air dampers provided per Comm 64.09 (2). <input type="checkbox"/> A humidistat shall be provided if a system is equipped with a means for adding moisture to maintain specific humidity levels in a zone or zones. Comm 63.28 <input type="checkbox"/> Fan cooling systems employ air or water economizer controls. Comm 63.31* <input type="checkbox"/> Heat pumps with supplementary heaters have controls to prevent heater operation when heating load can be met by heat pump. Comm 63.22	
Completion & Construction	<input type="checkbox"/> Pipe insulation meets the requirements of Comm Table 63.29-1. Duct insulation meets the requirements of Table 63.29-2. Comm 63.29 <input type="checkbox"/> The plans or specifications spell out the requirements for leakage testing ductwork. Comm 64.34 <input type="checkbox"/> Low and medium pressure supply ductwork which is located outside of the conditioned space is sealed in accordance with SMACNA Seal Class C. Comm 64.34 <input type="checkbox"/> Complying air and water system balancing procedures are spelled out on the plans or in the specifications. Comm 64.53 <input type="checkbox"/> Testing, adjusting and calibration of control systems is spelled out on the plans or in the specifications. Comm 64.43 and Comm 64.53 <input type="checkbox"/> Plans or specifications require that equipment is provided with operation and maintenance manuals and system schematics. Comm 64.52	

Special Considerations: Heat recovery utilized Continuous system operation required

* If the ASHRAE 90.1 Energy Cost Budget method is used for system analysis design, these items do not have to be met prescriptively. Complete documentation must be provided.

The information you provide may be used by other agency programs [Privacy Law, s. 15.04 (1)(m)].

SBD-10375 (R.10/98)

HVAC PRESCRIPTIVE WORKSHEET

H-2



Transaction ID #	Submitter's Name		
Owner's Name	Date		
Building Location (Number & Street)	City	Village	Township of

Zone Controls - Constant Volume Systems Comm 63.27

Systems have controls which prevent simultaneous heating and cooling including: reheat, recool, mixing of heated and cooled airstreams, and simultaneous heating and cooling by separate systems within a zone.

System or Zone Number or ID

Exceptions

- 75% of reheat energy is from site-recovered or solar energy (provide documentation).
- System serves zones with process-driven humidity requirements.
- Multiple reheat systems serving multiple zones with controls or dual duct and multizone systems with controls to reset supply temperatures per Paragraphs (f), (g), or (n).
- Zones with a peak supply of 150 cfm or less or multizone systems with reheating or recooling limited to 5,000 cfm or 20%, whichever is less.

Zone Controls - Variable Volume Systems Comm 63.27

Before reheating or mixing of airstreams occur, zone controls must reduce the air supply to a minimum volume which is no greater than the largest of the following: (1) 30% of the peak supply volume, (2) the minimum required to meet ventilation requirements of Comm 64.05, or (3) 0.4 cfm/ft² of zone conditioned floor area.

System or Zone Number or ID

Exceptions

- There is no reheating or mixing of airstreams in these zones.
- Pressurization requirements prevent such reduction of airflow (provide documentation).
- 75% of reheat energy is from site-recovered or solar energy (provide documentation).
- System serves zones with process-driven humidity requirements.
- Zones with a peak supply of 150 cfm or less or multizone systems with reheating or recooling limited to 5,000 cfm or 20%, whichever is less.

Economizer Controls Comm 63.31

Fan-cooling systems are equipped with complying air or water economizers.

System Number or ID

Exceptions

- System capacity is less than either 2,000 cfm or 62,000 Btuh total cooling for a split system or less than 55,000 Btuh for all other types.
- Economizers would not save energy (provide documentation).
- Benefit of air economizer would be offset by increased energy use for humidity control.

A-63.05 (13) Daylit Area is the space on the floor that is the larger of (a) or (b);

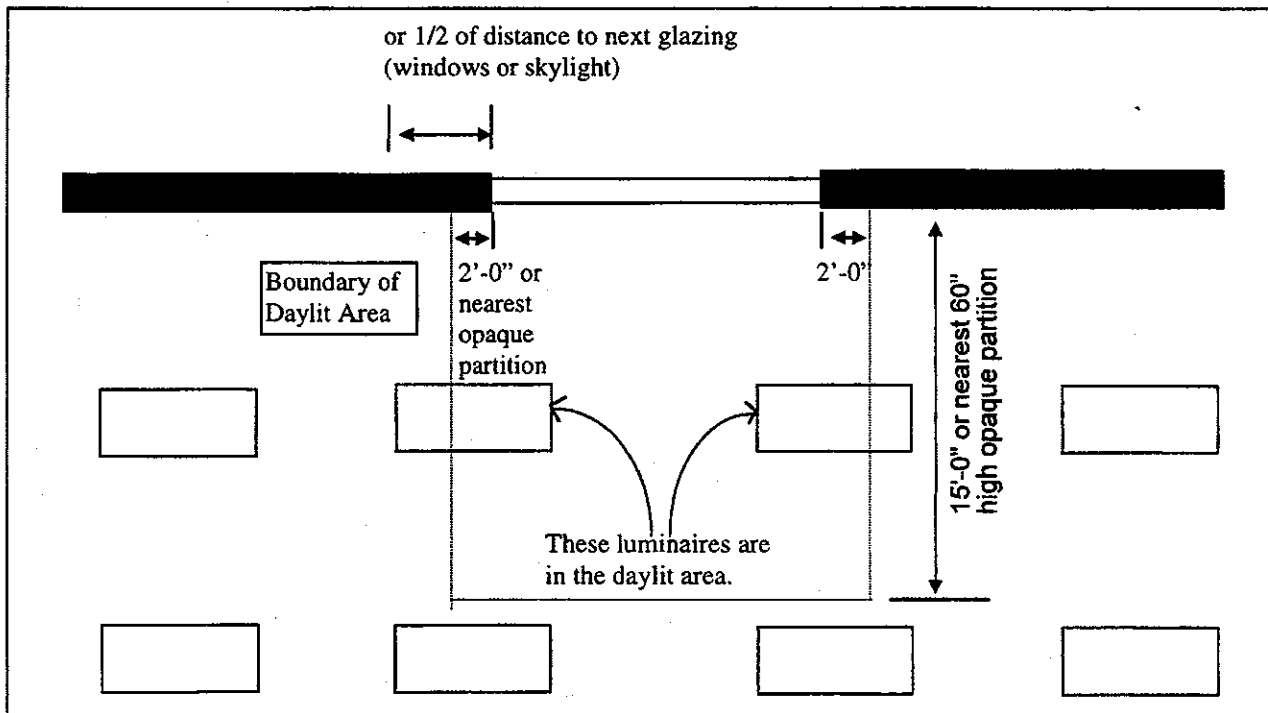
(a) 1. For areas daylit by vertical glazing, the daylit area has a length of 15 feet, or the distance on the floor, perpendicular to the glazing, to the nearest 60-inch or higher opaque partition, whichever is less; and a width of the window plus either 2 feet on each side, the distance to an opaque partition, or one-half the distance to the closest skylight or vertical glazing, whichever is least.

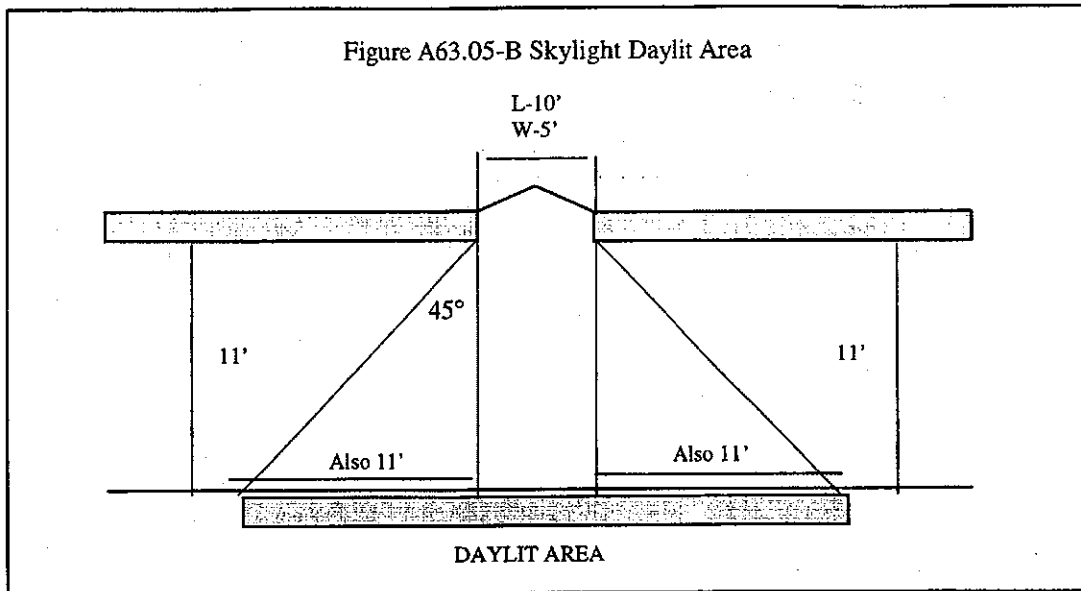
2. For areas daylit by horizontal glazing, the daylit area is the footprint of the skylight plus, in each of the lateral and longitudinal dimensions of the skylight, the lesser of the floor-to-ceiling height, the distance to the nearest 60-inch or higher opaque partition, or one-half the horizontal distance to the edge of the closest skylight or vertical glazing.

(b) The daylit area calculated using a method acceptable to the department. Such methods include DOE 2.1D and E, Superlite, Quicklite and other computer-based models that determine the daylit area based on modeling the features of the space.

Figures A63.05-A and A63.05-B illustrate the determination of daylit areas. The dimensions given in Figure A63.05-B are for demonstration only and will vary with each space.

Figure A63.05-A Window Daylit Area





A63.12 Section 8.4.8 of ASHRAE Standard 90.1 requires the following criteria to be met for exemption of skylights:

- 1) The U-value of the opaque portion of the roof must be less than the criteria given in Figure 63.15;
- 2) Automatic daylighting controls are required;
- 3) The skylight U-value must be less than 0.70 Btu/hr°F;
- 4) The skylight curb U-value must be less than 0.21 Btu/hr°F;
- 5) The air leakage must be less than 0.5 cfm/ft² of skylight;
- 6) The maximum area of the skylight will depend on the visible light transmittance and whether shading is provided for the skylight.

Table A63.12
Maximum Percent Skylight Area

Visible Light Transmission (VLT)	Light Level (fc)	Range of Lighting Power (W/ft ²)				
		<1.00	1.01-1.50	1.51-2.00	2.01-2.50	>2.50
0.75	30	2.3	3.4	4.5	5.6	5.6
	50	2.5	4.0	5.5	7.0	7.0
	70	2.8	4.6	6.4	8.2	8.2
0.50	30	3.6	5.1	6.6	8.1	8.1
	50	3.9	6.0	8.1	10.2	10.2
	70	4.2	6.9	9.6	12.3	12.3

The maximum allowable skylight area may be increased by 50 percent if shading devices are installed that block more than 50 percent of the solar gain during the peak cooling design condition. If this credit is taken, calculations on data must be prepared that show that solar gains are reduced by 50 percent. Exterior shading devices such as fixed louvers on opaque parapet walls will qualify if all direct solar radiation is eliminated during the peak design condition. Integral, interior or movable exterior shading devices will qualify if they cut the shading coefficient in half when closed.

This summary is provided for general information only. For exact compliance criteria, see the ASHRAE 90.1 Standard.

A63.15 (3)(b) Heat Capacity (HC) of an assembly is the amount of heat necessary to raise the temperature of all the components of a unit area in the assembly one degree F. It is calculated as the sum of the average thickness times the density times the specific heat for each component, and is expressed in Btu per square foot per degree F.

Heat capacity describes the thermal mass of an assembly. It is used in the prescriptive envelope requirements for walls and floors, where the U-value criterion is tied to the heat capacity of the assembly.

For a single layer, homogeneous wall or floor, such as poured concrete walls with no applied finish materials, heat capacity can be calculated by multiplying the weight of the wall (pounds per square foot) times the specific heat. For instance, a 6-inch concrete wall (specific heat = 0.20 Btu/lb°F) with a weight of 70 pounds per square foot would have an HC of 70 x 0.20 or 14 Btu/sf°F. The wall weight is calculated from the density (pounds per square foot); density divided by 12 and multiplied by the thickness (inches) gives the wall weight (pounds per square foot).

For assemblies made up of many layers, HC may be calculated separately for each layer and summed.

The following Table A63.15-1 lists the thermal properties of typical, thermally massive construction materials.

The heat capacity of unit masonry walls, such as those made of concrete block or brick, are too complicated to calculate by this method. Tables A63.15-2 and A63.15-3 include HC calculated for a large variety of masonry wall assemblies. These tables also give the U-value (U) and the total R-value (Rt) for the wall, including interior and exterior air films.

A63.15-1 Thermal Mass Properties

Matter	Conductivity Btu. in hr.sf.°F	Density (lbs/cf)	Specific Heat (Btu/lb°F)
Adobe	0.33	120	0.20
Heavy Concrete	0.98	140	0.20
Lightweight Concrete	0.36	85	0.20
Gypsum	0.09	50	0.26
Masonry Veneer	0.62	127	0.20
Masonry Infill	0.44	120	0.20
Concrete Masonry Unit	0.59	105	0.20
Grouted Concrete Masonry Unit	1.00	134	0.20
Stucco	0.47	105	0.20
Tile in Mortar	0.67	120	0.20
Solid Wood (fir)	0.07	32	0.33

From: ASHRAE Handbook of Fundamentals, Table 4, Chapter 22

**Table A63.15-2 Properties of Hollow Unit
Masonry Walls**

Thickness/Material Type			Core Treatment		
			Solid Grout	Partly Grouted with UngROUTED Cells	
				Empty	Insulated
12"	LW CMU	U	0.51	0.43	0.30
		R _t	2.0	2.3	3.3
		HC	23.0	14.8	14.8
	MW CMU	U	0.54	0.46	0.33
		R _t	1.9	2.2	3.0
		HC	23.9	15.6	15.6
	NW CMU	U	0.57	0.49	0.36
		R _t	1.8	2.0	2.8
		HC	24.8	16.5	16.5
10"	LW CMU	U	0.55	0.46	0.34
		R _t	1.8	2.2	2.9
		HC	18.9	12.6	12.6
	MW CMU	U	0.59	0.49	0.37
		R _t	1.7	2.1	2.7
		HC	19.7	13.4	13.4
	NW CMU	U	0.62	0.52	0.41
		R _t	1.6	1.9	2.4
		HC	20.5	14.2	14.2
8"	LW CMU	U	0.62	0.50	0.37
		R _t	1.6	2.0	2.7
		HC	15.1	9.9	9.9
	MW CMU	U	0.65	0.53	0.41
		R _t	1.5	1.9	2.4
		HC	15.7	10.5	10.5
	NW CMU	U	0.69	0.56	0.44
		R _t	1.4	1.8	2.3
		HC	16.3	11.1	11.1
	Clay Unit	U	0.57	0.47	0.39
		R _t	1.8	2.1	2.6
		HC	15.1	11.4	11.4
6"	LW CMU	U	0.68	0.54	0.44
		R _t	1.5	1.9	2.3
		HC	10.9	7.9	7.9
	MW CMU	U	0.72	0.58	0.48
		R _t	1.4	1.7	2.1
		HC	11.4	8.4	8.4
	NW CMU	U	0.76	0.61	0.52
		R _t	1.3	1.6	1.9
		HC	11.9	8.9	8.9
	Clay Unit	U	0.65	0.52	0.45
		R _t	1.5	1.9	2.2
		HC	11.1	8.6	8.6

Notes:

LW CMU is a Light Weight Concrete Masonry Unit per ASTM C 90, calculated at 105 PCF density.

MW CMU is a Medium Weight concrete Masonry Unit per ASTM C 90, calculated at 115 PCF density.

NW CMU is a Normal Weight Concrete Masonry Unit per ASTM C 90, calculated at 125 PCF density.

Clay Unit is a hollow clay unit per ASTM C 652, calculated at 130 PCF density.

Values include thermal resistance of interior air film ($R = 0.68$) and exterior air film ($R = 0.17$).

Calculations based on Energy Calculations and Data, CMACN, 1986.

Grouted Cells at 32" x 48" in partly grouted walls

[Source: Berkeley Solar Group; Concrete Masonry Association of California and Nevada (CMACN).]

**Table A63.15-3 Properties of Solid Unit
Masonry and Solid Concrete Walls**

Type	Layer Thickness in Inches										
	3	4	5	6	7	8	9	10	11	12	
LW CMU	U	na	0.71	0.64	na	na	na	na	na	na	na
	R _i	na	1.4	1.6	na	na	na	na	na	na	na
	HC	na	7.00	8.75	na	na	na	na	na	na	na
MW CMU	U	na	0.76	0.70	na	na	na	na	na	na	na
	R _i	na	1.3	1.4	na	na	na	na	na	na	na
	HC	na	7.67	9.58	na	na	na	na	na	na	na
NW CMU	U	0.89	0.82	0.76	na	na	na	na	na	na	na
	R _i	1.1	1.2	1.3	na	na	na	na	na	na	na
	HC	6.25	8.33	10.42	na	na	na	na	na	na	na
ClayUnit	U	0.80	0.72	0.66	na	na	na	na	na	na	na
	R _i	1.3	1.4	1.5	na	na	na	na	na	na	na
	HC	6.30	8.40	10.43	na	na	na	na	na	na	na
Concrete	U	0.96	0.91	0.86	0.82	0.78	0.74	0.71	0.68	0.65	0.63
	R _i	1.0	1.1	1.2	1.2	1.3	1.4	1.4	1.5	1.5	1.6
	HC	7.20	9.60	12.00	14.40	16.80	19.20	21.60	24.00	26.40	28.80

Notes:

LW CMU is a Light Weight Concrete Masonry Unit per ASTM C 90 or 55, calculated at 105 PCF density.

MW CMU is a Medium Weight concrete Masonry Unit per ASTM C 90 or 55, calculated at 115 PCF density.

NW CMU is a Normal Weight Concrete Masonry Unit per ASTM C 90 or 55, calculated at 125 PCF density.

Clay Brick is a clay unit per ASTM C 62, calculated at 130 PCF density.

Concrete is structural poured or precast concrete, calculated at 144 PCF density.

Calculations based on Energy Calculations and Data, CMACN, 1986.

Values include thermal resistance of interior air film (R = 0.68) and exterior air film (R = 0.17).

[Source: Berkeley Solar Group; Concrete Masonry Association of California and Nevada (CMACN).]

A-63.18 (2)(a) 3.

Default U-Values for Wood and Steel Swinging Doors Btu/(h-ft²-°F) - Part I

Nominal Thickness (Inches)	Description	No. Storm Door	Wood Storm Door ^c	Metal Storm Door ^d
Wood Doors^{a,b}				
1 3/8	Panel door with 7/16" panels ^e	0.57	0.33	0.37
1 3/8	Hollow-core flush door	0.47	0.30	0.32
1 3/8	Solid-core flush door	0.39	0.26	0.28
1 3/4	Panel door with 7/16" panels ^e	0.54	0.32	0.36
1 3/4	Hollow-core flush door	0.46	0.29	0.32
1 3/4	Panel door with 1 1/8" panels ^e	0.39	0.26	0.28
1 3/4	Solid-core flush door	0.33	0.25	0.28
2 1/4	Solid-core flush door	0.27	0.20	0.21
Steel Doors^b				
1 3/4	Fiberglass or mineral wool core with steel stiffeners, no thermal break ^f	0.60	na	na
1 3/4	Paper honeycomb core without thermal break ^f	0.56	na	na
1 3/4	Solid urethane foam core without thermal break ^f	0.40	na	na
1 3/4	Solid fire-rated mineral fiberboard core without thermal break ^f	0.38	na	na
1 3/4	Polystyrene core without thermal break (18 gage Commercial steel) ^f	0.35	na	na
1 3/4	Polyurethane core without thermal break (18 gage Commercial steel) ^f	0.29	na	na
1 3/4	Polyurethane core without thermal break (24 gage Commercial steel) ^f	0.29	na	na
1 3/4	Polyurethane core with thermal break and perimeter (24 gage Commercial steel) ^f	0.20	na	na
1 3/4	Solid urethane foam core with thermal break ^a	0.19	0.16	0.17

Note: All U-Values for exterior doors in this table are for doors with no glazing, except for the storm doors which are in addition to the main exterior door. Any glazing area in exterior doors shall be included with the appropriate glass type and analyzed as fenestration. Interpolation and moderate extrapolation are permitted for door thicknesses other than those specified. In order to take credit for a thermal break, the door must have a thermal break in both the door slab and the frame.

- a Values are based on a nominal 32" by 80" door size with no glazing.
- b U-values include the thermal resistance of air films. Outside air conditions: 15 mph wind speed, 0°F air temperature; inside air conditions: natural convection, 70°F air temperature.
- c Values for wood storm door are for approximately 50% glass area.
- d Values for metal storm door are for any percent glass area.
- e 55% panel area.
- f ASTM C 236 hotbox data on a nominal 3' x 7' door size with no glazing.

Default U-Values for Sliding and Roll-Up Doors Btu/h-ft²-°F) - Part II

Door Description	Overall U-Factor
Uninsulated, single-layer	1.15
Nominal 2" thick with 1 3/4" polyurethane foam core and vinyl thermal breaks and section joint seals	0.14
Nominal 3" thick with 2 7/8" expanded polystyrene core and continuous vinyl extrusion to form a thermal break and weather-tight seal along section joint	0.12
Other doors	Use value from most similar swinging door above

Note: See s. Comm 51.06 for thermal barrier requirements for foam plastic insulation.

A63.20 Tables A63.20-1 through 10 specify the ASHRAE 90.1-1989 efficiency standards for equipment not covered by federal efficiency standards, but are covered by s. Comm 63.20.

Table A63.20-1
Standard Rating Conditions and Minimum Performance,
Unitary Air Conditioners and Heat Pumps
--Air-Cooled, Electrically Operated, <135,000 Btu/h Cooling Capacity--
Except Packaged Terminal and Room Air Conditioners

Reference Standards ^a	Category	Sub-Category & Rating Condition (Outdoor Temp. °F)	Minimum Performance ^c
ARI 210/240-89	<65,000 Btu/h Cooling Capacity Cooling Mode ^b	<u>Seasonal Rating</u> Split System Single Package	10.0 SEER 9.7 SEER
	≥65,000 and <135,000 Btu/h Cooling Mode	Standard Rating (95°F db)	8.9 EER
		Integrated Part Load Value (80°F db)	8.3 IPLV
	<65,000 Btu/h Cooling Capacity Heating Mode (Heat Pump) ^b	<u>Seasonal Rating</u> Split System Single Package	6.8 HSPF 6.6 HSPF
≥65,000 and <135,000 Btu/h Cooling Capacity Heating Mode	<u>Split System & Single Package</u>		
	High Temp. Rating (47°F db/43°F wb) Low Temp. Rating (17°F db/15°F wb)		3.0 COP 2.0 COP

^a For detailed references, see ASHRAE Standard 90.1.

^b Exception: the following equipment is not covered by s. Comm 63.20, but is covered by the National Appliance Energy Conservation Act (NAECA) of 1987 (Public Law 100-12): central air conditioners other than packaged terminal air conditioners which are powered by single phase electric current, air cooled, rated below 65,000 Btu per hour, not contained within the same cabinet as a furnace, the rated capacity of which is above 225,000 Btu per hour, and is a heat pump or a cooling unit only; and Heat pumps other than packaged terminal heat pumps which consist of one or more assemblies, powered by single-phase electric current, rated below 65,000 Btu per hour, utilizing an indoor conditioning coil, compressor, and refrigerant-to-outdoor air heat exchanger to provide air heating, and may also provide air cooling, dehumidifying, humidifying circulating, and air cleaning.

^c COP = Coefficient of Performance, EER = Energy Efficiency Ratio, IPLV = Integrated Part Load Value. See reference documents for detailed definitions.

Table A63.20-2

Standard Rating Conditions and Minimum Performance, Unitary Air Conditioners and Heat Pumps--Evaporatively Cooled, Electrically Operated, Cooling Mode <135,000 Btu/h Cooling Capacity--Except Packaged Terminal and Room Air Conditioners

Reference Standards ^a	Category	Rating Condition °F		Minimum Performance ^b
		Indoor Temp.	Outdoor Temp.	
ARI 210/240-89	<65,000 Btu/h Cooling Capacity	Standard Rating 95°F db/75°F wb		9.3 EER
CTI 201 (86)	<65,000 Btu/h	Integrated Part Load Value (80°F db/67°F wb)		8.5 IPLV
	≥65,000 but <135,000 Btu/h	Standard Rating 95°F db/75°F wb		10.5 EER
	≥65,000 but <135,000 Btu/h	Integrated Part Load Value (80°F db/67°F wb)		9.7 IPLV

^a For detailed references, see ASHRAE Standard 90.1.

^b EER = Energy Efficiency Ratio, IPLV = Integrated Part Load Value. See reference documents for detailed definitions.

Table A63.20-3

Standard Rating Conditions and Minimum Performance, Water-Cooled Air Conditioners and Heat Pumps -- Electrically Operated and Cooling Mode <135,000 Btu/h Cooling Capacity

Reference Standards ^a	Category	Rating Condition °F		Minimum Performance ^b
		Indoor Air Temp.	Entering Water Temp.	
Water-Source Heat Pump	<65,000 Btu/h Cooling Capacity	Standard Rating 85		9.3 EER
		Low Temperature Rating 75		10.2 EER
ARI 320-86 CTI 201 (86)	≥65,000 but <135,000 Btu/h Cooling Capacity	Standard Rating 85		10.5 EER
Groundwater Source Heat Pumps ARI 325-85	<135,000 Btu/h Cooling Capacity	Standard Rating 70		11.0 EER
		Low Temperature Rating 50		11.5 EER
Water-Cooled Unitary Air Conditioners ARI 210/240-89 CTI 201 (86)	<65,000 Btu/h Cooling Capacity	Standard Rating 85		9.3 EER
		Integrated Part Load Value 75		8.3 IPLV
	≥65,000 <135,000 Btu/h Cooling Capacity	Standard Rating 85		10.5 EER

^a For detailed references, see ASHRAE Standard 90.1.

^b EER = Energy Efficiency Ratio, IPLV = Integrated Part Load Value. See reference documents for detailed definitions.

Table A63.20-4
Standard Rating Conditions and Minimum Performance, Packaged Terminal Air
Conditioners and Heat Pumps--Air-Cooled, Electrically Operated^a

Reference Standards ^c	Category PTACs & PTAC Heat Pumps	Sub-Category & Rating Conditions (Outdoor Temp. °F)	Efficiency Rating	Minimum Performance ^b
ARI 310-90	Cooling Mode	Standard Rating (95°F db)	EER	10.0 - (0.16 x Cap./1000)
		Low Temp. Rating (82°F db)	EER	12.2 - (0.20 x Cap./1000)
ARI 380-90	Heating Mode	Standard Rating (47°F db/43°F wb)	COP	2.9 - (0.026 x Cap./1000)

^a For multicapacity equipment, the minimum performance shall apply to each capacity step provided. Multicapacity refers to manufacturer published ratings for more than one capacity mode allowed by the product's controls.

^b Cap. means the rated cooling capacity of the product in Btu/h in accordance with the cited ARI Standard. If the unit's capacity is less than 7000 Btu/h, use 7000 Btu/h in the calculation. If the unit's capacity is greater than 15,000 Btu/h, use 15,000 Btu/h in the calculation. COP = Coefficient of Performance, EER = Energy Efficiency Ratio. See reference documents for detailed definitions.

^c For detailed references, see ASHRAE Standard 90.1.

Table A63.20-5
Standard Rating Conditions and Minimum Performance,
Water-Source and Groundwater-Source Heat Pumps
--Electrically Operated, <135,000 Btu/h Cooling Capacity

Reference Standards ^c	Rating Condition °F ^a	Minimum Performance ^d
Water-Source Heat Pumps ARI 320-86 CTI 201-(86)	<u>Standard Rating</u> 70°F Entering Water ^b	3.8 COP
Groundwater-Source Heat Pumps ARI 325-85	1. High Temperature Rating 70°F Entering Water ^b	3.4 COP
	2. Low Temperature Rating 50°F Entering Water ^b	3.0 COP

^a Air entering indoor section 70°F db/60°F wb (max.)

^b Water flow rate per manufacturer's specifications.

^c For detailed references, see ASHRAE Standard 90.1.

^d COP = Coefficient of Performance. See reference documents for detailed definitions.

Table A63.20-6
Standard Rating Conditions and Minimum Performance,
Large Unitary Air Conditioners and Heat Pumps--
Electrically Operated >135,000 Btu/h Cooling Capacity

Category Reference Standards ^c	Efficiency Rating ^d	Minimum Performance	
		≤760,000 Btu/h: 8.5	>760,000 Btu/h: 8.2
Air Conditioners ^a Air Cooled ARI 360-86	EER		
	IPLV		7.5
Air Conditioners ^a Water/Evaporatively Cooled ARI 360-86 CTI 201-86	EER		9.6
	IPLV		9.0
Heat Pumps ^a Air Cooled-Cooling Air Cooled-Heating ARI 340-86	EER	<760,000 Btu/h: 8.5	≥760,000 Btu/h: 8.2
	IPLV		7.5
	COP (47°F)		2.9
	COP (17°F)		2.0
Condensing Units ^b Air Cooled ARI 365-87	EER		9.9
	IPLV		11.0
Condensing Units ^b Water/Evaporatively Cooled ARI 365-87 CTI 201-86	EER		12.9
	IPLV		12.9

^a For units that have a heating section, deduct 0.2 from all required EERs and IPLVs

^b Condensing unit requirements are based on single-number ratings defined in paragraph 5.1.3.2 of ARI Standard 365.

^c For detailed references, see ASHRAE Standard 90.1.

^d COP = Coefficient of Performance, EER = Energy Efficiency Ratio, IPLV = Integrated Part Load Value. See reference documents for detailed definitions.

Table A63.20-7
Standard Rating Conditions and Minimum Performance,
Water Chilling Packages -- Water and Air Cooled and Electrically Operated

Reference Standards ^b	Category	Efficiency Rating ^c	Minimum Performance
ARI 550-90	Water-Cooled		
	≥300 Tons	COP	5.2 ^a
		IPLV	5.3 ^a
	≥150 Tons but <300 Tons	COP	4.2
		IPLV	4.5
	<150 Tons	COP	3.8
IPLV		3.9	
ARI 590-86	Air-Cooled With Condenser		
CTI 201-86	≥150 Tons	COP	2.5
		IPLV	2.5
<150 Tons	COP	2.7	
	IPLV	2.8	
	Air-Cooled Without Condenser		
	All Capacities	COP	3.1
		IPLV	3.2

^a Where R-22, or CFC refrigerants with ozone depletion factors less than or equal to those for R-22 is used, these requirements are reduced to 4.7 COP and 4.8 IPLV.

^b For detailed references, see ASHRAE Standard 90.1.

^c COP = Coefficient of Performance, EER = Energy Efficiency Ratio, IPLV = Integrated Part Load Value. See reference documents for detailed definitions.

Table A63.20-8
Standard Rating Conditions and Minimum Performance,
Gas- and Oil-Fired Boilers

Reference ^b	Category	Rating Condition	Minimum Performance ^c
ANSI Z21.13-87 H.I. Htg. Boiler Std. 86 ASME PTC 4.1-64 U.L. 795-73	Gas-Fired ≥300,000 Btu/h	1. Max. Rated Capacity ^a Steady-State	E _c 80%
		2. Min. Rated Capacity ^a Steady-State	E _c 80%
U.L. 726-90 H.I. Htg. Boiler Std. 86 ASME PTC 4.1-64	Oil-Fired ≥300,000 Btu/h	1. Max. Rated Capacity ^a Steady-State	E _c 83%
		2. Min. Rated Capacity ^a Steady-State	E _c 83%
H.I. Htg. Boiler Std. 86 ASME PTC 4.1-64	Oil-Fired (Residual) ≥300,000 Btu/h	1. Max. Rated Capacity ^a Steady-State	E _c 83%
		2. Min. Rated Capacity ^a Steady-State	E _c 83%

^a Provided and allowed by the controls.

^b For detailed references, see ASHRAE Standard 90.1.

^cE_c = Combustion efficiency, 100%-flue losses.

Table A63.20-9
Standard Rating Conditions and Minimum Performance,
Warm Air Furnaces and Combination Warm Air
Furnaces/Air Conditioning Units

Reference ^b	Category	Rating Condition	Minimum Performance ^c
ANSI Z21.47-90	Gas-Fired ≥225,000 Btu/h	1. Max. Rated Capacity ^a Steady-State	E _t 80%
		2. Min. Rated Capacity ^a Steady-State	E _t 78%
U.L. 727-86	Oil-Fired ^d ≥225,000 Btu/h	1. Max. Rated Capacity ^a Steady-State	E _t 81%
		2. Min. Rated Capacity ^a Steady-State	E _t 81%

^a Provided and allowed by the controls.

^b For detailed references, see ASHRAE Standard 90.1.

^cE_t = Thermal efficiency, 100%-flue losses. See referenced document for detailed definition.

Table A63.20-10
Warm Air Duct Furnaces and Unit Heaters

Reference ^b	Category	Rating Condition	Minimum Performance ^c
ANSI Z83.9-90	Duct Furnaces Gas-Fired	1. Max. Rated Capacity ^a Steady-State	E _t 78%
		2. Min. Rated Capacity ^a Steady-State	E _t 75%
ANSI Z83.8-90	Unit Heaters Gas-Fired	1. Max. Rated Capacity ^a Steady-State	E _t 78%
		2. Min. Rated Capacity ^a Steady-State	E _t 74%
U.L. 731-88	Unit Heaters Oil-Fired	1. Max. Rated Capacity ^a Steady-State	E _t 81%
		2. Min. Rated Capacity ^a Steady-State	E _t 81%

^a Provided and allowed by the controls.

^b For detailed references, see ASHRAE Standard 90.1.

^cE_t = Thermal efficiency, 100%-flue losses. See reference document for detailed definition.

Equipment efficiencies for the following appliances are established under federal Department of Energy rules 10 cfr Part 430 - Energy Conservation Program for Consumer Products and are not contained in this code:

Central air conditioners other than packaged terminal air conditioners which are powered by single phase electric current, air cooled, rated below 65,000 Btu per hour, not contained within the same cabinet as a furnace, the rated capacity of which is above 225,000 Btu per hour, and is a heat pump or a cooling unit only.

Furnaces which utilize only single-phase electric current, or single-phase electric current or DC current in conjunction with natural gas, propane, or home heating oil, and which comply with the following:

- (a) Are designed to be the principal heating sources for the living space of a residence;
- (b) Are not contained within the same cabinet with a central air conditioner whose rated cooling capacity is above 65,000 Btu per hour;
- (c) Are electric central furnaces, electric boilers, forced-air central furnaces; gravity central furnaces, or low pressure steam or hot water boilers, and
- (d) Have a heat input rate of less than 300,000 Btu per hour for electric boilers and low pressure steam or hot water boilers and less than 225,000 Btu per hour for forced-air central furnaces, gravity central furnaces, and electric central furnaces, gravity central furnaces, and electric central furnaces.

Heat pumps other than packaged terminal heat pumps which consist of one or more assemblies, powered by single-phase electric current, rated below 65,000 Btu per hour, utilizing an indoor conditioning coil, compressor, and refrigerant-to-outdoor air heat exchanger to provide air heating, and may also provide air cooling, dehumidifying, humidifying circulating, and air cleaning.

Direct heating equipment which is self-contained, and provides heat directly to the space proximate to the heater by gravity or fan circulation without duct connections.

The Department of Energy rules, section 430.31, requires the following efficiencies for heating and cooling equipment and water heaters.

**Table A63.20-11
Room Air Conditioners**

Product Class	Energy Efficiency Ratio
1. Without reverse cycle and with louvered sides less than 6,000 Btu	8.0
2. Without reverse cycle and with louvered sides 6,000 to 7,999 Btu	8.5
3. Without reverse cycle and with louvered sides 8,000 to 13,999 Btu	9.0
4. Without reverse cycle and with louvered sides 14,000 to 19,999 Btu	8.8
5. Without reverse cycle and with louvered sides 20,000 and more Btu	8.2
6. Without reverse cycle and without louvered sides less than 6,000 Btu	8.0
7. Without reverse cycle and without louvered sides 6,000 to 7,999 Btu	8.5
8. Without reverse cycle and without louvered sides 8,000 to 13,999 Btu	8.5
9. Without reverse cycle and without louvered sides 14,000 to 19,999 Btu	8.5
10. Without reverse cycle and without louvered sides 20,000 and more Btu	8.2
11. With reverse cycle and with louvered sides	8.5
12. With reverse cycle and without louvered sides	8.0

**Table A63.20-12
Central Air Conditioners and
Central Heat Pumps**

Product Class	Seasonal Energy Efficiency Ratio	Heating Seasonal Performance Factor
1. Split systems	10.0	6.8
2. Single package systems	9.7	6.6

Table A63.20-13
Water Heaters

Product Class	Energy Factor
1. Gas water heater	0.62-(.0019 x rated storage volume in gallons)
2. Oil water heater	0.59-(.0019 x rated storage volume in gallons)
3. Electric water heater	0.93-(.00132 x rated volume storage in gallons)

Note: Rated storage volume = the water storage capacity of a water heater, in gallons, as specified by the manufacturer.

Table A63.20-14
Furnaces

Product Class	AFUE ¹ (percent)
1. Furnaces (excluding classes noted below) (percent)	78
2. Mobile home furnaces (percent)	75
3. Small furnaces (other than furnaces designed solely for installation in mobile homes) having an input rate of less than 45,000 Btu/hr	
(A) Weatherized (outdoor)	78
(B) Nonweatherized (indoor)	78
4. Boilers (excluding gas steam) (percent)	80
5. Gas steam boilers (percent)	75

¹ Annual Fuel Utilization Efficiency, as determined in s. 430.22 (n)(2) of the DOE rules.

Table A63.20-15
Direct Heating Equipment

	Product Class	Annual Fuel Utilization Efficiency (percent)
1.	Gas wall fan type up to 42,000 Btu/hour	73
2.	Gas wall fan type over 42,000 Btu/hour	74
3.	Gas wall gravity type up to 10,000 Btu/hour	59
4.	Gas wall gravity type over 10,000 Btu/hour up to 12,000 Btu/hour	60
5.	Gas wall gravity type over 12,000 Btu/hour up to 15,000 Btu/hour	61
6.	Gas wall gravity type over 15,000 Btu/hour up to 19,000 Btu/hour	62
7.	Gas wall gravity type over 19,000 Btu/hour up to 27,000 Btu/hour	63
8.	Gas wall gravity type over 27,000 Btu/hour up to 46,000 Btu/hour	64
9.	Gas wall gravity type over 46,000 Btu/hour	65
10.	Gas floor up to 37,000 Btu/hour	56
11.	Gas floor over 37,000 Btu/hour	57
12.	Gas room up to 18,000 Btu/hour	57
13.	Gas room over 18,000 Btu/hour up to 20,000 Btu/hour	58
14.	Gas room over 20,000 Btu/hour up to 27,000 Btu/hour	63
15.	Gas room over 27,000 Btu/hour up to 46,000 Btu/hour	64
16.	Gas room over 46,000 Btu/hour	65

A-63.29 ALTERNATIVE HVAC PIPING INSULATION TYPES. Insulation thicknesses in Table 63.29-1 are based on insulation with thermal conductivities within the range listed in Table 63.29-1 for each fluid operating temperature range, rated in accordance with ASTM C335-84 at the mean temperature listed in the table. For insulation that has a conductivity outside the range shown in Table 63.29-1 for the applicable fluid operating temperature range at the mean rating temperature shown (when rounded to the nearest 0.01 Btu in./(h °F ft²)), the minimum thicknesses shall be determined in accordance with the equation given below:

$$T = PR[(1 + t/PR)K/k - 1]$$

where:

T = minimum insulation thickness for material with conductivity K, in.

PR = pipe actual outside radius, in.

t = insulation thickness from Table 63.29-1 in.

K = conductivity of alternate material at the mean rating temperature indicated in Table 63.29-1 for the applicable fluid temperature range, Btu in./(h ft² °F)

k = the lower value of the conductivity range listed in Table 63.29-1 for the applicable fluid temperature range, Btu in./(h ft² °F)

Table A63.45-1
Typical Lighting Power for Magnetically Ballasted Fluorescent Lamp-Ballast Systems (watts)

	4 Lamps 2 Ballasts		3 Lamps 2 Ballasts		3 Lamps Tandem-Wired Ballasts		2 Lamps 1 Ballast	
	ANSI	Enclosed	ANSI	Enclosed	ANSI	Enclosed	ANSI	Enclosed
	Standard Magnetic Energy Saving Ballasts							
31-watt FB31T8			105	97	104	96	69	64
32-watt F32T8	140	129	106	98	105	97	70	65
34-watt F40T12/ES	144	137	112	107	108	103	72	68
40-watt F40T12	176	160	134	121	129	117	88	80
40-watt FB40T12			134	121	129	117	86	78
40-watt F40T5 Twin Tube			130	120			86	79
60-watt F96T12/ES Slimline							123	
75-watt F96T12 Slimline							158	
95-watt F96T12/High Output/ES							199	
110-watt F96T12/High Output/ES							237	

Notes: Data listed are for standard energy efficient magnetic ballasts.

Values listed for 3-lamp systems with 2 magnetic ballasts have 1 single-lamp ballast and 1 double-lamp ballast.

Table A63.45-2
Typical Lighting Power for Electronically Ballasted Rapid-Start Fluorescent Lamp-Ballast Systems

Lamp/Ballast Combination	4 Lamps 1 Ballast		3 Lamps 1 Ballast		2 Lamps 1 Ballast		1 Lamp 1 Ballast	
	ANSI	Enclosed	ANSI	Enclosed	ANSI	Enclosed	ANSI	Enclosed
	265 mA T-8 Lamps							
17-watt F17T8					34	33	16	15
25-watt F25T8			66	63	46	44	23	22
32-watt F32T8	120	116	90	87	61	59	31	30
40-watt F40T8			108		73	71	39	
T-12 and T-10 Lamps								
25-watt F30T12/ES			77		49	47	27	25
30-watt F30T12			87		59	57	32	30
34-watt F40T12/ES	117		90	87	62	60	31	30
40-watt F40T10			109	106	73	71	39	38
40-watt F40T12	140		106	103	72	70	38	36
40-watt FB40T12			100	93	67	62		
85-watt F72T12 High Output					164		82	
95-watt F96T12/HO/ES					170			
110-watt F96T12/HO					201			
Twin Tube Biax Lamps								
36-watt FT36T5 Twin Tube			106		72		37	
39-watt FT39T5 Twin Tube			104		70		37	
40-watt FT40T5 Twin Tube				69	67		37	
50-watt FT50T5 Twin Tube			125		106		54	

Notes: Data listed represents averages of rapid-start products available in 1994 from established manufacturers of electronic ballasts.

Actual input wattages for these system may be tuned by using specific products and will differ from these values.

Systems shown have minimum 0.85 ballast factor.

ANSI values listed for fluorescent systems assume open air operation of lamps where there is no solid lens between the lamp and the lighted space. Open suspended fixtures and heat extract type recessed troffers will have similar input values.

Input wattage values for enclosed lamps are generally less than they are under ANSI conditions. It is important to note that while input wattage is reduced in enclosed fixtures, so is light output.

Table A63.45-3
Typical Lighting Power for Electronically Ballasted Instant-Start Fluorescent Lamp-Ballast Systems
(watts)

Lamp/Ballast Combination	4 Lamps 1 Ballast		3 Lamps 1 Ballast		2 Lamps 1 Ballast		1 Lamp 1 Ballast	
	ANSI	Enclosed	ANSI	Enclosed	ANSI	Enclosed	ANSI	Enclosed
265 mA T-8 Lamps								
17-watt F17T8	62	60	50	49	34	32	18	17
25-watt F25T8	87	85	68	67	48	46	28	27
31-watt FB31T8			88	79	61	55	31	30
32-watt F32T8	110	104	89	88	61	57	33	31
36-watt F36T8	150		112		78			
55-watt F96T8					110			
T-12 Slimline Lamps								
55-watt F72T12					109			
60-watt F96T12 Slimline/ES					110		72	
75-watt F96T12 Slimline					135		85	
Twin Tube Biax Lamps								
39-watt FT39T5					64		42	
40-watt FT40T5			103		72		43	
55-watt FT55T5 Twin Tube						115		

Notes: Data listed represents averages of rapid-start products available in 1994 from established manufacturers of electronic ballasts. Actual input wattages for these system may be tuned by using specific products and will differ from these values. Systems shown have minimum 0.85 ballast factor.

Table A63.45-4
Typical Lighting Power for Electronically Ballasted Low-Wattage Reduced-Output
Fluorescent Lamp-Ballast Systems (watts)

Lamp/Ballast Combination	4 Lamps		3 Lamps		2 Lamps		1 Lamp	
	1 Ballast		1 Ballast		1 Ballast		1 Ballast	
	ANSI Watts	Ballast Factor	ANSI Watts	Ballast Factor	ANSI Watts	Ballast Factor	ANSI Watts	Ballast Factor
17-watt F17T8	54(RS)	0.77			27(RS)	0.77	14(RS)	0.77
25-watt F25T8	80(IS)	0.82			41(RS)	0.77	21(RS)	0.77
	79(RS)	0.77						
32-watt F32T8	99(IS)	0.79	79(IS)	0.82	54(IS)	0.82	28(RS)	0.77
	101(RS)	0.77	78(RS)	0.75	55(RS)	0.79		
34-watt F40T12/ES	117	0.83	85	0.83	61	0.83	31	0.82
39-watt F39T5 Twin Tube			73(IS)	0.63	52(IS)	0.64		
40-watt F40T5 Twin Tube					60(RS)	0.7		
40-watt F40T8			69(IS)	0.8	66(IS)	0.82		
					69(RS)	0.80		
40-watt F40T12			85	0	61	0.73	57	
40-watt F40T10					72	0.84	37	0.84
59-watt F96T8					105	0.83		
85-watt F72T12/HO					160	0.80		
110-watt F96T12						190	0.8	

Notes: All systems with ballast factor of <0.85

RS = rapid start operation

IS = instant start operation

Ballast factor listed is typical for the average input wattage given for all available products. Note that reducing the ballast factor decreases light output in addition to reducing input wattage.

Table 63.45-5
Typical Lighting Power for Compact Fluorescent Lamps

Lamp Type	Ballast Type	Input Watts
5-watt Twin Tube	Reactor preheat	9
7-watt Twin Tube	Reactor preheat	11
9-watt Twin Tube	Reactor preheat	13
13-watt Twin Tube	Reactor preheat	17
9-watt Quad Tube	Reactor preheat	13
13-watt Quad Tube	Reactor preheat	17
10-watt Quad Tube	Autotransformer preheat	16
	Reactor preheat	13
13-watt Quad Tube	Autotransformer preheat	18
	Reactor preheat	16
15-watt Quad Tube	Reactor preheat	20
18-watt Quad Tube	Autotransformer preheat	25
	Reactor preheat	22
18-20-watt Twin Tube	370 mA preheat or rapid start	22
18-watt Twin Tube	270 MA rapid start	23
	265 mA electronic IS	17
20-watt Quad Tube	Reactor preheat	27
24-27-watt Twin Tube	340 mA rapid start	32
	265 mA electronic IS	21
26-watt Quad Tube	Autotransformer preheat	37
	Reactor preheat HPF	33
	Electronic HPF	23
27-watt Quad Tube	Reactor preheat	34

**Table A63.45-6
Typical Lighting Power for High-Intensity Discharge Lamps**

Lamp Watts	Ballast Watts	Fixture Input Watts
Mercury Vapor Lamps		
75	15	90
100	18	118
175	25	200
250	35	285
400	50	450
1,000	75	1,075
Metal Halide Lamps		
32	6	38
50	13	63
70	18	88
100	25	125
175	35	210
250	42	292
400	55	455
1,000	70	1,070
High Pressure Sodium Lamps		
35	8	43
50	13	63
70	18	88
100	30	130
150	38	188
250	50	300
400	65	465
1,000	90	1,090

Notes: Source: Pacific Gas & Electric

Figures listed represent average values taken from Osram-Sylvania, Philips, and General Electric lamp catalogs.

A-64.20 EQUIPMENT RATINGS AND SAFETY CONTROLS. The department recognizes the following reference standards for the testing and installation of heating and ventilating equipment:

- (1) American National Standards Institute, Inc., 1430 Broadway, New York, N.Y. 10018:
 - (a) GAS WATER HEATERS, Vol. I, ANSI Z21.10.1
 - (b) GAS WATER HEATERS, Vol. III, ANSI Z21.10.3
 - (c) GAS-FIRED ROOM HEATERS, Vol. I, ANSI Z21.11.1;
 - (d) GAS-FIRED LOW PRESSURE STEAM AND HOT WATER BOILERS, ANSI Z21.13;
 - (e) GAS UNIT HEATERS, ANSI Z21.16;
 - (f) DOMESTIC GAS CONVERSION BURNERS, ANSI Z21.17;
 - (g) GAS APPLIANCE PRESSURE REGULATORS, ANSI Z21.18;
 - (h) AUTOMATIC GAS IGNITION SYSTEMS AND COMPONENTS, ANSI Z21.20;
 - (i) AUTOMATIC GAS VALVES, ANSI Z21.21;
 - (j) RELIEF VALVES AND AUTOMATIC GAS SHUTOFF DEVICES FOR HOT WATER SYSTEMS, ANSIZ21.22;
 - (k) GAS APPLIANCE THERMOSTATS, ANSI Z21.23;
 - (l) GAS-FIRED DUCT FURNACES, ANSI Z21.34;
 - (m) GAS FILTERS ON APPLIANCES, ANSI Z21.35;
 - (n) GAS-FIRED GRAVITY AND FAN TYPE DIRECT VENT WALL FURNACES, ANSI Z21.44;
 - (o) GAS-FIRED GRAVITY AND FORCED AIR CENTRAL FURNACES, ANSI Z21.47;
 - (p) GAS-FIRED GRAVITY AND FAN TYPE FLOOR FURNACES, ANSI Z21.48;
 - (q) GAS-FIRED GRAVITY AND FAN TYPE VENTED WALL FURNACES, ANSI Z21.49;
 - (r) VENTED DECORATIVE GAS APPLIANCES, ANSI Z21.50;
 - (s) GAS-FIRED SINGLE FIREBOX BOILERS, ANSI Z21.52;
 - (t) GAS-FIRED HIGH PRESSURE STEAM AND HOT WATER BOILERS (Inputs not over 400,000 Btu/hour), ANSI Z21.59;
 - (u) DECORATIVE GAS APPLIANCES FOR INSTALLATION IN VENTED FIREPLACES, ANSIZ21.60;
 - (v) DIRECT VENT CENTRAL FURNACES, ANSI Z21.64;
 - (w) DIRECT GAS-FIRED MAKE-UP AIR HEATERS, ANSI Z83.4;
 - (x) GAS-FIRED HEAVY DUTY FORCED AIR HEATERS, ANSI Z83.5;
 - (y) GAS-FIRED INFRARED HEATERS, ANSI Z83.6;
 - (z) GAS UNIT HEATERS, ANSI Z83.8;
 - (aa) GAS-FIRED DUCT FURNACES, ANSI Z83.9;
 - (bb) DIRECT GAS-FIRED DOOR HEATERS, ANSI 283.17; and
 - (cc) DIRECT GAS-FIRED INDUSTRIAL AIR HEATERS, ANSI Z83.18.
- (2) Canadian Standards Association, Certification Division, Rexdale, Ontario Canada, M9W 1R3:
 - (a) Solid-Fuel Fired Appliances for Residential Use, CSAB 366M.
- (3) Energy Testing Laboratory of Maine, South Maine Vocational Technical Institute, South Portland, Maine 04106.
 - (a) Testing for Safety—Requirements and Test Procedures for Solid-Fuel Burning Central Heating Appliances and Combination Oil- and Solid-Fuel Burning Central Heating Appliances, ETLM Standard #78-1.
- (4) International Conference of Building Officials, Inc., 5360 South Workman Mill Road, Whittier, California 90601:
 - (a) Research Committee Acceptance Criteria for Fireplace Heat Exchangers.
- (5) Underwriters' Laboratories, Inc., 333 Pfingsten Road, Northbrook, Illinois 60062:
 - (a) CHIMNEYS, FACTORY-BUILT, RESIDENTIAL TYPE AND BUILDING HEATING APPLIANCES, UL 103;
 - (b) FACTORY BUILT FIREPLACES, UL 127;
 - (c) OIL BURNERS, UL 296;
 - (d) CONTROLS, PRIMARY SAFETY FOR GAS- AND OIL-FIRED APPLIANCES, UL 372;
 - (e) SOLID-FUEL FIRED CENTRAL FURNACES, UL 391;
 - (f) GAS VENTS, UL 441;

- (g) HEATING APPLIANCES, ELECTRIC, UL 499;
- (h) HEAT PUMPS, UL 559;
- (i) TYPE L LOW-TEMPERATURE VENTING SYSTEMS, UL 641;
- (j) OIL-FIRED BOILER ASSEMBLIES, UL 726;
- (k) OIL-FIRED CENTRAL FURNACES, UL 727;
- (l) OIL-FIRED FLOOR FURNACES, UL 729;
- (m) OIL-FIRED WALL FURNACES, UL 730;
- (n) OIL-FIRED UNIT HEATERS, UL 731;
- (o) HEATERS, AIR AND DIRECT-FIRED HEATERS, OIL-FIRED, UL 733;
- (p) FIREPLACE STOVES, UL 737;
- (q) COMMERCIAL-INDUSTRIAL GAS HEATING EQUIPMENT (Inputs over 400,000 Btu/hour), UL 795;
- (r) HEATERS, ELECTRIC, FOR USE IN HAZARDOUS LOCATIONS; Class I, Groups A, B, C and D, and Class II, Groups E, F and G, UL 823;
- (s) ELECTRIC BOILERS, UL 834;
- (t) HEATERS, ELECTRIC DRY BATH, UL 875;
- (u) FAN COIL UNITS AND ROOM FAN HEATER UNITS, UL 883;
- (v) OIL-BURNING STOVES, UL 896;
- (w) HEATERS, ELECTRIC AIR, UL 1025;
- (x) HEATING EQUIPMENT, ELECTRIC BASEBOARD, UL 1042;
- (y) HEATING EQUIPMENT, ELECTRIC CENTRAL AIR, UL 1096; and
- (z) ROOM HEATERS, SOLID-FUEL TYPE, UL 1482.

The table on the following page is a tabular summary of UL 296 and UL 795.e.

TABULAR SUMMARY UL STANDARD 296 AND UL STANDARD 795

FUNCTION/BURNER INPUTS	OIL BURNERS UL 296				COMMERCIAL/INDUSTRIAL GAS UL 795				
	3 GPH	7 GPH	20 GPH	Over 20 GPH 3 million Btu	Mechanical Draft Burners				ATM Draft
	400,000 Btu or less	1 million Btu or less	3 million Btu or less		Over 400,000 to 2,500,000	Over 2,500,000 to 5,000,000	Over 5,000,000 to 12,500,000	Over 12,500,000	
Prepurge timing	--	--	--	--	4	4	4	4	90 sec ³
Air changes	--	--	--	--	4	4	4	4	--
Interlock Controls (Recycle)	Yes	Yes	Yes	Yes	Yes	Yes	Yes	Yes	Yes
Proven combustion air	8	8	8	8	Yes	Yes	Yes	Yes	--
Valve seal overtravel ⁹	--	--	--	--	--	Optional	Yes	Yes	13
Low gas pressure	--	--	--	--	--	Yes ²⁰	Yes ²⁰	Yes ²⁰	13
High gas pressure	--	--	--	--	--	Yes ²⁰	Yes ²⁰	Yes ²⁰	13
Low fire start	11	11	11	11	11	11	11	11	13
High limit (press. or temp.)	Yes	Yes	Yes	Yes	Yes	Yes	Yes	Yes	Yes
Low water cutoff	Boilers ²¹	Boilers ²¹	Boilers ²¹	Boilers ²¹	Boilers	Boilers	Boilers	Boilers	13
Pilot - Intermittent	Optional	Optional	Optional	--	Optional	Optional	Optional	Optional	12
Pilot - Interrupted	19	19	19	Yes ⁵	Optional	Optional ²	Optional ²	Optional ²	2, 10
Direct spark ignition	Yes	Yes	Yes	5	--	--	--	--	--
System & sequence approved safety control	Yes	Yes	Yes	Yes	Yes	Yes	Yes	Yes	Yes
Approved safety shutoff valves (SSOV)	IN	BURNER	DESIGN	--	Yes ¹⁴	Yes ¹⁴	Yes ¹⁴	Yes ¹⁴	Yes ^{13, 14}
No vent valve	--	--	--	--	--	--	--	Yes	13
Pilot valve	18	18	18	Yes	Yes ⁵	Yes	Yes	Yes	Yes
Proved pilot	Optional	Optional	Optional	Yes	Yes	Yes	Yes	Yes	Yes
Trial for pilot	17	17	17	15 sec	15 sec	10 sec	10 sec	10 sec	13
Trial for main flame	90 sec ^{2, 17}	30 sec ^{2, 17}	15 sec ^{2, 17}	10/30 sec ⁷	15 sec ²²	10 sec	10 sec	10 sec	13
Flame failure response time	90 sec ¹⁷	4 sec max ^{15, 17}	4 sec max ^{15, 17}	4 sec max	4 sec max	4 sec max	4 sec max	2 sec max	13
Valve closing time (max.)	23	23	23	23	5 sec max	1 sec max	1 sec max	1 sec max	13
Supervise main flame	17	17	17	Yes	--	Yes ²	Yes ²	Yes ²	2, 10
Action on flame failure	Recycle optional ¹	1	1	Lockout or recycle	Lockout or recycle ⁵	Lockout	Lockout	Lockout	13
Action on limit open	Close SSOV	Close SSOV	Close SSOV	Close SSOV	Close SSOV	Close SSOV	Close SSOV	Close SSOV	13

See following page for footnotes.

FOOTNOTES TO TABULAR SUMMARY UL STANDARD 296 AND UL STANDARD 795:

SSOV=Safety shutoff valve

¹May relight if ignition is re-energized within 0.8 sec. See 15 and 16.

²Where intermittent pilot is desired, it is allowable to switch from pilot detector to main flame detector if main flame detector responds to main flame only.

³Without shutters, no prepurge required.

⁴Options (whichever is chosen, a minimum of 4 air changes must be provided):

- 30 sec at high fire rate; OR
- 60 sec at 1/2 high fire rate; OR
- 90 sec at 1/3 high fire rate.

⁵With 2-stage lightoff, direct ignition is permitted if first stage is 20 gph or less (requirements for 20 gph or less apply). Pilot is required if igniting more than 20 gph.

⁶Lockout on interrupted pilot applications; recycle on intermittent pilot applications.

⁷10 sec for distillate fuel (No. 1 or No. 2); 30 sec for residual fuel (No. 4, 5, 6).

⁸Conventional type pressure burner—none needed. Needed for applications with combustion air supply separate from oil supply.

⁹Valve seal overtravel switch can be wired into either the start circuit or pre-ignition interlock circuit (if provided).

¹⁰Interrupted pilot over 2.5 million Btuh if modulating or high/low firing rate. Otherwise over 5 million Btuh.

¹¹If low fire start is not proved, UL will test for smooth lightoff at high fire.

¹²Intermittent up to 5 million Btuh unless firing rate control is over 2,500,000 Btuh.

¹³Requirements same as mechanical draft burners.

¹⁴See Table 1 at end of footnotes for main gas valves.

¹⁵Up to 15 sec is permitted if intermittent ignition is employed, or if the ignition system is re-energized in not more than 0.8 sec after flame is extinguished.

¹⁶Up to 30 sec is permitted if intermittent ignition is employed, or if the ignition system is re-energized in not more than 0.8 sec after flame is extinguished.

¹⁷If proved pilot igniter is used, timings for over 20 gal flame safeguard control may be applied.

¹⁸Required for electrically ignited, gas-piloted systems.

¹⁹Interrupted pilot may be required if using flame safeguard control with a proved pilot. Otherwise, interrupted pilot is optional.

²¹Safety shutdown by this limit can be accomplished either by manual reset limits or in the programmer limit circuit.

²¹Required on boilers fired by oil burners—not a requirement of UL 296.

²²If intermittent pilot is used, no main burner flame-establishing period is required.

²³If a separate oil valve is used, it must close within 5 sec max when de-energized

TABLE 1—AUTOMATIC MAIN GAS SAFETY SHUT-OFF VALVES (SSOV) FOR MECHANICAL OR ATMOSPHERIC BURNERS—UL 795 REQUIREMENTS, EFFECTIVE OCTOBER 1, 1974

	400,000 to 2,500,000 BTUH	Over 2,500,000 to 5,000,000 BTUH	Over 5,000,000 to 12,500,000 BTUH	Over 12,500,000 BTUH
Main Valve Requirement	One valve rated for safety shutoff services(SSOV). Closing time 5 sec.	Two SSOV's in series, or one SSOV of the type incorporating a valve seal overtravel interlock. Closing time 1 sec max.	Two SSOV's in series, one of which incorporates a valve seal overtravel interlock. Closing time 1 sec max.	Two SSOV's in series, one of which incorporates a valve seal overtravel interlock. When fuel gas has specific gravity of less than 1.0, include a N.O. 3/4 inch or larger electrically operated valve in a vent line between the two SSOV's.

(

(

(

Chapters Comm 50-64

APPENDIX B

The material contained in this appendix is for clarification purposes only. The information is for the benefit of fire department inspectors making inspections pursuant to s. 101.14 (2) (b), Stats. (See s. Comm 50.02 Special Note #3)

Rule Number	Topic of Rule	Subject of Investigation
		Ch. Comm 50—Administration and Enforcement
50.25	Petition for Variance	1. Fire Department Position Statement (form SBD-9890)
		Ch. Comm 51—Definitions and Standards
51.02 (24)	Fire Blocking	1. Maintenance
51.047	Fire Rated Door Assemblies in Fire Rated Construction	1. Maintenance 2. Operation 3. Unobstructed
51.047 (6)	Door Closing Devices (Fire Doors)	1. Maintenance 2. Use of Fusible Link
51.0485	Fire Dampers	1. Maintenance
51.049	Fire Stopping	1. Maintenance
51.06 (3)	Foam Plastics (Thermal Barrier)	1. Proper Type and Correct Installation 2. Maintenance
51.08 (2)	Isolation of Hazards (All Occupancies)	1. Maintenance of Enclosure
51.15 (2)	Exit Doors	1. Maintenance 2. Unobstructed
51.15 (3)	Exit Hardware	1. Proper Type 2. Signage 3. Security Locks and Key Locks Open During Occupied Periods
51.15 (4)	Exit Doorway	1. Proper Size and Type 2. Maintenance
51.161	Handrails	1. Maintenance 2. Replacement, When Needed
51.162	Guardrails	1. Maintenance 2. Replacement, When Needed
51.165	Stairway Identification	1. Proper Posting 2. Proper Signage on Buildings Constructed After January 1, 1982
51.166	Stairway Discharge	1. Proper Type 2. Maintenance
51.167	Exiting Through Areas of Hazard	1. Proper Type
51.20	Fire Escapes	1. Maintenance
51.21	Standpipe & Hose Systems	1. Correct Installation 2. Maintenance
51.22	Fire Extinguishers	1. Proper Type 2. Location 3. Maintenance 4. Operational
51.23	Automatic Sprinklers	1. Water Supply 2. Obstruction of Sprinkler Heads 3. Location of Fire Department Connection 4. Accessibility of Fire Department Connection
51.24 (5)	Fire Alarm Systems	1. Operation & Testing 2. Location of Pull Stations
51.245	Smoke Detectors	1. Correct Installation 2. Maintenance of Detectors 3. Operational

Rule Number	Topic of Rule	Subject of Investigation
Ch. Comm 52—General Requirements		
52.01	Fire Prevention, Detection and Suppression (High Rise Construction)	1. Proper Installation 2. Maintenance 3. Operation and Testing
52.011	Automatic Fire Sprinkler Systems for Low Rise Buildings	1. Proper Installation 2. Maintenance 3. Operation and Testing
52.02 (2)	Fire Department Access Openings	1. Proper Type, Size and Location 2. Maintenance
52.07	Atriums	1. Proper Type 2. Smoke Control System 3. Maintenance 4. Test Reports
52.19	Gas and Oil Lamps	1. Proper Type and Clearance 2. Maintenance
52.20	Electrical Work	1. Electrical Check List
52.21	Location and Maintenance of Exits	1. Maintenance
52.22	Repairs	1. Conformance
52.23	Cleanliness	1. Conformance
Ch. Comm 54—Factory, Office, Mercantile		
54.01 (3)	Fire Door Closing Devices	1. Maintenance 2. Operational
54.02	Number and Location of Exits	1. Maintenance 2. Proper Exit Hardware
54.06	Exit Doors, Exit Lights	1. Maintenance of Illumination
54.07	Passageways	1. Maintain in Clear, Unobstructed Condition
54.08	Stairway Enclosure	1. Maintenance
54.11	Lighting	1. Maintenance of Illumination
54.145	Fire Extinguishers	1. For Buildings Constructed After January 1, 1982: A. Proper Type B. Location C. Maintenance D. Operational
54.15	Standpipes	1. Maintenance
54.17	Fire Alarm	1. Maintenance 2. Location of Pull Stations
54.20	No Smoking Signs	1. Proper Posting
Ch. Comm 55—Theaters and Assembly Halls		
55.07	Number and Location of Exits	1. Maintenance of Illumination
55.08	Type of Exits	1. Maintenance 2. To be Clear and Unobstructed
55.09	Stairways	1. Maintenance 2. To be Clear and Unobstructed
55.10	Exit Doorways and Doors	1. See 51.15
55.11	Exit Lights	1. Maintenance of Illumination
55.12	Required Exit Width	1. To be Unobstructed
55.14	Width of Aisles	1. To be Unobstructed
55.15	Lobbies and Foyers	1. To be Clear and Unobstructed
55.17	Obstructions	1. Maintenance
55.22 (3)	Proscenium Wall (Openings)	1. Proper Type 2. Maintenance
55.24	Automatic Smoke Outlets	1. Operation
55.33	Standpipes	1. Correct Installation 2. Maintenance

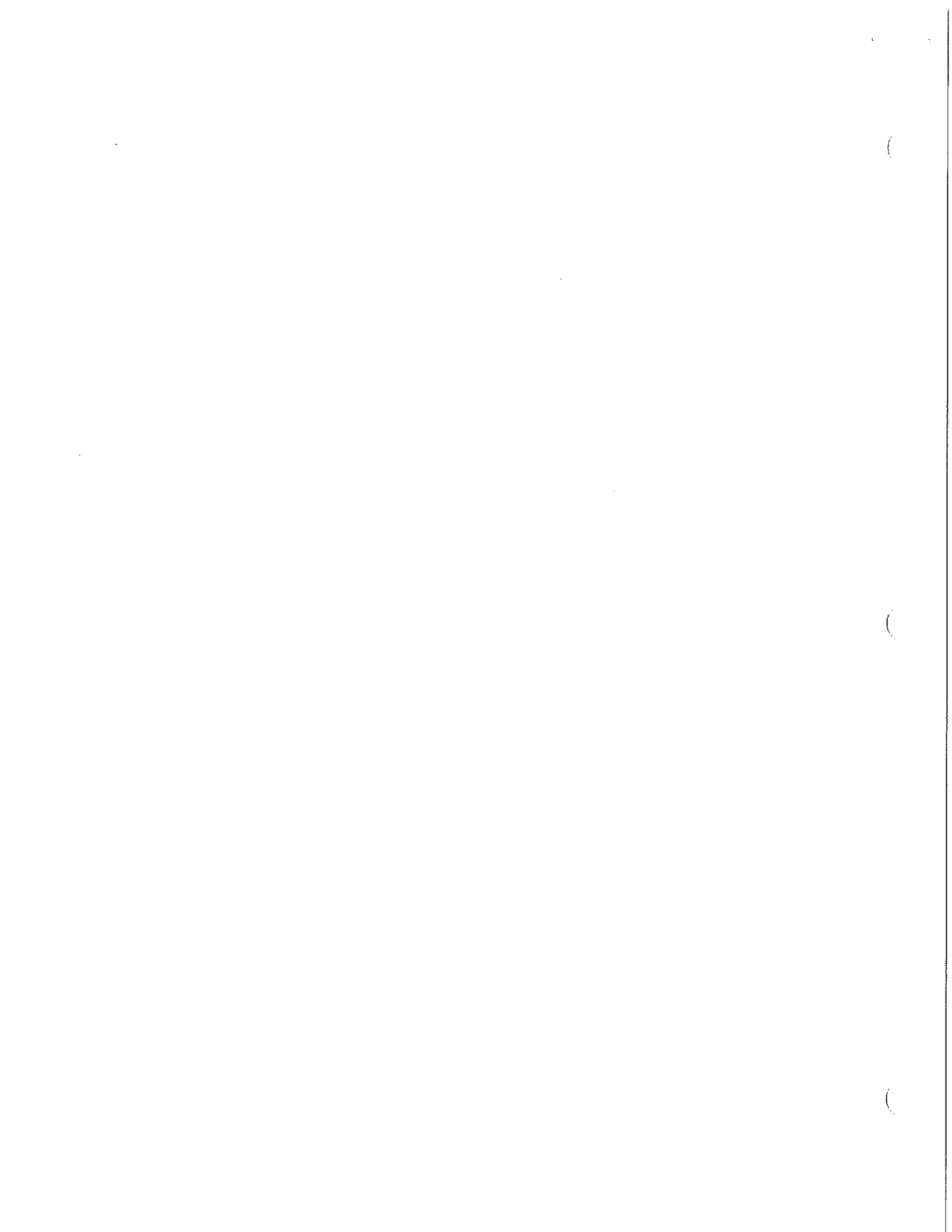
Rule Number	Topic of Rule	Subject of Investigation
55.33 (3)	Fire Extinguishers	1. For Buildings Constructed After January 1, 1982: A. Proper Type B. Location C. Maintenance D. Operational
55.43	Openings	1. Operational 2. Maintenance
55.45	Relief Outlets	1. Maintenance
55.46	Electric Wiring	1. Electrical Check List
55.50	Maintenance	1. Elimination of Fire Hazard
Ch. Comm 56—Schools and Places of Instruction		
56.03	Smoke Detection	1. For Existing Buildings with Basements not Protected by Automatic Sprinklers or Smoke Detectors as of January 1, 1982, Automatic Smoke Detector System in Basement Corridors by January 1, 1983. A. Correct Installation B. Maintenance of Detectors
56.06	Exit	1. Maintenance
56.06 (6)	Exit Lights	1. Maintenance of Illumination
56.07	Required Exit Width	1. To be Unobstructed
56.09	Passageways	1. To be Unobstructed 2. Maintenance of Exit Doors
56.18	Fire Extinguishers	1. Proper Type 2. Location 3. Maintenance 4. Operational
56.19	Fire Alarms	1. Operation of System 2. Location of Pull Stations
56.20	Standpipes	1. Correct Installation 2. Maintenance
56.34	Exit Doors and Lights	1. Maintenance of Doors 2. To be Clear and Unobstructed
56.38	Fire Alarms	1. Operational 2. Testing 3. Location of Pull Stations
56.43	Exit Doors and Exit Lights	1. Maintenance of Doors 2. To Be Clear and Unobstructed
56.46	Fire Alarms	1. Operational 2. Testing 3. Location of Pull Stations
Ch. Comm 57—Residential Occupancies		
57.01 (3)	Basement and Ground Floor Protection	1. Proper Installation 2. Maintenance
57.02	Allowable Height and Area (Corridor Door Hold-Open Device, Access Roadways)	1. Maintenance 2. Operational 3. Clear and Unobstructed
57.03	Number and Location of Exits	1. Maintenance 2. Proper Exit Hardware
57.05	Type of Exits	1. Maintenance 2. To be Clear and Unobstructed 3. Proper Illumination
57.08	Enclosure of Interior Stairways and Shafts	1. Maintenance of Enclosure
57.09	Passageways	1. To Be Clear and Unobstructed 2. Maintenance of Exit Doors
57.10	Illumination of Exits and Exit Signs	1. Maintenance of Illumination and Signs

Rule Number	Topic of Rule	Subject of Investigation
57.15	Standpipes	1. Correction Installation 2. Maintenance
57.16	Smoke Detectors – All Buildings Except CBRF	1. For Existing Buildings Constructed Before May 23, 1978, Specified Smoke Detectors by January 1, 1983. A. Correct Installation B. Maintenance of Detectors 2. For Buildings Constructed After January 1, 1983: A. Correction Installation B. Maintenance of Detectors C. Interconnection of Corridor/Stairway Detectors to Required Manual Fire Alarm System D. Corridor/Stairway Smoke Detectors Provided with Emergency Power, if Required for the Building
57.165	Smoke Detectors — CBRF	1. Correct Installation 2. Maintenance of Detectors 3. Interconnection of Stairway, Complete Corridor and Common Use Room Detectors 4. Interconnection of Sleeping Room Detectors if Smoking is Permitted
57.17	Fire Alarms	1. Operation of Systems 2. Location of Pull Stations
57.18	Fire Extinguishers	1. For Buildings Constructed After January 1, 1982: A. Proper Type B. Location C. Maintenance D. Operational
57.19	Rowhouse (Living Unit Separation)	1. Proper Installation 2. Maintenance
Ch. Comm 58—Health Care Facilities		
58.04–58.05	Number, Type and Location of Exits	1. Maintenance 2. Proper Exit Hardware
58.06	Stairs	1. Maintenance 2. To Be Clear and Unobstructed 3. Proper Illumination.
58.18	Marking of Means of Egress	1. Correct Signage 2. Proper Illumination
58.20	Key Locking Hardware	1. Correct Hardware Type and Installation 2. Building Satisfies Rules for Detention and Correctional Facilities 3. Maintenance
58.21–58.23	Protection of Openings	1. Maintenance
58.24	Isolation of Hazards	1. Maintenance of Enclosure and Required Automatic Sprinkler System
58.25	Rubbish Chutes and Laundry Chutes	1. Protection of Enclosure 2. Sprinkler System Maintenance
58.27	Detection, Alarm and Communication Systems	1. Operational 2. Testing 3. Location of Pull Stations 4. Correct Installation 5. Maintenance
58.28	Standpipes	1. Correct Installation 2. Maintenance
58.29	Automatic Sprinkler and Other Suppression Systems	1. Water Supply 2. Obstruction of Sprinkler Heads 3. Location and Accessibility of Fire Department Connection
58.30–58.31	Smoke Barriers, Corridor Walls	1. Correct Installation 2. Maintenance
Ch. Comm 58—Places of Detention		

Rule Number	Topic of Rule	Subject of Investigation
58.48-58.49	Number, Type and Location of Exits	1. Maintenance 2. Proper Exit Hardware
58.50-58.51	Stairways and Smokeproof Towers	1. Maintenance 2. To Be Clear and Unobstructed 3. Proper Illumination
58.575	Emergency Lighting	1. Proper Type 2. Maintenance
58.58	Marking of Means of Egress	1. Correct Signage 2. Proper Illumination
58.59	Door Locks	1. Correct Type and Installation 2. Maintenance
58.60-58.61	Protection of Openings	1. Maintenance
58.63	Standpipes	1. Correct Installation 2. Maintenance
58.635	Fire Extinguishers	1. Proper Type 2. Location 3. Maintenance 4. Operational
58.64	Fire Alarms	1. Operation of System 2. Location of Pull Stations
58.65	Automatic Smoke Detection Systems	1. Correct Installation 2. Maintenance of Detectors
58.67	Smoke Barrier	1. Correct Installation 2. Maintenance
Ch. Comm 59—Hazardous Occupancies		
59.13	Type of Exits	1. Maintenance 2. Proper Exit Hardware
59.14	Number and Type of Exits	1. Maintenance 2. To Be Clear and Unobstructed
59.17	Enclosure of Stairways and Shafts	1. Maintenance of Enclosures
59.19	Illumination Levels	1. Proper Illumination
59.23	Fire Protection	1. Operation of System 2. Proper Type of Extinguisher 3. Location of Extinguisher 4. Extinguisher Operational 5. Water Supply 6. Obstruction of Sprinkler Heads 7. Location and Accessibility of Fire Department Connection 8. Maintenance of Systems
59.24	Fire Alarms	1. Operation and Testing 2. Location of Pull Stations
Ch. Comm 60—Child Day Care Facilities		
60.12	Doors	1. Joint Inspection Made
60.16	Electrical Work	1. Electrical Check List
60.19	Operating Features	1. Owner Responsibility
60.31	Exiting	1. Joint Inspection Made
60.32	Required Exit Width	1. Width to be Unobstructed
60.33	Passageways	1. Joint Inspection Made
60.34	Stair and Shaft Enclosure	1. Joint Inspection Made
60.35	Fire Extinguisher	1. Proper Type 2. Location 3. Maintenance 4. Operational
60.36	Fire Alarm System	1. Operation and Testing 2. Location of Pull Station

Rule Number	Topic of Rule	Subject of Investigation
60.38	Exit and Emergency Lighting	1. Joint Inspection Made
	Ch. Comm 61—Community-Based Residential Facilities	
61.10 (1) (h)	Construction, Building and Site	1. Maintenance
61.10 (3)	Smoke Separation	1. Maintenance
61.12	Exiting and Doors	1. To be Clear and Unobstructed
		2. Maintenance
61.14	Smoke Detection	1. Correct Installation
		2. Maintenance of Detectors
61.18 (4)	Ramp Requirements	1. Maintenance
61.20	Fire Extinguisher	1. Proper Type
		2. Location
		3. Maintenance
		4. Operational
61.24	Heating and Ventilating	1. Maintenance
61.25	Electrical	1. Electrical Check List
	Ch. Comm 62—Subch. I—Open Parking Structures	
62.26	Number, Location and Type of Pedestrian Exits	1. Maintenance
62.29	Illumination and Exit Lights	1. Maintenance of Illumination and Exit Lights
62.30	Fire Protection	1. Correct Installation of Standpipes
	Ch. Comm 62—Subch. III—Tents	
62.46	Fire Hazards	1. Elimination of Fire Hazard
62.47	Exits	1. Maintenance
62.49	Electrical Installation	1. Proper Installation
62.50	Fire Extinguishing Equipment	1. Proper Type
		2. Location
		3. Maintenance
		4. Operational
62.51	Illumination, Exit Lights and Signs	1. Maintenance of Illumination
	Ch. Comm 62—Subch. V—Assembly Seating Facilities	
62.72	Inspection and Maintenance	1. Proper Maintenance
		2. Conformance With Rules
62.75	Means of Egress	1. Maintenance
		2. To Be Clear and Unobstructed
62.80	Illumination and Emergency Lighting	1. Proper Illumination
62.81	Fire Prevention	1. Maintenance
	Ch. Comm 62—Subch. VII—Pedestrian Access Structures Connecting Buildings	
62.98	General Requirements Construction	1. Protection of Openings
		2. Maintenance
62.99	Exiting	1. Maintenance
		2. To Be Clear and Unobstructed
	Ch. Comm 64—HVAC	
64.08	Exhaust Ventilation System	1. Maintenance
64.09	Combustion Air Intakes	1. Maintenance
64.16	Air Cleansing Devices	1. Maintenance
64.19	Location of Outside Ventilating Air Intakes and Exhausts for Mechanical Ventilating Systems	1. Maintenance
64.21	Location of Equipment	1. Proper Equipment
		2. Maintenance
64.22 (5) (c)	Space Heaters	1. Use of Unvented Heaters Prohibited in Some Locations
64.22 (7)	Fireplaces and Fireplace Stoves	1. Proper Installation
		2. Maintenance
		3. Operation and Testing

Rule Number	Topic of Rule	Subject of Investigation
64.23 (5)	Piping	1. Installation 2. Maintenance
64.45	Chimneys, Smoke Stacks, Gas Vents, Mechanical Draft and Venting Devices	1. Maintenance
64.46	Masonry Chimneys	1. Maintenance
64.47	Metal Smokestacks	1. Maintenance
64.48	Factory-Built Chimneys and Gas Vents	1. Maintenance
64.49	Gas Vent	1. Maintenance
64.50	Chimney and Vent Connectors	1. Maintenance
64.51 (4)	Fire Protection	1. Correct Equipment 2. Proper Installation 3. Proper Clearances and Protection
64.52 (1)	Maintenance	1. Inspection of Chimney After Fire Before Reuse
64.61 (2)	Repair Areas	1. Maintenance
64.62 (2)	Vehicle Service Buildings	1. Maintenance
64.63 (2)	Garages	1. Maintenance
64.67 (5) (e), (f) and (g)	Kitchens	1. Maintenance
64.67 (6)	Automatic Suppression Systems	1. Correct System 2. Proper Installation 3. Maintenance and Operational



Chapters Comm 50-64

APPENDIX C

The 1989 Wis. Act 335 requires the department to establish rules for public buildings such that adequate space is provided within or adjacent to buildings for the separation, temporary storage and collection of recyclable materials likely to be generated by the occupants of the building.

When verified amounts of previously generated recyclable materials are available, the following may be used to determine adequate space for the separation, temporary storage and collection of recyclable materials:

One cubic yard should be allocated for each 200 pounds of

newspaper and mixed paper.

One cubic yard should be allocated for each 80 pounds of mixed or commingled recyclable materials.

The guidelines in the following table are provided for determining adequate space allocation when verified amounts of previously generated recyclable materials are not available. These guidelines are based on accumulation of recyclable materials likely to be generated by the building occupants for one week and one month, respectively.

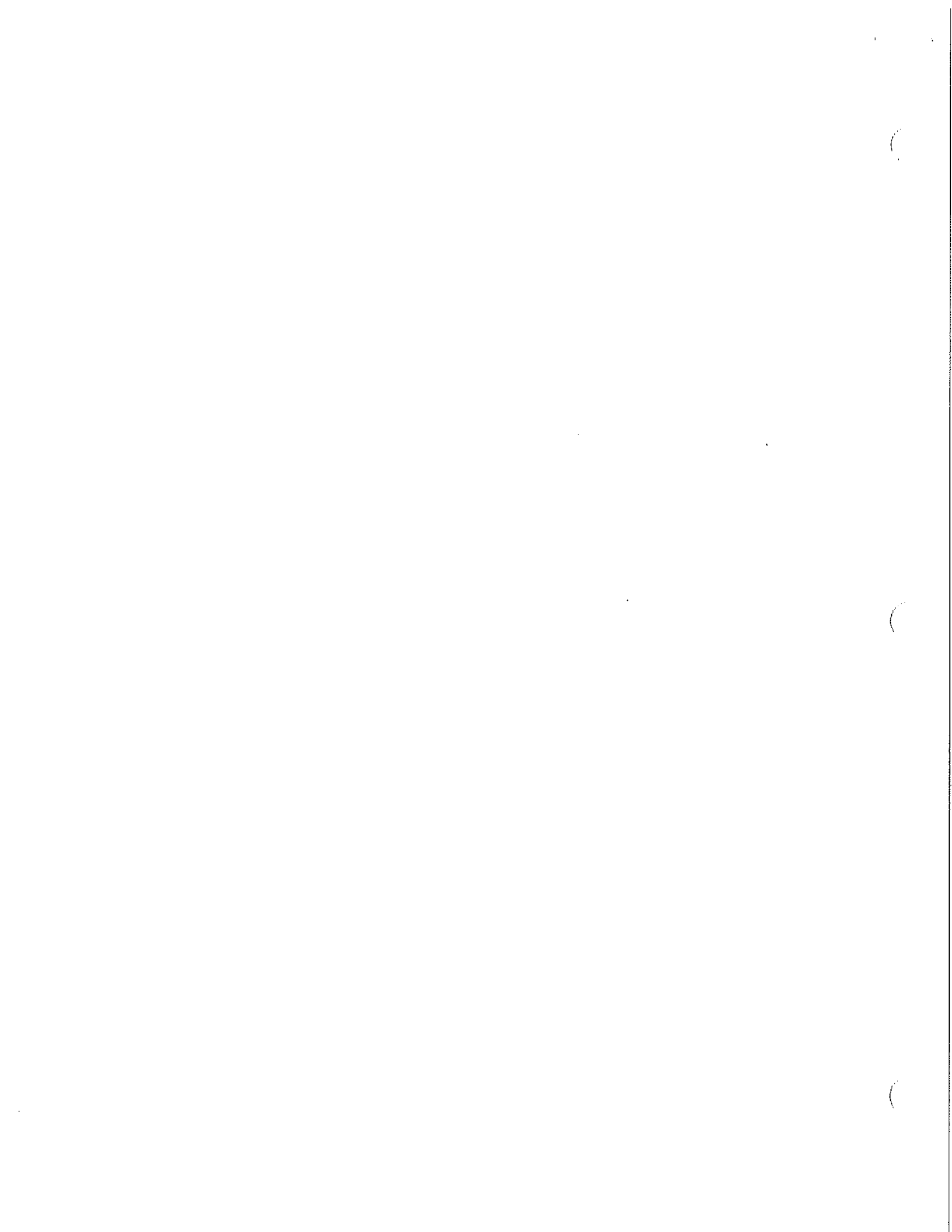
Guidelines for Recommended Space Allocation by Type of Building Occupancy*

Type of Building Occupancy	Space Allocation (cu. ft./1,000 sq. ft. floor area)	
	One Week	One Month
Assembly Hall, Theater	2.2	10.0
Child Day Care		
with meals served	4.5	20.0
without meals served	3.0	12.0
Detention and correctional	13.5	60.0
Garage		
Storage	0	0
Repair	b	b
Health Care		
Hospital	13.85	60.0
Clinic, without meals served	8.0	36.0
Nursing/Rest Home	4.5	20.0
Hotel, Motel		
without meals served	3.5	15.0
Industrial	b	b
Library	2.2	10.0
Mercantile		
Department Store, Shopping Mall	9.0	40.0
Grocery	18.0	80.0
Museum, Art Gallery	2.2	10.0
Office	7.0	30.0
Residential, multi-family dwelling	9.0	40.0
Restaurant or Food Service	c	c
School, Places of Instruction	3.0	12.0
Warehouse	b	b

* This information is to be used only as a guide in determining space allocation. Space allocation may differ from the listed value when using verified amounts of previously generated recyclable materials.

^b Varies with type of activity.

^c Varies with number of meals served and type of meal service.



Chapters Comm 50-64

INDEX

See also first page of each chapter for listing of section headings.

- A**
- Comm Section No(s).
- ACADEMIES** ch. Comm 56
- ACCESS:**
- Attics 51.02(18)(a)
 - Buildings – fire department 54.01(5), 57.02(3)
 - Roofs 51.02(18)(b)
 - Windowless floor levels – fire department 52.02
- ACCESSIBILITY FOR PHYSICALLY DISABLED:** .. 52.04
- Access to primary floor 52.04(4)(a)
 - Additions 52.04(6)
 - Alterations 52.04(6)
 - Corridors 52.04(9)
 - Definitions 52.04(2)
 - Doors 52.04(9)
 - Drinking fountains 52.04(11)
 - Interior circulation 52.04(4)(b)
 - Multi-use buildings 52.04(5)
 - New construction 52.04(4)
 - Parking 52.04(3)(a)
 - Platforms 52.04(3)(d), 52.04(9)(e)
 - Ramps 52.04(3)(b), 52.04(3)(d), 52.04(7)
 - Site requirements 52.04(3)
- ACP TABLES** 63.15, Fig 63.15
- Selecting 63.13(1)
- ACTIVITY METHOD** 63.49
- ADDITIONS:**
- Accessibility for the disabled 52.04(6)
 - Application 50.03, 63.001(3)
 - Assembly halls 55.02(2m)(c)4
 - Design 50.07
 - Sprinkler systems 52.01(1)(a), 52.011(5)
- ADJOINING BUILDINGS:**
- Excavation protection 53.26
 - Parapets 51.02(12)
- ADMINISTRATION AND ENFORCEMENT**
(Ch. Comm 50):
- Additions 50.03, 50.07, 52.04(6), 63.001(3)(a)
 - Alterations 50.03, 50.07, 50.12, 63.001(3)(b)
 - Appeals 50.24
 - Application of code 50.03, 50.04
 - Approval by certified city inspector 50.21
 - Approval of materials, equipment, devices testing laboratories 50.19
 - Approval of plans and specifications 50.12, 63.01, 64.02
 - Approval, revocation of 50.16
 - Certificate of occupancy, local requirement 50.06
 - Change of use 50.03, 52.04, 63.001
 - Changes to plans and specifications 50.12(6)
 - Design 50.07, 50.08
 - Design responsibilities 50.12(3)(a)
 - Enforcement 50.21(6), 50.23
 - Evidence of plan approval 50.15
 - Existing buildings 50.05
 - Expiration of plan approval 50.17
 - Fees 50.20, ch. Comm 2a,b,c,d.
 - First class city examination and approval 50.21
 - Footings and foundation approval 50.13
 - Local regulations 50.06
 - Penalties 50.26
 - Permission to start construction 50.14
 - Petition for variance 50.25
 - Plans prepared outside Wisconsin 50.08
 - Scope of code 50.02, 50.04
 - Tests and test reports 50.19, 51.044, 64.20
- AF (See area factors)**
- AGRICULTURAL BUILDINGS:**
- Exemption 50.04
 - Greenhouses 62.90–62.96
- AIR CONDITIONING:**
- Controls 63.26, 63.27
 - Design criteria 63.24, 64.01
 - Equipment Efficiencies 63.20
- AIR INTAKES:**
- Combustion equipment (Solid and liquidfuels) 64.09
 - Fresh air 64.19
 - Location 64.07(1)
 - Projection booths, ventilation 55.44
- AIR LEAKAGE** 63.11
- AIRPLANE HANGARS:**
- Plan review exemption 50.12(1)(f)
- ALARM SYSTEMS:**
- Fire alarms 51.24
 - High rise buildings 52.01
 - Smoke detectors 51.245
- ALLEY:**
- Definition 51.01(2)
 - Exiting 52.26
- ALLOWABLE AREAS AND HEIGHT OF BUILDINGS** 51.02, 51.03, 52.013, 54.01, 57.02, 59.12, 62.24, 62.43, 62.94
- ALLOWABLE STRESSES:**
- Crane 53.14
 - Masonry-empirical method 53.322(1)
- ALTERATION** 50.03(4), 51.01 (2e), 51.01 (105m), 63.001(3)(b)
- ALTERATIONS:**
- Accessibility 52.04
 - Code application 50.03
 - Design 50.07
 - Plan review 50.12
- ALUMINUM CONSTRUCTION** 53.54
- AMUSEMENT FACILITY** 51.01 (2m)
- AMUSEMENT PARK:**
- Amusement structures (Refer to ch. Comm 34)
- ANCHORAGE, ANCHORS:**
- Bolts 53.34
 - Concrete slabs on masonry (Restrained) 53.322
 - Masonry, general 53.316, 53.322, 53.323, 53.34
 - Masonry, veneer 53.322(6), 53.36(5)

Steel floor joists 53.52
 Timber fasteners 53.322, 53.61, 53.63
 Uplift and suction forces 53.12
 Walls and partitions, intersecting 53.63
 Wood fasteners 53.61
 Wood floor framing to masonry 53.322, 53.323
 Wood floor joists or beams on masonry 53.322, 53.323
 Wood framing around openings 53.63
 Wood headers 53.63
 Wood joist anchors 53.63
 Wood nailing schedule 53.63
 Wood partitions 53.63
 Wood sill anchors 53.63
 Wood trusses 53.12, 53.62

ANTENNA 62.35, 62.41
 Plan review 50.12(1)(i)

APARTMENT BUILDINGS ch. Comm 57

APPEALS 50.24

APPROVED, Definition 51.01(3)

APPROVED DIVERSIFIED TESTS:
 Definition 51.01 (3a)
 Foam plastics 51.06

ARCHITECT:
 Design 50.07, 50.08
 Plan submittal 50.12
 Supervision 50.10

AREA:
 Conditioned floor area .. 63.001 (3), 63.25 (2), 63.27 (2)(a),
 63.47
 Definition 63.05 (6)
 Daylit area 63.45
 Definition 63.05 (13)
 Exterior roof or ceiling area .. 63.05 (21), 63.05 (16), 63.05
 (22), 63.05 (32)
 Exterior wall area 63.05 (80)
 Definition 63.05 (23)
 Fenestration area, Definition 63.05 (25)
 Gross, definition 51.01(4)
 Gross exterior wall area 63.05 (33), 63.18 (3)
 Definition 63.05 (27)
 Gross floor area 63.18 (3)
 Definition 63.03 (28)
 Gross floor area over outside or
 Unconditioned spaces 63.18 (3)
 Definition 63.05 (29)
 Gross lighted area, Definition 63.05 (30)
 Gross roof area, Definition 63.05 (31)
 Gross exterior roof area 63.18 (3)
 Definition 63.05 (32)
 Listed space area, Definition 63.05 (39)
 Net, definition 51.01(5)
 Opaque areas, Definition 63.05 (48)
 Support area, Definition 63.05 (62)
 Window area, Definition 63.05 (79)

AREA CATEGORY METHOD 63.48

AREA FACTORS 63.49

AREAS:
 Allowable areas 54.01, 57.02, 59.12, 62.24, 62.43, 62.94
 Attic areas 51.02(19)
 Automatic sprinklers 52.013
 Draftstopping-floor/ceiling assemblies 53.63(2)
 Increase in areas 54.01, 57.02, 59.12
 Unlimited areas 54.01
 Thermal envelope components 63.18(3)

AREAWAY:
 Definition 51.01(5a)
 Habitable rooms below grade 57.11

ARENA, Horse ch. Comm 54 or 55

ASPHALT, Roof coverings 51.03-A, 51.05

ASSEMBLY HALLS:
 100 persons or less ch. Comm 54
 More than 100 persons ch. Comm 55

ASSEMBLY SEATING FACILITIES 62.70-62.81

ATRIUM:
 Definition 51.01(5b)
 General requirements 52.07

ATTIC:
 Access 51.02, 57.19
 Compartmentalization 51.02(18)
 Definition 51.01(6)

AUDITORIUMS (See ASSEMBLY HALLS)

AUTOMATIC, Definition 51.01(7), 63.05(2)

AUTOMATIC FIRE SPRINKLER SYSTEM:
 Definition 51.01(7a)
 Health care facilities 58.24, 58.25, 58.29
 High rise buildings 52.01
 Housing for the elderly 57.016(2)
 Low rise buildings 52.011, 52.012, 52.013
 School basements 56.03
 Specifications 51.23

AUTOMATIC FIRE SUPPRESSION SYSTEM
 Definition 51.01(7b)

AUTOMATIC TIME SWITCH CONTROL DEVICE,
 Definition 63.05 (2)

B

BALANCING
 Air system 64.53 (2)
 Hydronic system 64.53 (2)

BALCONY:
 Definitions 51.01(8), 51.01(9)
 Exterior balcony, as exit 54.03, 57.05(12)
 Fire escapes 51.20

BALLAST
 Electronic A63.45
 Magnetic A63.45
 Tandem wiring 63.53

BARRIER-FREE DESIGN 52.04

BASEMENT:
 Definition 51.01(10)
 Fire department access 52.02(2)
 Habitable room below grade 57.11
 Schools 56.03
 Windowless floor levels 52.012(1)

BATHROOM (See TOILETS, TOILET ROOMS, REST
 ROOMS, SANITARY FACILITIES)

BEAMS (Also see GIRDERS):
 Concrete design 53.40
 Fire cuts 53.63
 Fire protective and fire-resistant
 requirements 51.03, 51.043, 51.045
 Plywood beams 53.61
 Reinforced concrete 53.40

- Reinforced masonry 53.323
 Steel 53.50
 Structural, glue laminated 53.61
 Timber, heavy 53.61
 Wood 53.61
- BEARING:
 Soil capacity 53.21
 Wood beams and girders 53.34, 53.63
 Wood columns 53.60
- BEARING WALL, Definition 51.01(11)
- BED AND BREAKFAST ESTABLISHMENT:
 Code exemption 50.04
 Definition 51.01(11a)
- BELOW-GRADE WALLS 63.15 (6)
- BI-LEVEL ILLUMINATION 63.50 (2)
- BLEACHERS, Temporary seats 62.70-62.81
- BLOCKS, CONCRETE MASONRY UNITS 53.311
- BOILERS 63.20 (4), 64.22 (10)
- BOLTS (See ANCHORAGE AND ANCHORS)
- BOWLING ALLEYS ch. Comm 54 or 55
- BRACING:
 Exterior stud walls 53.63
 Masonry walls, lateral 53.322
 Smokestacks 64.47
- BRIDGING:
 Steel joists 53.50, 53.52
 Wood joists 53.63
- BUILDING:
 Allowable areas and heights 51.02, 51.03, 52.013, 54.01, 56.01, 57.02, 59.12, 62.24, 62.43, 62.94
 Alterations 50.03, 50.07
 Capacity 54.05, 55.06, 57.04, 60.11
 Change of use 50.03, 52.04, 63.001
 Classes of construction 51.03
 Definition 51.01 (12)
 Existing 50.05
 Locations 51.02(7),(12), 51.03, 55.02(2m), 62.22
 Maintenance 52.22, 52.64, 55.50, 61.21
 Pole 51.03(6)
 Temporary 50.04
- BUILDING ENVELOPE 63.10 - 63.18
 Definition 63.05 (4)
 Component standards 63.15
 Gross area of components 63.18 (3)
 Compliance methods 63.14
 System standards 63.16
 Energy cost budget 63.70
 Required documentation 50.12 (4)(b)
- BUILDING PLAN APPROVAL 50.12
- BUTTRESS, Definition 51.01(14)
- C**
- C (See thermal conductance)
- CAISSONS 53.24
- CALCULATIONS:
 Energy conservation 50.12(4)(a)
 HVAC 50.12(4)(c)
- Structural 50.12(4)(b)
- CANOPIES:
 Lighting 63.43 (2)
 Service stations 59.11
 Structural 53.11(4)
- CAPACITY (See BUILDING CAPACITY)
- CAVITY WALL, Definition 51.01(15)
- CEILING PROTECTION:
 Day care centers 60.30
 Definition 51.01(16)
 Residential occupancies 57.01(3)
- CEILINGS 51.03, 51.045
- CELLAR (See BASEMENT)
- CEMENT (See PORTLAND CEMENT)
- CERTIFICATE OF OCCUPANCY 50.06
- CERTIFIED MUNICIPAL APPROVALS 50.21
- CERTIFIED INSPECTOR, Definition 51.01(16a)
- CFA (See conditional floor area)
- CHANGE OF OCCUPANCY:
 (Change of use) 50.03, 52.04, 63.001
- CHIMNEYS 64.45, 64.46, 64.48, 64.50
- CHURCHES (See ASSEMBLY HALLS)
- CIRCULATION, ACCESSIBILITY 52.04
- CLASSIFICATION OF BUILDINGS:
 Construction classification 51.03
 Occupancy classifications See OCCUPANCY CHAPTERS chs. Comm 54, 55, 56, 57, 58, 59, 60, 61, 62
- CLASSROOMS:
 Mobile training units 56.40
 Relocatable 56.30
- CLEANLINESS 52.23
- CLEARANCE LIMITATIONS:
 Fire Protection 64.51
 Headroom 51.164
 Open parking structures 62.25
- CLERESTORIES 63.12 (2)(c)
- CLIMATE DATA 63.23 (1)
- CLOSING DEVICE:
 Definition 51.01(17)
 Residential occupancies 57.06(2)
- COLLEGES AND UNIVERSITIES ch. Comm 56
- COLUMNS:
 Definition 51.01(17n)
 Fire protection requirements 51.02, 51.03, 51.045
 Footings supporting 53.11
 Heavy timber 51.03
 Masonry 53.322
 Reinforced concrete 53.40
 Structural steel 53.50
 Wood 53.61, 53.63

COMBINATION SPACE AND WATER HEATING SYSTEMS 63.20 (4), 64.22 (10)

COMBUSTIBLE:
 Clearance to 64.51
 Construction, definition 51.01(18)
 Material, definition 51.01(19)
 Material, storage of 60.19

COMBUSTION AIR 64.09

COMFORT 63.05 (5), 63.25

COMFORT COOLING, Definition 63.05 (5)

COMFORT HEATING, Definition 63.05 (5)

COMMERCIAL MOTOR VEHICLE
 Definition 51.01(19a)

COMMISSIONING 64.53

COMMUNITY-BASED RESIDENTIAL FACILITIES (CBRF) ch. Comm 57 or 61
 Definition 51.01(19b)
 Exemption 50.04

COMPLETE BUILDING METHOD 63.47

COMPLIANCE FORMS 50.12 (4)(b)

COMPONENT STANDARDS METHOD 63.14, 63.15

COMPOSITE WALLS 53.322

COMPOSITION ROOFING 51.05

COMPUTER ROOMS 63.21 (2)(b)

CONCRETE: 53.40-53.42
 Types of 51.045

CONCRETE BLOCKS 53.311

CONCRETE CONSTRUCTION:
 Aggregate 53.40, 53.42
 Basement walls 53.322, 53.40
 Beams 53.40
 Block 53.311
 Columns 53.40
 Concrete 53.40-53.42
 Concrete, types of 51.045
 Erection 53.40
 Fire-resistance materials 51.043-51.045
 Fire-resistance ratings 51.043
 Gypsum concrete 53.41
 Lateral support 53.322, 53.40
 Materials 53.40
 Precast, Prestressed, Pretensioned 53.40
 Piers 53.322, 53.40
 Post-tensioned 53.40
 Protection against freezing 53.33
 Reinforced 53.40
 Stone 53.311, 53.40-53.42
 Tests 53.40
 Types 53.045
 Water 53.315
 Vermiculite 53.42
 Working stresses 53.311, 53.312, 53.40

CONCRETE FLOORS 63.15 (5)

CONDENSATION 63.11 (4)

CONDITIONED FLOOR AREA, Definition 63.05 (6)

CONDITIONED SPACE, Definition 63.05 (7)

CONDOMINIUMS ch. Comm 57

CONNECTED LIGHTING POWER 63.45

CONNECTORS, CHIMNEY & VENTS 64.50

CONSERVATION OF ENERGY ch. Comm 63

CONSTRUCTION:
 Aluminum 53.54
 Classes 51.03
 Concrete 53.40
 Definition 51.01(21)
 Masonry 53.32, 53.322, 53.323, 53.33, 53.34, 53.35
 Separation of classes 51.02(20)
 Stage separation 55.21
 Steel 53.50
 Temporary 50.04
 Types 51.03
 Wood framing 53.60, 53.61, 53.62, 53.63

CONVALESCENT HOMES ch. Comm 57

CONVENTS ch. Comm 57

COOLED SPACE,
 Definition 63.05 (8)

CORBELING MASONRY 53.34

CORRECTIONAL FACILITIES ch. Comm 58 subch. II

CORRIDOR, Definition 51.01(22)

CORRIDORS:
 Definition 51.01(22a)
 Required exits - fire ratings 51.03

COURT:
 Definition 51.01(23)
 Inner, definition 51.01(24)
 Inner lot line, definition 51.01(25)
 Outer, definition 51.01(26)
 Outer lot line, definition 51.01(27)
 Sizes 52.05

COURT WALLS, REQUIRED FIRE-RESISTIVE 51.03

CURB, CUT FOR BARRIER-FREE ACCESS 52.04(3)

CURTAIN, PROSCENIUM 55.23

CURTAIN WALL,
 Definition 51.01(28)

D

DAMPERS
 Combustion air 64.09 (2)
 Exhaust and intake 64.19 (5), 64.67 (5)(i)

DAMPERS AND SHUTTERS, FIRE 51.0485

DANCE HALLS ch. Comm 54 or 55

DAY CARE CENTERS ch. Comm 60

DAYLIT AREA 63.50 (3), A63.05 (13)
 Definition 63.05 (13)

- DAYLIGHTING CONTROL 63.45 (2), 63.50 (3)
 Definition 63.05 (9)
- DEAD LOADS 53.10
- DEADBAND 63.26 (2)(d)
 Definition 63.05 (10)
- DECAY PREVENTION 53.63
- DECORATIVE FEATURES:
 Assembly halls 55.18, 55.19
 Exterior projections 51.03
 Fire protection requirements 51.02(15)
 Interior finishes 51.06
- DEFINITIONS:
 Certain words and topics 51.01, 63.05
 Occupancies, scopes .. 54.001, 55.01, 56.001, 56.30, 56.40,
 56.50, 57.001, 58.001, 58.40, 59.10, 60.01, 61.001, 62.20,
 62.35, 62.42, 62.52, 62.70, 62.90, 62.97
 Types of construction 51.03
- DEGREE DAY, Definition 63.05 (11)
- DEHUMIDIFICATION CONTROLS 63.27
- DEPARTMENT, Definition 51.01(29)
- DESIGN CONDITIONS 63.23
- DESIGN AND SUPERVISION OF
 CONSTRUCTION 50.07, 50.10
- DETECTORS (See SMOKE DETECTION)
- DETENTION AND CORRECTIONAL
 FACILITIES ch. Comm 58 subch. II
- DIAPHRAGMS, PLYWOOD 53.61
- DIRECT VENT SEALED COMBUSTION CHAMBER
 APPLIANCE:
 Boilers 64.21(2)
 Definition 51.01(29a)
 Furnaces 64.21(1)
 Water heaters 64.21(2)
- DISPLAY LIGHTING, Definition 63.05 (11)
- DISTANCE BETWEEN BUILDINGS 51.03
- DISTRIBUTION OF EXITS 51.151
- DIVISION WALL, Definition 51.01(30)
- DOORS 63.15 (2), 63.18 (1), 63.18 (2)(a) 3., A63.18
- DOORS AND DOOR ASSEMBLIES, RATED 51.047
- DORMITORIES ch. Comm 57
- DRAFT STOPS 53.63
- DRAWINGS (See ADMINISTRATION AND
 ENFORCEMENT)
- DRESSING ROOMS, STAGE 55.28
- DRINKING FOUNTAINS:
 Accessibility 52.04(11)
 Assembly halls 55.32
 CBRF's 61.19
 Correctional facilities 58.68
 Educational facilities 56.16
 Factories, offices, stores 54.12
 General requirements 52.60(4)
 Health care facilities 58.32
- Residential facilities 57.12
- DRY CLEANING .. 54.14(1)(c) (Also refer to ch. Comm 15)
- DUCT, Definition 51.01(31)
- DUCT FURNACE, Definition 51.01(32)
- DUCTS 64.31-64.40
 Duel duct systems 63.27 (2)(g)
 Insulation 63.29 (3)
 Kitchen exhaust 64.67
 Materials 64.34
 Sealing 64.34
 Underground 63.27
- DUMB WAITERS (Refer to ch. Comm 18)
- DWELLING UNITS 63.45 (3)(p), 63.42 (4)
- DWELLINGS:
 Apartments ch. Comm 57
 One and two-family units exempt 50.04
 (Also refer to Uniform Dwelling Code chs. Comm 20-25)
- E**
- EA (See effective aperture)
- EARTH PRESSURE:
 Piling 53.24
 Pole foundations 53.28
 Soil bearing capacity 53.21
- ECB (See energy cost budget)
- ECCENTRIC LOADS 53.11
- ECONOMIZERS 63.31
 Water economizers, definition 63.05 (15)
- EFFECTIVE APERTURE, Definition 63.05 (16)
- EFFICACY, Definition 63.05 (17)
- EFFICIENCIES 63.20, 63.21, A63.20
- ELECTRIC WELDING 53.53
- ELECTRICAL WORK:
 CBRF 61.25
 General Requirements 52.20
 Sprinklers 51.23(1)
 (See also Wis. Electrical Code ch. Comm 16)
- ELPA (See exterior lighting power allowance)
- ELEVATORS (Refer to ch. Comm 18)
- ELEVATOR SHAFTS (See VERTICAL OPENINGS)
- EMERGENCY LIGHTS 63.45 (3)(1)
- EMISSIVITY, Definition 63.05 (18)
- ENCLOSURE OF VERTICAL OPENINGS
 (See STAIRS AND STAIRWAYS and TYPES OF
 CONSTRUCTION)
- ENERGY CONSERVATION: (ch. Comm 63)
 HVAC Equipment and systems:
 Controls 63.26, 63.27, 63.28
 Cooling with outdoor air 63.31
 Equipment efficiencies 63.20
 Insulation 63.29
 Illumination and electrical systems:
 Controls 63.45, 63.50, 63.51
 Lighting 63.40-63.49
 Motors 63.32

Nondepletable energy sources:
 Documentation 63.61
 Solar, wind, geothermal, and others 63.60
 Scope and purpose:
 General 63.001
 Plans and specifications 63.01
 Purpose 63.002
 Systems analysis design:
 Annual energy consumption 63.70
 Documentation 63.72
 Simulation 63.71
 Thermal envelope
 Component standards 63.15
 System standards 63.16
 Calculations 63.18
 General requirements 63.11
 ENERGY COST BUDGET 63.70
 ENERGY RECOVERY (See heat recovery)
 ENGINEER:
 Design 50.07, 50.08
 Plan submittal 50.12
 Supervision 50.10
 EQUIPMENT, Definition 51.01(34)
 EQUIPMENT CONTROLS 63.22, 63.27 (3)
 EQUIVALENT THICKNESS, MASONRY 51.045
 EXCAVATIONS 53.20-53.28
 EXHAUST VENTILATION SYSTEMS: 64.08
 Definition 51.01(35)
 EXHIBITION BUILDINGS ch. Comm 54
 EXISTING, Definition 51.01(36)
 EXISTING BUILDINGS:
 Additions, alterations, repairs 50.03, 63.001
 Application of code 50.03
 Barrier-free environment 52.04
 General orders on (Refer to chs. Ind. 160-164)
 EXIT:
 Access, definition 51.01(36b)
 Aisles (See PASSAGEWAYS)
 Areas of hazards 51.167
 Capacity 51.15
 Court 52.05
 Court, definition 51.01(37)
 Definition 51.01(36a)
 Discharge grade, definition 51.01(38)
 Distribution 51.151
 Doors 51.15, 54.06, 55.10, 56.08, 57.06, 58.04, 58.49,
 59.13, 60.12, 61.12
 Doors, revolving, sliding 51.15(2), 54.06, 55.10
 Enclosures 51.02(14), 51.18
 Hardware 51.15(3)
 Horizontal 51.19
 Lights 51.15(5), 54.06, 55.11, 56.06, 57.10, 58.18, 58.57,
 59.14, 60.38, 62.29, 62.51
 Locking 51.15(3), 54.06(3), 58.20, 58.58
 Means of egress, definition 51.01(80a)
 Monumental stairs 54.08, 55.09
 Number required .. 54.02, 55.07, 56.06, 57.03, 58.05, 58.49,
 59.14, 60.11, 60.31, 61.12, 62.26, 62.47, 62.53, 62.75,
 62.95, 62.99
 Panic hardware 51.15(3)
 Ramps (See RAMPS)
 Rescue platforms 54.03, 57.05
 Signs 51.15(5), 63.45 (3)(n), 63.52

Sliding door glazed 57.06, 60.12
 Stairways 51.16
 Width 51.15, 54.04, 55.12, 56.07, 57.04, 58.12, 58.54, 59.15,
 60.32, 62.47
 Vertical, definition 51.01(39)
 EXPLOSIVES, Storage of (Refer to ch. Comm 7)
 EXPOSED EXTERIOR COLUMNS AND
 FRAMING 51.02(10)
 EXTERIOR ENVELOPE, Definition 63.05 (19)
 EXTERIOR LIGHTING
 Building facades 63.43 (2) (d)
 Canopy 63.43, (2) (b)
 Exempt 63.42
 Manufacturing 63.42 (1)
 Power allowance 63.43
 Soffits 63.43 (2) (b)
 What is covered 63.40
 EXTERIOR OPENINGS:
 Doors (See DOORS AND DOOR ASSEMBLIES)
 Ducts 64.19
 Exits 51.15, 51.20
 Fire protection 51.02 (4), 51.03
 Intakes 64.19
 Vents 64.19, 64.39, 64.40
 EXTERIOR ROOF OR CEILING,
 Definition 63.05 (20)
 EXTERIOR ROOF OR CEILING AREA,
 Definition 63.05 (21)
 EXTERIOR SHADE 63.50 (3) (b) 2.
 EXTERIOR STAIRWAYS 51.16, 51.20, 54.03
 EXTERIOR WALL:
 Construction 51.02(4), 51.03
 Definition 51.01(41), 63.05 (22)
 EXTERIOR WALL AREA,
 Definition 63.05 (23)

F

FACTORIES 54.001
 FACTORY, Definition 51.01(41a)
 FAMILY, Definition 51.01(42)
 FARM BUILDINGS, Exemption 50.04
 FARM OPERATION, Definition of 51.01(42a)
 FEE SCHEDULE (Refer to ch. Comm 2)
 FENESTRATION,
 Definition 63.05 (24)
 ACP tables 63.15
 U-value 63.18 (2) (b)
 FENESTRATION AREA, Definition 63.05 (25)
 FENESTRATION IN-FILL PANELS 51.02(4)
 FILLING STATIONS ch. Comm 54 or 59
 FINISHES (See INTERIOR FINISHES)
 FIRE:
 Alarms 51.24, 54.17, 56.19, 57.17, 58.64, 58.83, 59.24, 60.36
 Dampers 51.0485
 Doors 51.047

Escapes	51.20	FLOORS OVER UNCONDITIONED SPACE	63.15 (4), 63.18 (3) (b)
Exits (See EXIT)		FLUES	64.46
Extinguishers . . . 51.22, 54.145, 55.33(3), 56.18, 57.18, 58.28, 58.63(3), 59.23, 61.20, 62.50		FOAM PLASTICS	51.06
Protection requirements	51.02, 51.03	FOOTING (Also see FOUNDATIONS)	53.20
Ratings of material and assemblies	51.04	FOUNDATIONS:	
Sprinklers	51.23, 52.01, 52.011, 52.012, 52.013	Basement wall loads	53.11
Standpipes . . . 51.21, 54.15(2), 55.33(2), 56.20(2), 57.15(2), 58.28, 58.63(2), 59.23, 62.30		Caissons	53.24
Stopping	51.02 (24), 51.049	Concrete	53.40
Walls-division	51.02(13)	Design	53.11
FIRE DOOR, Definition	51.01(43)	Frost penetration	53.23
FIRE DOOR ASSEMBLY, Definition	51.01(44)	Masonry	53.322
FIRE DOOR CLOSING DEVICE, Definition	51.01(45)	Permit for	50.13, 50.14
FIRE RESISTANCE AND FIRE RESISTIVE MATERIAL, Definition	51.01(46)	Piers	53.322
FIRE RESISTANCE RATINGS:		Piles	53.24
Assemblies	51.045	Pole	53.28
Construction	51.03	Protection of adjoining property	53.26
Materials	51.045	Settlement	53.25
Standards and references	51.04	Soil bearing	53.21
Testing laboratories	51.044	Walls	51.02(4)
FIRE RESISTIVE:		Wood and timber, treated	51.02(4), 53.61, 53.64
Classification, definition	51.01(47)	FOYER, Definition	51.01(58)
Protection, definition	51.01(48)	FREESTANDING FREEZER AND COOLER: Definition	51.01(58a)
Protection, directly applied, definition	51.01(49)	Foam plastic	51.06
Rating, definition	51.01(50)	FREEZER WAREHOUSES	51.06
Standards	51.04	FRONT YARD, Definition	51.01(59)
FIRE RETARDANT:		FROST, DEPTH OF FOUNDATION FOR	53.23
Roof coverings, definition	51.01(51)	FUNERAL HOMES	ch. Comm 54 or 55
Treated wood, definition	51.01(52)	FURNACE:	
FIRE SUPPRESSION SYSTEM:		Definition	51.01(61)
Definition	51.01(7b)	Duct, definition	51.01(62)
General requirement	51.23	Requirements	63.20, 64.21, 64.22
High rise buildings	52.01(1)	FURRING:	51.03, 51.06
FIRE WINDOW ASSEMBLY		Fire division wall	51.02(13)
Definition	51.01(53)	Fire doors	51.047, 54.02
FIREBLOCKING:		Motion picture machine booths	55.43, 55.44
For wood frame construction	51.02 (24)	Stage smoke outlets	55.24
FIREPLACES AND FIREPLACE STOVES	58.24, 64.22		
FIRST FLOOR,		G	
Definition	51.01(54)	GALLERY	ch. Comm 56
FLAMEPROOFING REQUIRED	55.19, 62.45	GALVANIZED:	
FLAME-SPREAD CLASSIFICATION		Ducts	64.34
Definition	51.01(55)	Roofing	51.05
FLOODPLAIN, CONSTRUCTION WITHIN	50.07	Siding	51.03
FLOOR:		GARAGES:	
Definition	51.01(56a)	Mini-storage buildings	62.995
Finish	51.07, 52.57	Repair	ch. Comm 59
Fire resistance	51.03	Separations	51.08
First, determination	51.02(14)	Storage	ch. Comm 59
Level, definition	51.01(57a)	GENERAL LIGHTING, Definition	63.05 (26)
Loads	53.10, 53.11, 53.13	GLA (see gross lighted area)	
Mezzanine, definition	51.01(82)	GLASS:	
Pits, in garage	59.11	Block assemblies	51.048
Plywood	53.61	Labeling	51.048
Posting loads	54.17	Sizes	51.03, 51.048
Protection for stoves, water heaters	64.51	Wired	51.048
Trap door, stage	55.22		

GLAZING, SAFETY 51.14

GRADE:
 At building, definition 51.01(63)
 Exit discharge grade, definition 51.01(64)
 Lumber 53.61
 Plywood 53.61

GRAIN ELEVATORS ch. Comm 54

GRANDSTANDS 62.70-62.81

GRAVITY EXHAUST VENTILATION
 Definition 51.01(65)

GRAVITY SIPHON-TYPE VENTILATOR 64.08

GREENHOUSE 62.90-62.96

GROSS AREA, Definition 51.01(66)

GROSS EXTERIOR WALL AREA, Definition ... 63.05 (27)

GROSS FLOOR AREA, Definition 63.05 (28)

GROSS FLOOR AREA OVER OUTSIDE OR UNCONDITIONED SPACES, Definition 63.05 (29)

GROSS LIGHTED AREA 63.49 (5)
 Definition 63.05 (30)

GROSS ROOF AREA, Definition 63.05 (31)

GROSS EXTERIOR ROOF AREA, Definition ... 63.05 (32)

GROSS EXTERIOR WALL AREA, Definition ... 63.05 (33)

GROUND FLOOR:
 Definition 51.01(67)
 Number of stories 51.02(14)

GUARD TOWERS 58.67

GUARDRAILS: 51.162
 Grandstands 62.77
 Parking structures 62.28

GYMNASIUMS: ch. Comm 54 or 55
 Schools 56.02(5)

GYPSUM:
 Concrete 53.41
 Fire resistance ratings 51.045
 Reinforced 53.41

H

HABITABLE ROOM:
 Definition 51.01(67a), 61.01
 Floors below grade 57.11

HANDICAP (See ACCESSIBILITY FOR PHYSICALLY DISABLED)

HANDRAILS:
 Fire escapes 51.20
 Ramps, accessibility 52.04
 Stairways 51.161

HANGARS, AIRPLANE: ch. Comm 59
 Plan review exemption 50.12(1)

HAZARDOUS OCCUPANCIES: ch. Comm 59
 Construction 59.11
 Exiting 59.13-59.19
 Fire detection and suppression 59.23-59.24
 Height and area limitations 59.12
 Isolation of hazards 51.08 (2)

Occupancy separations 51.08
 Sanitary facilities 59.20

HAZARDOUS PIPING:
 Definition 51.01(68)
 Plenum 64.41

HAZARDS, ISOLATION OF 51.08 (2), 58.24

HC (See wall heat capacity)

HEADROOM 51.164, 62.25

HEALTH CARE FACILITIES: ch. Comm 58 subch. I
 Automatic sprinklers 58.24, 58.25, 58.29
 Class of construction 58.01
 Corridor wall construction 58.31
 Detention, alarm and communication systems 58.27
 General requirements 58.01
 Separation from other occupancies 58.02
 Smoke barriers 58.30

HEAT CAPACITY 63.15 (3), A63.15 (3) (b)
 Definition 63.05 (34)

HEAT PUMP AUXILIARY HEAT 63.22

HEAT RECOVERY 64.56 (3)

HEAT TRAPS Table 63.29-1

HEATED SIDEWALK, PROHIBITED 63.19

HEATED SPACE, Definition 63.05 (25)

HEATING SYSTEM, Definition 51.01(69)

HEATING, VENTILATING AND AIR CONDITIONING: ch. Comm 64

HEATING, VENTILATING AND AIR CONDITIONING SYSTEM, Definition 63.05 (36)
 Air cleansing devices 64.16
 Air movement and distribution 64.06
 Air velocities 64.31
 Automatic controls 64.17
 Chimneys, factory built 64.48
 Chimneys, masonry 64.46
 Combustion air intakes 64.09
 Contamination of air 64.18
 Dampers and damper controls 51.0485, 64.09
 Design 50.07, 50.08
 Duct connectors 64.35
 Duct construction 64.34
 Duct design 64.31
 Duct use 64.32
 Equipment installations 64.21
 Equipment ratings safety controls 64.20
 Exhaust ventilation system 64.08
 Fans and blowers 64.44
 Fire dampers and fire doors 51.0485
 Gas vents 64.50
 Gravity ventilation ducts 64.38
 Heat loss and capacity 64.03
 Inside design temperatures and ventilation 64.05
 Insulation 64.37
 Location of air intakes or exhausts 64.19
 Mechanical ventilation systems 64.06
 Natural ventilation systems 64.07
 Occupancy requirements 64.54-64.68
 Outside temperature design conditions 64.04
 Piping 64.23
 Plan submission 50.12
 Plenums 64.41
 Relief vents 64.40
 Smoke pipes 64.49
 Smokestacks, metal 64.47

- Solid fuel burning 64.21
 Special equipment requirements 64.22
 Tempered air requirements 64.13
 Tempered outside air requirements 64.14
 Underground duct 64.33
 Ventilation discharge 64.39
 Vertical shafts 64.36
- HEAVY TIMBER CONSTRUCTION 51.03(4)
- HEIGHT:
 Automatic sprinklers 51.02(21), 52.01
 Chimneys 64.45
 Classifications of construction 51.03
 Definition 51.01(70)
 Masonry walls 53.322
 Parapet walls 51.02(12), 53.322
 Towers, spires, poles 53.61, 62.35
 Windloads 53.12
- HOLLOW BONDED WALL, Definition 51.01(71)
- HOLLOW MASONRY:
 Units 53.311
 Walls 53.321, 53.322, 53.34
- HOODS, KITCHEN EXHAUST 64.67
- HORIZONTAL EXITS 51.19
- HORSE ARENA ch. Comm 54 or 55
- HOSE:
 Sprinklers 51.23
 Standpipes 51.21
- HOSPITALS: ch. Comm 58 subch. I
 Definition 51.01(71a)
- HOTELS ch. Comm 57
- HUMIDITY ... 53.05 (5), 63.05 (37), 63.25 (1), 63.27 (2) (c),
 63.28
- HUMIDISTAT, Definition 63.05 (37)
- HVAC (See heating, ventilating and air conditioning)
- HVAC
 Controls/Deadband 63.26 (2) (d)
 Dehumidification 63.27
 Humidity control 63.28
 Off-hour isolation 63.27 (3)
 Shut-off dampers 64.19 (5)
- HVAC EQUIPMENT
 Field assembled 63.21
 Minimum efficiencies 63.20
 Mixed manufacturers 63.21
 Multiple functions 63.20 (4), (5), (6)
 Part-load performance 63.20 (3)
 Scope 63.20
 Sizing 63.23
- HVAC SYSTEMS
 Balancing 64.53
 Dual duct 63.27 (2)(g)
 Sizing 63.23
 Testing 64.53 (1), (4)
- I**
- IN-FILL PANELS, FENESTRATION 51.02(4)
- INCREASE IN AREAS ALLOWED 54.01, 57.01, 59.12
- INDEPENDENT SYSTEMS 63.26 (2)
- INDIRECTLY CONDITIONED SPACE,
 Definition 63.05 (38)
- INFILTRATION 63.11, 64.03
- INNER LOT LINE COURT, Definition 51.01(73)
- INSPECTIONS: 50.18
 Public school maintenance 56.21
- INSULATION: 63.17
 Ducts 63.29, 64.37
 Linings, duct 64.36
 Pipe coverings 63.29, 64.23
 Slab, perimeter 63.15(5)
 Thermal performance 63.14
- INTAKE, OUTSIDE AIR, Definition 51.01(74)
- INTERIOR BALCONY (See MEZZANINE)
 Definition 51.01(75)
- INTERIOR DRAPES (See interior shading)
- INTERIOR FINISHES:
 Application of 51.07
 Definition 51.01(75a)
 Flame spread 51.07, 58.26
 Floor finish, toilet rooms 52.57
 Smoke developed 51.07, 58.26
 Walls, toilet rooms 52.58
- INTERIOR LIGHTING 63.44 – 63.53
 Exempt 63.45 (3)
 What is covered 63.45
- INTERIOR LIGHTING POWER 63.45
- INTERIOR LIGHTING POWER ALLOWANCE 63.46
- INTERIOR PARTITIONS 51.03
- INTERIOR SHADING 63.15 (2) (b), 63.18 (4)
- INTERIOR STAIRWAYS, ENCLOSED 51.18
- ISOLATION OF HAZARDS 51.08 (2), 58.24
- J**
- JAILS ch. Comm 58 subch. II
- JOISTS:
 Concrete 53.40
 Decay resistance 53.63
 Fire cuts 53.63
 Fire resistance ratings 51.045
 Fire stopping 53.63
 Floor framing 53.63
 Steel 53.50, 53.52
 Wood 53.60–53.63L
- LABELS:
 Exit door bolts 51.15(3)
 Fire doors 51.047
 Roofing 51.05

Safety glazing 51.14
 Windows 51.048

LADDERS, ACCESS TO ATTIC OR ROOF 51.02(18)

LAMINATED MATERIALS 53.60

LATERAL BRACING 53.50

LAUNDRY ROOMS:
 Sprinklers 52.011

LAVATORIES 52.60(3)

LIBRARIES ch. Comm 56

LIGHT:
 Exit signs ... 51.15, 54.06, 55.11, 56.06, 57.10, 58.18, 58.57,
 59.14, 60.38, 62.29, 62.51
 Occupancies 54.11, 55.30, 56.17, 58.17, 58.575, 59.19,
 60.17, 62.60
 Lighting power budgets 63.43-63.49

LIGHT TRANSMITTING PLASTICS 51.065

LIGHTING
 Default wattages Tables A63.45 1-6
 Efficacy 63.42 (6)
 Definition 63.05 (17)
 Multi-use facility 63.45 (1), Table 63.49 note f
 Multifunction rooms 63.45 (1)
 Scope 63.40
 Simultaneous activities 63.45 (1)
 Trade-offs 63.41

LIGHTING CONTROLS
 Daylight 63.45 (2), 63.50 (3)
 Eligible 63.45 (2), 63.50
 Exterior 63.50 (6)
 Lumen maintenance, definition 63.05 (40)

LIGHTING POWER ALLOWANCE
 Exterior 63.43
 Interior 63.46 - 63.49
 Complete building method 63.47
 Area category method 63.48
 Activity method 63.49

LIGHTING POWER ADJUSTMENT FACTOR . Table 63.45

LIGHTING POWER BUDGET 63.49 (5)

LIGHTING POWER CONTROL CREDITS 63.45 (2)

LIGHTING POWER DENSITY 63.47, 63.48, 63.49(5)

LINTEL 51.03(5)

LISTED SPACE AREA, Definition 63.05 (39)

LIVING UNIT, Definition 51.01(76a)

LOADS, DEAD 53.10

LOADS, DESIGN COMBINATIONS 53.15

LOADS, FOOTINGS AND FOUNDATIONS 53.20

LOADS, LIVE:
 Concentrated 53.11
 Cranes 53.13
 Floor loads, occupancy 53.11
 Footings 53.11
 Impact 53.13
 Posting loads 54.17
 Reduction of loads 53.11
 Roof 53.11
 Sidewalks 53.11

Snow 53.11
 Soil 53.21
 Tests 53.21
 Wind 53.12

LOADS, PILES 53.24

LOADS, RAILINGS 51.14(3), 51.161, 62.28

LOADS, WIND 53.12

LOBBY:
 Definition 51.01(77)
 Theaters 55.15

LOCAL REGULATIONS 50.06

LOCKS ON DOORS 51.15(3), 54.06(3), 58.20

LODGING HOUSES ch. Comm 57

LOT LINE, Definition 51.01(78)

LOT LINES, Plot plan required 50.12(3)

LPB (See lighting power budget)

LPD (See lighting power density)

LS (See listed space area)

LUMBER 53.61

LUMEN MAINTENANCE 63.45 (2), 63.51 (6)
 Definition 63.05 (40)

LUMINAIRES,
 Definition 63.05 (41)
 Portable 63.45
 Track lighting 63.45 (4)

M

MAINTENANCE:
 Assembly halls 55.50
 Automatic fire sprinklers 51.23(6), 52.01(2)
 CBRF's 61.24
 Fire alarms 51.24(10)
 Fire extinguishers 51.22(3)
 Exits 52.21
 General 52.22, 52.23
 HVAC systems 64.52
 Public schools 52.22 note
 Smoke detectors 51.245(3)
 Standpipes 51.21(8)
 Toilet rooms 52.64

MAJOR APPARATUS, Definition 51.01(79)

MANSARDS (Wall construction behind) 51.03(1), (2) (3)
 [Also refer to decorative combustible materials .. 51.02(15)]

MANUAL, Definition 63.05 (42)

MANUFACTURING, OCCUPANCY ch. Comm 54

MASONRY CONSTRUCTION:
 Aggregate 51.045, 53.312
 Basement walls 53.322
 Block 53.311
 Brick 53.311
 Cast stone 53.311
 Cavity walls 53.321, 53.322
 Cementitious materials 53.314
 Ceramic 53.36
 Ceramic veneer 53.36
 Change in thickness 53.34
 Chases 53.34

Chimney walls	53.321	MINIMUM DESIGN LOADS	53.10, 53.11
Clay or shale units	53.311	MOBILE TRAINING CLASSROOMS	56.40-56.46
Composite	53.322	MOISTURE MIGRATION	63.11 (4)
Concrete units	53.311	MONUMENTAL STAIRS	54.08, 55.09
Construction	53.33	MORTAR	53.312
Corbeling	53.34	MOTELS	ch. Comm 57
Definition	51.01(80)	MOTOR VEHICLE GARAGES	ch. Comm 59
Design, empirical	53.322	MOTORS	
Design, engineered	53.323	Minimum efficiency	63.32
Details, construction	53.34	Multispeed	63.32 (f)
Erection, general	53.01	Sizing	63.53 (2)-(4)
Fire resistance materials	51.043-51.045	MULTIBUILDING FACILITIES	63.41
Fire resistance ratings	51.043	MULTIPLE-ZONE SYSTEMS	63.27
Glass blocks	51.048	MULTISCENE DIMMING SYSTEM, Definition .	63.05 (46)
Grout	53.313	MUSEUMS	ch. Comm 56
Gypsum, mortar	53.312		
Gypsum units	53.311	N	
Hollow	53.311	NAILS	53.63
Jointing	53.322, 53.36	NATIONAL FENESTRATION RATING	
Lateral support	53.322	COUNCIL	63.18 (2) (b)
Materials	53.31	NET AREA,	
Mortar	53.312	Definition	51.01(83)
Piers	53.322	NONBEARING PARTITIONS OR WALLS:	
Protected	51.03(5)	Definition	51.01(84)
Protection against freezing	53.33	Fire protective requirements	51.03
Reinforced, ties and anchors	53.316	Fire resistance ratings	51.03
Stone	53.311	Genera	151.02
Terra cotta	53.36	Masonry	53.17, 53.322
Tests	53.35	NONCOMBUSTIBLE CONSTRUCTION	
Types	53.321	Definition	51.01(85)
Units	53.311	NURSING HOMES:	ch. Comm 58 subch. I
Unprotected	51.03(5)	Definition	51.01(86a)
Veneered walls	53.36		
Wall thickness	53.322	O	
Water	53.315	OBSTRUCTION-PROHIBITED:	
Working stresses	53.311, 53.312	Aisles	52.21
MASS WALLS	63.15 (3)	Exits	51.15(2)
Definition	63.05 (43)	Horizontal exit	51.19(2)
MASS WALL POSITION,		Stairways	51.16(3)
Definition	63.05 (44)	OCCUPANCY OR USE, Definition of	51.01(87)
MATERIALS, METHODS AND DEVICES,		VARIANCE, PETITION FOR	50.25
Approval of	50.19	OCCUPANCY CHAPTERS:	
MEANS OF EGRESS (See EXIT)		CHILD DAY CARE FACILITIES (including all public and	
Definition	51.01(80a)	private day care centers accommodating children, including	
MECHANICAL VENTILATION(See VENTILATION)		all buildings, or parts of buildings, used as day care	
MEDICAL AND CLINICAL AREA,		facilities)	Chapter Comm 60
Definition	63.05(45)	COMMUNITY-BASED RESIDENTIAL FACILITIES	
MENTAL HOSPITALS	ch. Comm 58 subch. I	(CBRF) (including facilities providing care, treatment and	
METAL BUILDINGS	63.18 (2)	services to 9 through 20 unrelated adults located in	
MERCANTILE, Occupancy	ch. Comm 54	existing buildings and sheltered facilities for battered	
MEZZANINE, MEZZANINE FLOOR:		women)	Chapter Comm 61
Definition	51.01(82)		
Number of stories	51.02(14)		
MINI-STORAGE BUILDINGS:	62.995		
Definition	51.01(82a)		

FACTORIES, OFFICE AND MERCANTILE BUILDINGS
 (including all factories and workshops, office buildings, telegraph and telephone offices, mercantile establishments where commodities are bought or sold, taverns, warehouses, railroad stations, exhibition buildings, and places where not more than 100 persons assemble for recreation, entertainment, worship, or dining purposes) Chapter Comm 54
HAZARDOUS OCCUPANCIES (including all garages [except private garages], filling stations and related buildings and structures, automobile tire or battery shops, and other occupancies where flammable or combustible liquids or other hazardous materials are manufactured, processed, stored, or otherwise handled) Chapter Comm 59
HEALTH CARE FACILITIES AND PLACES OF DETENTION (including hospitals, nursing home reformatories and lock-ups) Chapter Comm 58
RESIDENTIAL OCCUPANCIES (including all apartment buildings, garden apartments, row houses, town houses, condominiums, rooming houses, hotels, motels, dormitories, convents, monasteries, homes for the aged, community-based residential facilities, sheltered facilities for battered women, and other places of abode ... Chapter Comm 57
SCHOOLS AND OTHER PLACES OF INSTRUCTION (including all public and private schools, universities, colleges, academies, seminaries, libraries, museums and art galleries, including all buildings or parts of buildings used primarily for instructional purposes) ... Chapter Comm 56
SPECIALTY OCCUPANCIES (including open parking structures, radio and television transmitting and receiving antenna, tents, outdoor theaters, assembly seating facilities, greenhouses, pedestrian access structures connecting buildings) Chapter Comm 62
THEATERS AND ASSEMBLY HALLS (including all buildings, or parts of buildings, containing an assembly hall having a stage which may be equipped with curtains or permanent or movable scenery, or which is otherwise adaptable to the showing of plays, operas, motion pictures, or similar forms of entertainment; and all buildings, or parts of buildings other than theaters, which will accommodate more than 100 persons for entertainment, recreation, worship or dining purposes) Chapter Comm 55
OCCUPANCY SEPARATION 51.08 (1)
OCCUPANT LOAD:
 Calculating capacities . 54.06, 55.06, 56.07(2), 57.04, 58.12, 58.46, 59.16, 60.11
 Exit width 51.15(6)
OCCUPANT SENSORS 63.45 (2), 63.51 (4)
 Definition 63.05 (47)
OCCUPIED, Definition 51.01(88)
OIL STORAGE 64.23(5)
OPAQUE AREAS, Definition 63.05 (48)
OPAQUE WALL 63.05 (48), 63.15 (3), 63.18 (3) (c)
OPENINGS:
 Combustion air 64.09
 Exterior walls 51.02 (4), 51.03
 Fire department access 52.02
 Motion picture projection booths 55.39
 Protected with fire doors or windows 51.047, 51.048
 Rated construction 51.045, 51.049
 Stairways or shafts 51.02(11), 51.03
OPEN PARKING STRUCTURES ch. Comm 62 subch. I
OPEN SPACES, Definition 51.01(89)
OPEN WEB STEEL JOIST 53.52
ORIEL WINDOWS (Bay) 51.03
ORNAMENTAL CHANDELIERS, DEFINITION . 63.05 (49)
ORPHANAGES ch. Comm 57
OUTDOOR OPENINGS, Definition 51.01(90)
OUTDOOR THEATERS 62.52-62.62
OUTLET (SUPPLY OPENING), Definition 51.01(93)
OUT-PATIENT SURGICAL FACILITIES:
 Definition 51.01(93a)
 HVAC systems 64.57
OUTSIDE AIR, Definition 51.01(94)
OUTSIDE AIR INTAKE, Definition 51.01(95)
OUTSIDE STAIRS 51.16, 51.20, 54.03(1)
OWNER:
 Application for permit 50.12
 Responsibility 50.11

P

PANEL WALL, Definition 51.01(96)
PANIC HARDWARE 51.15(3)
PARAPET WALL 51.02(12)
PARITY, REST ROOM 55.32, 54.12, 52.50, 62.58
PARKING GARAGE, OPEN DECK .. ch. Comm 62 subch. I
PARKING LOTS 63.43
PARKING SPACES, for physically disabled 52.04(3)
PART LOAD PERFORMANCE 63.20 (3)
PARTITION, Definition 51.01(97)
PARTY WALL, Definition 51.01(98)
PASSAGEWAYS 52.21, 54.07, 56.09, 57.09, 59.15, 60.22, 60.33, 61.12
PEDESTRIAN ACCESS STRUCTURES 62.97
PENALTIES AND VIOLATIONS 50.26
PENTHOUSE: 51.03
 Definition 51.01(99)
PERIMETER ZONES 63.26 (2)
PERMITS, BUILDING:
 Agent municipalities 50.21
 Plan approval 50.12
 Footing and foundations 50.13
 Local 50.06
 To start construction 50.14
PETROLEUM STORAGE (Refer to ch. Comm 10)
PEWS, Width 55.13
PHOTOCELL SENSORS 63.51 (7)
PHYSICALLY DISABLED,
 General requirements 52.04

PIERS:	POWER PLANT, Occupancy ch. Comm 54
Definition 51.01(100)	PRECISION COMMERCIAL OR INDUSTRIAL WORK,
Masonry 53.322	Definition 63.05 (50)
PILASTER, Masonry:	PRESSURE TREATED WOOD:
Definition 51.01(101)	Fire retardant, definition 51.01(52)
General requirements 53.322	For decay prevention 53.63
PILES 53.24	PRESTRESSED CONCRETE 53.40
PIPE:	PRISON, Occupancy 58.40-58.69
Duct 64.33	PRIVATE DRIVEWAYS, WALKWAYS, AND PARKING
Insulation 63.29 (2)	LOTS, Definition 63.05 (51)
Smoke 64.49	PRIVATE GARAGE,
Steam or hot water 64.23	Definition 59.01(5)
PIPING, HAZARDOUS, Definition 51.01(102)	PROJECTION BOOTH 55.39
PLACE OF ABODE, Definition 51.01(102a)	PROPERTY, ADJOINING, Protection of 53.26
PLACE OF EMPLOYMENT, Definition 51.01(102b)	PROPERTY LINE, Definition 51.01(104)
PLACES OF DETENTION: ch. Comm 58 subch. II	PROSCENIUM 55.21, 55.22, 55.23
Class of construction 58.42	PROTECTION AGAINST DECAY AND TERMITES 53.63
Exiting 58.47-58.58	PROTECTION OF VERTICAL SHAFTS 51.02(11), 51.03,
Fire detection and suppression 58.62-58.65	54.08, 55.09, 56.10, 57.08, 58.23(1), 58.25, 58.61, 59.17,
Guard towers and observation stations 58.67	60.34, 62.27
Isolation of hazards 58.61	PROTECTION OF WALL OPENINGS 51.047, 51.048,
Protection of openings 58.59-58.60	51.049
Sanitary facilities 58.66	PUBLIC BUILDING, Definition 51.01(104a)
Separation from other occupancies 51.08	PUBLIC DRIVEWAYS, WALKWAYS, AND PARKING
PLANS:	LOTS, Definition 63.05 (52)
Examination and approval 50.12	PUBLIC SEWERS, Connection with 52.62
Fee (Also refer to ch. Comm 2) 50.20	PUBLIC THOROUGHFARE Definition 51.01(105)
Plot 50.12	
Prepared outside Wisconsin 50.08	R
Required for permit to start 50.14	R (See thermal resistance)
PLASTICS, FOAM 51.06	R-VALUES 63.05 (67)
PLASTICS, LIGHT TRANSMITTING 51.065	RADIATION AND CONVECTION EQUIPMENT 64.21
PLATFORMS:	RADIO ANTENNA 62.35
Guardrails 51.162	RAILING (See HANDRAILS)
Rescue platforms 54.03, 57.05	RAMPS:
Stairway landings 51.16(5)	Accessibility for physically disabled 52.04
PLENUM 64.41	Factories, office and mercantile buildings 54.03
PLOT PLAN, Required 50.12(3)	General requirements 51.16
PLYWOOD 53.61	Open parking structures 62.26
POLE BUILDING 51.03(6)	Residential buildings 57.05
POLE FOUNDATIONS 53.28	Schools and other places of instruction 56.06
POLICE STATION, Occupancy ch. Comm 54 or 58	Theaters and assembly halls 55.08
subch. II	RANGE HOODS, Ventilating 64.67
PORCH, Definition 51.01(103)	RECOOLING, Definition 63.05 (53)
PORTLAND CEMENT, Masonry mortar 53.35	RECOVERED ENERGY 63.27 (2) (c), 63.31 (2) (c)
POSTING:	Definition 63.05 (54)
Floor loads 54.18	
Occupancy capacities 55.06	

RECREATION HALLS ch. Comm 54 or 55

RECYCLABLE MATERIAL, Definition 51.01(105e)

RECYCLING SPACE 52.24

REDUCED FLICKER OPERATION, Definition .. 63.05 (55)

REDUCTIONS, Live loads 53.11

REFORMATORIES ch. Comm 58 subch. II

REFRIGERATION 64.10

REHEATING, Definition 63.05 (56)

REINFORCED CONCRETE 53.40

REINFORCED GYPSUM CONCRETE 53.41

REINFORCED MASONRY 53.323

REINFORCEMENT BARS 53.316, 53.40

RELOCATABLE CLASSROOMS 56.30

REMODELING AND ALTERATIONS:

 Accessibility 52.04

 Code application 50.03

 Design 50.07

 Definition 51.01(105a)

 Plan review 50.12

REPAIR:

 Assembly halls 55.50

 CBRF's 61.24

 Exits 52.21

 General 52.22, 52.23

 Repair garage 59.10

 Smoke detectors 51.245(3)

 Toilet rooms 52.64

REQUIRED, Definition 51.01(106)

REQUIRED EXIT CORRIDOR

 Definition 51.01(106a)

RESCUE PLATFORMS 54.03, 57.05

RESET, Definition 63.05 (57)

RESIDENCES, One- and two-family exempt 50.04
(Also refer to Uniform Dwelling Code)

RESIDENTIAL OCCUPANCIES: ch. Comm 57

 Allowable height and area 57.02

 Construction 57.01

 Fire alarms 57.17

 Fire detection 57.16, 57.165

 Fire protection 57.016, 57.15

 Habitable rooms below grade 57.11

 Isolation of hazards 51.08 (2)

 Number, location, capacity and type of exit 57.03-57.10

 Rowhouse 57.19

 Sanitary facilities 57.12

 Windows 57.13

REST ROOMS (See SANITARY FACILITIES)

RESTAURANTS ch. Comm 54 or 55

RESTRAINED SUPPORT, Definition 51.01(107)

RETAINING WALL: 53.27, 53.34

 Definition 51.01(108)

RETROACTIVITY 50.02, 51.047(6), 56.03(2), 57.16,
57.165, 61.14, 61.26, 63.001

RETURN (or EXHAUST OPENING)

 Definition 51.01(109)

REVOLVING DOORS 51.15

RISERS, For stairways 51.16

ROADWAY, Definition 51.01(110)

ROOF, ROOF CONSTRUCTION:

 Access to attic or roof 51.02, 51.20, 57.19

 Anchorage 53.12

 Coverings 51.02, 51.05

 Definition 51.01(111)

 Drainage 53.11

 Fire-resistance ratings 51.043

 Fire-resistive construction 51.03

 Heavy timber 51.03(4)

 Joists (See JOISTS)

 Live loads 53.11

 Mansard roofs 51.03

 Materials, roofing 51.02, 51.05

 Nailing schedule 53.63

 Over stages 55.24

 Parapets 51.02(12), 53.34

 Scuttles 51.02(18)

 Sheathing 53.61

 Skylights 51.065

 Thermal performance 63.12,
63.15 (4), 63.18 (1), 63.18 (2), 63.18 (3) (a)

 Wind loads 53.12

 Wood frame construction 53.60-53.63

ROOF COVERING, Definition 51.01(112)

ROOF COVERINGS 51.02, 51.05

ROOM, Definition 51.01(114)

ROOM, SPACE HEATERS 64.22

ROOMING HOUSE ch. Comm 57

ROW HOUSE: ch. Comm 57

 Definition 51.01(114a)

 General 57.19

RUBBLE MASONRY 53.322

S

SAND:

 Bearing soil capacity 53.21

 Concrete 53.40

 Mortar 53.12

SANITARIUM, Occupancy ch. Comm 58 subch. I

SANITARY FACILITIES:

 Assembly halls 55.32

 Assembly seating facilities 62.79

 CBRF's 61.17

 Day care centers 60.15

 Detention facilities 58.68

 Educational facilities 56.16

 Factory, office, mercantile 54.12

 For physically disabled 52.04 (4), 52.04 (6), 52.04 (8),
52.041, 52.042

 Health care facilities 52.041, 52.042, 58.32

 Garages, storage or repair 59.20

 General requirements 52.50, 52.52, 52.53, 52.54, 52.55,
52.56, 52.57, 52.58, 52.59, 52.60, 52.61, 52.63, 56.64

 Outdoor theaters 62.58

 Residential facilities 57.12

- Tents 62.48
- SCHOOLS ch. Comm 56
- SCONCE, Definition 63.05 (58)
- SCOPE
- Building envelope 63.10
 - Lighting 63.40
- SCOPE OF CODE 50.02
- SC 63.15 (2) (b), 63.18 (4)
 - Definition 63.05 (59)
- SCUTTLE 51.02(18), 57.19
- SEATS, SEATING:
- Definition 62.10
 - Grandstands, bleachers, places of assembly 62.76
 - Physically disabled 52.04
 - Schools, auditoriums, gymnasiums 56.13, 56.14
 - Theaters, assembly halls 55.13
- SEMINARIES chs. Comm 56/57
- SEPARATION:
- Class of construction 51.02(20)
 - Occupancies 51.08 (1)
- SEPTIC TOILETS 52.62
- SERVICE STATIONS ch. Comm 59
- SERVICE WATER HEATING
- Circulating systems 63.29 (2)
 - Equipment efficiencies 63.20 (4), 63.20 (5)
 - Heat traps Table 63.29-1
 - Insulation 63.29 (2)
 - Non-circulating systems 63.29 (2)
- SETBACK, Definition 51.01(115)
- SHADING COEFFICIENT 63.15 (2) (b)
- Definition 63.05 (59)
 - Manufacturer's literature 63.18 (4)
- SHAFT:
- Definition 51.01(116)
 - Rated 51.02(11), 51.03
- SHALL, Definition 51.01 (117)
- SHELL BUILDINGS 63.05 (61), 63.15(2) (b)
- Definition 63.05 (60)
- SHORING, Adjoining foundations 53.26
- SHUTTERS, FIRE 51.047, 64.42
- SIDEWALKS, HEATED 63.19
- SIGNS:
- Barrier-free 52.04(3)52.04(10)
 - Capacity of occupancy 54.18, 55.06(4)
 - Clearance limitation 62.25
 - Definition 51.01(118)
 - Exit signs 51.15(5)
 - Floor loads 54.17
 - Toilet rooms 52.52
- SIMPLE SUPPORT, Definition 51.01(119)
- SIMULTANEOUS HEATING AND COOLING 63.27
- SINKS (See LAVATORIES)
- SIZING, HVAC systems 63.23
- SKATING RINKS (Indoor) ch. Comm 54 or 55
- SKYLIGHTS 51.065, 63.12, A63.12
- SKYWALKS 62.97
- SLAB-ON-GRADE FLOORS 63.15 (5), 63.18 (3)
- SLEEPING AREA:
- Definition 51.01(119a)
 - CBRF's 61.14
 - Residential occupancies 57.16
- SMOKE BARRIER:
- Detention facilities 58.64
 - Health care facilities 58.27
- SMOKE CONTROL SYSTEM - ATRIUMS 52.07(3), 52.07(12)
- SMOKE DETECTION:
- CBRF's 57.165, 61.14
 - Educational facilities 56.03
 - Day care centers 60.25
 - General requirements 51.245
 - Residential facilities 57.16
- SMOKE DETECTOR, Definition 51.01(119b)
- SMOKE PIPES, SMOKESTACKS AND BREECHING 64.45, 64.46, 64.47, 64.48, 64.49, 64.50
- SMOKEPROOF STAIR ENCLOSURE:
- Detention facilities 58.51
 - Health care facilities 58.09
 - General requirements 51.17
- SOIL 53.20
- SOLID FUEL EQUIPMENT:
- Definition 51.01(119c)
 - Health care facilities 58.24
 - General requirements 64.20, 64.21, 64.22
- SPACE HEATERS 64.22(5)
- Definition 51.01(120)
- SPANDREL, Definition 51.01(120a)
- SPECIALTY EVENT CENTER 51.01(119g)
- SPECIALTY OCCUPANCIES: ch. Comm 62
- Assembly seating facilities ch. Comm 62 subch. V
 - Greenhouses ch. Comm 62 subch. VI
 - Open parking structures ch. Comm 62 subch. I
 - Outdoor theaters ch. Comm 62 subch. IV
 - Pedestrian access structures ch. Comm 62 subch. VII
 - Television and radio antenna ch. Comm 62 subch. II
 - Tents ch. Comm 62 subch. III
- SPECIFICATIONS,
- Plan review 50.12(3), 50.12(4)
- SPECULATIVE BUILDINGS 63.15 (2) (b)
- Definition 63.05 (61)

SPEED OF ACCESS (see PARITY)

SPIRAL STAIRS 51.16, 54.03, 57.07

SPRINKLERS:

- Definition 51.01(7a)
- Health care facilities 58.24, 58.25, 58.29
- High rise buildings 52.01
- Housing for the elderly 57.016(2)
- Low rise buildings 52.011, 52.012, 52.013
- School basements 56.03
- Specifications 51.23

STABILITY 53.16

STADIUMS ch. Comm 62 subch. V

STAIRS AND STAIRWAYS:

- Curved 51.16(6)
- Design features 51.16
- Enclosure 51.02(11), 51.03, 54.08, 55.09, 57.08, 58.06, 58.50, 59.17, 60.23, 60.34, 61.12, 62.27
- Exterior 51.16, 51.20, 54.03
- Fire escape 51.20
- Interior enclosed stairs 51.18
- Identification 51.165
- Spiral 51.16(7), 54.03, 57.07
- Smokeproof tower 51.17, 58.09, 58.51

STANDARDS AND SPECIFICATIONS ADOPTED ... 51.25

STANDPIPES:

- Assembly halls 55.33(2)
- Detention facilities 58.63(2)
- Educational facilities 56.20(2)
- Factory, office, mercantile 54.15(2)
- Health care facilities 58.28
- Garages, storage or repair 59.23
- General requirements 51.21
- Open parking structures 62.30
- Outdoor theaters 62.58
- Residential facilities 57.15(2)

STEAM PIPES AND HOT WATER PIPES 64.23

STEEL CONSTRUCTION:

- Aluminum 53.54
- Caissons 53.24
- Certification and identification 53.50
- Fabrication 53.50
- Fire-resistance ratings 51.043
- Joists, open web construction 53.52
- Marking 53.50
- Metal frame protected construction 51.03(3)
- Metal frame unprotected construction 51.03(6)
- Piles 53.24
- Reinforcing 53.316
- Stainless steel 53.55
- Structural steel 53.50
- Welding 53.53

- STEPS, Definition 51.01(120b)
- STONE MASONRY 53.311, 53.322
- STORAGE OF FLAMMABLES (Refer to ch. Comm 10)
- STORAGE GARAGE ch. Comm 59
- STORIES, NUMBER OF:

 - Definition 51.01(121)
 - Determination 51.02(14)

- STORY, Definition 51.01(122)
- STOVES (See RANGES)
- STREET:

 - Definition 51.01(124)
 - Location 54.01, 55.04, 57.02, 59.12

- STRUCTURAL REQUIREMENTS ch. Comm 53
- STRUCTURE, Definition 51.01(125)
- SUPERVISION 50.10
- SUPPORT:

 - Restrained, definition 51.01(107)
 - Simple, Definition 51.01(119)

- SUPPORT AREA, Definition 63.05 (62)
- SYSTEMS STANDARDS METHOD 63.14, 63.16

T

- TANDEM WIRING 63.53

 - Definition 63.05 (63)

- TASK LIGHTS 63.45
- TASK ORIENTED LIGHTING, Definition 63.05 (64)
- TEMPERATURE, DESIGN 64.04, 64.05
- TEMPERED AIR, Definition 51.01(128)
- TEMPERED OUTSIDE AIR

 - Definition 51.01(129)

- TEMPORARY BUILDINGS OR STRUCTURES 50.04
- TENTS ch. Comm 62 subch. III
- TERRACES, Definition 51.01(130)
- TESTING LABORATORIES 51.044
- TESTS:

 - Diversified, foam plastic 51.01(3a)
 - Fire alarm 51.24(5)
 - Fire doors 51.047(1)
 - Fire windows 51.048(1)
 - Fire-resistance ratings of assemblies 51.043
 - Heating equipment 64.20(1)

- THEATERS AND ASSEMBLY HALLS ch. Comm 55

THERMAL BARRIER	51.06(3)	TRUSSES, WOOD	53.62
THERMAL BREAK, Definition	63.05 (65)	TYPES OF CONSTRUCTION	51.03
THERMAL CONDUCTANCE, Definition	63.05 (66)		
THERMAL ENVELOPE PERFORMANCE	63.14	U	
Component Standards	63.15	U (See thermal transmittance)	
System Standards	63.16	U _O (See thermal transmittance, overall)	
Calculation Procedures	63.18	U-VALUE	
THERMAL MASS	63.15 (3)	Calculation methods	63.18
THERMAL RESISTANCE, Definition	63.05 (67)	Doors	63.18 (2) (a) 3.
THERMAL TRANSMITTANCE, Definition	63.05 (68)	Fenestration	63.18 (2) (b), 63.15(2) (c)
THERMAL TRANSMITTANCE, OVERALL, Definition	63.05 (69)	Floors over unconditioned space ...	63.15 (4), 63.18 (3) (b)
THERMOSTAT, Definition	63.05 (70)	Opaque assembly	63.18 (2) (a)
THERMOSTAT CONTROLS	63.26	Opaque walls	63.15 (3), 63.18
THERMOSTAT SETPOINT	63.26 (2)	Parallel path correction factors	63.18 (2) (a)
THROW DISTANCE, Definition	63.05 (71)	Roofs	63.18
TIMBER:		Skylights	63.12
Glued-laminated structure	153.61	Zone method	63.18 (2) (a)
Type of construction	51.03(4)	UNCONDITIONED SPACE, Definition	63.05 (72)
TIME CLOCKS	63.26 (3), 63.50 (4), 63.50 (6)	UNDERPINNING	53.26
TIRE SHOPS	ch. Comm 59	UNIT HEATERS	64.21
TOE BOARDS	54.105	Definition	51.01(133)
TOILET COMPARTMENTS:		UNLISTED SPACE, Definition	63.05 (73)
Accessibility for physically disabled	52.04(8)	UNIT POWER DENSITY	63.49 (1)
Floors	52.57	URINALS	52.59(1), 52.60(2)
Sizes	52.59(2), 52.59(3)		
Walls and ceilings	52.58	V	
TOILET ROOMS	51.01(130g), 52.64, 58.66, 57.12	VAPOR BARRIER	63.11 (4)
TOILETS:		VARIABLE AIR VOLUME HVAC SYSTEM, Definition	63.05 (74)
Chemical	52.62	VARIANCE	50.25
Outdoor	52.63	VAV HVAC (See variable air volume HVAC system)	
TOWERS	ch. Comm 62 subch. II	VENEERED WALL:	
TOWNHOUSES,		Anchorage masonry units	53.36
Definition	51.01(130a)	Definition	51.01(134)
TRACK LIGHTING	63.45 (4)	VENTILATION:	
TRASH COLLECTION ROOM:		Air-cleansing devices	64.16
Individual rooms	52.012	Air movement and distribution	64.15
Recyclable materials, collection, separation and storage	52.24	Automatic controls	64.17
TREADS, STAIRS	51.16	Combustion air	64.09
TREATED WOOD (Fire Retardant)		Contamination	64.18
Definition	51.01(131)	Definition	51.01(136), 64.12(6)
TRIM	51.02(15), 51.07	Exhaust ventilation systems	64.08
		Gravity exhaust ventilation, definition	51.01(137)
		Location of intakes	64.19
		Mechanical ventilation, definition	51.01(138)
		Mechanical ventilation systems	64.06
		Natural ventilation systems	64.07
		Occupancy requirements	64.05(2)
		Tempered air	64.13
		Tempered outside air	64.14
		VENTILATOR, GRAVITY SIPHON TYPE	64.08(5)
		VENTS:	
		Chimney and connectors	64.50
		Factory-built	64.48
		Gas	64.49
		General requirements	64.45
		Masonry	64.46
		Metal	64.47

VERTICAL EXIT, Definition	51.01(139)	WELDER, Certification	53.53
VERTICAL OPENINGS:		WELDING	53.53
Atriums	52.07	WELL EFFICIENCY, Definition	63.05 (77)
Protection	51.02(11)	WIDTH, Aggregate exit	51.15(6)
Ratings – types of construction	51.03	WIND LOADS DESIGN	53.12
VESTIBULE OPENINGS,		WINDOW, Definition	63.05 (78)
Ventilation	64.07(2)	WINDOW AREA, Definition	63.05 (79)
VLT (See visible light transmittance)		WINDOW WALL RATIO	63.15 (2)
VISIBLE LIGHT TRANSMITTANCE,		Definition	63.05 (80)
Definition	63.05 (75)	WINDOWS:	
VIOLATIONS AND PENALTIES	50.26	Fire	51.048
VOLUME, Definition	51.01(139a)	Natural light	57.13, 58.03, 58.45, 60.13, 61.15
		Ventilation	57.13, 58.03, 58.45, 61.15, 64.07
W		WINDOWLESS FLOOR LEVELS	52.012, 52.02
WALL HEAT CAPACITY, Definition	63.05 (76)	WIRED GLASS:	
WALLS	63.18 (33), 63.18 (3) (c)	Fire-resistive doors and windows	51.047, 51.048
WALLS ADJACENT TO UNCONDITIONED		WIRING, ELECTRICAL:	
SPACE	63.15 (4)	CBRF's	61.25
WALLS AND PARTITIONS:		General Requirements	52.20
Anchorage (See ANCHORAGE, ANCHORS)		(See also Wis. Electrical Code ch. Comm 16)	
Assemblies, fire-resistance	51.042, 51.043, 51.045	WOOD BLOCKING IN NONCOMBUSTIBLE	
Exterior	51.02(4), 51.03	ASSEMBLIES	51.02(23)
Fire division	51.02 (13)	WOOD BURNING STOVES:	
Foundation	53.322	Definition	51.01(119c)
Glass block	51.048	Health care facilities	58.24
Masonry (See MASONRY CONSTRUCTION)		General requirements	64.21, 64.22
Openings, fire protections	51.047, 51.048, 51.049	WOOD CONSTRUCTION:	
Parapets	51.02 (12)	Beams	53.60, 53.61, 53.62, 53.63
WAREHOUSES:	ch. Comm 54	Columns	53.60, 53.61, 53.62, 53.63
Definition	51.01 (153a)	Design	53.60
Freezer warehouses	51.06 (6)	Erection	53.60
Mini-storage buildings	62.995	Fire-resistance ratings	51.043
WARM-UP FACTORS	63.23 (7)	Fire retardant-treated, definition	51.01(52)
WASTE OIL BURNING EQUIPMENT	64.21	Foundations	53.64
WATER CLOSETS:		Frame	51.03(7), 51.03(8)
Accessibility for physically disabled	52.04(4), 52.04(6),	Plywood	53.60
52.04(8)		Trim	51.02(15)
Enclosure	52.59	Trusses	53.62
General requirements	52.60(1)	Y	
		YARD, Definition	51.01(154)
		Z	
		ZONE, Definition	63.05 (81)
		ZONE CONTROLS	63.27
		ZONE TEMPERATURE CONTROLS	63.26 (2)